

FIELD PROGRAMMER USER'S GUIDE

Description

The Silicon Laboratories Si50x-FPB1-CUST kit contains the hardware and software needed for field programming the Si501/2/3/4 Single/Dual/Quad/Any-Frequency single-wire programmable CMEMS® (CMOS + MEMS) oscillators. The Field Programmer Board (FPB) can be run on a USB-equipped PC.

Features

- Field programming of Silicon Laboratories' Si501/2/3/4 CMEMS oscillators
- Windows-compatible software control and device programming

Field Programmer Software

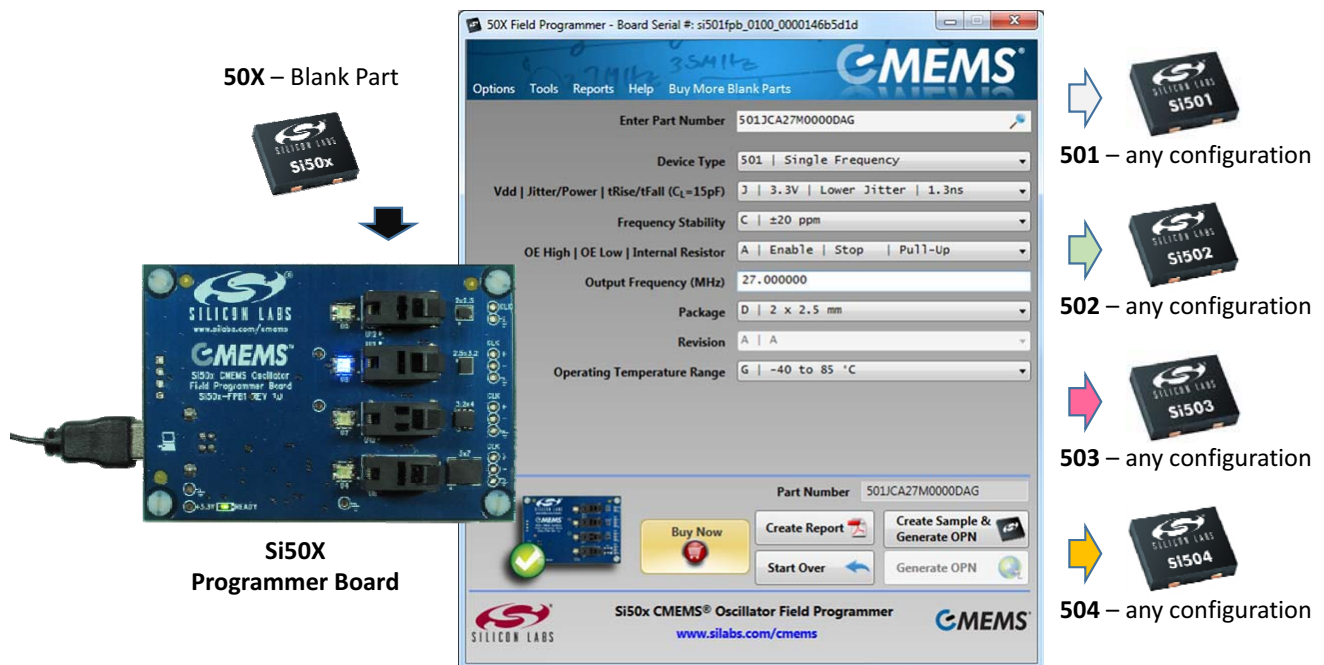

50X – Blank Part

Si50x

Si50X Programmer Board

50X Field Programmer - Board Serial #: si501fpb_0100_0000146b5d1d

CMEMS

Options Tools Reports Help Buy More Blank Parts

Enter Part Number: 501JCA27M0000DAG

Device Type: 501 | Single Frequency

Vdd | Jitter/Power | tRise/tFall (C_L=15pF): J | 3.3V | Lower Jitter | 1.3ns

Frequency Stability: C | ±20 ppm

OE High | OE Low | Internal Resistor: A | Enable | Stop | Pull-Up

Output Frequency (MHz): 27.000000

Package: D | 2 x 2.5 mm

Revision: A | A

Operating Temperature Range: G | -40 to 85 °C

Part Number: 501JCA27M0000DAG

Buy Now Create Report Create Sample & Generate OPN Start Over Generate OPN

501 – any configuration

502 – any configuration

503 – any configuration

504 – any configuration

SILICON LABS **CMEMS**

Si50x CMEMS® Oscillator Field Programmer www.silabs.com/cmems

Si50x-FPB1-CUST

1. Quick Start

1. Install the Si50x CMEMS® FPB Software and driver.
2. Download FPB GUI Software from www.silabs.com/Si50x-FPB1
3. Launch the Field Programmable Oscillator Software by selecting Start → All Programs → Silicon Laboratories → Si50x Field Programmer.
4. Install blank Device Under Test (DUT) to be programmed and follow the Graphical User Interface (GUI) directions.

2. Introduction

This Si50x-FPB1 User's Guide documents immediately useful information for programming blank devices (DUTs) and additional reference details in support of the Si50x-FPB1(FPB). This document also describes the operation of the Silicon Laboratories Si50x-FPB1 field programmer kit. The Si50x-FPB1 kit refers to the field programmer board hardware and software intended for field programming of the Si501, 502, 503, and 504 CMEMS oscillators. The term, "field programming" as it is used in this document refers to writing the write-once configuration registers in Non-Volatile Memory (NVM). The NVM controls the configuration of the device on powerup.

2.1. Kit Contents

The Si50x-FPB1 kit contains the following:

- Si50x Field Programmer Board
- USB Type B retractable cable
- 5 blank 2025 parts
- 5 blank 2532 parts
- 5 blank 3250 parts

Note: The FPB GUI must be downloaded from www.silabs.com/Si50x-FPB1. It is not included in the FPB Kit.

The software components run on a USB-equipped PC and are described in detail in Section "11. Software Guide" The Si50x-FPB1 field programmer board can be used to program one Si50x CMEMS oscillator at a time when installed in 1 of 4 differently sized sockets.

2.2. FPB-EVB GUI Quick Start Guide

The screenshot shows the '50X Field Programmer' interface. At the top, there's a menu bar with 'Options', 'Tools', 'Reports', 'Help', and 'Buy More Blank Parts'. The main area contains several configuration fields: 'Enter Part Number' (503ACA000641DAG), 'Device Type' (503 | Quad Frequency), 'Vdd | Jitter/Power | Rise/Fall (CL=15pF)' (A | ALL | Lower Power | 0.7ns), 'Frequency Stability' (C | ±20 ppm), 'Internal Resistor' (A | Pu11-Up), 'Output Frequency #1 (Strong High) (MHz)' (0.032), 'Output Frequency #2 (Weak High) (MHz)' (20), 'Output Frequency #3 (Weak Low) (MHz)' (24), 'Output Frequency #4 (Strong Low) (MHz)' (27), 'Package' (D | 2 x 2.5 mm), 'Revision' (A | A), and 'Operating Temperature Range' (G | -40 to 85 °C). At the bottom, there's a 'Part Number' field (503ACA000641DAG) and a 'Buy Now' button. Below that are buttons for 'Create Report', 'Create Sample & Generate OPN', 'Start Over', and 'Generate OPN'. A green checkmark icon is visible next to the 'Buy Now' button.

Type an existing OPN here and all existing OPNs display below. Hit <enter> to deploy OPN configuration into option drop-down boxes.

Select device : Si501/Si502/Si503/Si504. The available options change according to the selected device.

Package selection corresponds to a specific socket shown by lighted LED.

Revision is not selectable because there is only Rev A.

“Part Number” will display “XXXX” until an official OPN is available. If an OPN is available, this field will display the full OPN.

Green check indicates board is connected.

Hit magnifying glass to see a list of all OPNs generated by the user’s FPB.

Option 1: Vdd, low power/low jitter, tr/ta

Create report only generates the report and does not program any sample. This is available with or without an FPB board.

Program the target device, generate an OPN and report. User must have a SiLabs.com user ID and be connected to the internet. User DOES NOT have to be connected to program the part and report, but an OPN will not be generated.

Provides the OPN and report. Does not program a part. User must have a SiLabs.com user ID and be connected to the internet.

Clears form.

Figure 1. Main Screen (1 of 2)

Si50x-FPB1-CUST

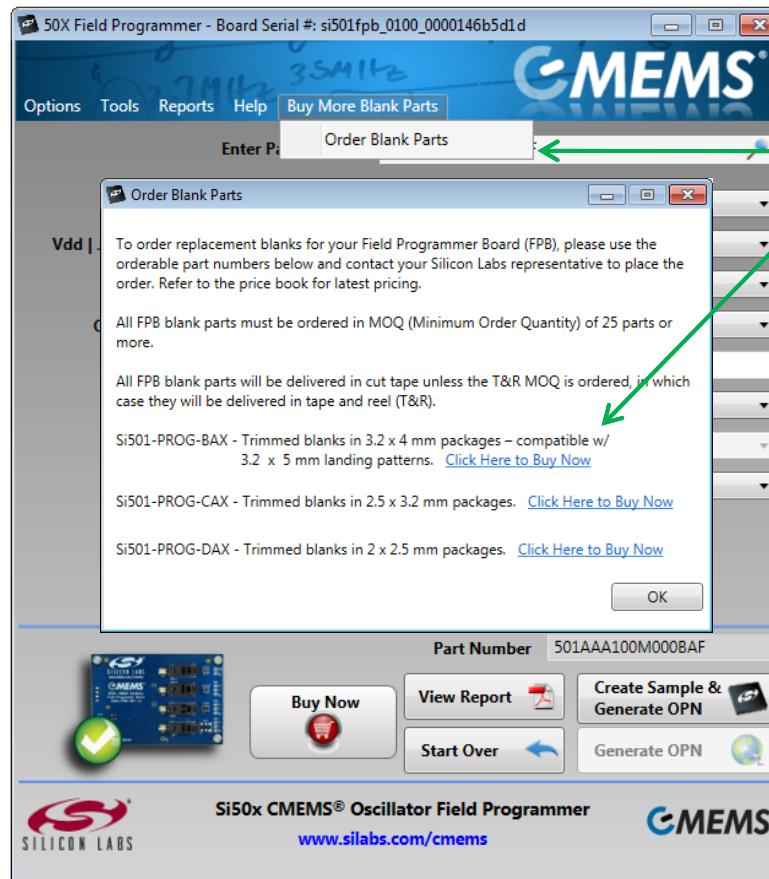

Select "Buy More Blank Parts" to buy more blanks to create more samples.

Click the link to buy the as many blanks as needed in the desired package.

Figure 2. Buy More Blank Parts Screen

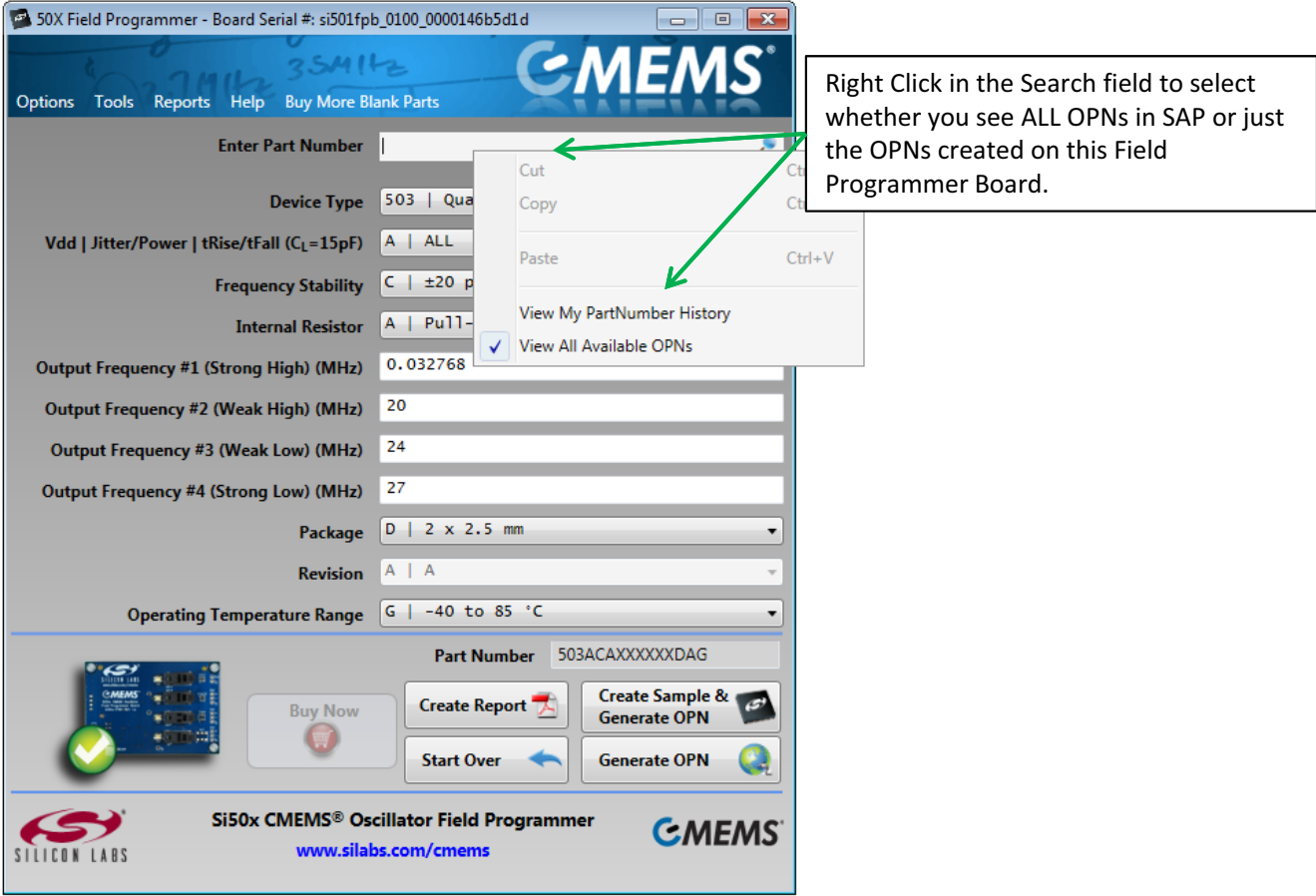

Figure 3. Main Screen (2 of 2)

Table 1. Drop Down Menus

Drop Down Menu	Selection	Function
Options	Exit	Exits GUI.
Tools	Advanced → Control Programmer Board	Allows user to enable/disable VDD and set OE High/OE Low. This is an advanced feature.
	Advanced → Update FW	Updates EVB FW with file saved to hard drive. New FW is included any time the GUI is updated.
	Submit Pending OPNs	If a user has created part configurations while not connected to the internet, they will be stored here. The GUI will also prompt the user to submit pending OPNs at launch.
	Generate OPN	Initiates the process to generate an OPN.
	Query FPB FW Version	Provides FPB MCU Firmware version.
Reports	View Latest Sample Report	Opens last generated report.
	View Part Number History	Opens a table of all part numbers generated by the FPB. The report can be exported to Excel.
	View All Sample Reports on Hard Drive	Opens the directory where all sample reports are stored.
	EVB Firmware Version	Provides the EVB FW version number.
Help	User's Guide	Opens the User's Guide in pdf.
	Device Data Sheet	Opens latest device data sheet. Later revisions of the data sheet are loaded with new GUI SW updates.
	Order Blank Parts	Provides the OPN for more blank parts. More parts must be ordered through Silicon Labs representatives.
	Check for GUI Software Update	Checks www.silabs.com for any available GUI updates.
	Check for FPB Firmware Update	Checks www.silabs.com for any available FW updates for the FPB MCU.
	About	Provides information on FPB SW and FW version numbers.
Buy More Blank Parts	Order more blank parts	Order more blanks samples in whatever package size is required.

Si50x-FPB1-CUST

3. Board Views

3.1. Top Board View

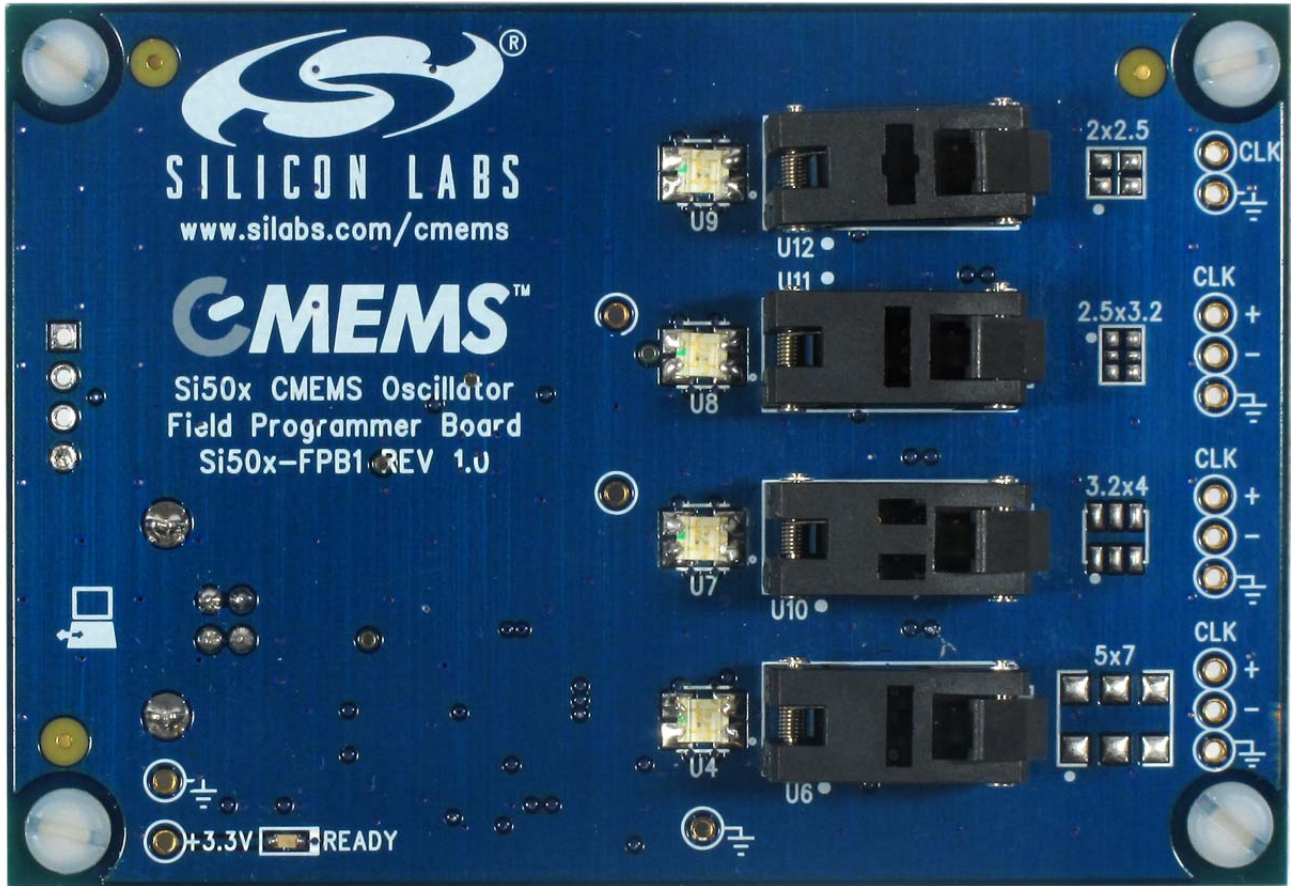

Figure 5. Top Board View

3.2. Bottom Board View

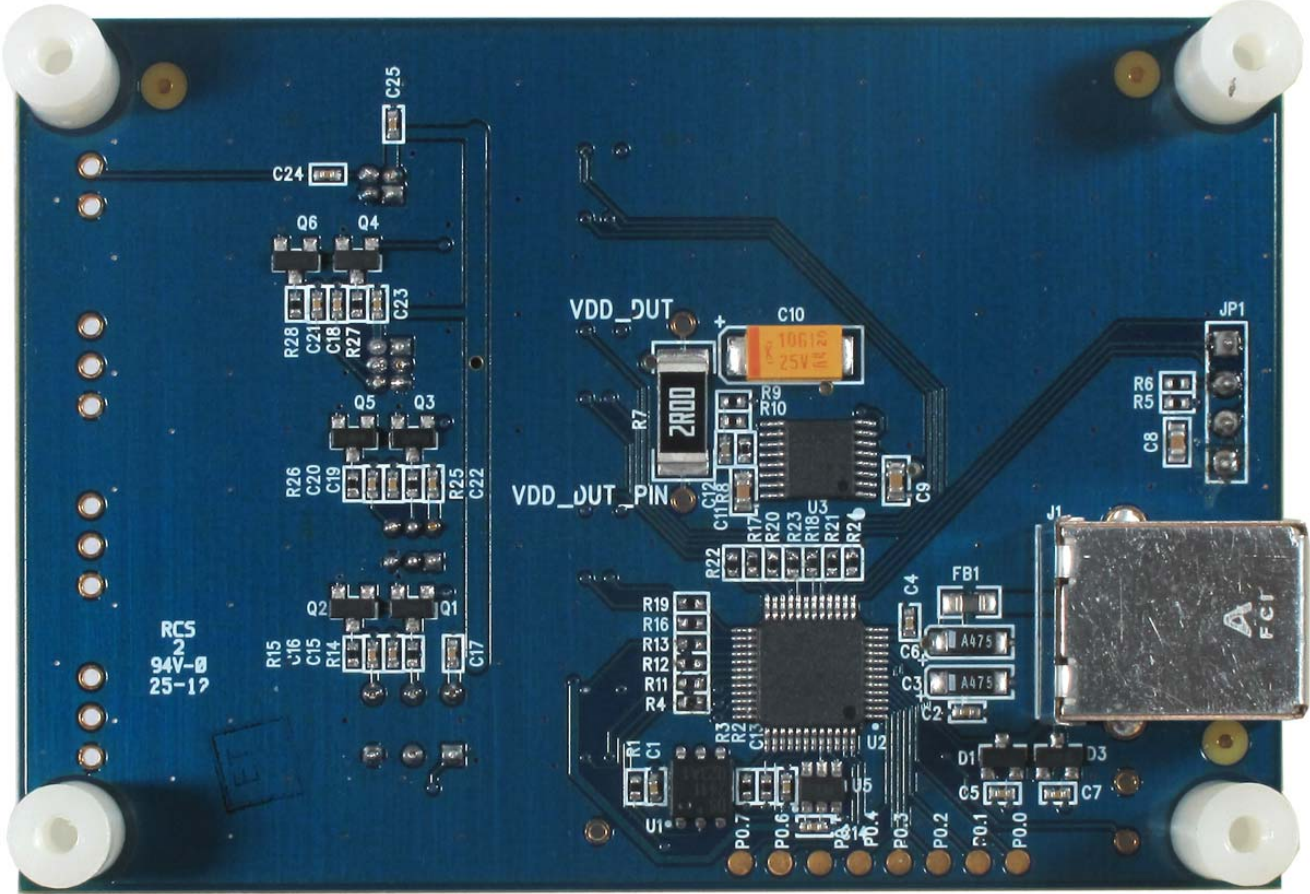

Figure 6. Bottom Board View

4. Functional Description

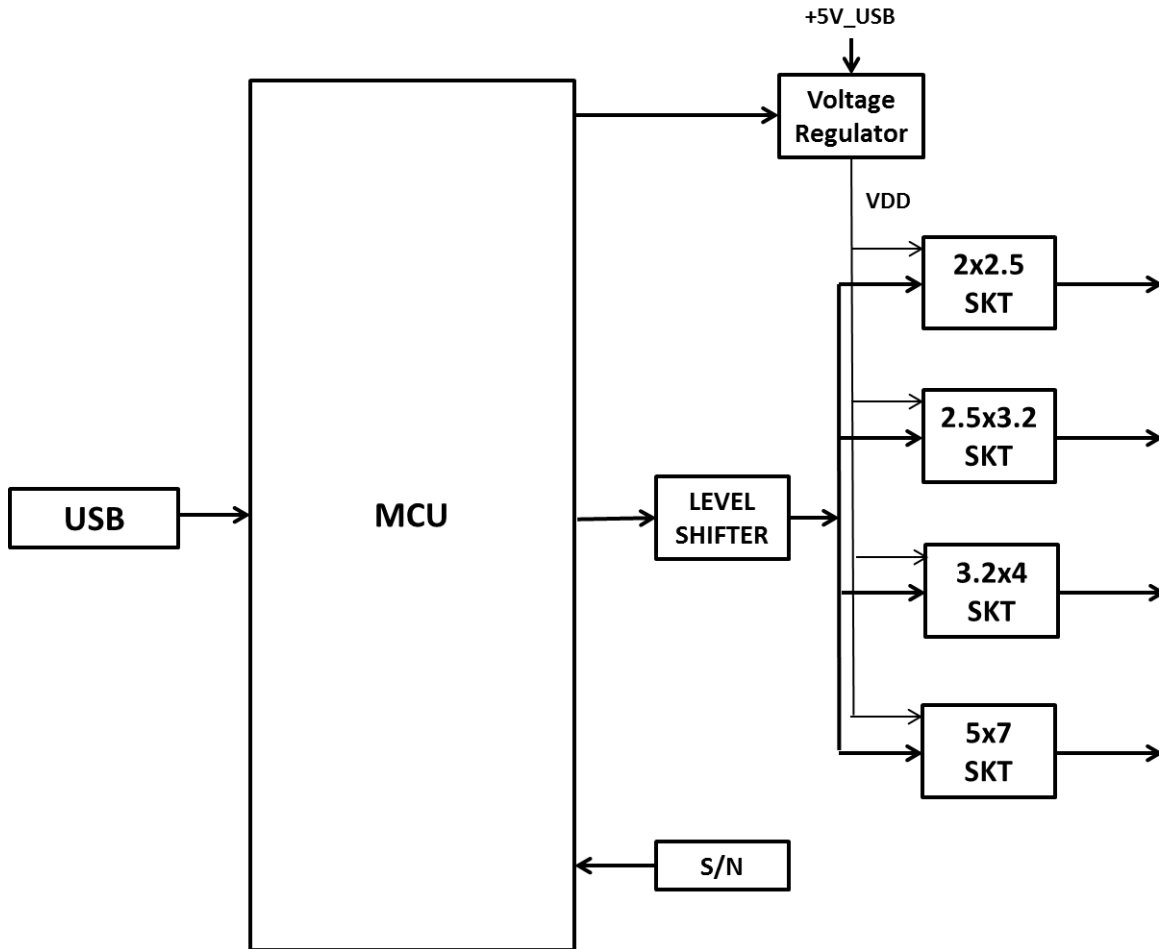

Figure 7. Block Diagram

The pages that follow provide the detailed functional description of the hardware. The FPB schematics, bill of materials, and PCB layouts are included as sections 15, 16, and 17, respectively. Figure 7 provides a block diagram for the board.

Location descriptions in this document assume the reader is viewing the board in the conventional orientation, i.e., looking down on the top side (primary side) with the silkscreen text right side up as in Figure 5.

4.1. Power Supply

The Si50x-FPB1 is pre-configured to accept +5 V from the USB connector at J1. The +5 V is filtered and routed to the MCU, the DUT VDD voltage regulator, and to each DUT's status LEDs. The output of the voltage regulator is under MCU control and yields either 3.3 V or 4.1 V. The higher voltage is used when writing to the DUT's NVM. The power supply components are mounted on the back side of the board

4.2. MCU

The Silicon Laboratories MCU, P/N C8051F380 is also mounted on the back side of the board at U 2. The MCU provides the following functions:

- Supports single-wire communication (C1) to the DUT on behalf of the host PC per the Field Programmable Oscillator Software
- Drives 3-state status indicator LEDs (see Table 3)
- Supplies 3.3 V to peripheral ICs (the serial number generator and the C1 voltage level shifter)
- Controls DUT voltage supply regulator (see Section “4.1. Power Supply”)
- Switches in pull-down near end bias resistors (reserved for future use)
- Auto-detects the board type. The firmware identifies the board type MCU via port P1.7 (pin 29). The voltage at this pin is pulled up internally on the Si50x-FPB1. (The pin is pulled down via an external resistor on the Si501/2/3/4-EVB customer evaluation board.)

Si50x-FPB1-CUST

5. Device Support

The FPB has four latch-able sockets installed to support four different surface mount package sizes. These are enclosed in red in Figure 8 below. To the right of each socket is the corresponding device footprint to further guide the user as to which socket supports which size package. Note that the pin 1 location is marked in silk screen beside each package footprint. The device must be inserted into the socket in this orientation to work. Also note that some landing patterns have six pads. This is to support future differential output devices. The Si501/2/3/4 have four pins and only support single-ended LVCMOS outputs.

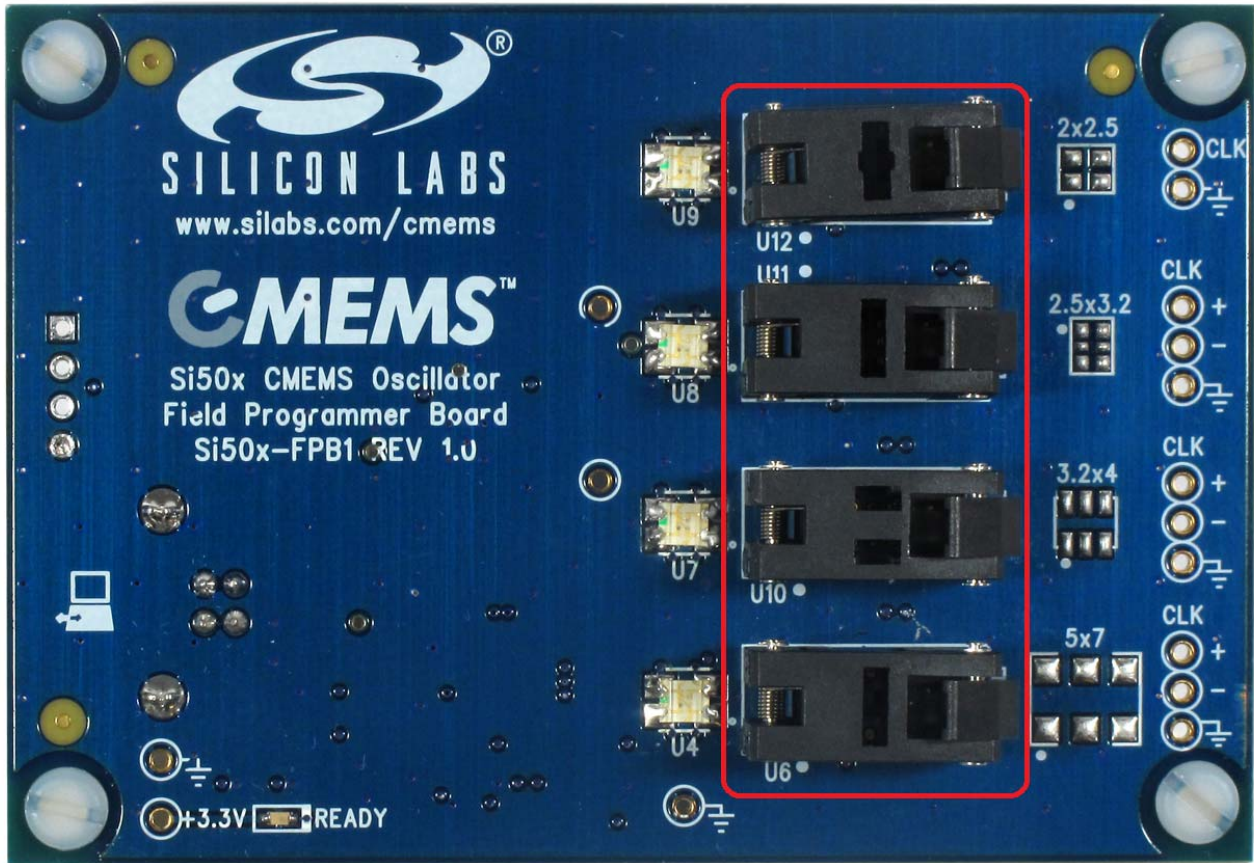

Figure 8. Socket Locations

Reference information regarding sockets and package compatibility is listed in Table 2 below. Sockets are listed in the same relative order as shown in Figure 8.

Table 2. Si50x-FPB1 Device Support

Nominal Package Size (mm)	Socket Ref Des	# Pins	Supported Devices	Notes
2x2.5	U12	4	Si501, Si502 Si503, Si504	
2.5x3.2	U11	6		
3.2x4	U10			
5x7	U6		N/A	Reserved

6. USB

A 4-pin USB Type B receptacle is provided at location J1. The Si50x-FB1 is compatible with USB Specification 2.0. This connector is mounted on the back of the PC board in the lower left hand corner. The location is noted on the top side with silkscreen artwork showing an icon of a PC with bidirectional arrows. See Figure 9 below.

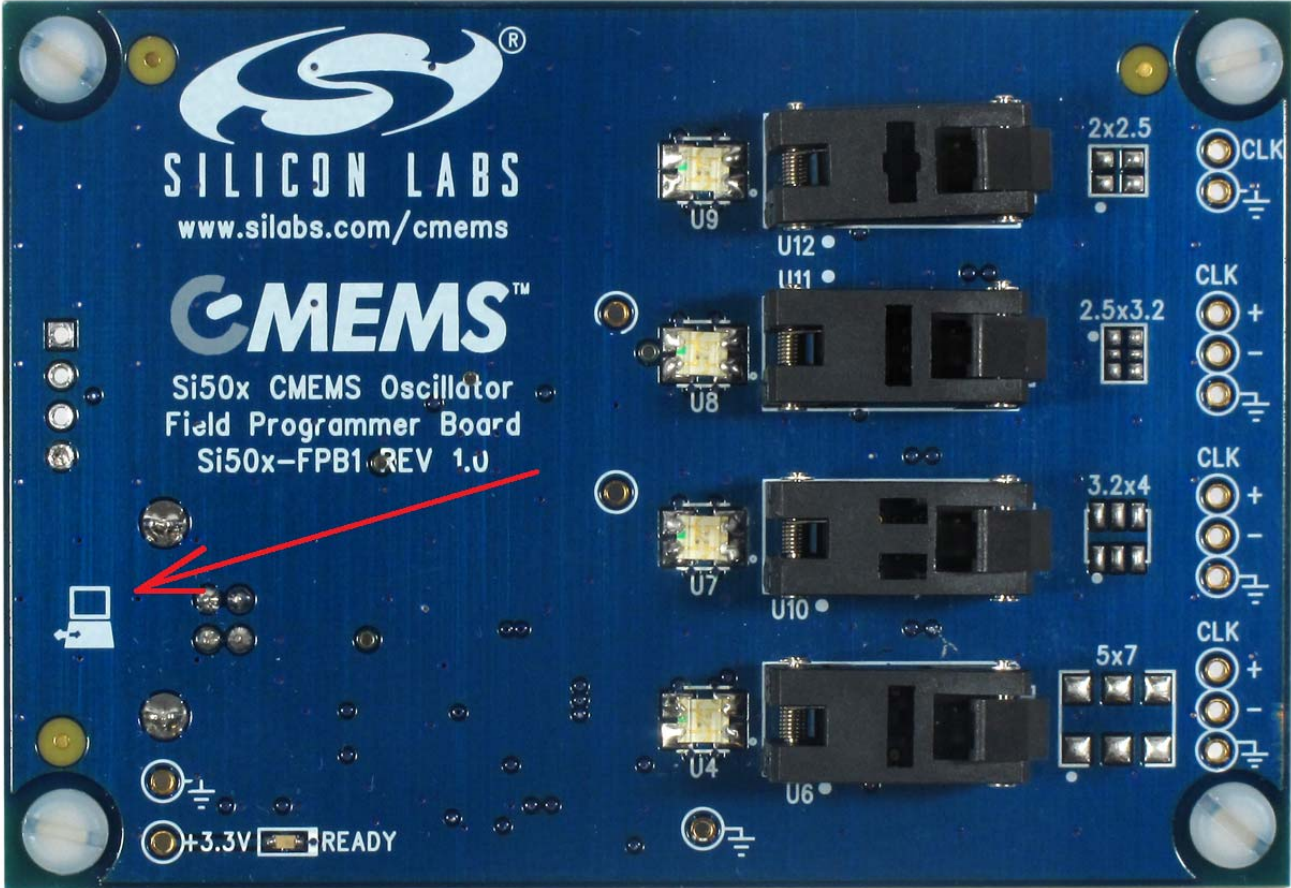

Figure 9. USB Connection Location

Si50x-FPB1-CUST

7. Status Signals

The five LEDs on the board are listed in Table 3. Four of these are surface mount tri-color Red, Green, Blue (RGB) LED units that report the programming status for DUTs in their respective sockets. (Note that yellow or amber is produced by mixing Red + Green light simultaneously). The location of these LEDs is noted in Figure 10.

Table 3. Si501-FPB1 LEDs

Ref Des	Signal	Color (Status)	Notes
D2	Ready	Green	Should illuminate on USB connection (power up)
U4	5x7 Status	Green (Pass) Red (Fail) Yellow (Busy) Blue (Socket Location)	Reserved
U7	3.2x4 Status		
U8	2.5x3.2 Status		
U9	2x2.5 Status		

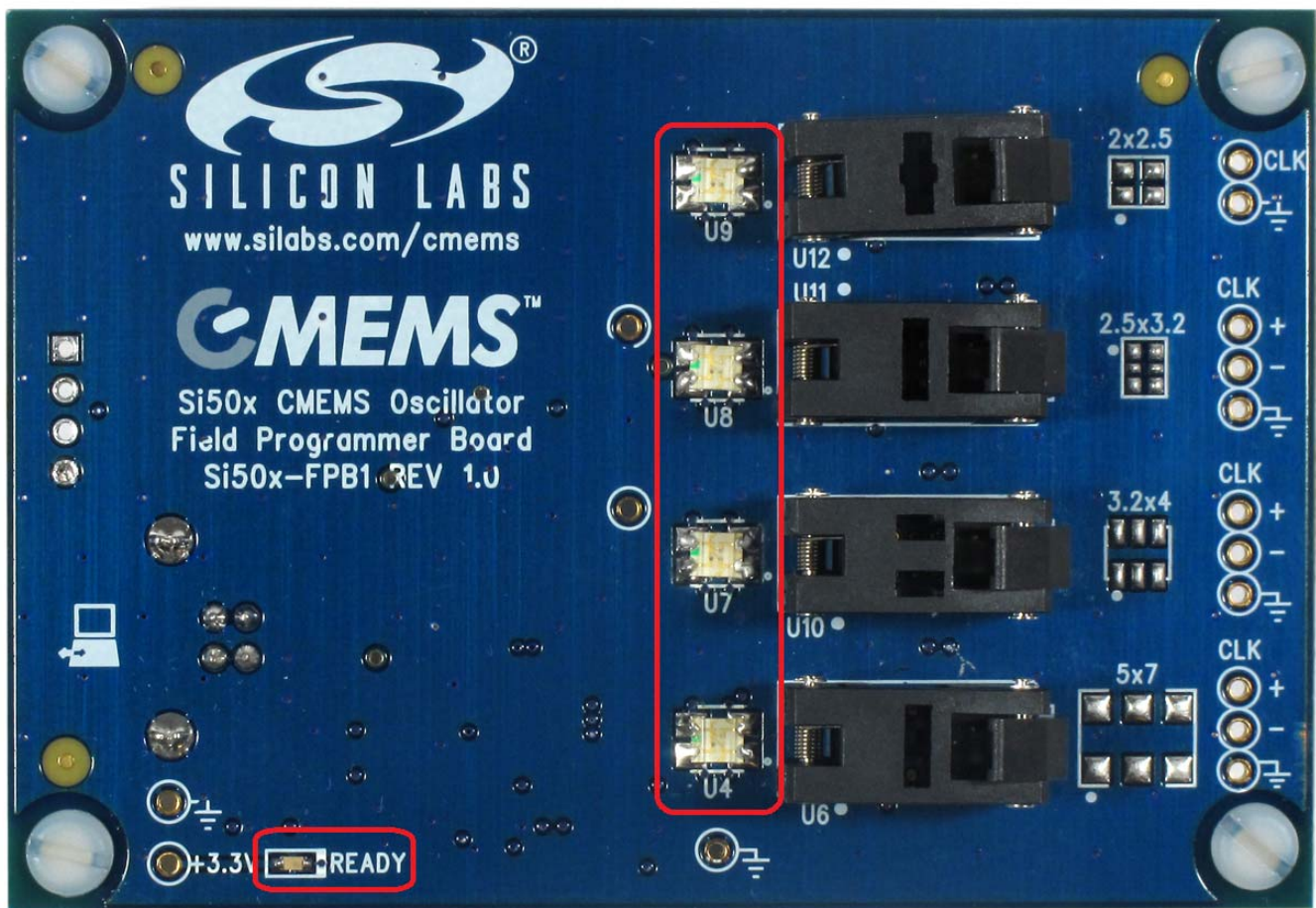

Figure 10. Si501-FPB1 LEDs

8. Current Sense Resistor

There is one current sense resistor located on the FPB designated R7 and placed between test points VDD_DUT_PIN TP15 and VDD_DUT TP16 in the center back side of the board. R7 is pointed out in the photo below. The default or pre-loaded resistor value is 2 Ω. The voltage drop across this resistor may be used for calculating a DUT's current draw and power consumption.

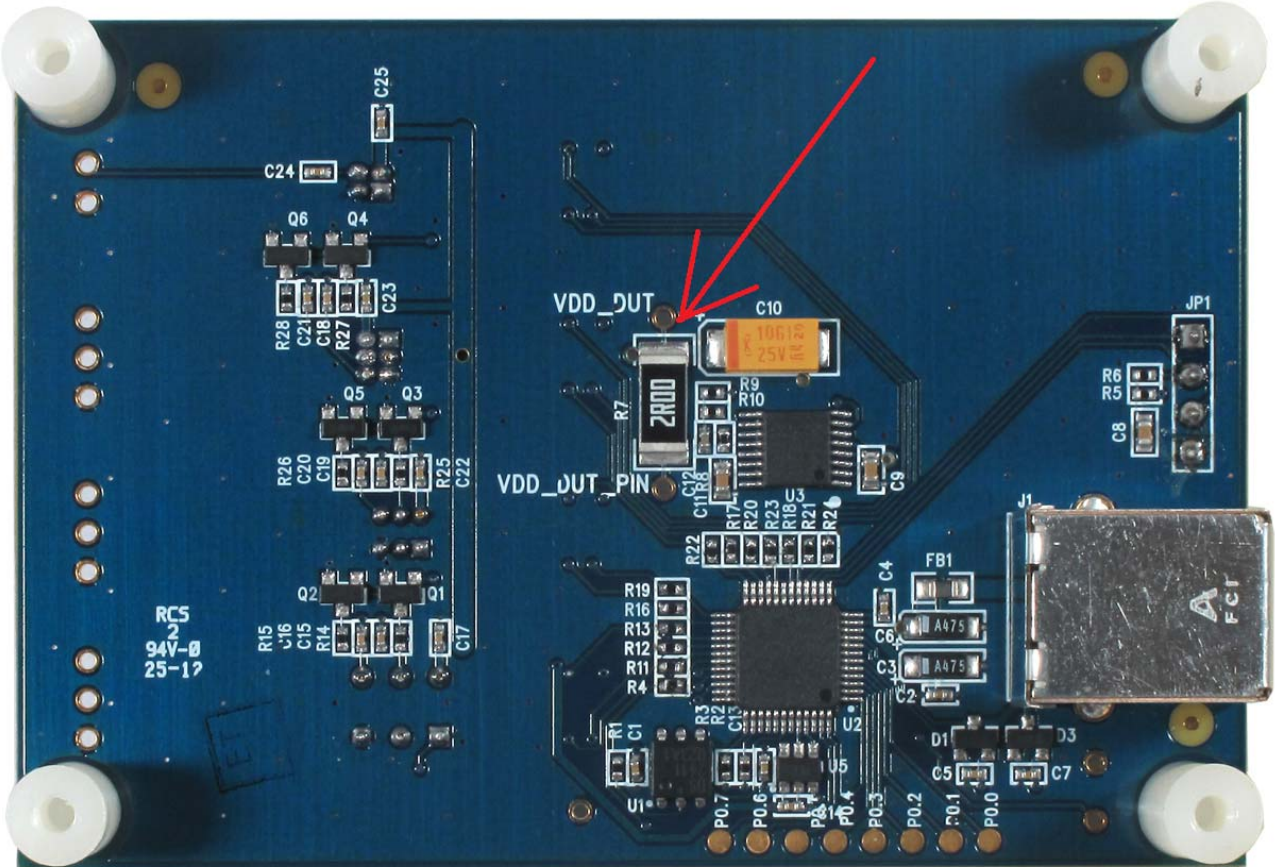

Figure 11. Current Sense Resistor Location

Si50x-FPB1-CUST

9. Outputs

At this time, the Si50x-FPB1 supports only single-ended format outputs on the Si501/2/3/4 CMEMS oscillator. The three 6-pin sockets will support differential outputs on future oscillator devices. Near-end bias resistors are installed to support future devices. All outputs are ac-coupled to test points on the right hand side edge of the board (see Figure 12). These output test points are also included in Table 4.

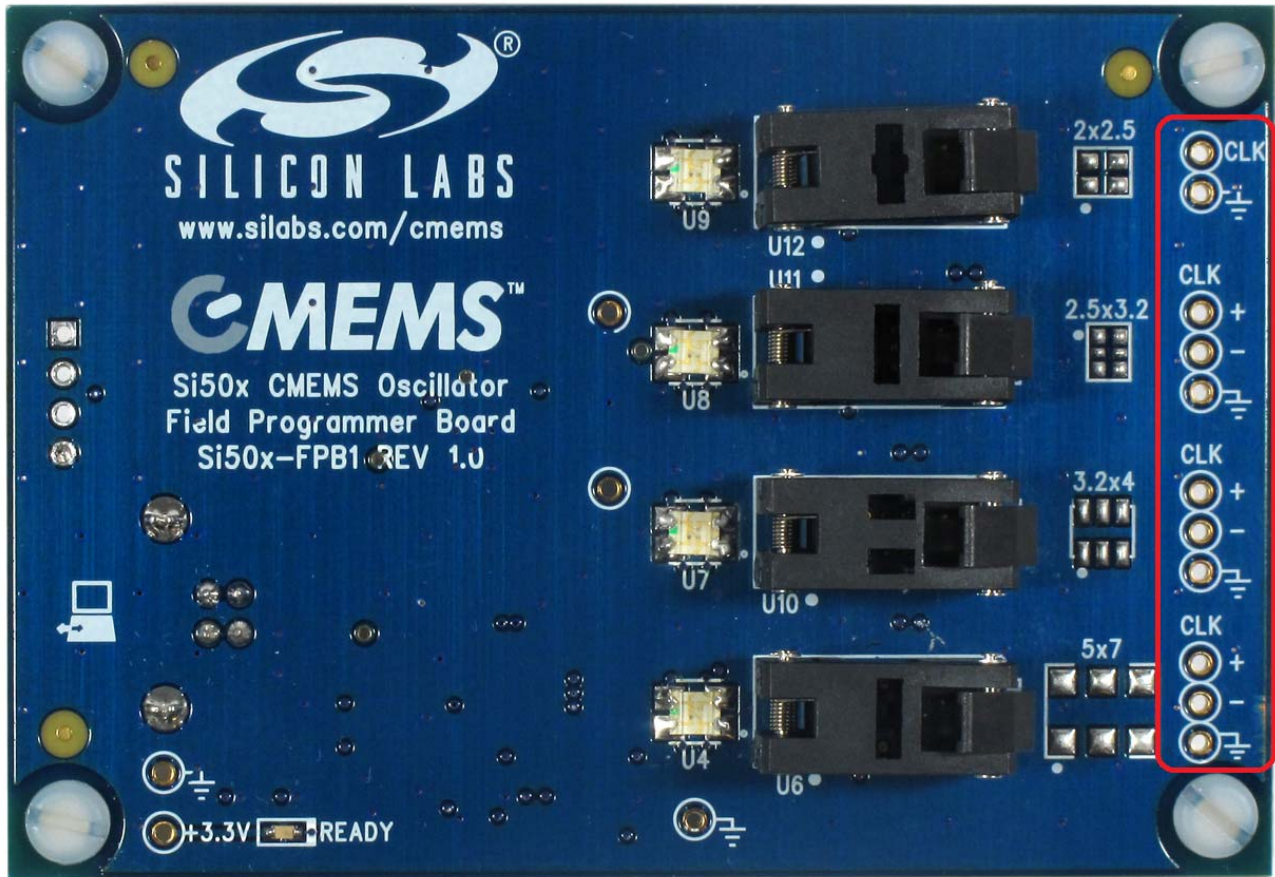

Figure 12. Output Test Points

10. Headers and Test Points

For reference purposes, all headers (JP*) and test points (TP*) are collected in Table 4. There are no headers intended for routine jumper use in the current version of the FPB. The output test points give ac-coupled access to a DUT installed in a socket. Generally, these test points are not populated. (The “NI” in the Notes column means “Not Installed”.)

Table 4. Si50x-FPB1 Headers and Testpoints

Category	Ref Des	Signal	Notes
MCU	JP1	1-C2D	Header 4x1
		2-C2CLK	
		3-BOOTLDR	
		4-GND	
Power Supplies	TP1	3.3V	Red Loop
	TP11	GND	Black Loop
	TP12	GND	Black Loop
	TP15	VDD_DUT_PIN	Red Loop
	TP16	VDD_DUT	Red Loop
Outputs	TP17	5x7 CLKN	NI
	TP18	5x7 CLKP	NI
	TP19	5x7 GND	NI
	TP20	3.2x4 CLK_N	NI
	TP21	2.5x3.2 CLKN	NI
	TP22	3.2x4 CLKP	NI
	TP23	2.5x3.2 CLKP	NI
	TP24	2x2.5 CLK	NI
	TP25	3.2x4 GND	NI
	TP26	2.5x3.2 GND	NI
	TP27	2x2.5 GND	NI

Si50x-FPB1-CUST

11. Software Guide

Users must download the Si50x CMEMS Oscillator Software, available from the Silicon Labs website at www.silabs.com/Si50x-FPB1. This software includes a User's Guide as well. The FPB SW controls the FPB and allows the user to set all configurable parameters, program devices, and generate orderable part numbers and reports.

11.1. Configuring the Si501-FPB1

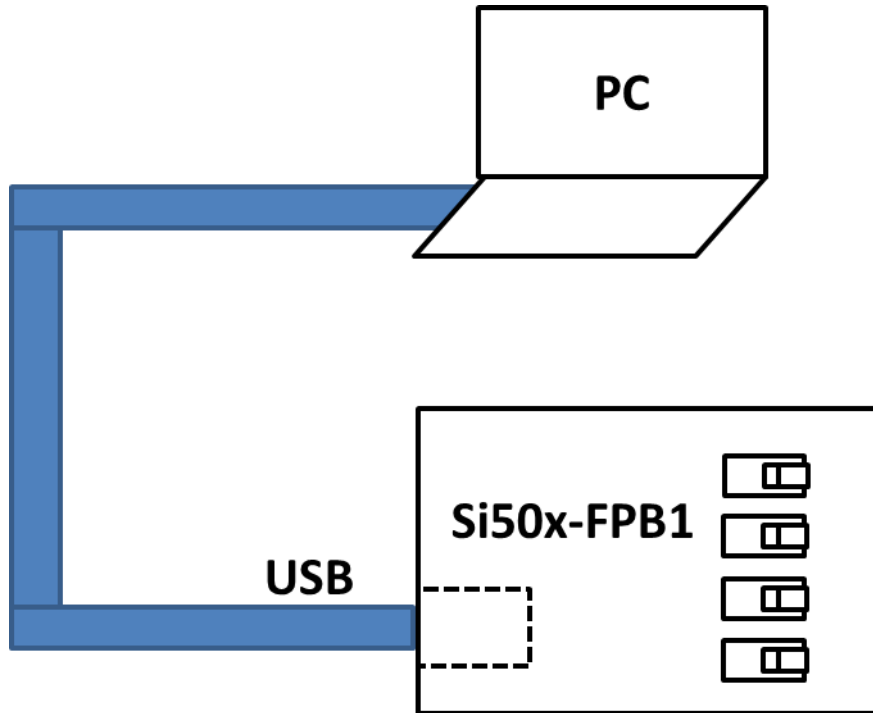

Figure 13. Si50x-FPB1 Typical Configuration

11.2. 50X Field Programmer Software Installation

The following sections describe how to install and use the 50X Field Programmer software. This software runs on a USB equipped PC to field program the NVM of Si501/2/3/4 MEMS oscillators. It can also be used to generate an OPN (Orderable Part Number). Context sensitive help windows pop up when the cursor hovers above a feature on the GUI.

There is a readme.txt file with the installation files as well as a software user guide installed with the software.

System Requirements

- Microsoft Windows® 2000, XP, Vista, 7
- USB 2.0
- 2 MB of free hard drive space
- 1024 x 768 screen resolution or greater
- Microsoft .NET Framework 4.0
- USBXpress 3.1.1 driver

Note: USBXpress 3.1.1 driver is provided and installed with the software.

11.3. Microsoft .NET Framework Installation

The Microsoft .NET Framework is required before installing and running the software. Details and installation information about the .NET Framework are available via a shortcut in the NETFramework directory or at the following web site:

<http://www.microsoft.com/en-us/download/details.aspx?id=26>

There are multiple versions of the .NET Framework available from Microsoft, and they can be installed side-by-side on the same computer. The software requires Version 4.0. Contact your system administrator for more details.

11.4. Si50x CMEMS® Field Programmer Oscillator Software Installation

The Si50x CMEMS Oscillator Software is installed from the Si50xCMEMSSwInstall.exe file.

1. Double-click the install file to start the wizard.
2. Follow the wizard instructions to complete the installation for both the software and the driver. Use the default installation location for best results.
3. After the installation is complete, click on Start → Programs → Silicon Laboratories → Si50x CMEMS Oscillator Software. Select one of the items in the menu including the User Guide to get more details on how to run the software.

Si50x-FPB1-CUST

12. Si50x CMEMS® Field Programmer Oscillator Software Overview

The FPB software supports specifying a configuration and then creating a sample or generating an Orderable Part Number or OPN. The main menus appear at the top as shown in the red rounded rectangle in the GUI excerpt below.

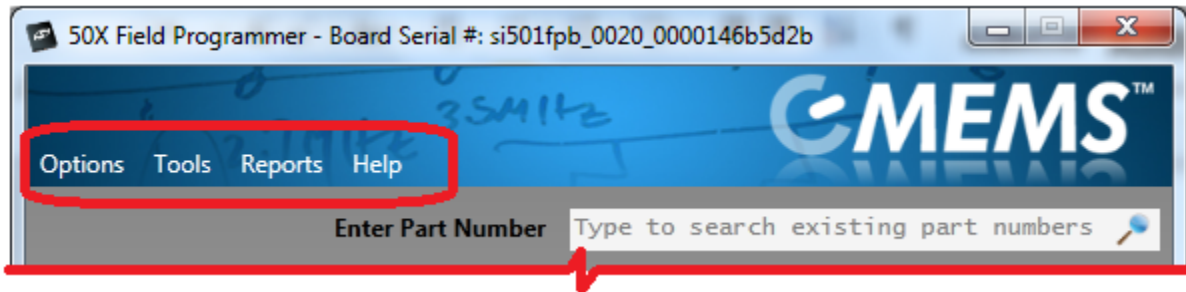

The top level menus and their pull-down functions are listed in Table 1, “Drop Down Menus,” on page 7.

13. Basic Operating Instructions

Basic operating instructions are illustrated in the following section based on a step by step example session.

1. Connect the Field Programmer Board by USB

Once the GUI software is installed, the Field Programmer Board must be connected to any available USB port on the PC hosting the GUI software.

If the USB connection is broken or not functional, a red indicator on the GUI will be displayed. The top banner of the window will also indicate “no programmer found”.

If this error occurs unexpectedly, verify that your USB port is operational and/or the GUI software and USB driver is properly installed.

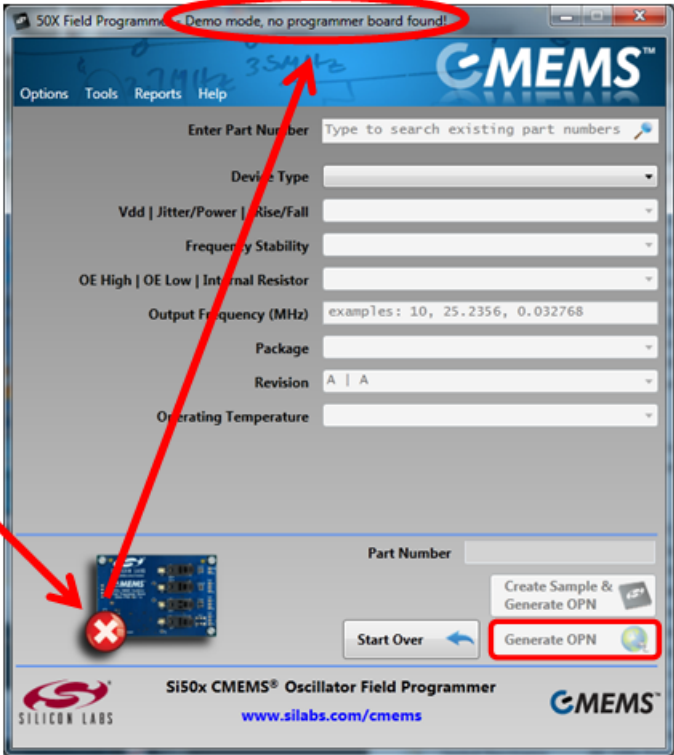
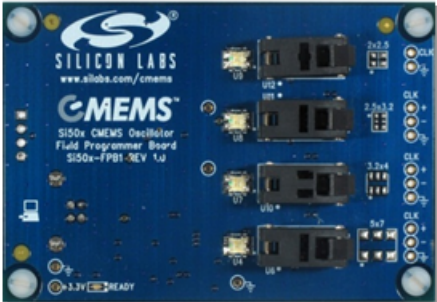

Si50x-FPB1-CUST

When the USB connection is operating, the indicator turns green and a green “Ready” LED will illuminate on the Field Programmer Board. We can now move on to selecting the target device and options.

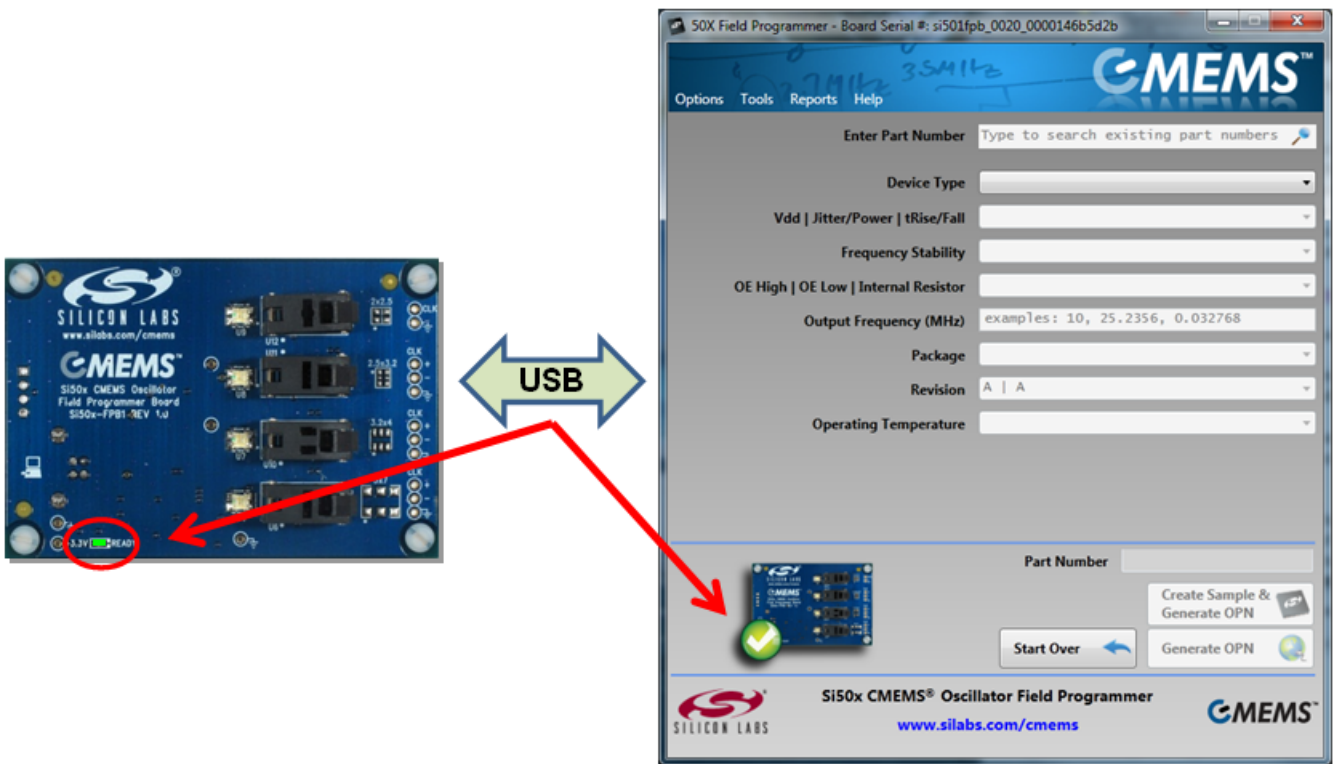

2. Select Device Type

It is recommended that option parameters are selected starting from the top with “Device Type” and proceeding sequentially downward. Pull down selections are available for most options. In this example, we select the Si503 as our target device. The Si503 allows for the selection of four programmed frequencies controlled by external pull-up and pull-down resistors at the FS/OE pin.

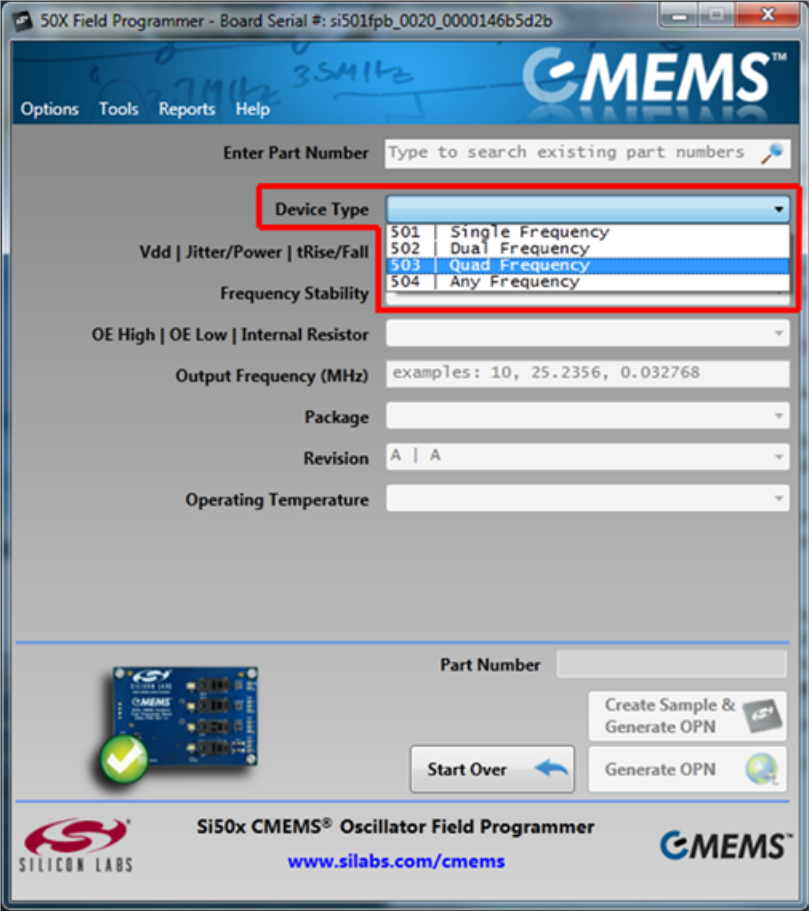

Si50x-FPB1-CUST

3. Select VDD, Jitter/Power, and Rise/Fall Time Options

VDD, Jitter, Power Mode, and Rise/Fall Time (tRise/Fall) options are shown in the pull down menu. The Si501 family supports a low period jitter option that consumes slightly more power (about 1 to 2 mA) or a low-power option that results in slightly more period jitter (about 1 to 1/2 ps rms). Selecting the right tRise/Fall is a key benefit of the Si501 family as you can easily drop-in to competitive sockets by matching their existing drive strength.

For this example, Lower Jitter with 0.7 ns rise/fall time options are selected, which is option “H”.

50X Field Programmer - Board Serial #: si501fpb_0020_0000146b5d2b

Options Tools Reports Help

Enter Part Number Type to search existing part numbers

Device Type 503 | Quad Frequency

Vdd | Jitter/Power | tRise/Fall

A	ALL	Lower Power	0.7ns
B	3.3V	Lower Power	1.3ns
C	2.5V	Lower Power	1.3ns
D	1.8V	Lower Power	1.3ns
E	ALL	Lower Power	2.5ns
F	ALL	Lower Power	5ns
G	ALL	Lower Power	10ns
H	ALL	Lower Jitter	0.7ns
J	3.3V	Lower Jitter	1.3ns
K	2.5V	Lower Jitter	1.3ns
L	1.8V	Lower Jitter	1.3ns
M	ALL	Lower Jitter	2.5ns
N	ALL	Lower Jitter	5ns
P	ALL	Lower Jitter	10ns

Frequency Stability

Internal Resistor

Output Frequency #1 (MHz)

Output Frequency #2 (MHz)

Output Frequency #3 (MHz)

Output Frequency #4 (MHz)

Package

Revision A | A

Operating Temperature

Part Number 503XXXXXXXXXAX

Create Sample & Generate OPN

Start Over

Generate OPN

Si50x CMEMS® Oscillator Field Programmer

www.silabs.com/cmems

SILICON LABS

CMEMS™

Lowest jitter selected

4. Select Frequency Stability

The Si501 frequency stability is guaranteed for 10 years of operating life. In this example, a frequency stability of ± 20 ppm is selected.

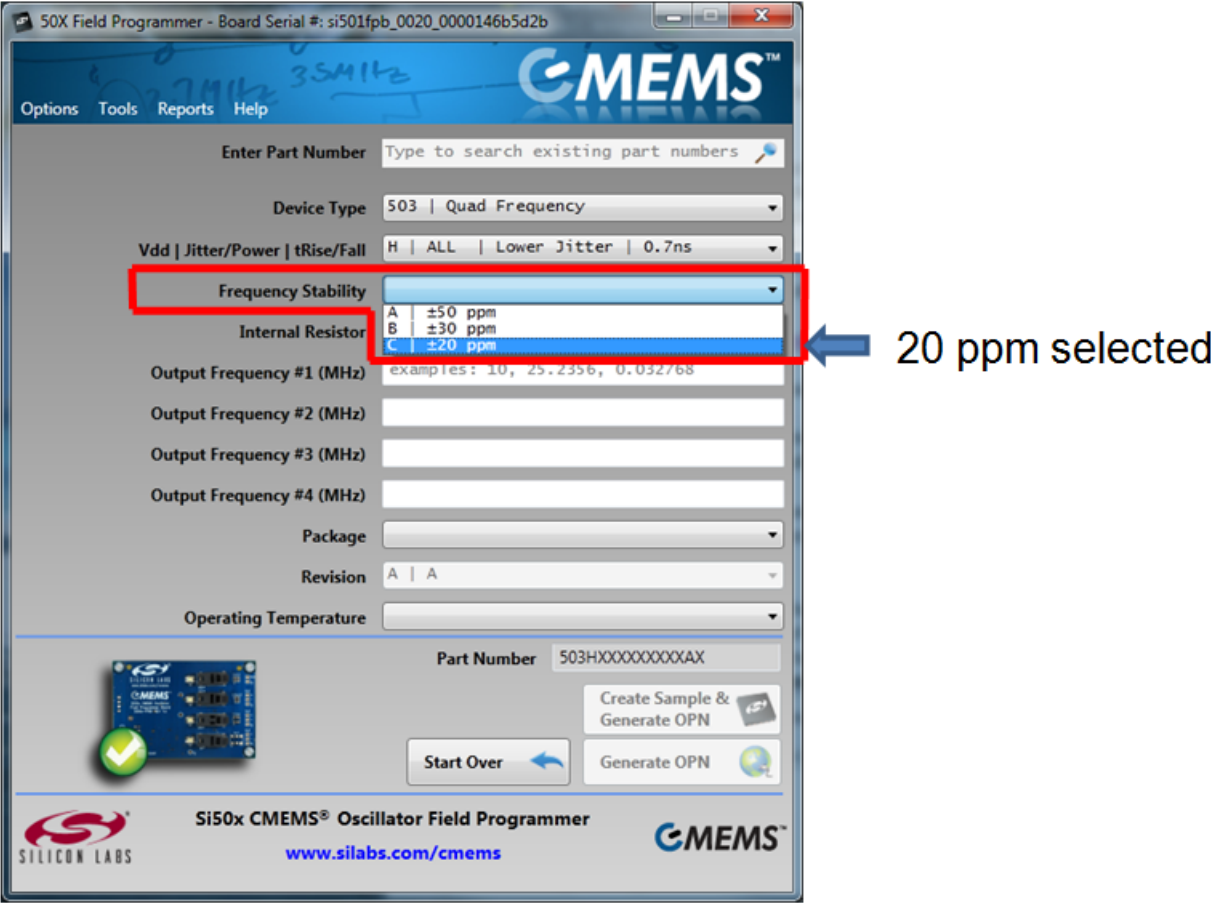

Si50x-FPB1-CUST

5. Select Internal Resistor

Device default functionality is set to Run, Sleep, Doze, etc., according to a configurable OE selection.

The internal OE pull-up is selected for this example. Refer to the device data sheet for more details on the use and external termination options of the multi-function OE pin.

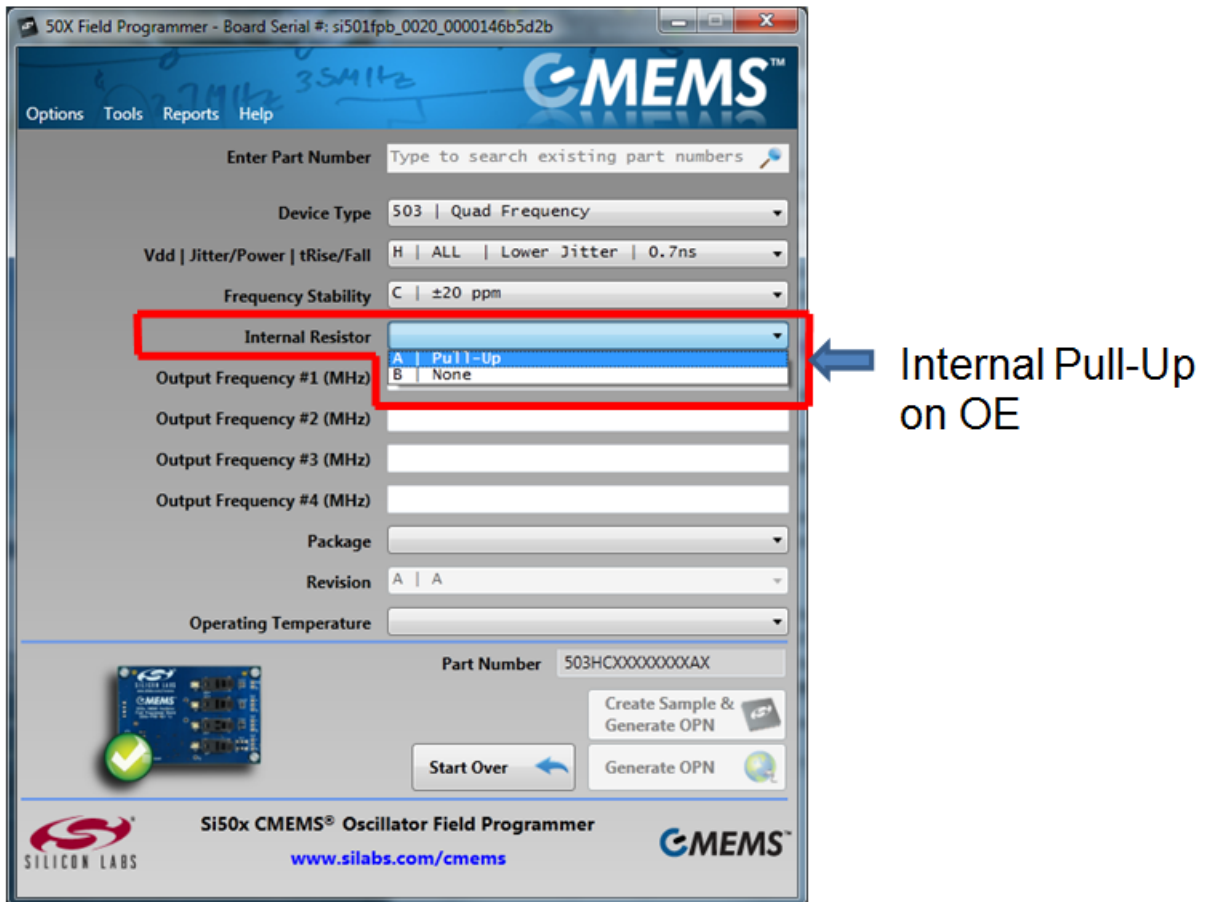

Note that the appearance of the GUI will change based upon the device selection. Had we selected a comparable version Si502 (the dual frequency counterpart), the window would appear as follows.

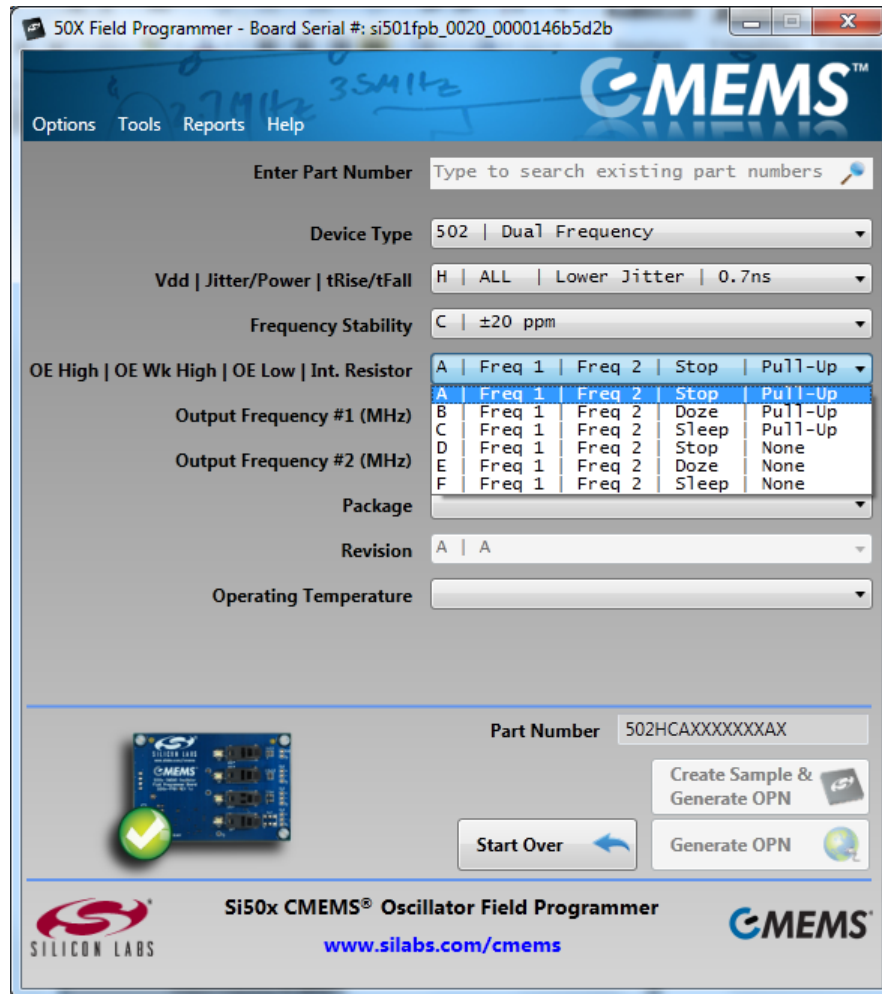

In this case, the **Internal Resistor** selection has been replaced by the **OE High | OE Wk High | OE Low | Int. Resistor** selection. As the data sheet explains, if the pull-up resistor is $< 2\text{ k}\Omega$, it is a strong pull-up resistor resulting in a “Strong High” and abbreviated in the GUI simply as OE High. If the pull-up resistor is $> 16\text{ k}\Omega$, it is a weak pull-up resistor, resulting in a “Weak High” at the OE pin.

The OE Internal Pull-up resistor is nominal $50\text{ k}\Omega$, which is a “Weak High” resistor value. Therefore, the default frequency selection for OE Wk High is Freq 2. In the example above, pulling the OE pin low results in the Stop condition which means the output is disabled and the internal oscillator is set to $F_{CLK} = 1\text{ MHz}$.

Si50x-FPB1-CUST

6. Specify Output Frequencies

Since the Si503 is a four frequency device, each frequency must be specified. Output 1 is assigned a frequency of 32.768 kHz (for a clock timer application), output 2 to 12.288 MHz (for an audio clock application), output 3 to 24 MHz (for a USB application), and output 4 to 250 MHz. For the purposes of illustration, the last assignment is a purposefully introduced typo. The frequency should have been 25 MHz for a MCU application.

Notice output frequency #4 is flagged. It is highlighted in red with a red graphic. If we hover the cursor over the red “x” graphic, we will see an explanation of the problem. The Si503 can support a maximum frequency of 100 MHz. The attempted 250 MHz assignment exceeds the limit and is therefore not supported.

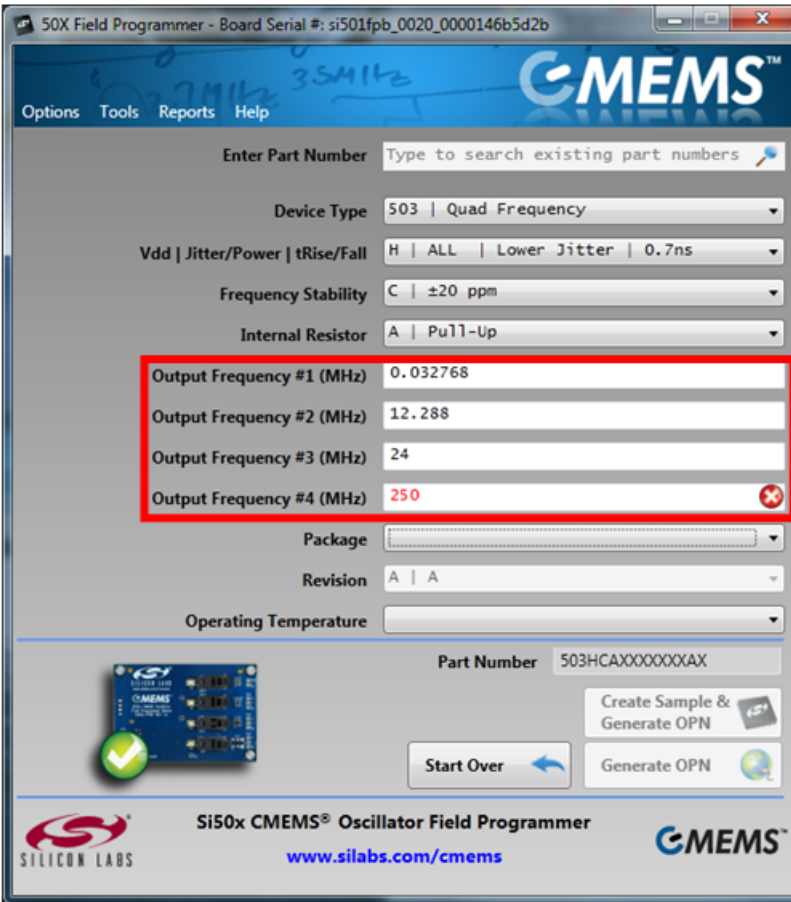

Assign frequencies

- ← 32.768 KHz
- ← 12.288 MHz
- ← 24 MHz
- ← 250 MHz – **Illegal value!**

Note: Frequencies not supported are highlighted in red with warning symbol. GUI will verify legal values for all device settings and parameters before allowing device creation.

Si50x-FPB1-CUST

When valid frequency selections are entered, we can proceed to the next option. At this point, if any option or parameter is not properly specified, the “Create Sample & Generate OPN” button is grayed-out and Sample Creation is not yet possible. We need to make a few more selections before programming can begin.

The screenshot shows the Si50x Field Programmer software interface. The window title is "50X Field Programmer - Board Serial #: si501fpb_0020_0000146b5d2b". The interface includes a menu bar (Options, Tools, Reports, Help) and a main configuration area. The configuration area contains several dropdown menus and input fields:

- Enter Part Number: Type to search existing part numbers
- Device Type: 503 | Quad Frequency
- Vdd | Jitter/Power | tRise/Fall: H | ALL | Lower Jitter | 0.7ns
- Frequency Stability: C | ±20 ppm
- Internal Resistor: A | Pull-Up
- Output Frequency #1 (MHz): 0.032768
- Output Frequency #2 (MHz): 12.288
- Output Frequency #3 (MHz): 24
- Output Frequency #4 (MHz): 25
- Package: [Empty]
- Revision: A | A
- Operating Temperature: [Empty]
- Part Number: 503HCAXXXXXXXAX
- Buttons: Start Over, Create Sample & Generate OPN (grayed out), Generate OPN

Annotations on the right side of the screenshot:

- Assign frequencies** (underlined text)
- Blue arrows pointing to the frequency input fields with labels: 32.768 KHz, 12.288 MHz, 24 MHz, and 25 MHz (*now valid frequency*)
- A blue arrow pointing to the "Create Sample & Generate OPN" button with the label "Not yet active"

Si50x-FPB1-CUST

7. Select Package

For package size, the 2.0 x 2.5 mm package is selected. Once this selection is made, a blue LED will illuminate on the Field Programmer Board next to the 2.0 x 2.5 mm socket. This LED serves to guide the installation of the blank part into the proper socket. Make sure you carefully install a blank part in the appropriate indicated socket and ensure all other sockets are empty.

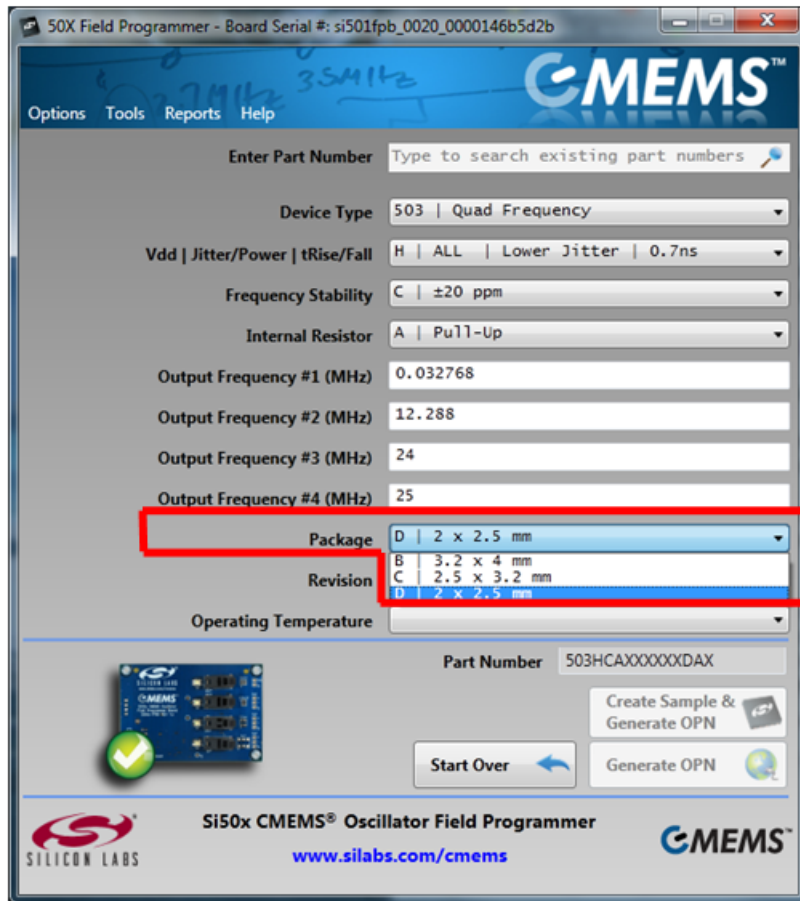

Note: Once package is selected, the corresponding LED is illuminated on programming board to indicate proper socket.

2.0 x 2.5 mm pkg selected

8. Select Operating Temperature

The final selection is the operating temperature range. In this example, the industrial temp range of -40 to +85 °C is selected.

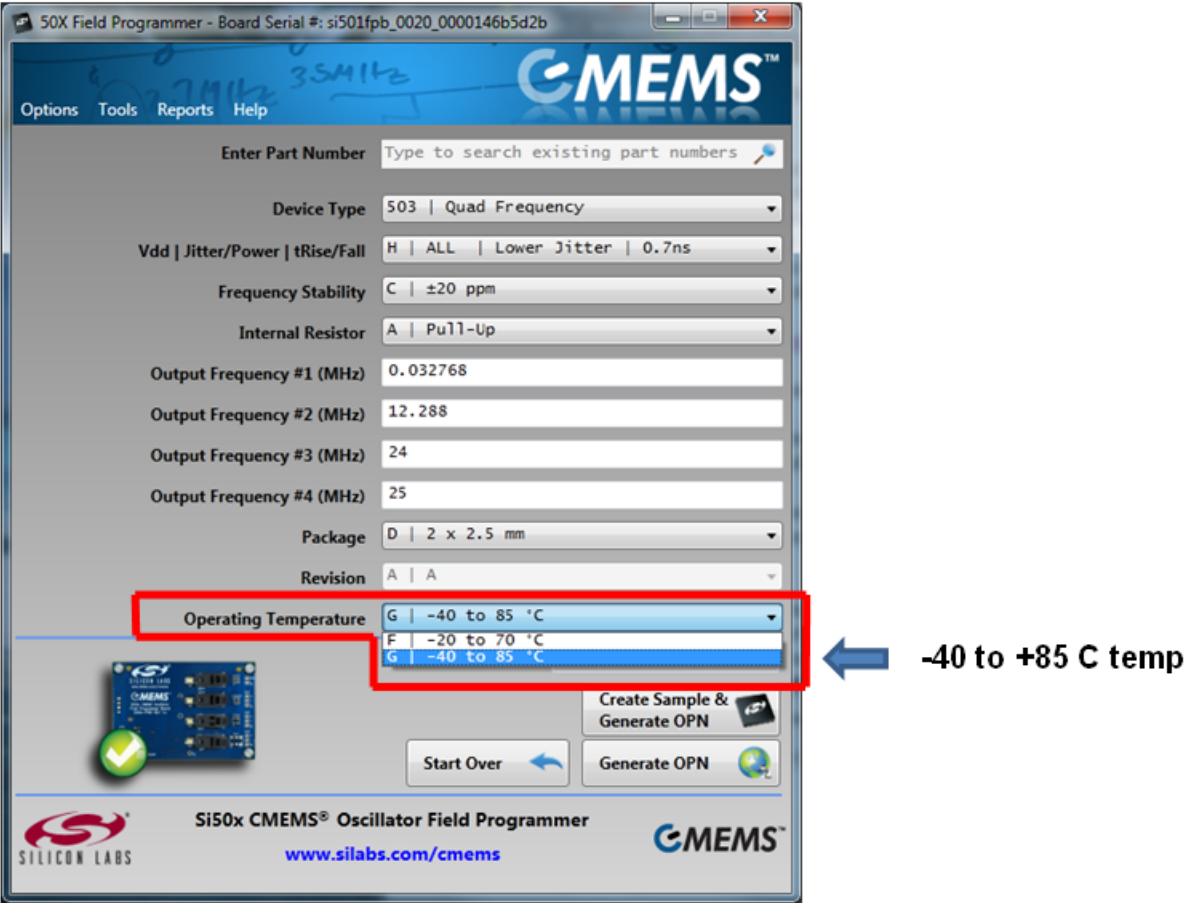

Si50x-FPB1-CUST

9. Create a Sample

Once all options and parameters have been entered and validated, the “Create Sample & Generate OPN” button is now active. Press the “Create Sample & Generate OPN” button to start the programming process.

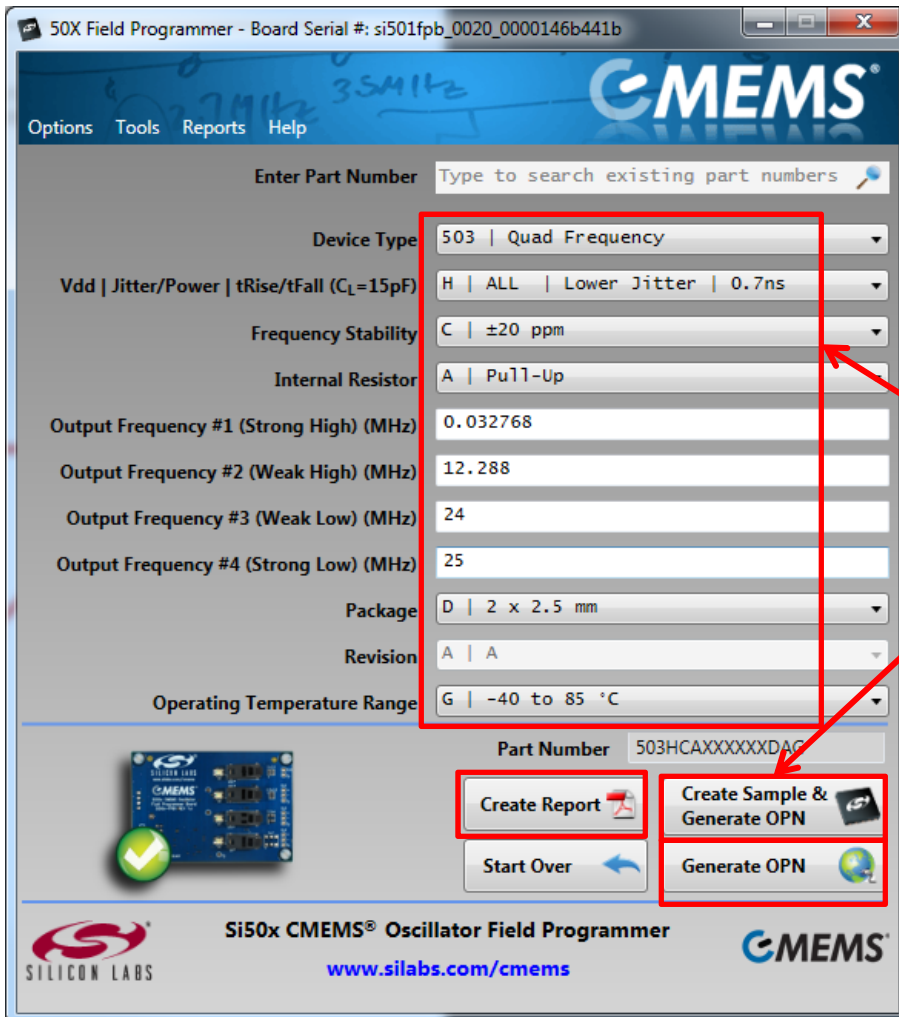

10. Place Blank Part in Socket

At this point, place a blank part into the socket indicated by the blue LED and then press the “Confirm” button to proceed.

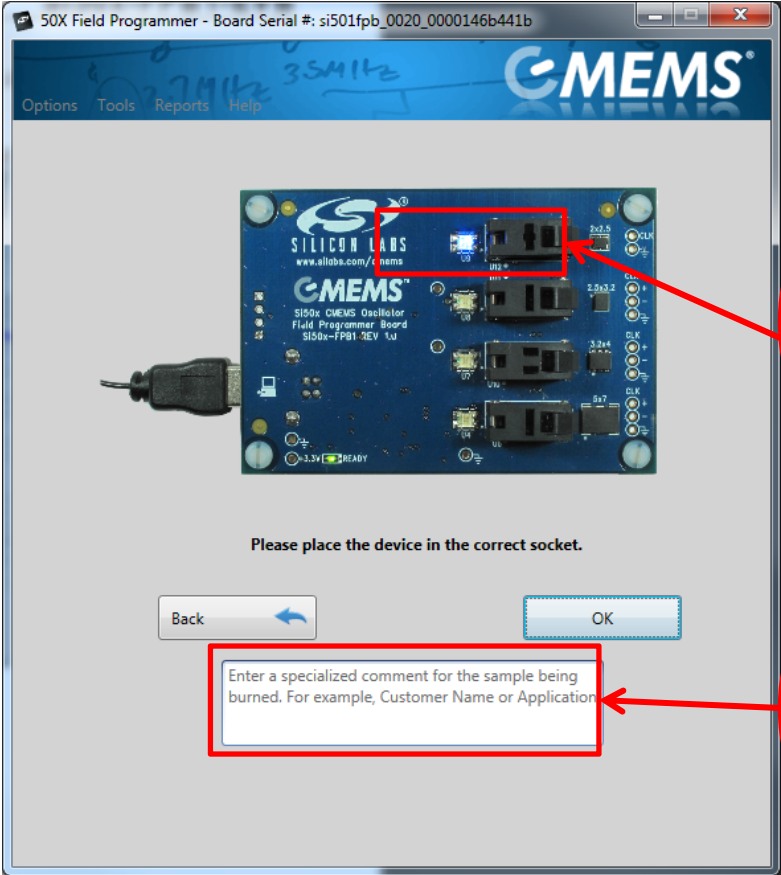

Note: Before programming is started, make sure the socket indicated by the blue LED is properly loaded with a device.

User may enter comments here. They will be printed on the OPN report.

Si50x-FPB1-CUST

The Field Programmer will first check to make sure a blank part is installed in a socket.

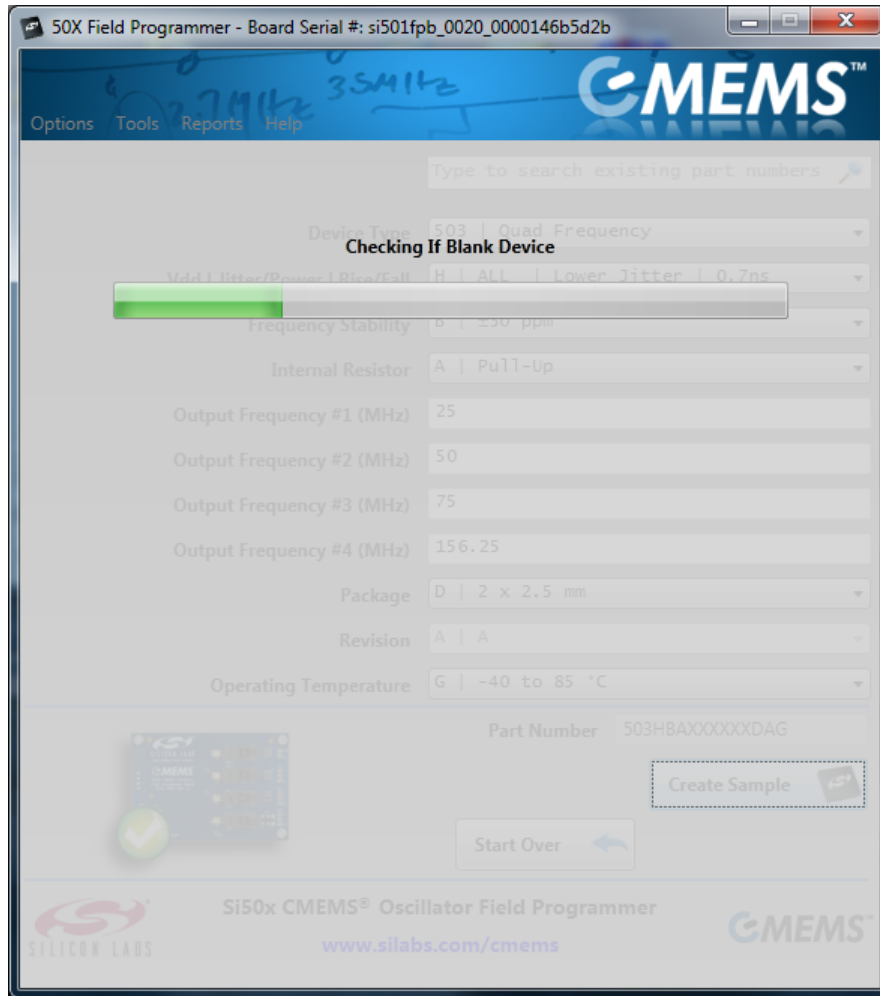

11. Connect to Silicon Labs

Once a blank part has been verified, the Field Programmer GUI software will check for an internet connection to Silicon Labs. If a connection has been made, but the user has not previously logged-in, log-in credentials will be required. For new users, select the “Create Your Profile” button and follow the directions. Once properly logged-in, programming will continue.

If no connection, or log-in is unsuccessful, you can select “Cancel OPN Generation”.

If a previous login connection is still active, this page will be skipped altogether.

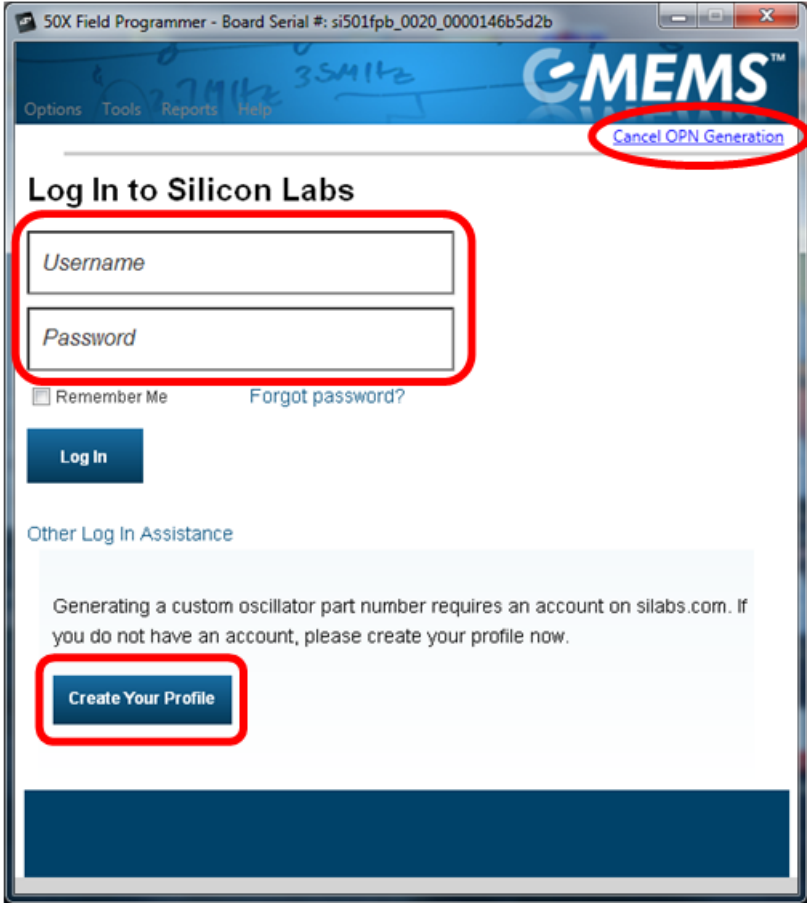

Si50x-FPB1-CUST

12. Checking and Report Generation

Once connection to Silicon Labs has been established, the device will be programmed and a programming report will be created.



13. Programming Complete

The CMEMS oscillator has been successfully programmed. A sample device and an orderable part number has been created.

It is now safe to remove the programmed part from the socket. Note that, once a part is programmed, it cannot be changed or re-programmed. Each CMEMS part stores its configuration in on-chip, One-Time Programmable (or OTP) memory.

Select “View Report” to see a report of the programmed device. The report gives a record of the part and the corresponding OPN.

Select “Create Another” to create another sample with the same part number or select “Back” to return to the main page or start page.

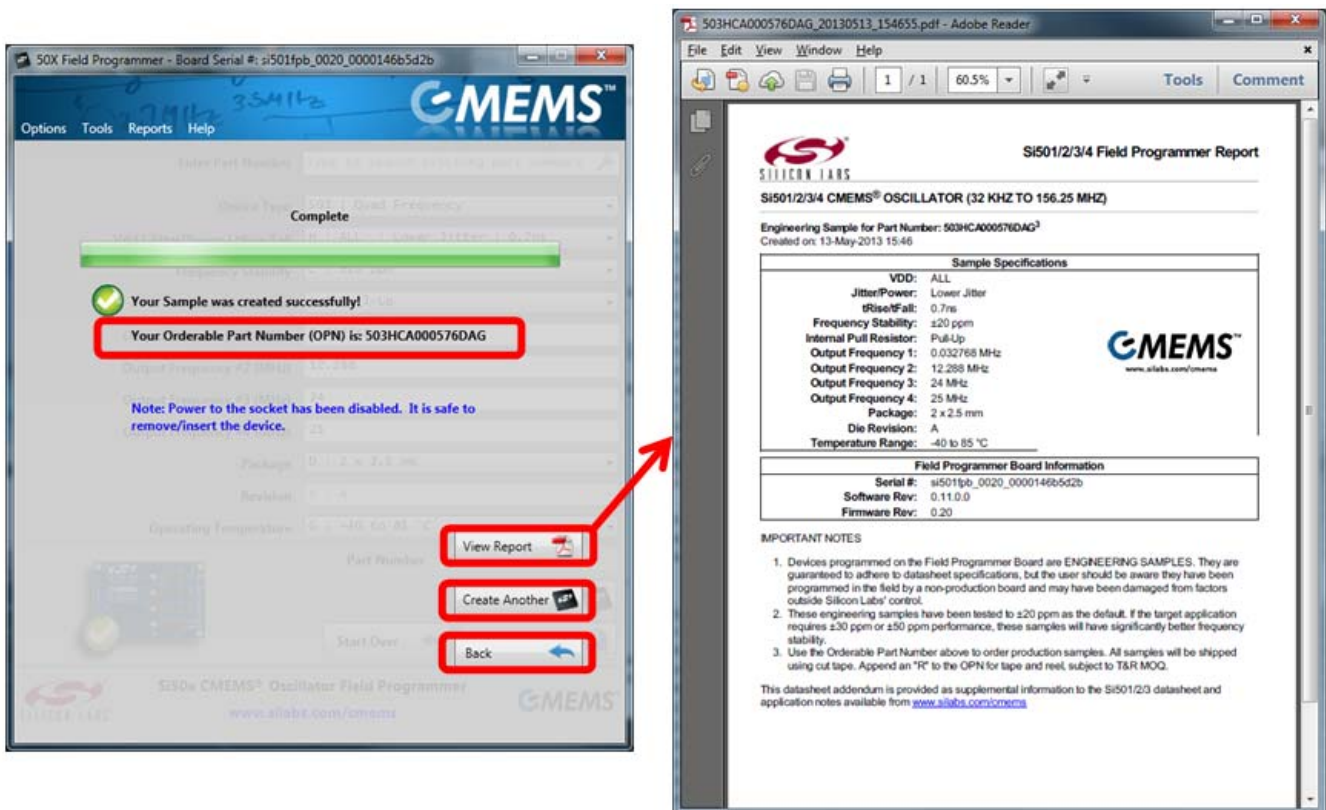

From the start page, you can select pulldown menu **Reports** and then directly select any of these options:

- View Latest Sample Report
- View Part Number History
- View All Sample Reports on Hard Drive

Si50x-FPB1-CUST

In the future, you can select the Back button and then search for the existing part number in the Enter Part Number field.

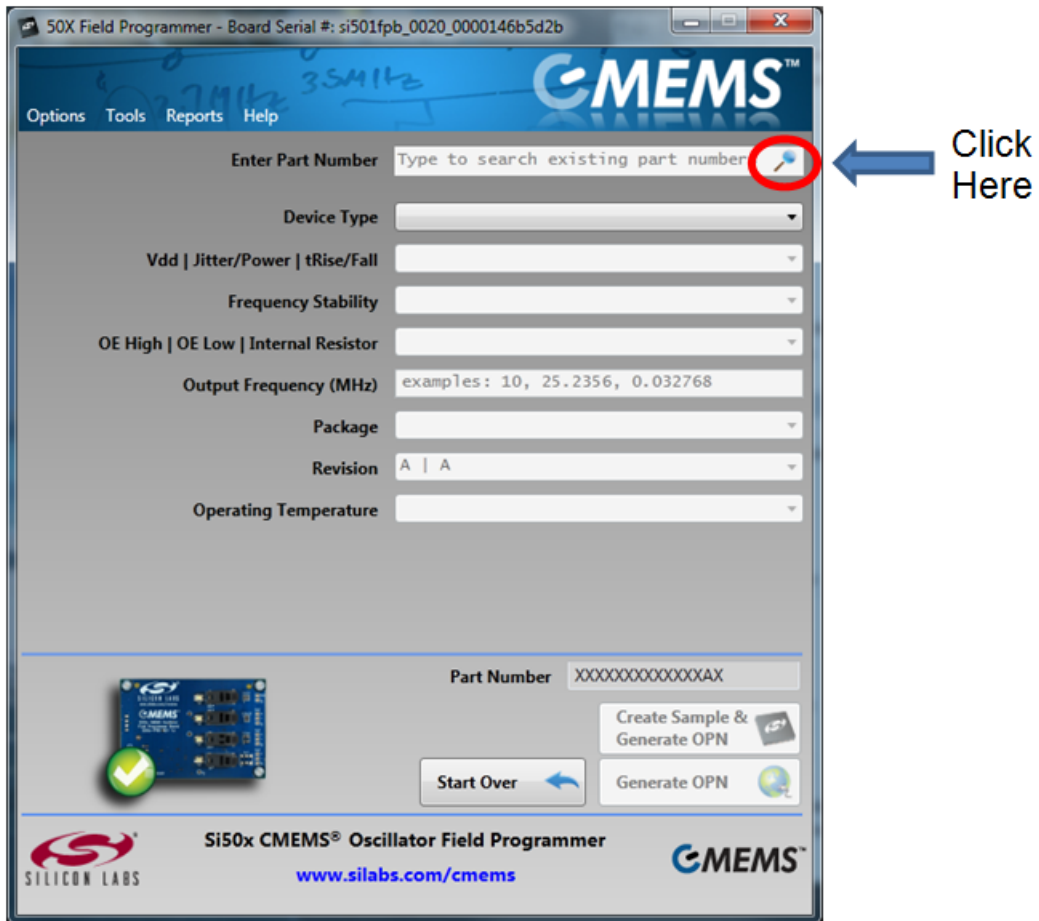

Part numbers representing the programmer's history will be listed as in the figure below. You can then double-click on the row to select a particular part number such as **501AAA15M0000BAF**, which has been generated in the example. All fields are populated with that part number's information on the start page and a part sample of your selection can be created as previously shown.

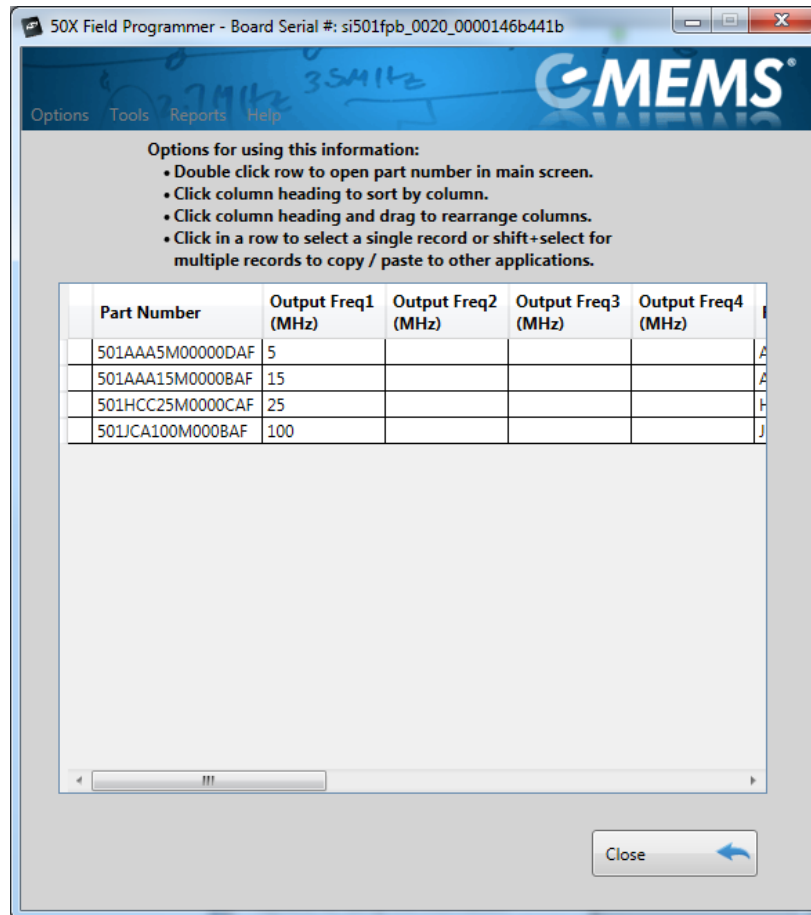

To exit the application, go back to the start page and select the pull down menu **Options** → **Exit**.

Si50x-FPB1-CUST

14. Help

Help is available in various forms. “Hovering” the cursor over an entry or image on the start page, for example, will yield a brief explanation in context. For an example of this “hover help”, please see the figure below. In this case, the cursor was placed over the board image in the lower left hand corner, which triggered an information window containing the board serial number and F/W and S/W revisions.

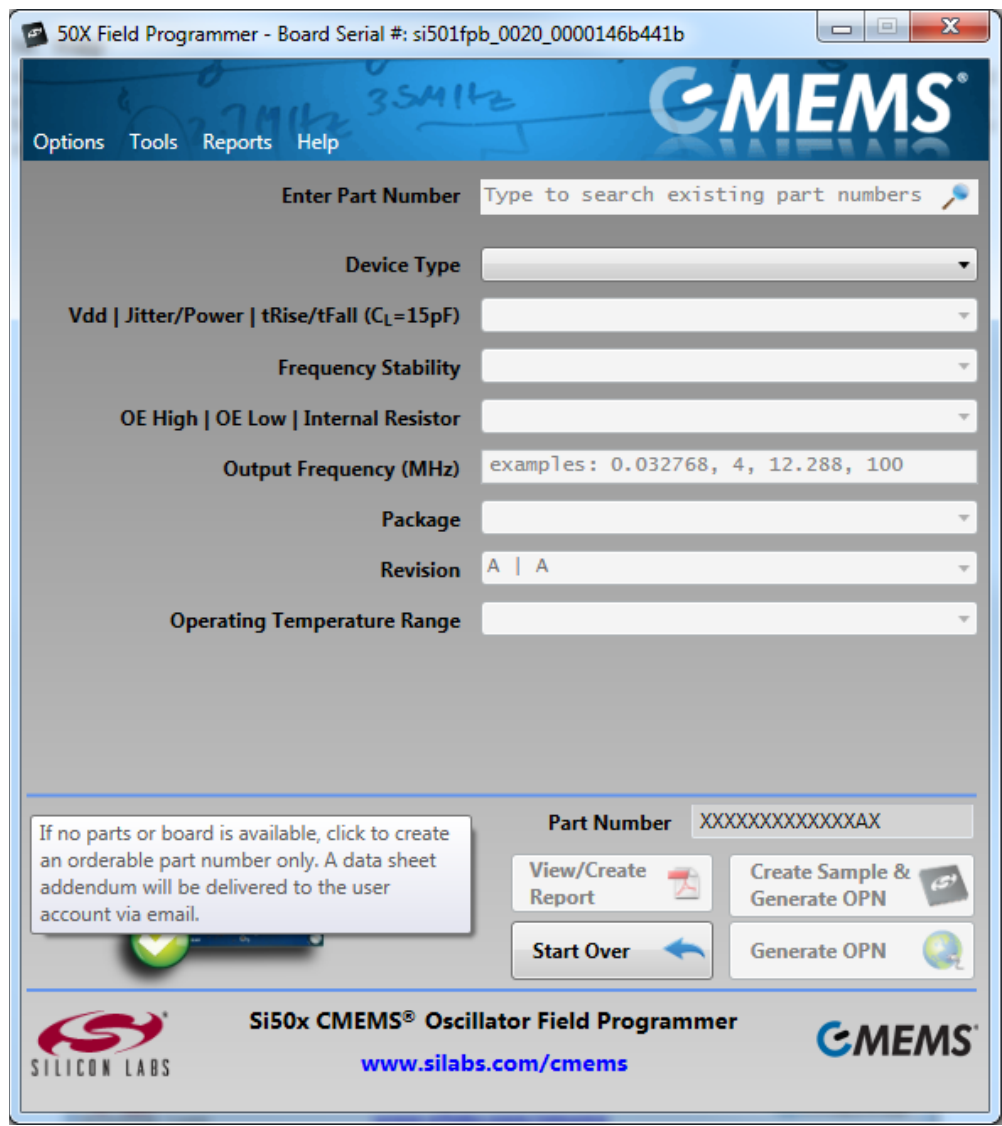

Si50x-FPB1-CUST

Additional help is available by selecting the Help pulldown menu and then selecting one of the options listed as illustrated below. Note that retrieval of the latest version of the User's Guide (this document) and Device Datasheet will require internet access.

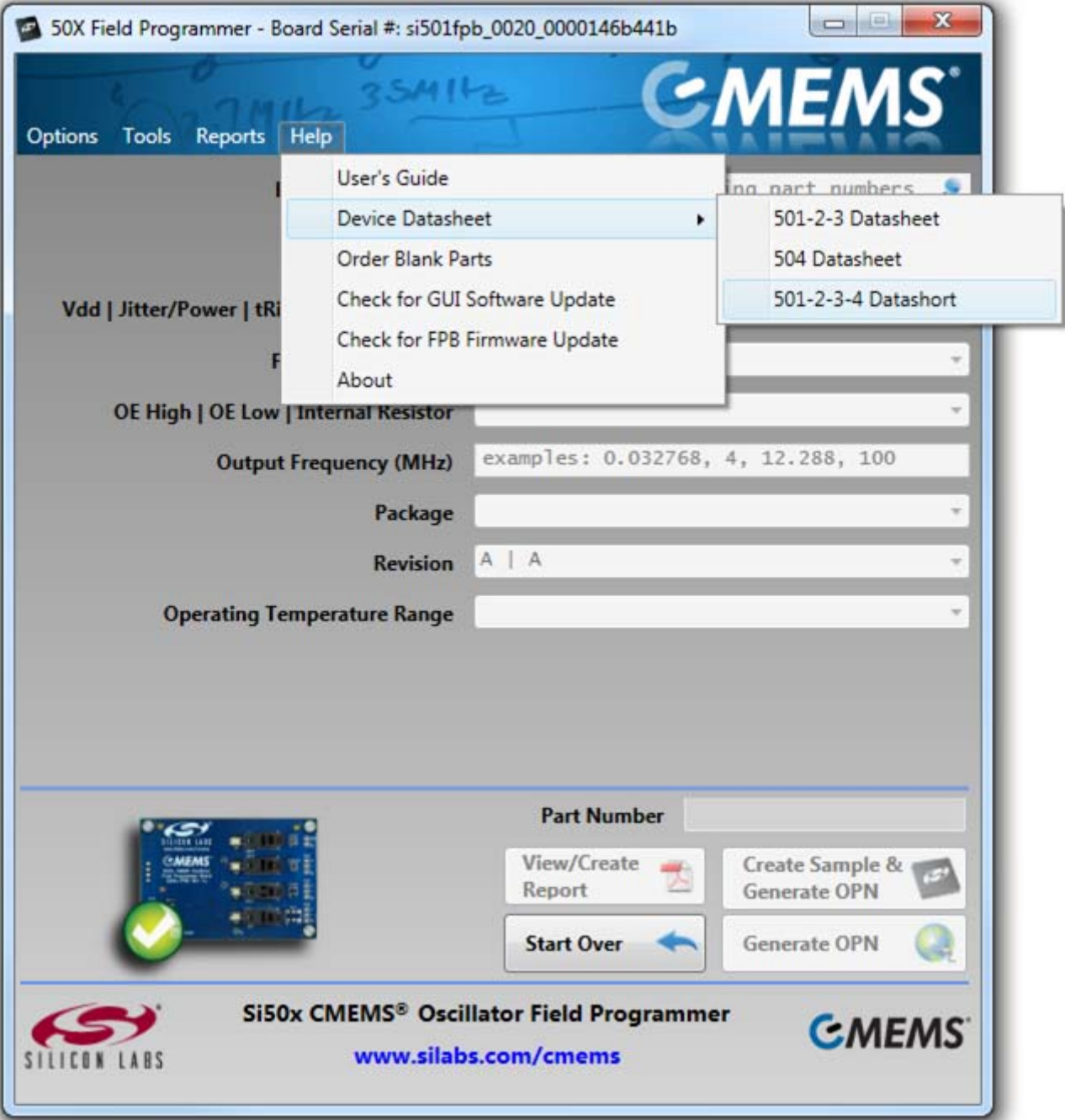

Si50x-FPB1-CUST

15. Tools

There are a number of useful items available under the start page menu, **Tools**, as illustrated in the screen capture below. In this first example, **Control Programmer Board** has been selected.

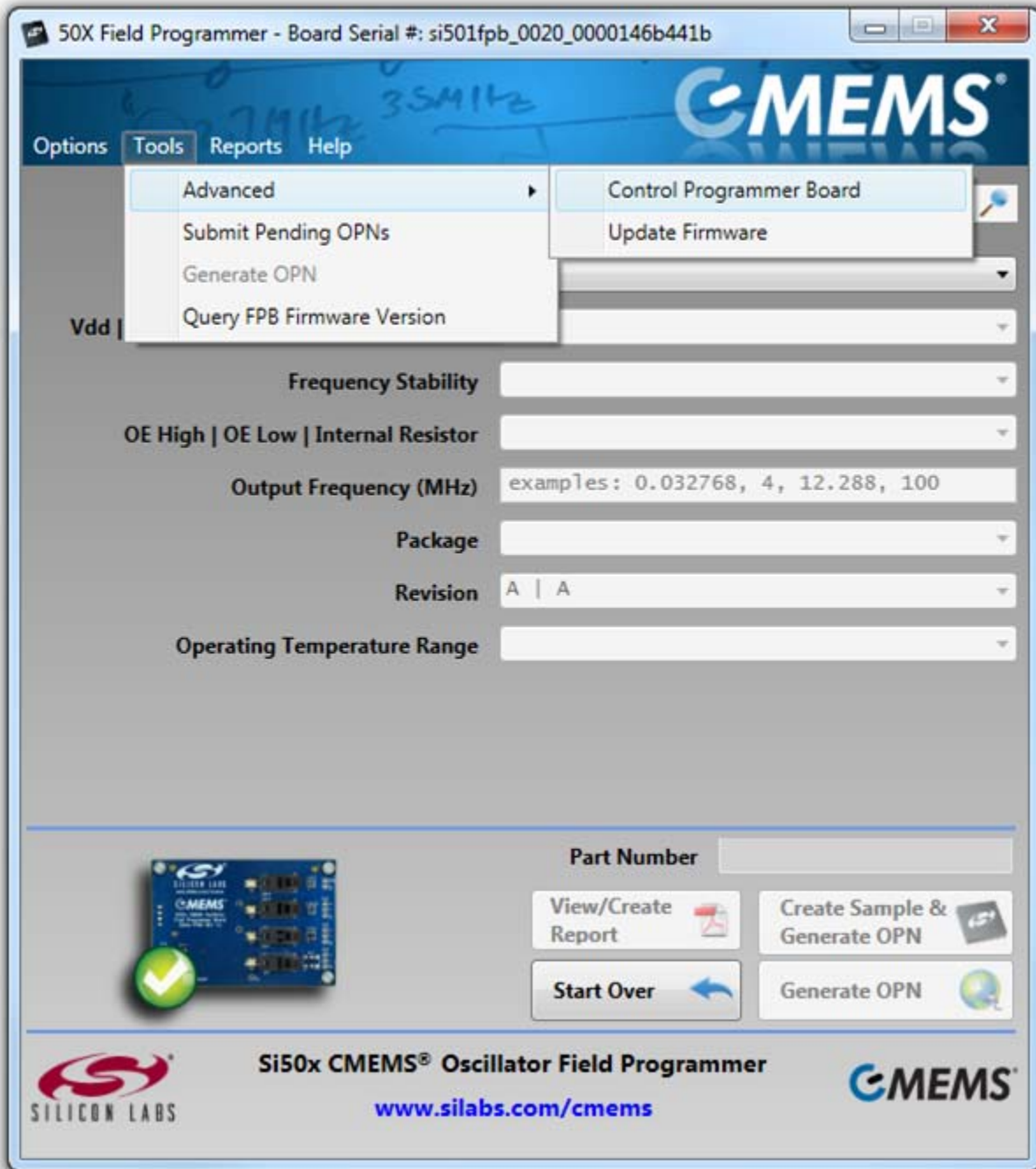

Selecting **Control Programmer Board** yields the following useful page which gives the user control over the DUT's VDD and the polarity of the Output Enable (OE) signal. The signal can be probed at the output test points to verify proper operation of the part.

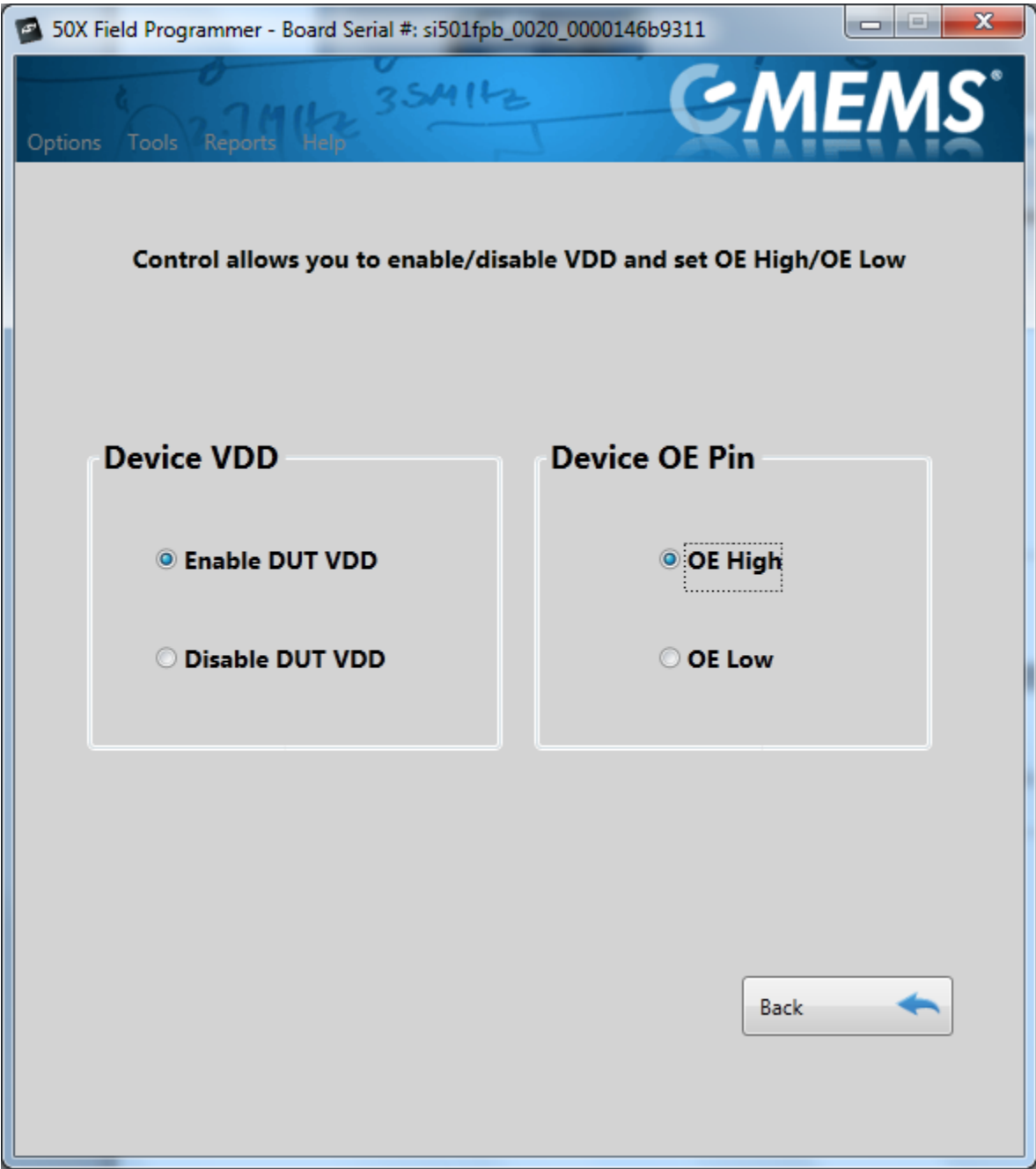

Si50x-FPB1-CUST

Another useful feature is to select **Tools** → **Check Device Orientation**. If a single DUT is properly oriented in the socket, the GUI will report as follows.

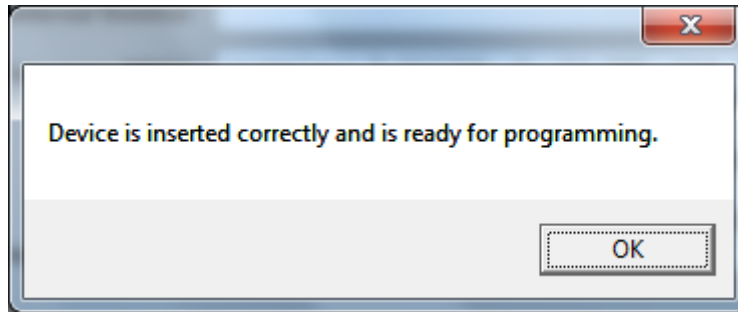

If not, then the FPB GUI will report one of several error messages as necessary depending on the situation:

- "Sockets are empty"
- "Device is inserted backwards"
- "Multiple sockets are populated with devices"

14. Si50x CMEMS™ Field Programmer Oscillator Software Uninstall

Close all the programs and help files before running the uninstaller to ensure complete removal of the software. To uninstall the software, use the Add and Remove Programs utility in the Control Panel or click **Start** → **All Programs** → **Silicon Laboratories** → **Si50x Field Programmer** → **Uninstall Si50x Field Programmer**.

The EVB Driver (USBXpress®) software must be uninstalled separately via the host PC's Control Panel. Locate and select the entry Silicon Laboratories USBXpress Device (Driver Removal) as in the figure below and click Uninstall / Change.

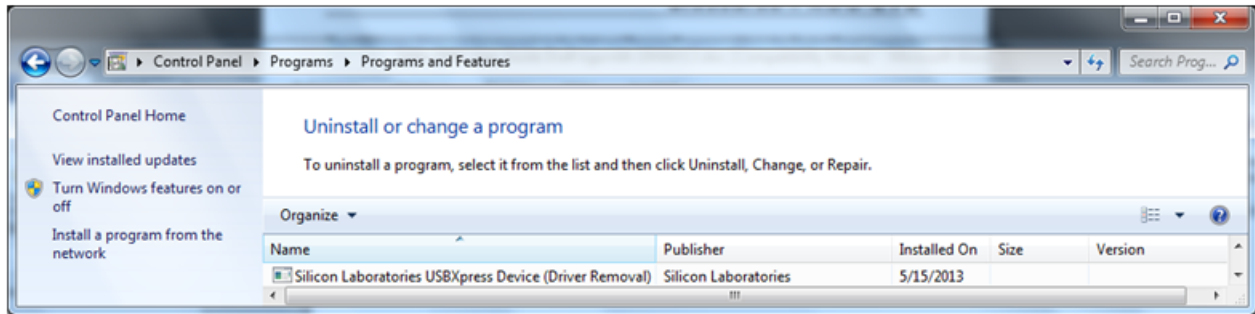

Si50x-FPB1-CUST

15. Schematics

15.1. MCU & USB

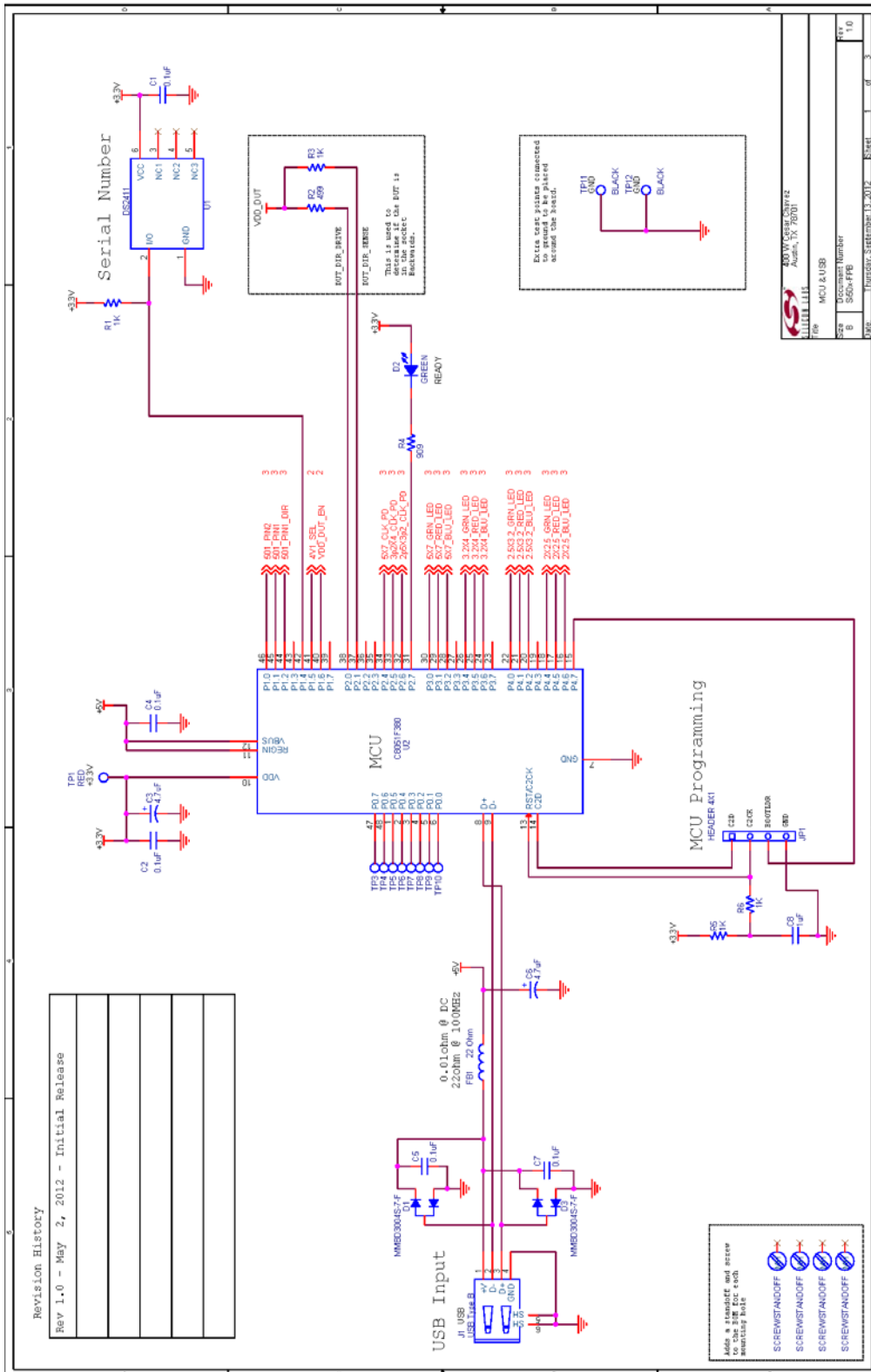

Figure 14. MCU & USB, Sheet 1 of 3

15.2. Voltage Regulators

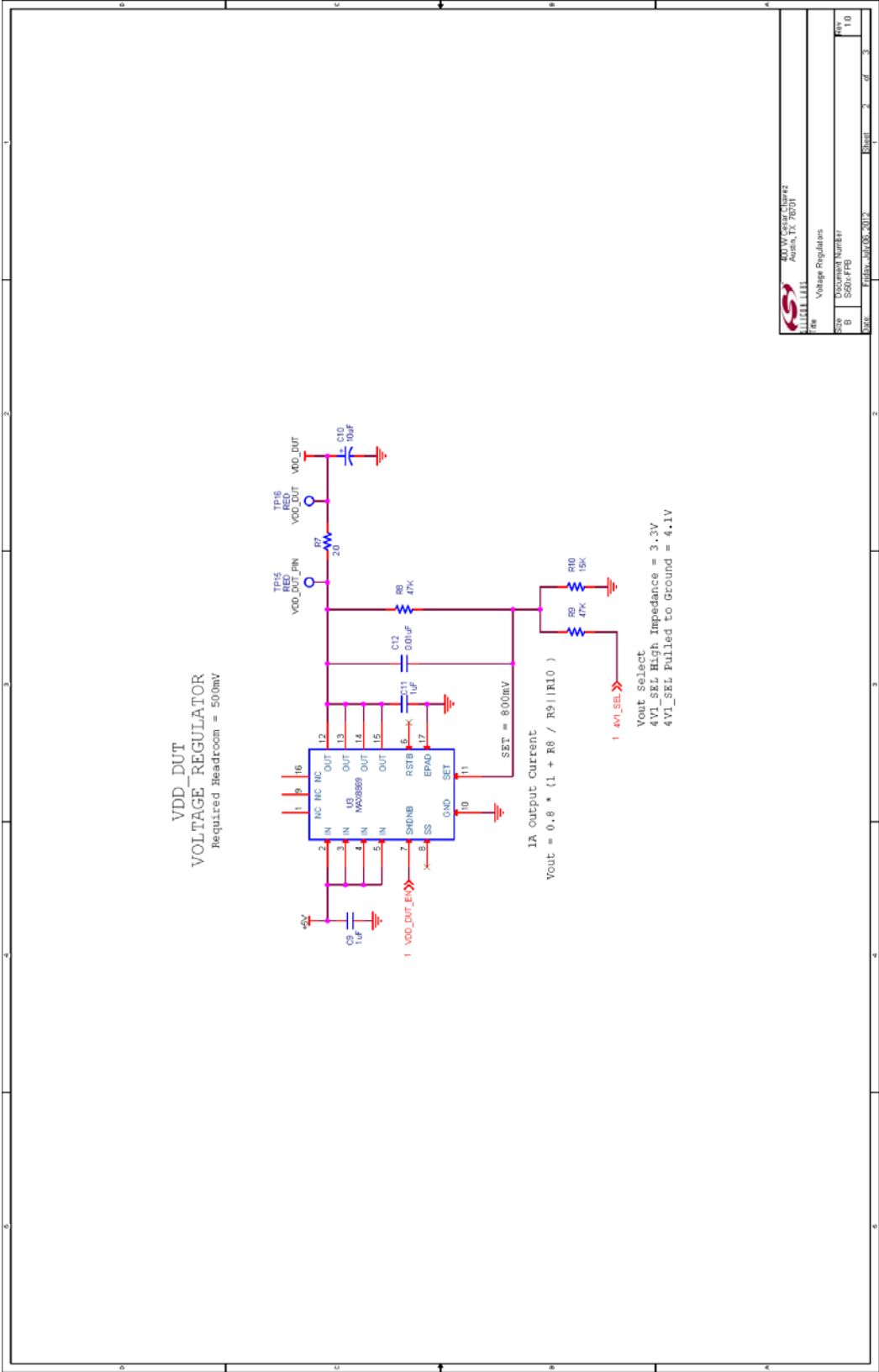
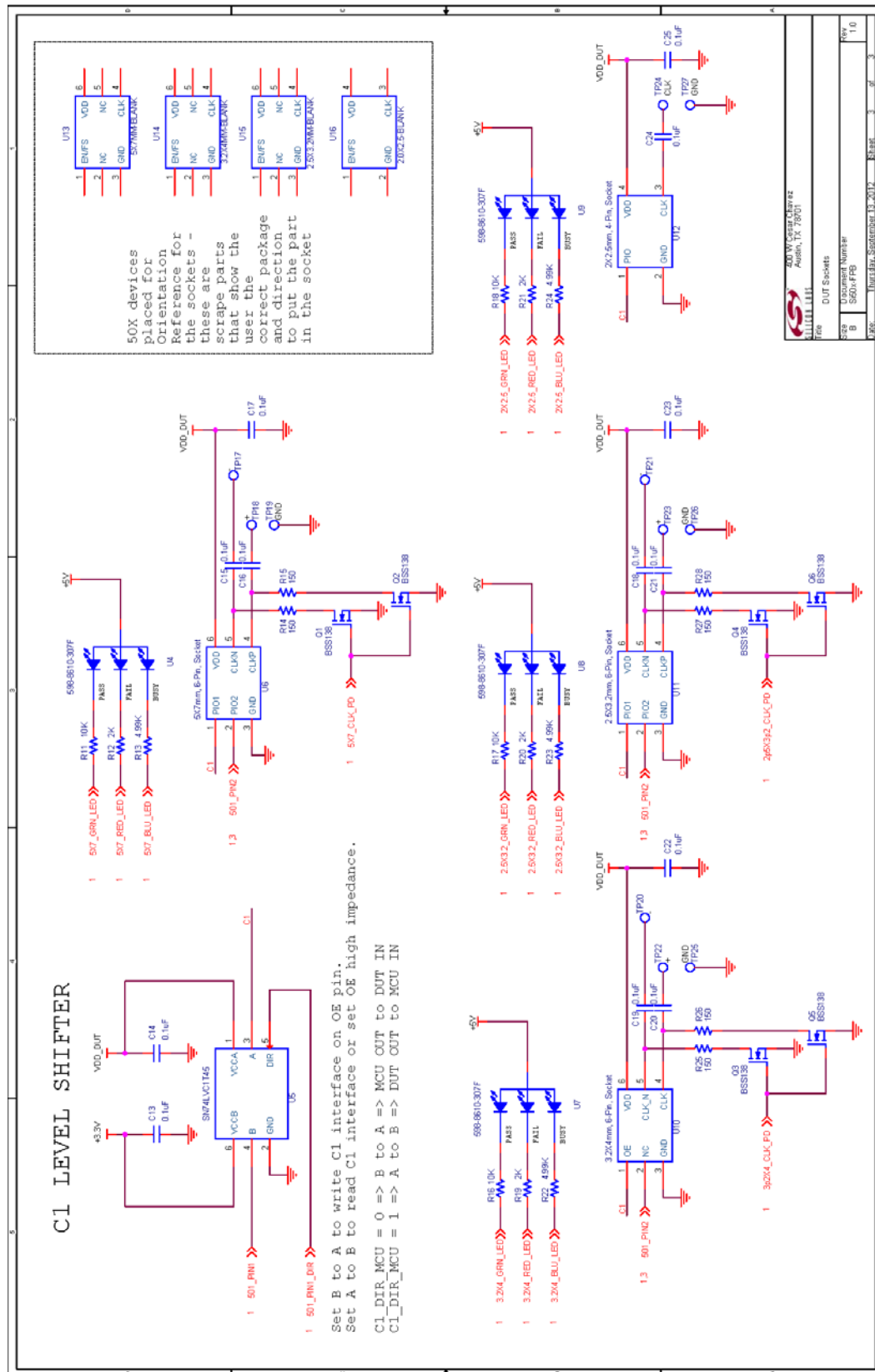

Figure 15. Voltage Regulators, Sheet 2 of 3

15.3. DUT Sockets



File	500176227_Chipset
Rev	1.0
Part No.	500176227
Project	13-2017
Sheet	3 of 3

Figure 16. DUT Sockets, Sheet 3 of 3



16. Bill of Materials

Table 5. Si50x-FPB Eval Board Bill of Materials Rev 1.0

NI	Qty	Reference	Value	Rating	Volt	Tol	Type	PCB_Footprint	ManufacturerPN	Manufacturer
	18	C1 C2 C4 C5 C7 C13 C14 C15 C16 C17 C18 C19 C20 C21 C22 C23 C24 C25	0.1 μ F		10 V	\pm 10%	X7R	C0402	C0402X7R100-104K	Venkel
	1	C10	10 μ F		25 V	\pm 20%	TANT	C6032	T491C106M025ZT	Kemet
	1	C12	0.01 μ F		10 V	\pm 20%	X7R	C0402	C0402X7R100-103M	Venkel
	2	C3 C6	4.7 μ F		10 V	\pm 20%	TANT	C3216	TAJA475M010RNJ	AVX
	3	C8 C9 C11	1 μ F		10 V	\pm 10%	X7R	C0603	C0603X7R100-105K	Venkel
	2	D1 D3	MMBD3004S-7-F	225mA	300 V		Dual	SOT23-AKC	MMBD3004S-7-F	Diodes Inc.
	1	D2	GREEN	25mA				LED-0603	SML-LX0603SUGW	LUMEX INC
	1	FB1	22 Ω	6000mA			SMT	L0805	BLM21PG220SN1	MuRata
	1	J1	USB Type B				USB	CONN-USB-B	292304-1	Tyco
	4	MH2 MH3 MH4 MH5	SCREW/STANDOFF				HDW		NSS-4-4-01/2397	VARIOUS
	6	Q1 Q2 Q3 Q4 Q5 Q6	BSS138	200mA	50 V		N-CHNL	SOT23-GSD	BSS138	Diodes Inc.
	4	R1 R3 R5 R6	1K	1/16W		\pm 1%	ThickFilm	R0402	CR0402-16W-1001F	Venkel
	1	R10	15K	1/16W		\pm 1%	ThickFilm	R0402	CR0402-16W-1502F	Venkel
	4	R11 R16 R17 R18	10K	1/16W		\pm 1%	ThickFilm	R0402	CR0402-16W-1002F	Venkel
	4	R12 R19 R20 R21	2K	1/16W		\pm 1%	ThickFilm	R0402	CR0402-16W-2001F	Venkel
	4	R13 R22 R23 R24	4.99K	1/16W		\pm 1%	ThickFilm	R0402	CR0402-16W-4991F	Venkel
	6	R14 R15 R25 R26 R27 R28	150	1/16W		\pm 1%	ThickFilm	R0402	CR0402-16W-1500F	Venkel
	1	R2	499	1/16W		\pm 1%	ThickFilm	R0402	CR0402-16W-4990F	Venkel
	1	R4	909	1/16W		\pm 1%	ThickFilm	R0805	CR0402-16W-9090F	Venkel
	1	R7	2.0	2W		\pm 1%	ThickFilm	R2512	CR2512-2W-2R00F	Venkel
	1	R8	47K	1/16W		\pm 1%	ThickFilm	R0402	CR0402-16W-4702F	Venkel
	1	R9	39.2K	1/16W		\pm 1%	ThickFilm	R0402	CR0402-16W-3922F	Venkel

Si50x-FPB1-CUST

Table 5. Si50x-FPB Eval Board Bill of Materials Rev 1.0 (Continued)

NI	Qty	Reference	Value	Rating	Volt	Tol	Type	PCB_Footprint	ManufacturerPN	Manufacturer
	1	U1	DS2411					SOJ6N4.45P1.27	DS2411P+	Maxim
	1	U10	3.2x4 mm, 6-Pin, Socket				DFN	DFN6N3.2X4-SKT-SER	AQ10001-P	SER
	1	U11	2.5x3.2 mm, 6-Pin, Socket				DFN	DFN6N2.5X3.2-SKT-SER	AM0295-580R	SER
	1	U12	2x2.5 mm, 4-Pin, Socket				DFN	DFN4N2X2.5-SKT-SER	AQ0015-520R	SER
	1	U13	5x7 mm-BLANK				Si50X	OSC6N7.0X5.0	501-PROG-AAX	SiLabs
	1	U14	3.2x4 mm-BLANK				Si50X	OSC6N3.2X4.0	501-PROG-BAX	SiLabs
	1	U15	2.5x3.2 mm-BLANK				Si50X	OSC6N3.2X2.5	501-PROG-CAX	SiLabs
	1	U16	2.0x2.5-BLANK				Si50X	OSC4N2.0X2.5	501-PROG-DAX	SiLabs
	1	U2	C8051F380				MCU	QFP48N9X9P0.5	CF380-PX0746GQ	SiLabs
	1	U3	MAX8869	1A			LDO	TSSOP16N6.5P0.65 E	MAX8869EUE50	Maxim
	4	U4 U7 U8 U9	598-8610-307F	20 mA				LED3-1210-KKKA	598-8610-307F	Dialight
	1	U5	SN74LVC1T45		1.65–5.5 V			SOT23-6N	SN74LVC1T45DBV	TI
	1	U6	5X7mm, 6-Pin, Socket				DFN	DFN6N5X7-SKT-SER	AM0393-1300R	SER
Not Installed Components										
NI	Qty	Reference	Value	Rating	Volt	Tol	Type	PCB_Footprint	ManufacturerPN	Manufacturer
NI	1	JP1	HEADER 4X1				Header	CONN-1X4	TSW-104-07-T-S	Samtec
NI	14	TP1 TP15 TP16 TP17 TP18 TP19 TP20 TP21 TP22 TP23 TP24 TP25 TP26 TP27	RED				Loop	TESTPOINT	151-207-RC	Kobiconn
NI	2	TP11 TP12	BLACK				Loop	TESTPOINT	151-203-RC	Kobiconn

17. Layout

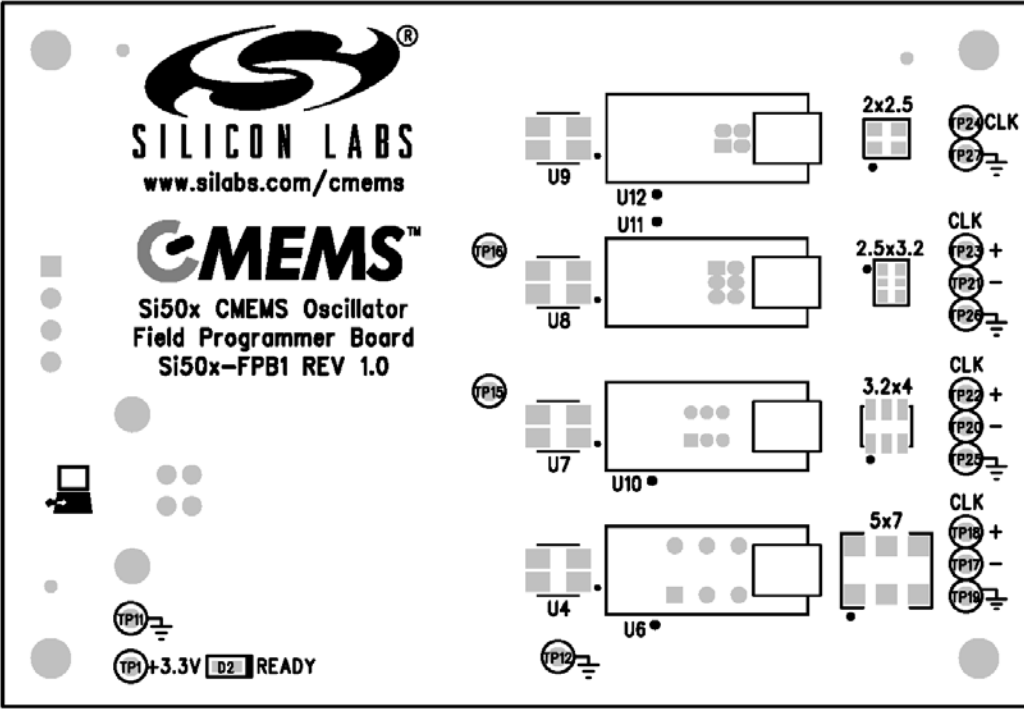

Figure 17. Primary Side Assembly

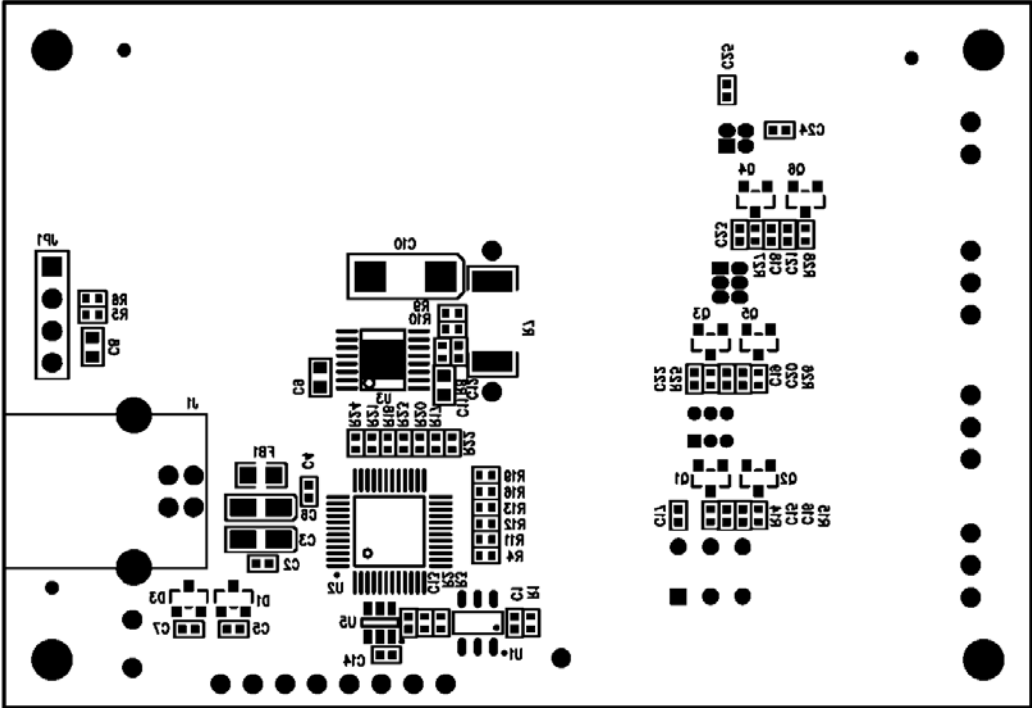

Figure 18. Secondary Side Assembly

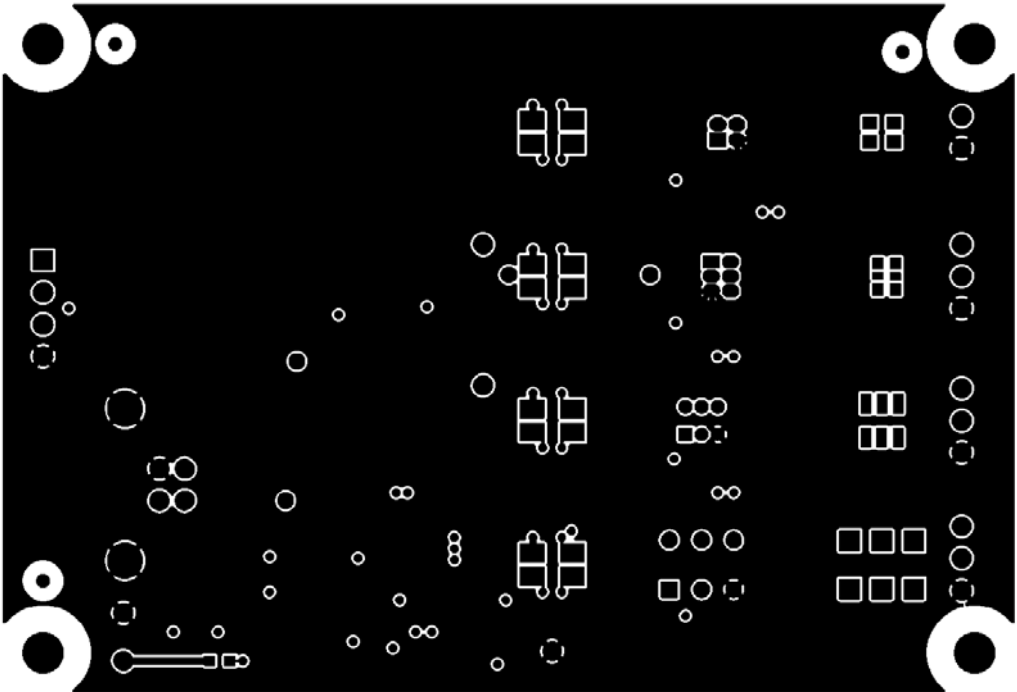

Figure 19. Primary Side (Layer 1)

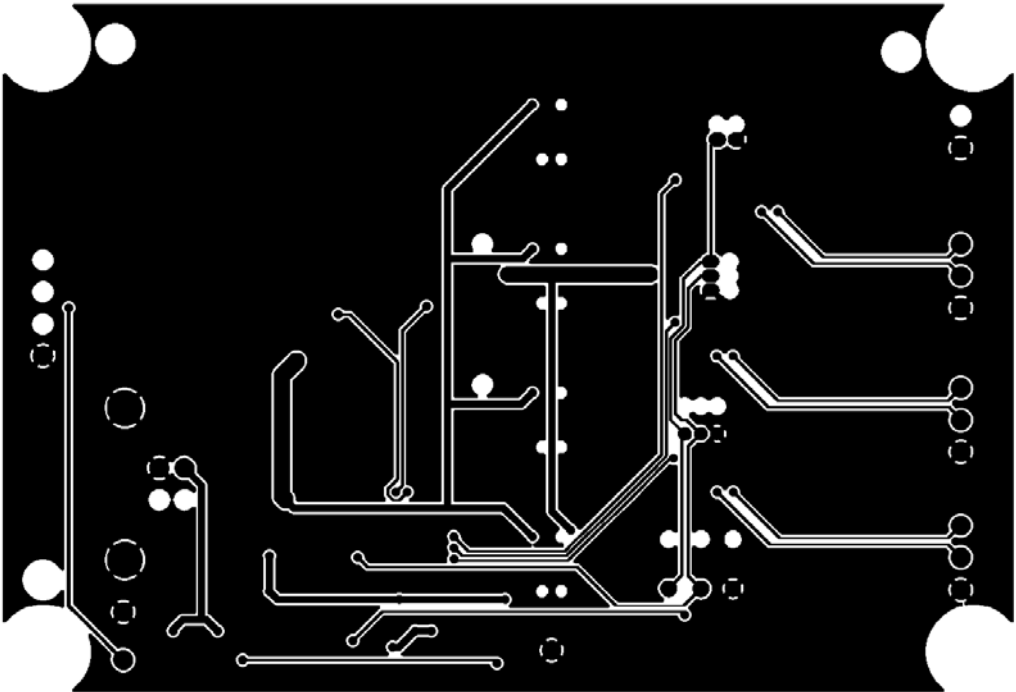

Figure 20. Signal/Ground (Layer 2)

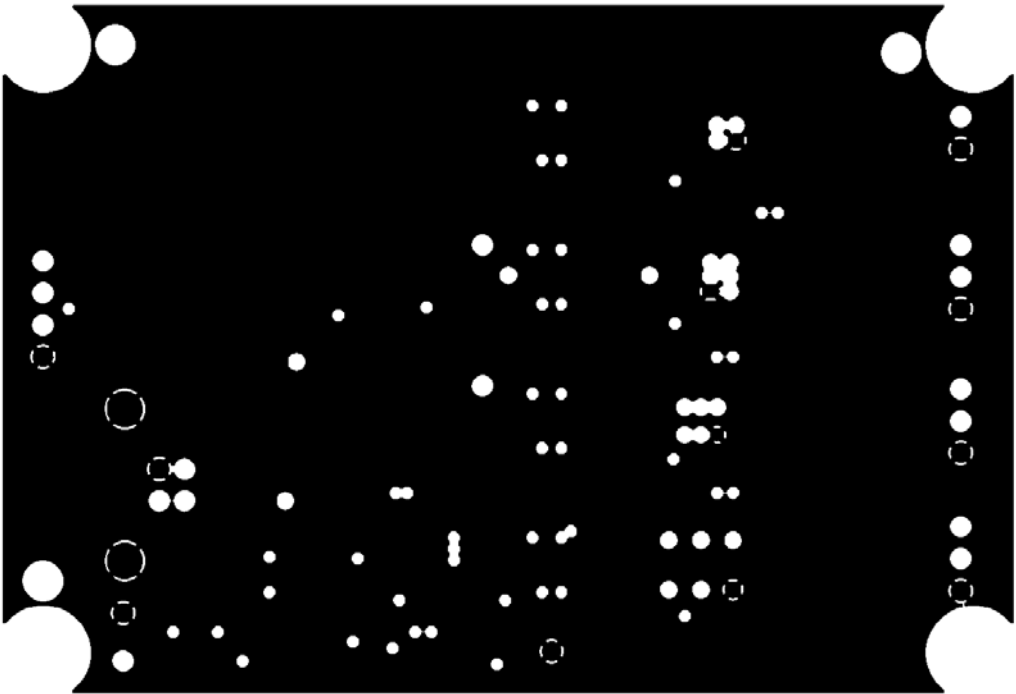

Figure 21. Ground (Layer 3)

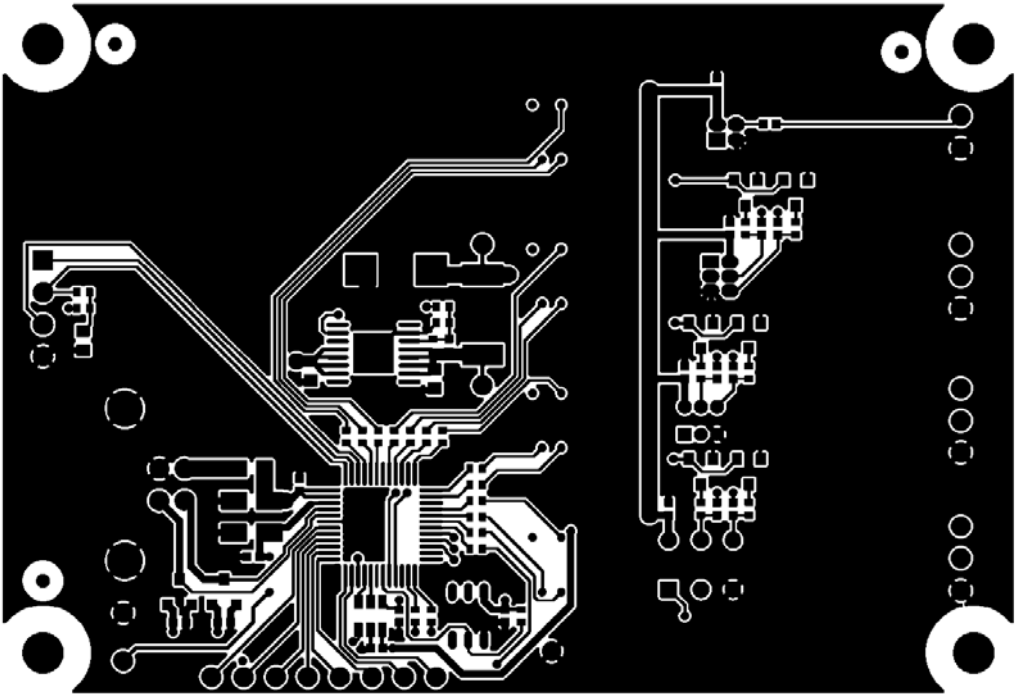

Figure 22. Secondary Side (Layer 4)

Si50x-FPB1-CUST

18. Fabrication Drawing

NOTES : UNLESS OTHERWISE SPECIFIED

1. MANUFACTURE IN ACCORDANCE WITH IPC-6012, TYPE 3, CLASS 2.
2. END PRODUCT FEATURES SHALL NOT VARY MORE THAN 20X FROM ARTWORK ORIGINALS.
3. LAMINATE AND PREPREG SHALL BE AS PER IPC-4101/26, B3, B8 WITH A DECOMPOSITION TEMPERATURE $\geq 345^{\circ}\text{C}$, COLOR, NATURAL.
4. COPPER WEIGHT SHALL BE 1.0 OZ./SQ. FT. BEFORE PLATING.
5. ALL PLATED THROUGH HOLES SHALL HAVE A MINIMUM OF 0.001" COPPER.
6. DRILL HOLE TOLERANCE AFTER PLATING SHALL BE ± 0.003 ".
7. MINIMUM ANNUAL RING SHALL BE 0.001".
8. MINIMUM ANNUAL RING AT EMERGENT CONDUCTORS SHALL BE 0.003".
9. MINIMUM ANNUAL RING SHALL BE 0.002" SIDE.
10. WARP/TWIST SHALL NOT EXCEED 0.010".
11. FINISH SHALL BE 1P, BLUE S.I.O.B.C. BALANCE ENG.
12. SILKSCREEN WITH MONOCONDUCTIVE WHITE & GRAY EPOXY INK.
13. REFERENCE ADDITIONAL FAB NOTES IN FILE README.TXT

LAYER STACKUP

PRIMARY SILK (GRAY)	50xFPB_PSS6.PHO
PRIMARY SILK (WHITE)	50xFPB_PSS.PHO
PRIMARY SOLDERMASK	50xFPB_FSM.PHO
PRIMARY SIDE	50xFPB_PRI.PHO
SIGNAL/GROUND	50xFPB_L02.PHO
GROUND PLANE	50xFPB_L03.PHO
SECONDARY SIDE	50xFPB_SEC.PHO
SECONDARY SOLDERMASK	50xFPB_SSM.PHO
SECONDARY SILKSCREEN	50xFPB_SSS.PHO

SCALE: NONE

PRIMARY DRILL

SIZE	QTY	SYM	PLT	TOOL	TOL
0.012	182	+	P	1	+0/-0.012
0.028	27	X	P	2	+/-0.003
0.040	24	□	P	3	+/-0.003
0.061	2	◇	P	4	+/-0.003
0.125	4	⊗	N	5	+/-0.003

COMPANY: 400 W. Caesar Chavez
AUSTIN, TX 78701
(512)486-8500
www.siliconlabs.com

SILICON LABS

NAME: SI50XFP1-EVB

REV: 1.0

SIZE: A

SCALE: 1:1

DO NOT SCALE DRAWING

FABRICATION DRAWING

SHEET 1 OF 1

CONTACT INFORMATION

Silicon Laboratories Inc.
400 West Cesar Chavez
Austin, TX 78701
Tel: 1+(512) 416-8500
Fax: 1+(512) 416-9669
Toll Free: 1+(877) 444-3032

Please visit the Silicon Labs Technical Support web page:
<https://www.silabs.com/support/pages/contacttechnicalsupport.aspx>
and register to submit a technical support request.

Patent Notice

Silicon Labs invests in research and development to help our customers differentiate in the market with innovative low-power, small size, analog-intensive mixed-signal solutions. Silicon Labs' extensive patent portfolio is a testament to our unique approach and world-class engineering team.

The information in this document is believed to be accurate in all respects at the time of publication but is subject to change without notice. Silicon Laboratories assumes no responsibility for errors and omissions, and disclaims responsibility for any consequences resulting from the use of information included herein. Additionally, Silicon Laboratories assumes no responsibility for the functioning of undescribed features or parameters. Silicon Laboratories reserves the right to make changes without further notice. Silicon Laboratories makes no warranty, representation or guarantee regarding the suitability of its products for any particular purpose, nor does Silicon Laboratories assume any liability arising out of the application or use of any product or circuit, and specifically disclaims any and all liability, including without limitation consequential or incidental damages. Silicon Laboratories products are not designed, intended, or authorized for use in applications intended to support or sustain life, or for any other application in which the failure of the Silicon Laboratories product could create a situation where personal injury or death may occur. Should Buyer purchase or use Silicon Laboratories products for any such unintended or unauthorized application, Buyer shall indemnify and hold Silicon Laboratories harmless against all claims and damages.

Silicon Laboratories and Silicon Labs are trademarks of Silicon Laboratories Inc.
Other products or brandnames mentioned herein are trademarks or registered trademarks of their respective holders.