

PLCC4 Surface Mount LED

OVSA1xBC2R8 Series

- High intensity with low power consumption
- PLCC4 packaged in 8 mm tape on 7" diameter reel
- Compatible with automatic placement equipment
- Dimensions: 3.2 x 2.7 x 1.95 mm
- 120° viewing angle



The **OVSA1xBC2R8** series is designed for wide angle, uniform light output. Its internal reflector and colorless clear lens optimize luminous intensity and make it ideal for backlighting applications and for coupling with light guides.

Applications

- Traffic lights
- Signal and symbol luminaire
- Mono-color indicators
- Backlighting (LCD, switches, displays, illuminated advertising)
- Interior automotive lighting (instrumentation clusters)
- Safety marker lights (steps, exit ways)

Part Number	Material	Emitted Color	Intensity Typ. mcd	Lens Color
OVSA1ABC2R8	AllnGaP	Amber	1500	Water Clear
OVSA1BBC2R8	InGaN	Blue	550	Water Clear
OVSA1GBC2R8	InGaN	Green	1800	Water Clear
OVSA1SBC2R8	AllnGaP	Red	1600	Water Clear

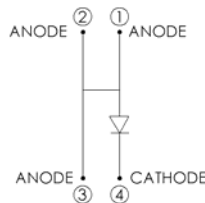
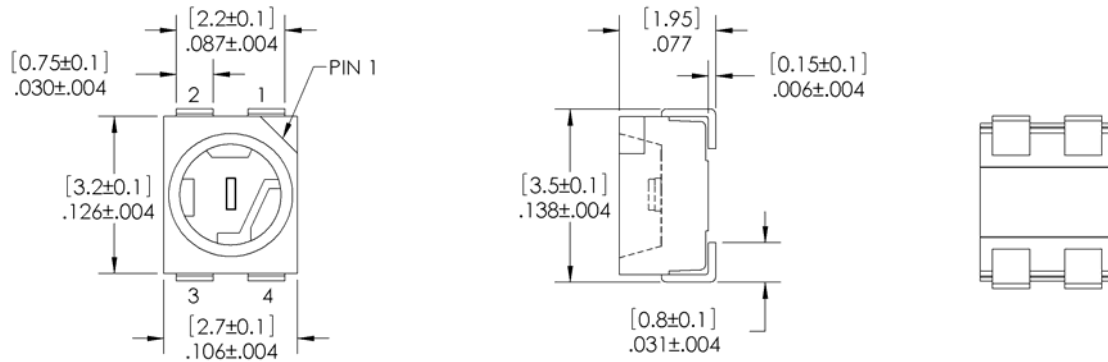

DIMENSIONS ARE IN INCHES AND [MM]

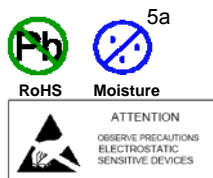

DO NOT LOOK DIRECTLY AT LED WITH UNSHIELDED EYES OR DAMAGE TO RETINA MAY OCCUR.

OPTEK reserves the right to make changes at any time in order to improve design and to supply the best product possible.

PLCC4 Surface Mount LED

OVSA1xBC2R8 Series



Absolute Maximum Ratings (T_A = 25° C unless otherwise noted)

Storage Temperature Range		-40 ~ +100 °C
Operating Temperature Range		-40 ~ +100 °C
Reverse Voltage		5 V
Continuous Forward Current	Blue, Green	30 mA
	Red, Amber	70 mA
Peak Forward Current (Pulse width ≤10 msec, duty cycle ≤10%)	Blue, Green	100 mA
	Red, Amber	200 mA
Power Dissipation	Blue, Green	130 mW
	Red, Amber	210 mW
Thermal Resistance Junction to Solder ^{1.}	Blue, Green	200° C/W
	Red, Amber	150° C/W
Electrostatic Discharge Classification (MIL-STD-883E)	Blue, Green	Class 2
	Red, Amber	
Moisture Sensitivity Level (IPC/JEDEC J-STD-020C)		5a / 24 hrs
LED Junction Temperature		110° C
Lead Soldering Temperature		250° C / 10 seconds

Note:

1. R_{th} test condition: Mounted on PC board FR 4 (pad size ≥16 mm²)

Electrical Characteristics (T_A = 25° C unless otherwise noted)

SYMBOL	PARAMETER	COLOR	MIN	TYP	MAX	UNITS	CONDITIONS
I _V	Luminous Intensity	Blue	355	550	---	mcd	I _F = 30 mA
		Green	1400	1800	---		
		Red	1120	1600	---		I _F = 50 mA
		Amber	1120	1500	---		
V _F	Forward Voltage	Blue	---	3.6	4.2	V	I _F = 30 mA
		Green	---	3.6	4.2		
		Red	---	2.4	3.0		I _F = 50 mA
		Amber	---	2.4	3.0		
I _R	Reverse Current	Blue	---	---	10	μA	V _R = 5 V
		Green	---	---	10		
		Red	---	---	10		
		Amber	---	---	10		
λ _D	Dominant Wavelength	Blue	460	470	480	nm	I _F = 30 mA
		Green	515	527	535		I _F = 50 mA
		Red	618	624	630		
		Amber	584	591	599		
2Θ _{1/2} H-H	50% Power Angle	Blue & Green		120		deg	I _F = 30 mA
		Red & Amber					I _F = 50 mA

OPTEK reserves the right to make changes at any time in order to improve design and to supply the best product possible.

PLCC4 Surface Mount LED

OVSA1xBC2R8 Series



Standard Bins

LEDs are sorted to luminous intensity (I_v) and dominant wavelength (nm) bins listed below. Each reel consists of a single intensity bin and a single color bin. Orders are filled using all intensity and color bins listed in the following tables. Optek will not accept orders for single intensity bins or single color bins.

Luminous Intensity (I_v) @ 30mA

BLUE: OVSA1BBC2R8		
IV Code	Min (mcd)	Max (mcd)
Tb	355	450
Ua	450	560
Ub	560	710
Va	710	900

Dominant Wavelength (nm)

BLUE: OVSA1BBC2R8		
nm Code	Min	Max
B3	460	465
B4	465	470
B5	470	475
B6	475	480

GREEN: OVSA1GBC2R8		
IV Code	Min (mcd)	Max (mcd)
Wb	1400	1800
Xa	1800	2240
Xb	2240	2800
Ya	2800	3550

GREEN: OVSA1GBC2R8		
nm Code	Min	Max
G6	515	520
G7	520	525
G8	525	530
G9	530	535

Luminous Intensity (I_v) @ 50mA

RED: OVSA1SBC2R8		
IV Code	Min (mcd)	Max (mcd)
Wa	1120	1400
Wb	1400	1800
Xa	1800	2240
Xb	2240	2800

Dominant Wavelength (nm)

RED: OVSA1SBC2R8		
nm Code	Min	Max
RA	618	630

AMBER: OVSA1ABC2R8		
IV Code	Min (mcd)	Max (mcd)
Wa	1120	1400
Wb	1400	1800
Xa	1800	2240
Xb	2240	2800

AMBER: OVSA1ABC2R8		
nm Code	Min	Max
A2	584	587
A3	587	590
A4	590	593
A5	593	596
A6	596	599

OPTEK reserves the right to make changes at any time in order to improve design and to supply the best product possible.

PLCC4 Surface Mount LED

OVSA1xBC2R8 Series



Typical Electro-Optical Characteristics Curves OVSA1BBC2R8 (Blue) & OVSA1GBC2R8 (Green)

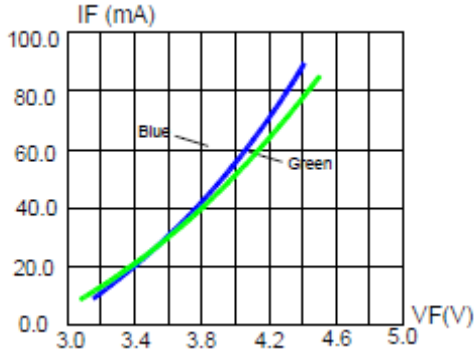

Forward Current vs. Forward Voltage

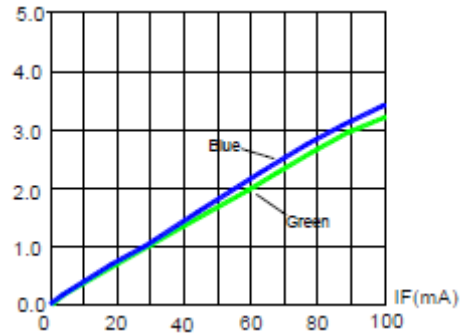

Relative Luminous Intensity vs. Forward Current

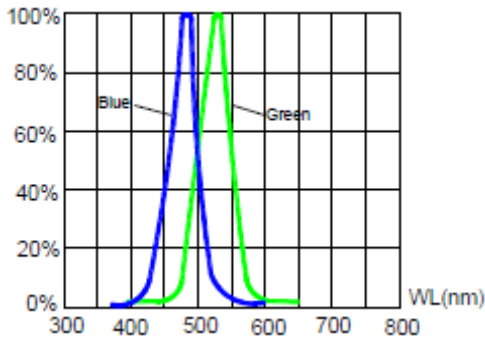

Relative Luminous Intensity vs. Wavelength

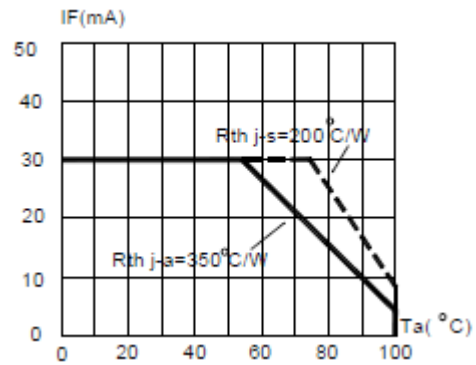

Blue & Green Maximum Forward DC Current vs. Ambient Temperature

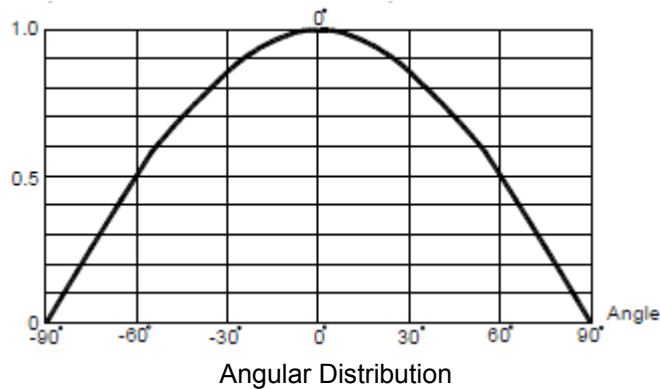

Angular Distribution

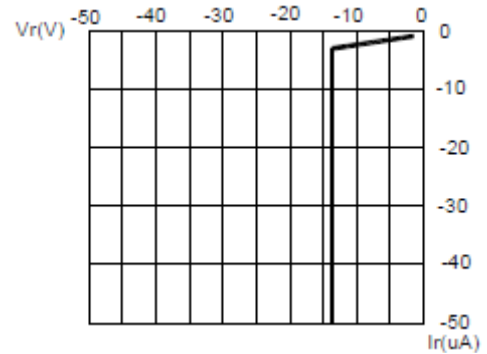

Blue & Green Reverse Current vs. Reverse Voltage

OPTEK reserves the right to make changes at any time in order to improve design and to supply the best product possible.

PLCC4 Surface Mount LED

OVSA1xBC2R8 Series

Typical Electro-Optical Characteristics Curves for OVSA1SBC2R8 (Red) & OVSA1ABC2R8 (Amber)

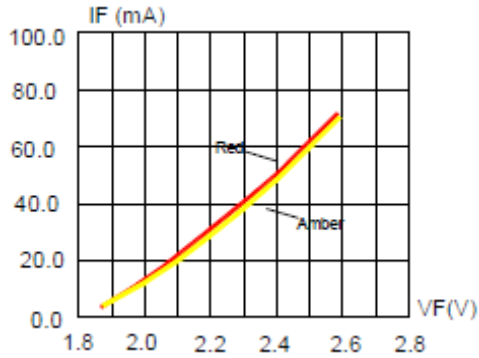

Forward Current vs. Forward Voltage

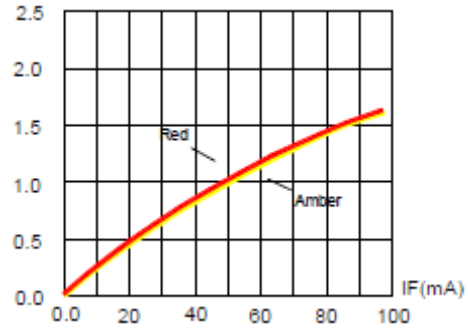

Relative Luminous Intensity vs. Forward Current

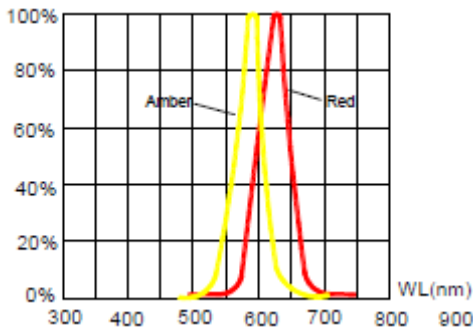

Relative Luminous Intensity vs. Wavelength

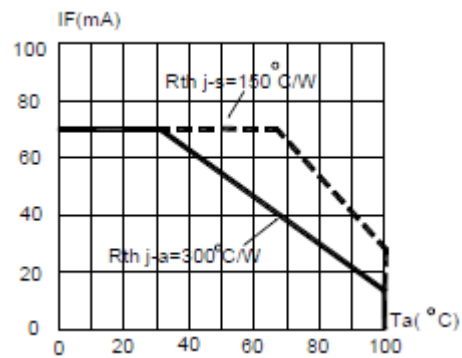

Red & Amber Maximum Forward DC Current vs. Ambient Temperature



Angular Distribution

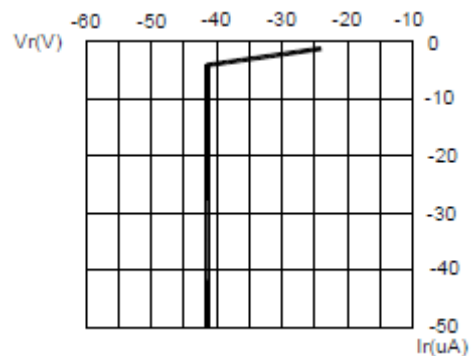

Red & Amber Reverse Current vs. Reverse Voltage

OPTEK reserves the right to make changes at any time in order to improve design and to supply the best product possible.

PLCC4 Surface Mount LED

OVSA1xBC2R8 Series

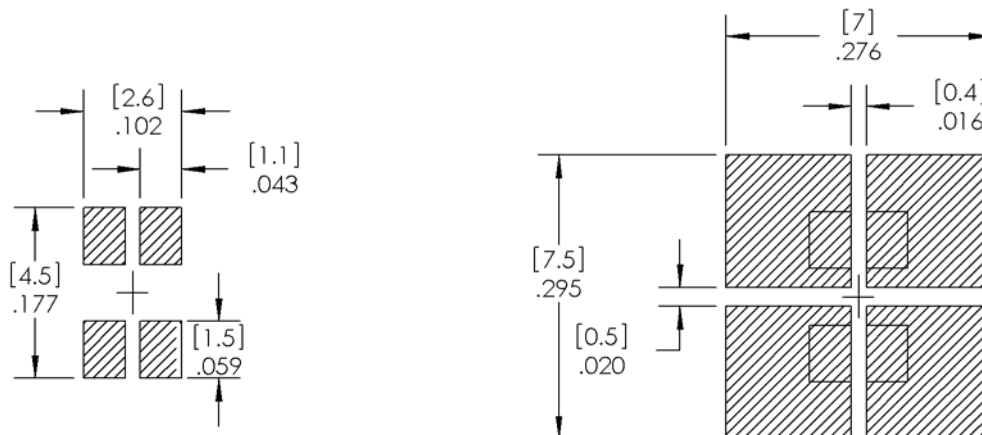

RECOMMENDED SOLDER PASTE PATTERN

RECOMMENDED COPPER PATTERN

Reflow Solder Profile

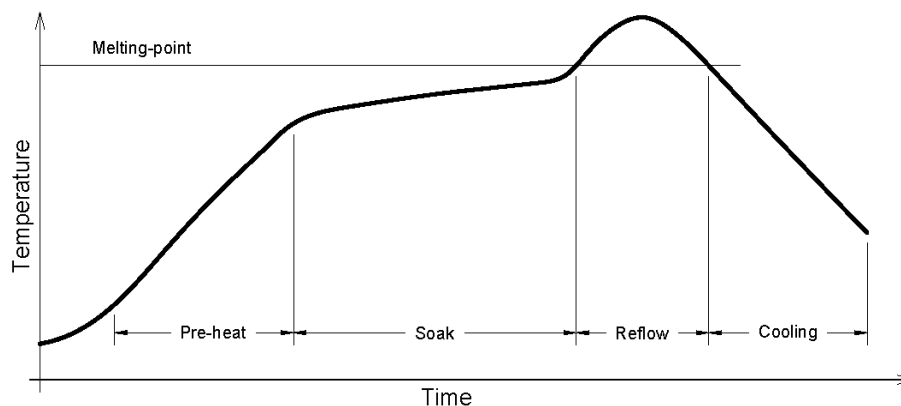

Solder = Lead-Free	
Average ramp-up rate = 4°C / sec. max	Peak temperature = 250°C max.
Preheat temperature: 150 - 220°C	Time within 5°C of actual peak temperature = 10 sec. max
Preheat time: 120 sec. max.	
Ramp-down rate = 6°C / sec. max.	Duration above 217°C is 60 sec. max

OPTEK reserves the right to make changes at any time in order to improve design and to supply the best product possible.

PLCC4 Surface Mount LED

OVSA1xBC2R8 Series

Reel Dimensions: 7-inch reel

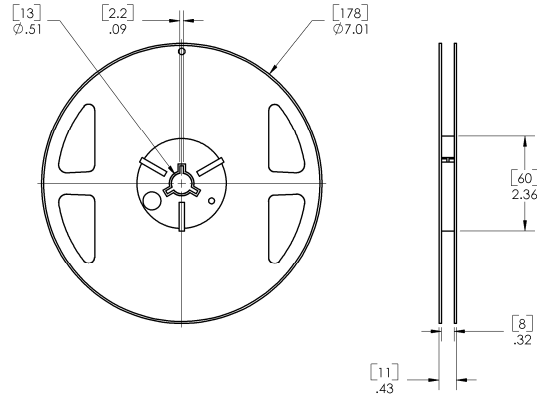

Carrier Tape Dimensions: Loaded Quantity 2000 pieces per reel

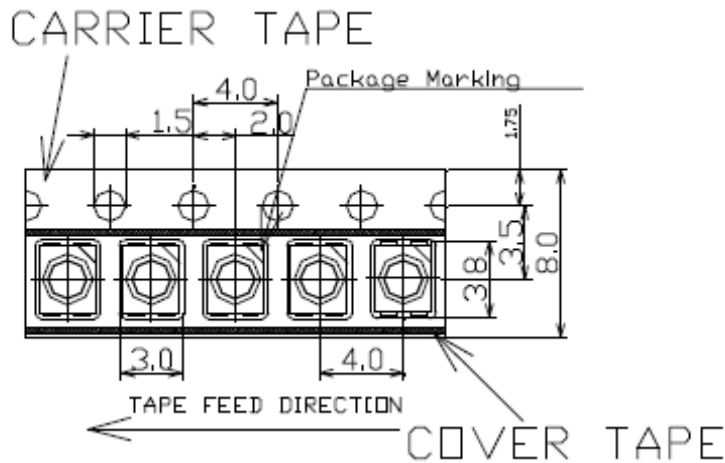

Moisture Resistant Packaging:

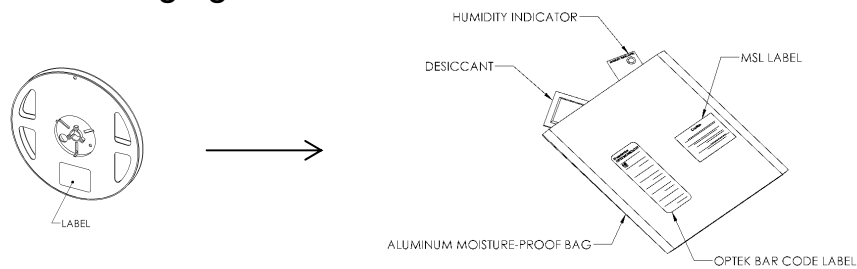

OPTEK reserves the right to make changes at any time in order to improve design and to supply the best product possible.