

San Ace 92W 9WL type

Splash Proof Fan

Features

Splash Proof and Dust Resistant

IP68^{*1} protection rating water and dust resistance.

Longest-Lasting Lifespan

These fans have an expected lifespan of 180,000 hours (approximately 20 years), about 4.5 times that of our conventional splash proof fan,^{*2} making them ideal for equipment that must operate without maintenance for extended periods.

High Air Flow and High Static Pressure

Maximum air flow increased by approximately 1.2 times and maximum static pressure increased by approximately 1.5 times compared with our conventional splash proof fan.^{*2}

Low Power Consumption

The power consumption is approximately 21% lower than that of our conventional splash proof fan.^{*3}

*1: Based on testing procedure for IEC (International Electrotechnical Commission) specification IEC 60529.

*2: Specification of Model No. 9WL0924PJ001. Our conventional splash proof fan is 92 x 92 x 25 mm "San Ace 92W", Model No. 9WP0924G401.

*3: Specification of Model No. 9WL0912P4G001. At equivalent air flow performance. Our conventional splash proof fan is 92 x 92 x 25 mm "San Ace 92W", Model No. 9WP0924G401.



92x92x25mm

Specifications

The following nos. have **PWM controls, pulse sensors.**

Model No.	Rated Voltage [V]	Operating Voltage Range [V]	PWM Duty Cycle <small>(Nom.±2)</small> [%]	Rated Current [A]	Rated Input [W]	Rated Speed [min ⁻¹]	Max. Air Flow [m ³ /min] [CFM]	MAX. Static Pressure [Pa] [inchH ₂ O]	SPL [dB(A)]	Operating Temperature [°C]	Expected Life [h]		
9WL0912P4J001	12	10.8 to 13.2	100	0.42	5.04	5,000	2.2 77.7	105 0.42	44	-20 to +70	180,000		
			20	0.04	0.48	1,200	0.52 18.4	6.04 0.024	11				
9WL0912P4G001			100	0.30	3.60	4,400	1.93 68.2	81 0.33	40				
			20	0.04	0.48	1,000	0.43 15.1	4.18 0.016	8				
9WL0912P4S001			100	0.22	2.64	3,850	1.69 59.7	62.1 0.25	37				
			30	0.04	0.48	1,400	0.61 21.5	8.21 0.032	13				
9WL0912P4H001			100	0.15	1.80	3,150	1.38 48.7	41.6 0.17	32				
			30	0.04	0.48	1,100	0.48 16.9	5.07 0.020	9				
9WL0924P4J001			24	21.6 to 26.4	100	0.21	5.04	5,000	2.2 77.7			105 0.42	44
					20	0.02	0.48	1,100	0.48 16.9			5.07 0.020	9
9WL0924P4S001					100	0.11	2.64	3,850	1.69 59.7			62.1 0.25	37
					30	0.02	0.48	1,300	0.57 20.1			7.08 0.028	12
9WL0924P4H001	100	0.07			1.68	3,150	1.38 48.7	41.6 0.17	32				
	30	0.02			0.48	1,000	0.43 15.1	4.18 0.016	8				

Note1: PWM Frequency: 25 kHz

Note2: Fans do not rotate when PWM duty cycle is 0%.

Available options: Without Sensor Pulse Sensor Lock Sensor

Common Specifications

- Material Frame: Aluminum (Black coating), Impeller: Plastics (Flammability: UL94V-1)
- Expected Life Refer to specifications
(L10: Survival rate: 90% at 60 °C, rated voltage, and continuously run in a free air state)
- Motor Protection System Current blocking function and reverse polarity protection
- Dielectric Strength 50 / 60 Hz, 500 VAC, 1 minute (between lead conductor and frame)
- Sound Pressure Level (SPL) Expressed as the value at 1 m from air inlet side
- Operating Temperature Refer to specifications (Non-condensing)
- Storage Temperature -30 °C to +70 °C (Non-condensing)
- Lead Wire ⊕Red ⊖Black Sensor: Yellow Control: Brown
- Mass Approx. 170 g

Air Flow - Static Pressure Characteristics

• PWM Duty Cycle

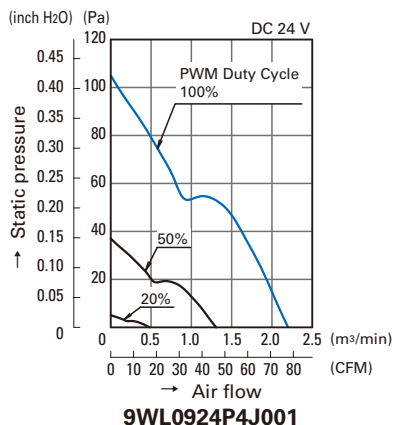
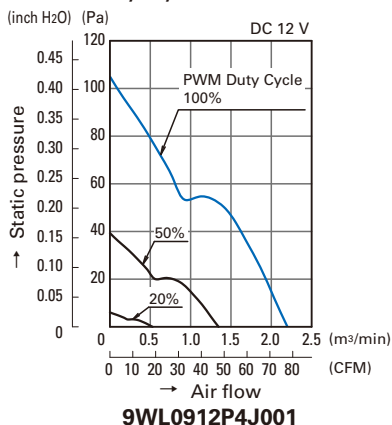

• Operating Voltage Range

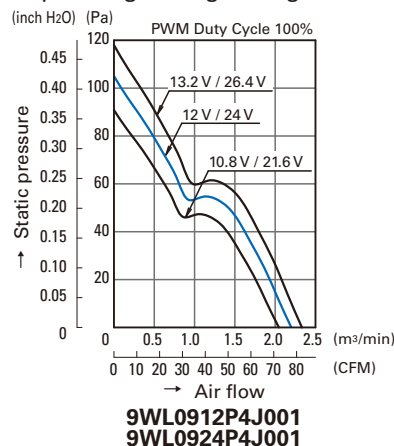

• PWM Duty Cycle

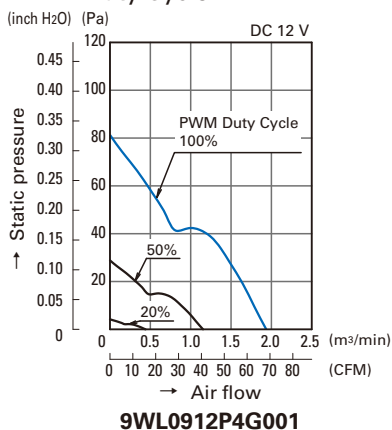

• Operating Voltage Range

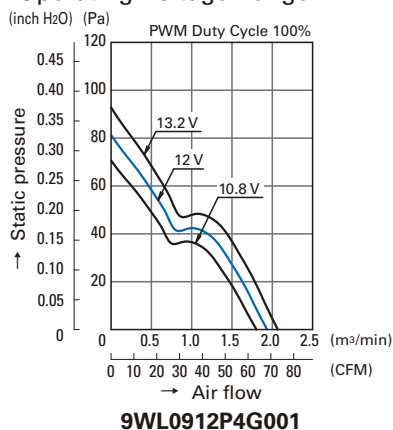

• PWM Duty Cycle

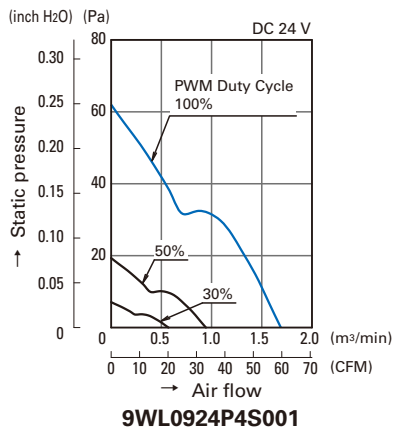
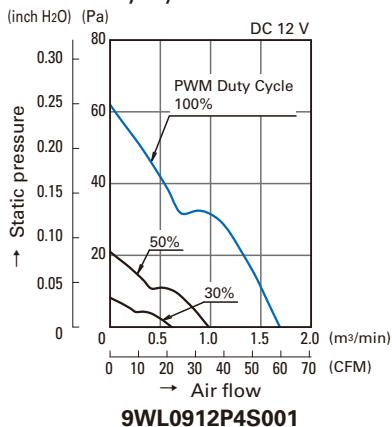

• Operating Voltage Range

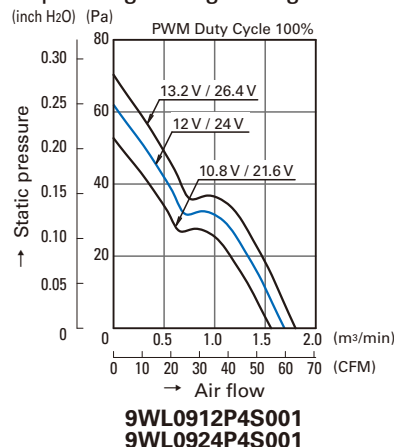

• PWM Duty Cycle

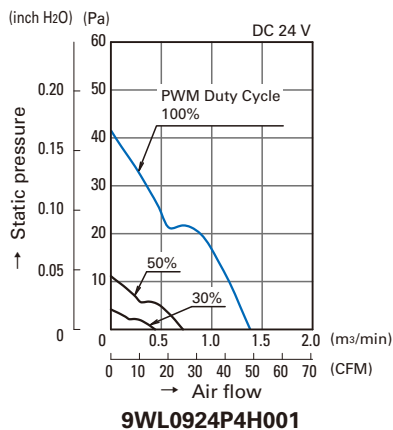
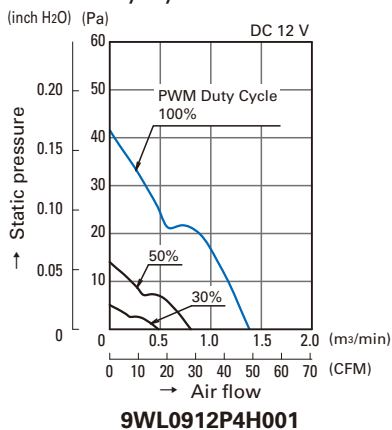

• Operating Voltage Range

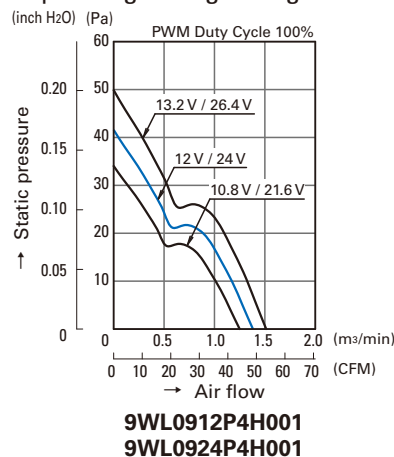

PWM Duty - Speed Characteristics Example

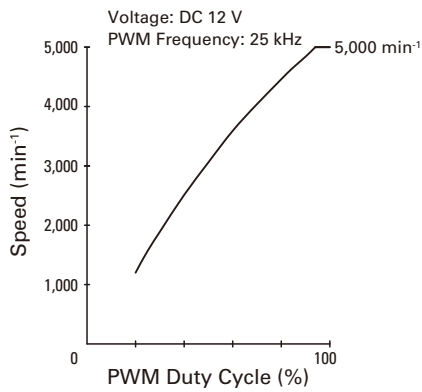

9WL0912P4J001

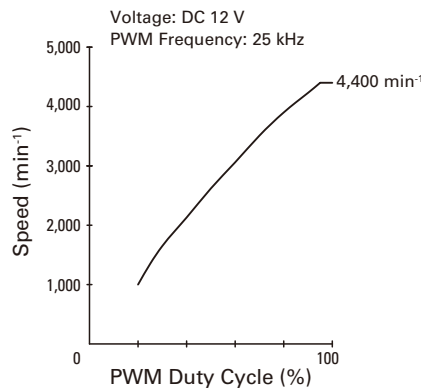

9WL0912P4G001

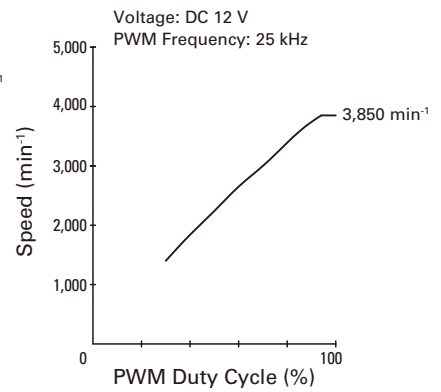

9WL0912P4S001

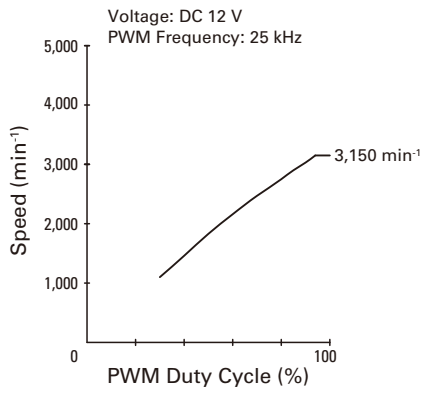

9WL0912P4H001

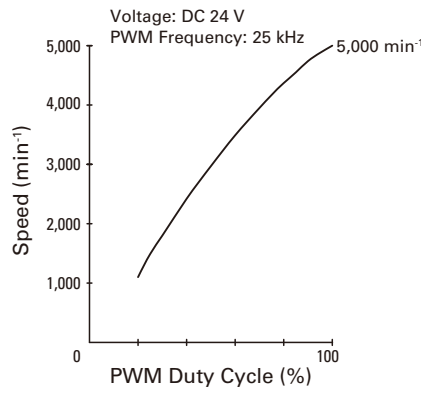

9WL0924P4J001

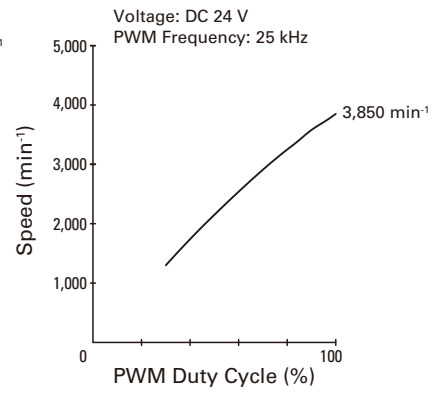

9WL0924P4S001

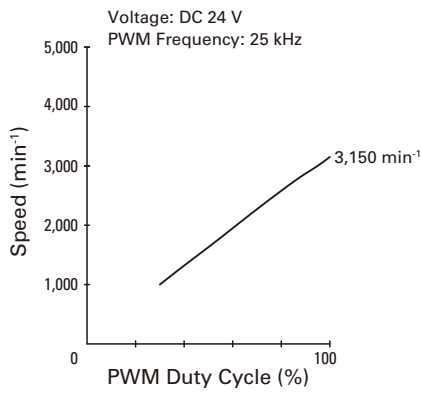

9WL0924P4H001

PWM Input Signal Example

Input Signal Waveform

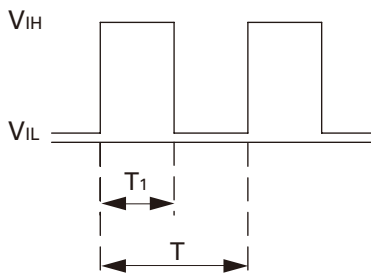

$V_{IH}=4.75\text{ V to }5.25\text{ V}$

$V_{IL}=0\text{ V to }0.4\text{ V}$

$$\text{PWM Duty Cycle (\%)} = \frac{T_1}{T} \times 100$$

$$\text{PWM Frequency } 25\text{ (kHz)} = \frac{1}{T}$$

Source Current (I_{source}) : 1 mA Max. at control voltage 0 V

Sink Current (I_{sink}) : 1 mA Max. at control voltage 5.25 V

Control Terminal Voltage: 5.25 V Max. (Open Circuit)

When the control lead wire is open, the fan speed is the same as the one at a PWM duty cycle of 100%.

Either TTL input, open collector or open drain can be used for PWM control input signal.

Example of Connection Schematic

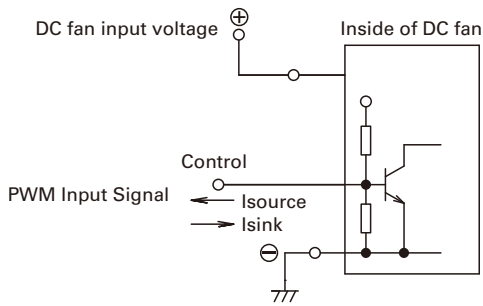

Specifications for Pulse Sensors

Output circuit: Open collector

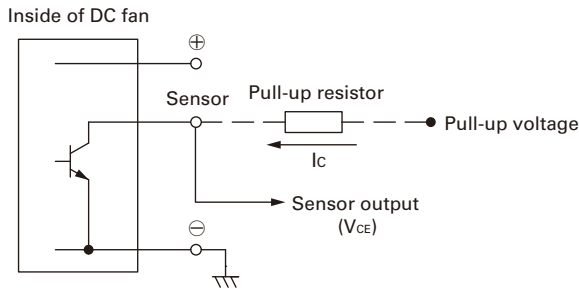

Rated Voltage 12 V Fan

$V_{CE} = +13.8 \text{ V MAX.}$
 $I_c = 5 \text{ mA MAX. [} V_{CE}(\text{SAT}) = 0.6 \text{ V MAX.]}$

Rated Voltage 24 V Fan

$V_{CE} = +27.6 \text{ V MAX.}$
 $I_c = 5 \text{ mA MAX. [} V_{CE}(\text{SAT}) = 0.8 \text{ V MAX.]}$

Output Waveform (Need pull-up resistor)

In case of steady running

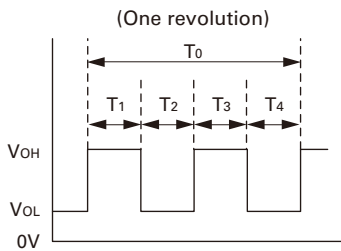

$$T_{1\sim 4} \doteq (1/4) T_0$$

$$T_{1\sim 4} \doteq (1/4) T_0 = 60/4N \text{ (sec)}$$

$$N = \text{Fan speed (min}^{-1}\text{)}$$

Dimensions (unit : mm)

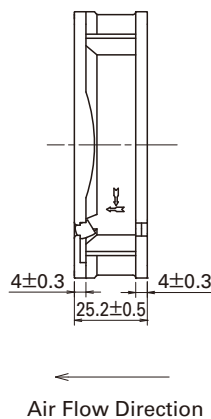
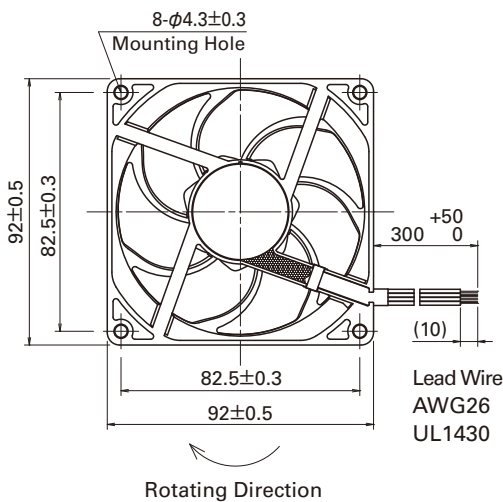

Reference Dimension of Mounting Holes and Vent Opening (unit : mm)

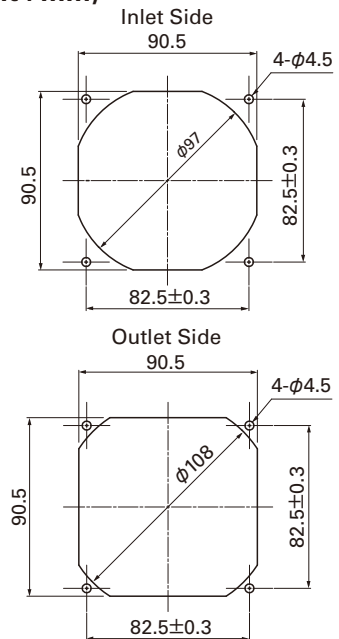

- The products shown in this catalog are subject to Japanese Export Control Law. Diversion contrary to the law of exporting country is prohibited.
- To protect against electrolytic corrosion that may occur in locations with strong electromagnetic noise, we provide fans that are unaffected by electrolytic corrosion.

SANYO DENKI CO., LTD. 3-33-1, Minami-Otsuka, Toshima-ku, Tokyo, 170-8451, Japan TEL: +81 3 5927 1020

<http://www.sanyodenki.com>

The names of companies and/or their products specified in this catalog are the trade names, and/or trademarks and/or registered trademarks of such respective companies. "San Ace" is a trademark of SANYO DENKI CO.,LTD.

Specifications are subject to change without notice.

CATALOG No. C1036B001 '14.2