



Crompton Instruments Integra Digital Metering Systems



Integra Digital Metering Systems

The Integra digital metering product portfolio offers an extensive range of systems designed to suit any power monitoring application.

Integra digital metering systems (dms) provide fully programmable, highly accurate measurement, display and communication of all major electrical and power quality parameters, including true rms system values, power quality data and measurement of total harmonic distortion. Designed to meet customer requirements, the Integra digital metering portfolio offers optional pulsed, analogue and digital communication outputs, DIN or ANSI case styles and high quality LED or LCD displays.

Features

- Measurement, display and communication of electrical and power parameters
- High contrast LED or LCD display
- THD measurement and power quality data to 31st harmonic
- True rms and average sensing measurement
- Pulsed, analogue and digital outputs
- Modbus RTU RS485 protocol, Johnson Controls and Lonworks protocol interface options
- Fully programmable VT and CT ratios

Benefits

- Pre-calibrated plug-in options
- Simple menu driven interface
- Remote monitoring
- True three-and four-wire measurement

Applications

- Switchgear
- Distribution systems
- Generator sets
- Control panels
- Energy management
- Utility power monitoring
- Motor monitoring
- Ground power units

Contents

DIN Integra Metering Specification Overview

Integra Ci3 Digital Metering System

Integra Ri3 Digital Metering System

Integra 1630 Digital Metering System

Integra 1530 Digital Metering System

Integra 1540 Digital Metering System

Integra Communication and Configuration Software

Page

3

4 - 5

6 - 7

8 - 11

12 - 15

16 - 18

19

DIN Integra Digital Metering Specification Overview

	Integra Ci3	Integra Ri3	Integra 1630	Integra 1530	Integra 1540
96mm (3.78") x 96mm (3.78")	✓		✓	✓	
Panel cut-out 92mm x 92mm (3.62"x3.62")	✓		✓	✓	
Din-rail mounting		✓			
Dimensions 72 x 91 mm (2.83"x3.58") as per DIN 43880		✓			
110mm (4.31") x 110mm (4.31")					✓
Panel cut-out 103mm diam (4.06") 4 stud positions					✓
IP54 protection	✓		✓	✓	✓
Single-phase system	✓	✓	✓	✓	
Single-phase 3-wire system				✓	
3-phase 3-wire system	✓	✓	✓	✓	✓
3-phase 4-wire system	✓	✓	✓	✓	✓
3-phase 4-wire with neutral CT				✓	
3-line 4-digit LCD display	✓	✓			
Graphical backlit LCD display					
3-line 4-digit LED display			✓	✓	✓
Programmable display			✓	✓	✓
Programmable VT ratios			✓	✓	✓
Programmable CT ratios	✓	✓	✓	✓	✓
Configuration software option	✓	✓	✓	✓	✓
Measured parameters					
Voltage line-to-line	✓	✓	✓	✓	✓
Voltage line-to-neutral (4 wire system)	✓	✓	✓	✓	✓
System voltage	✓	✓	✓	✓	✓
Current L1, L2, L3	✓	✓	✓	✓	✓
System current	✓	✓	✓	✓	✓
Neutral current calculated	✓	✓	✓	✓	✓
Neutral current measured				✓	
Frequency 45-66Hz	✓	✓	✓	✓	✓
Demand current	✓	✓	✓	✓	✓
Max demand current	✓	✓	✓	✓	✓
Demand active power	✓	✓	✓	✓	✓
Max demand active power	✓	✓	✓	✓	✓
Power factor	✓	✓	✓	✓	✓
Active power kW	✓	✓	✓	✓	✓
Reactive power kVAr	✓	✓	✓	✓	✓
Apparent power kVA	✓	✓	✓	✓	✓
kW demand	✓	✓	✓	✓	✓
Active energy kWh import	✓	✓	✓	✓	✓
Reactive energy kVArh import	✓	✓	✓	✓	✓
Active energy kWh export	✓	✓	✓	✓	✓
Reactive energy kVArh export	✓	✓	✓	✓	✓
Voltage % THD average	✓	✓	✓	✓	✓
Voltage % THD L1, L2, L3	✓	✓	✓	✓	✓
Current % THD average	✓	✓	✓	✓	✓
Current % THD L1, L2, L3	✓	✓	✓	✓	✓
Hours run			✓		
Communication options					
Digital RS485 Modbus RTU	✓	✓	✓	✓	✓
BACnet IP			✓		
BACnet MSTP			✓		
Modbus TCP				✓	
Pulsed output	✓	✓	✓	✓	✓
Analogue outputs				✓	
Lonworks protocol				✓	
Johnson Controls Metasys NII			✓	✓	✓
Standards Compliant with					
EN 61326-1	✓	✓	✓	✓	
EN 61010-1	✓	✓	✓	✓	
EN 62053-21	✓	✓			
RoHS Compliant	✓				
Approvals					
UL LISTED, UL 61010B-1, E203000				✓	✓



Integra Ci3 Digital Metering System

The Integra Ci3 meter is an accurate and cost effective solution for measurement and display of all major electrical and power quality parameters with easy programming, mounting and user friendly navigation.

The product features a DIN 96 panel mounted enclosure, backlit LCD display and user programmable CT ratios, all accessible via an intuitive user interface. Integra Ci3 dms measures 17 electrical parameters including total harmonic distortion (THD) measurement up to the 31st harmonic.

Programmable Functions

Integra Ci3 dms is programmable to suit single-phase, three-phase three-wire and three-phase four-wire system configurations. Programmable CT ratios enable to display any current range.

Display

The parameters can be viewed on a backlit LCD display. The 15 screens are accessible via four buttons on the front panel allowing to scroll between various screens making the navigation very user-friendly, intuitive and above all – simple.

Plug-in Modules

Integra Ci3 dms features two output options ports at the rear of the product. This allows to fit either pulsed relay or communication modules, e.g. Modbus RTU RS485 protocol communication output.

Panel Mounting

Integral retention clips allow fast, safe and secure panel mounting in various material thicknesses without the need for external screws or clips.

Dimensions

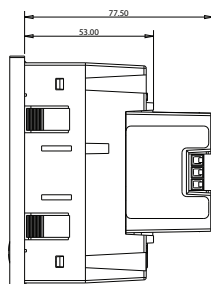
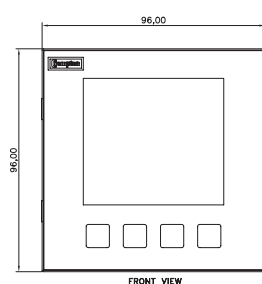

Panel cut-out

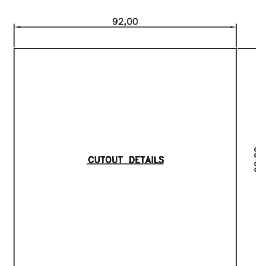

Product Code

Description	Part number
Integra Ci3 base unit	CI3-01
Options	
Pulsed output	CI-PUL-01
Modbus RTU RS485 protocol	CI-MOD-01
Accessories	
IP65 protective cover	3 G365 02
IP54 panel gasket	3 C345 01

Programmable Parameters

Parameter	Range
Password:	4-digit 0000-9999
System configuration:	1-phase 2-wire, 3-phase 3-wire, 3-phase 4-wire
CT primary current:	Maximum 9999A **
Demand integration time:	OFF 5, 8, 10, 15, 20, 30, 60 minutes
3 independent resets:	Demands and maximum demands
Energy registers:	Kilo or mega
Pulse output allocation:	None, kWh or KVARh
Pulse output duration:	60, 100, 200 milliseconds
Pulse rate divisors:	0.1, 1, 10, 100, 1000
RS485 baud rate:	2.4, 4.8, 9.6, 19.2, 38.4 kBd
RS485 parity and stop bits:	Odd or even with 1 stop bit or no parity with 1 or 2 stop bits
Comms Address:	1-247
Floating point:	Normal or Reverse



6.1mm
bezel
depth

Easy
'clip-in'
mounting

Features

- DIN 96 enclosure
- Backlit LCD screen
- Bezel depth 6.1mm
- Plug-in output modules
- Programmable CT ratio
- True rms measurement
- User programmable system configuration

Benefits

- Cost effective
- Intuitive navigation
- Crompton renowned quality
- UK manufactured
- Easy 'clip-in' panel mounting

Standards

- IEC 61326
- IEC 61010-1
- IEC 62053-21
- RoHS compliant



Specifications

Input	
Nominal input voltage	100-289V AC L-N (173-500V AC L-L)
Max. continuous input overload voltage	120% of nominal
Max. short duration voltage	2 x range maximum (1 second application input repeated 5 times at 5 minute intervals)
Nominal input voltage burden	< 0.2VA per phase
Nominal input current	5A AC rms
Max. continuous input overload current	120% of nominal
Max. short duration input current	10 x nominal (1 second application repeated 5 times at 5 minute intervals)
Frequency	45-66Hz
Auxiliary	
Operating range	110-400V AC nominal +/-10% (99-440V AC absolute limits) or 120-350V DC +/-20% (96-420V DC absolute limits)
Accuracy	
Voltage (V)	0.5%
Current (A)	0.5%
Neutral current calculated (A)	4%
Frequency (Hz)	0.1 Hz
Power factor (PF)	1% of unity
Active power (W)	+/- 1% of range
Reactive power (VAr)	+/- 1% of range
Apparent power (VA)	+/- 1% of range
Active energy (kWh)	Class 1 (IEC 62053-21)
Reactive energy (kVArh)	+/- 1% of range
THD	1% up to 31st harmonic
Response time	1 sec
Output modules (optional)	
Pulsed output relays	1 per module (2 modules fitted per Ci3)
Contact rating	50mA max at 250V AC
Type	Solid state relay
Modbus RTU RS485 Protocol output module	1 Modbus RTU RS485 Protocol channel per module (maximum of 1 module fitted per Ci3)
Type	2-wire half duplex
Baud rate	2400, 4800, 9600, 19200, 38400
Enclosure	
Enclosure style	DIN 96 panel mount
Panel cut-out	92x92mm
Panel thickness	1-5mm (1-3mm when used with IP65 cover)
Front protection rating	IP52
Case protection rating	IP30
Material	Polycarbonate to UL94V0
Weight	Ci3, 260g, Modbus 40g, pulsed 20g
Terminals	Shrouded screw-clamp 0.05-4mm wire
Environment	
Operating temperature	-10°C to +55°C
Storage temperature	-20°C to +70°C
Relative humidity	0-90% non-condensing
Shock	30g in 3 planes
Vibration	10Hz to 50Hz
Dielectric voltage	Withstand test 3.25kV rms 50Hz for 1 minute between comms and measuring inputs, comm and aux, aux and measuring inputs

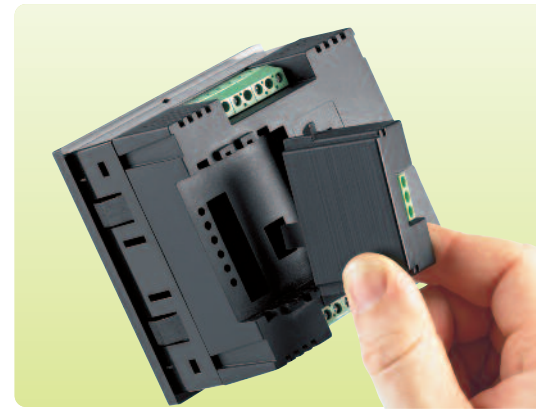

Parameters

Button	Screen	Parameters
V/Hz	1	Volts L1 - N
		Volts L2 - N
		Volts L3 - N
	2	Volts L1 - L2
		Volts L2 - L3
	3	Volts L3 - L1
		Frequency
	4	Volts L1 - N THD%
		Volts L2 - N THD%
	5	Volts L3 - N THD%
Volts L1 - L2 THD%		
Volts L2 - L3 THD%		
A	1	Current L1
		Current L2
		Current L3
	2	Neutral Current
		L1 Current Max Demand
		L2 Current Max Demand
	3	L3 Current Max Demand
		Neutral Current Max Demand
	4	Current L1 THD%
		Current L2 THD%
5	Current L3 THD%	
	P/PF	1
kVAr		
kVA		
2	kW Max Demand	
	3	Power Factor
E	1	kWh
		2

Connection

1-Phase 2-Wire

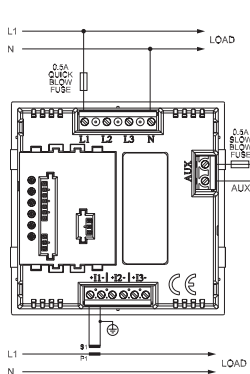

3-Phase 3-Wire

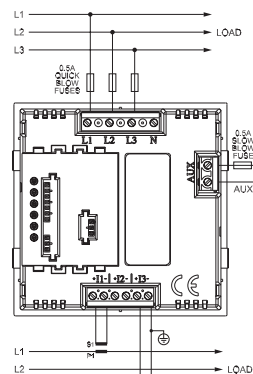

3-Phase 4-Wire

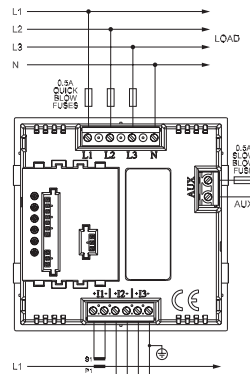

OPTION MODULES (When Fitted)

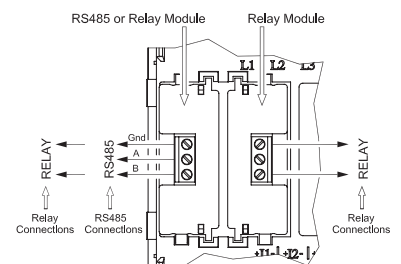

Integra Ri3 Digital Metering System

The Integra Ri3 dms is an accurate and cost effective solution for measurement and display of all major electrical and power quality parameters with easy programming and user friendly navigation in DIN 43880 enclosure.

The product features a DIN-rail enclosure, backlit LCD display and user programmable CT ratios, all accessible via an intuitive user interface. Integra Ri3 dms measures 17 electrical parameters including total harmonic distortion (THD) measurement up to the 31st harmonic.

Programmable Functions

Integra Ci3 dms is programmable to suit single-phase, three-phase three-wire and three-phase four-wire system configurations. Programmable CT ratios enable to display any current range.

Display

The parameters can be viewed on a backlit LCD display. The 15 screens are accessible via four buttons on the front panel allowing to scroll between various screens making the navigation very user-friendly, intuitive and above all – simple.

Output

Modbus RTU RS485 protocol and pulsed output are available as standard.

Dimensions

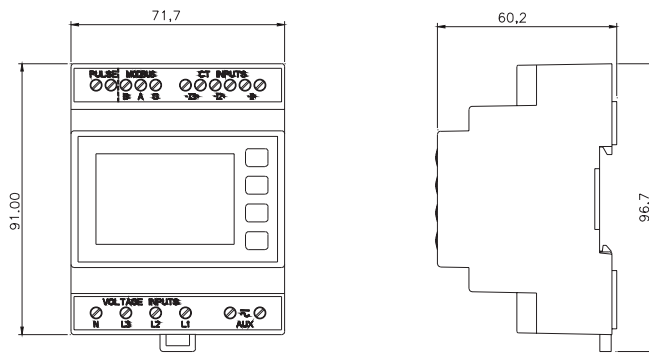

Features

- DIN-rail enclosure DIN 43880
- Backlit LCD screen
- Programmable CT ratio
- True rms measurement
- User programmable system configuration
- Pulsed output and Modbus RTU RS485 protocol as standard

Benefits

- Cost effective
- Simple navigation
- Crompton renowned quality
- UK manufactured

Standards

- IEC 61326
- IEC 61010-1
- IEC 62053-21



Product Codes

Description	Part number
Integra Ri3 dms	RI3-01

Programmable Parameters

Parameter	Range
Password:	4-digit 0000-9999
System configuration:	1-phase 2-wire, 3-phase 3-wire, 3-phase 4-wire
Demand integration time:	OFF 5, 8, 10, 15, 20, 30, 60 minutes
CT primary current:	Maximum 9999A **
3 independent resets:	Demands and maximum demands
Communications:	Modbus RTU RS 485 or JC N2
RS485 baud rate:	2.4, 4.8, 9.6, 19.2, 38.4 kbps
RS485 parity and stop bits:	Odd or even with 1 stop bit or no parity with 1 or 2 stop bits
RS 485 Comms Address:	1-247
Modbus word order:	Normal or reverse
Pulse output allocation:	Import or export kWh or import or export KVARh
Pulse rate, rate per pulse:	0.001, 0.01, 0.1, 1, 10, 100, 1k, 10 k (max 2 pulses per sec)
Pulse output duration:	60, 100, 200 milliseconds
Energy units:	Unit, lilo or mega
Noise limit (1%):	On or off
Test:	Display ON, TOGGLE or PHASE SEQUENCE

Specifications

Input	
Nominal input voltage	100-289V AC L-N (173-500V AC L-L)
Max. continuous input overload voltage	120% of nominal
Max. short duration input voltage	2 x range maximum (1 second application repeated 5 times at 5 minute intervals)
Nominal input voltage burden	< 0.2VA per phase
Nominal input current	5A AC rms
Max. continuous input overload current	120% of nominal
Max. short duration input current	10 x nominal (1 second application repeated 5 times at 5 minute intervals)
Nominal input current burden	< 0.6VA per phase
Frequency	45-66Hz
System CT primary values	1 to 9999
Auxiliary	
Operating range	110-400V AC nominal +/-10% (99-440V AC absolute limits) or 120-350V DC +/-20% (96-420V DC absolute limits)
Burden	< 10VA/5W
Accuracy	
Voltage (V)	0.5%
Current (A)	0.5%
Neutral current calculated (A)	4%
Frequency (Hz)	0.1 Hz
Power factor (PF)	1% of unity
Active power (W)	+/- 1% of range
Reactive power (VAr)	+/- 1% of range
Apparent power (VA)	+/- 1% of range
Active energy (kWh)	Class 1 (IEC 62053-21)
Reactive energy (kVArh)	+/- 1% of range
THD	1% up to 31st harmonic
Response time	1 sec
Output	
Pulse output relay	1
Contact rating	50mA max at 250V AC
Type	Solid state relay
Modbus RTU RS485 protocol output module	1 Modbus RTU RS485 protocol channel
Type	2-wire half duplex
Baud rate	2400, 4800, 9600, 19200, 38400
Enclosure	
Enclosure style	DIN-rail - DIN 43880
Front protection rating	IP52
Case protection rating	IP30
Material	Polycarbonate to UL94V0
Weight	300g
Terminals	Shrouded screw-clamp 0.05-4mm wire
Environment	
Operating temperature	-10°C to +55°C
Storage temperature	-20°C to +70°C
Relative humidity	0-90% non-condensing
Shock	30g in 3 planes
Vibration	10Hz to 50Hz
Dielectric voltage	Withstand test 3.25kV rms 50Hz for 1 minute between comms and measuring inputs, comm and aux, aux and measuring inputs

Parameters

Button	Screen	Parameters
V/Hz	1	Volts L1 - N Volts L2 - N Volts L3 - N
	2	Volts L1 - L2 Volts L2 - L3 Volts L3 - L1
	3	Frequency
	4	Volts L1 - N THD% Volts L2 - N THD% Volts L3 - N THD%
	5	Volts L1 - L2 THD% Volts L2 - L3 THD% Volts L3 - L1 THD%
A	1	Current L1 Current L2 Current L3
	2	Neutral Current
	3	L1 Current Max Demand L2 Current Max Demand L3 Current Max Demand
	4	Neutral Current Max Demand
	5	Current L1 THD% Current L2 THD% Current L3 THD%
P/PF	1	kW kVAr kVA
	2	kW Max Demand
	3	Power Factor
E	1	Import kWh
	2	Export kWh
	3	Import kVArh
	4	Export kVArh

Connection

3-Phase 3-Wire

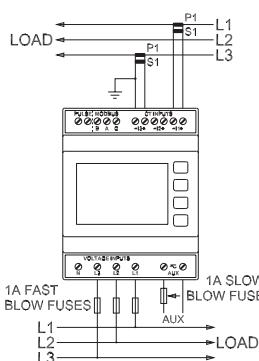

Single-Phase 2-Wire

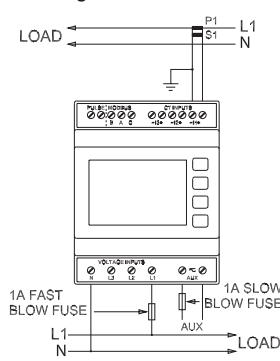

3-Phase 4-Wire

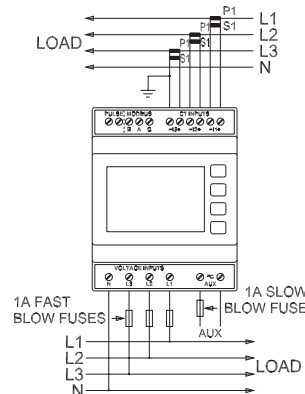

Integra 1630 Digital Metering System



The Integra 1630 digital metering system (dms) provides high accuracy 0.2% measurement, display and communication of all major electrical and power quality parameters including total harmonic distortion (THD) up to the 31st harmonic. To suit user requirements, the range includes single-phase, three-phase three-wire and three-phase four-wire capability, all selectable at the point of installation.

This DIN 96 panel mounting enclosure offers simple programming and display of up to 35 electrical parameters via a simple menu-driven user interface on the front panel. Optional pulsed and digital communication outputs are available, to allow up to 60 parameters to be communicated to building management systems. A Windows-based software package is available to remotely configure the Integra dms and display all 60 major parameters.

Application

- Switchgear distribution systems
- Control panels
- Embedded generation
- Energy management
- Building management
- Utility power monitoring
- Process control
- Motor monitoring

Features

- Low profile
- High contrast LED display
- LED annunciators for each measured parameter
- User programmable system configuration (4-wire default)
- Fully programmable VT and CT ratios
- Current demand per phase
- Elapsed time counter for connected loads
- Removable bezel for very low profile applications

Benefits

- True rms measurement
- High accuracy <0.2% on some measurements
- Configurable via software package or menu-driven interface
- Import and export monitoring

Standards

- IEC1010-1 (BSEN 61010-1 - 2001)

Dimensions

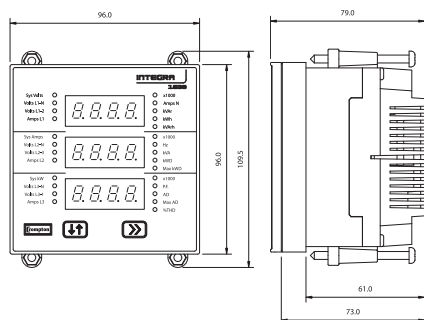

Operation

Integra 1630 dms offers uncomplicated operation and high accuracy measurement of three-phase voltage, current, frequency, Watts, VAR, VA, energy, power factor, and total harmonic distortion of both phase and system, current and voltage. Integra 1630 dms includes true measurement of both line-to-neutral, and line-to-line voltages, ensuring accurate readings. The pre-calibrated plug-in option cards allow cost effective upgrades with any combination of pulsed, analogue and digital communication outputs. Cards slot simply into the back of the unit and products do not need to be removed from the installation or recalibrated.

Pulsed Outputs

Integra 1630 meters offer optional single or dual pulsed outputs, programmable to represent import or export kWh, import or export kVarh or kVAh. The output pulses have programmable pulse rate divisor and pulse width.

Modbus RTU RS485 Protocol

Integra 1630 dms offers an RS485 communication port using the Modbus RTU RS485 protocol or the Johnson Controls Metasys NII protocol. Integra 1630 meter establishes the format for the master's query automatically, and responds with the correct protocol using IEEE floating point values. The Modbus RTU RS485 protocol option also offers user programmable word order and support for function 8 subfunction 0, return query data diagnostic.

Modbus TCP (Ethernet)

Integra 1630 dms options include an Ethernet communication module for connection to SCADA systems using the Modbus TCP protocol. The Integra 1630 dms with Ethernet option module acts as a Modbus slave device and may be queried by a Modbus master device. All messages sent to the Integra Ethernet interface must conform to the Modbus TCP protocol. For details see: http://www.modbus.org/docs/Modbus_Messaging_Implementation_Guide_V1_0b.pdf

BACnet IP Interface

Integra 1630 dms options include an Ethernet communication module for connection to SCADA systems using the BACnet IP protocol. The Integra 1630 dms acts as a server device and waits to receive commands from a BACnet/IP client. A BACnet/IP client (e.g. a SCADA system running on a PC), is used to instigate communication with the meter. All messages sent to the Integra Ethernet interface must conform to the BACnet IP protocol. For details on the protocol see the BACnet organisation website: <http://www.bacnet.org/>

BACnet MSTP Interface

Integra 1630 options include a BACnet MSTP module for connection via RS485 to SCADA or Building Automation and Management systems running BACnet MSTP clients. The Integra 1630 acts as a server device and waits to receive requests from a BACnet client that must conform to the BACnet MSTP Protocol. The module is fitted with a three-way screw terminal block to daisy-chain the BACnet communications cable. Standard RS485 communications cable should be used. Note that with this interface option fitted, there are no other external communication protocols available and pulsed relay outputs are not fitted.

Programmable Display

A two-button interface on the front panel provides configuration programming of system (e.g. three-phase four-wire), VT and CT ratio settings, selected communication options and adjustment of operating parameters. All set-up screens offer password protection. Status information can be viewed by scrolling through 16 screens featuring a high contrast three-line, four-digit LED display, with separate annunciators for each of the 35 measured parameters.

Product Codes

Description	Cat. no.
1-phase, 3-phase 3/4-wire, 100-240V L-L, 5A CT input, Aux. 100-250V AC/DC	INT-1630-L-5-M-option
1-phase, 3-phase 3/4-wire, 241-480V L-L, 5A CT input, Aux. 100-250V AC/DC	INT-1630-M-5-M-option
Options	
No options	000
1 pulsed output	100
2 pulsed outputs	200
Modbus RTU RS485 protocol	010
Modbus RTU RS485 protocol + 1kWhr pulsed output	110
Modbus RTU RS485 protocol + 2kWhr pulsed outputs	210
Modbus RTU RS485 protocol TCP	070
BACnet IP interface	080
BACnet MSTP interface	090
Extended collar	OPT-1630-collar

Programmable Parameters

Parameter	Range
Password:	4-digit 0000-9999
CT primary current:	Maximum 9999A ** CT Secondary Current: 5A (1A option)
VT primary voltage:	Maximum 400kV **
VT secondary voltage:	Nominal input voltage ** maximum VT or CT ratios are limited so that the combination of primary voltage and current do not exceed 360MW at 120% of relevant input
Demand integration time:	8, 15, 20, 30, 60 minutes
3 independent resets:	Demands and maximum demands Energy registers Hours run
Pulse output duration:	60, 100, 200 milliseconds
Pulse rate divisors:	1, 10, 100, 1000
RS485 baud rate:	4.8, 9.6, 19.2, 38.4 kBd
RS485 parity and stop bits:	Odd or even with 1 stop bit or no parity with 1 or 2 stop bits

Specifications

Nominal input voltage:	57.7 to 277V L-N, 100 to 480V L-L
Max. continuous input voltage:	120% nominal
Max. short duration input voltage:	2 x nominal for 1 second, repeated 10 times at 10 second intervals
System VT ratios (primary):	Any significant 4-digit integer value up to 400kV **
Nominal input voltage burden:	< 0.2 VA
Nominal input current:	5A (1A option)
System CT primary values:	Any integer value up to 9999A **
Max. continuous input current:	120% nominal
Max. short duration input current:	20 x nominal for 1 second, repeated 5 times at 5 minute intervals
Nominal input current burden:	< 0.6 VA ** maximum CT and VT ratios are limited so that the combination of primary voltage and current do not exceed 360MW at 120% of relevant input

Measurement and Display

Up to 35 electrical and power quality parameters can be configured and displayed.

- System (average) volts
System (average) current
System (total) kW
- System volts (average) THD%
System current (average) THD%
- Volts L1 - N
Volts L2 - N
Volts L3 - N
(4-wire only)
Volts L1 - L2
Volts L2 - L3
Volts L3 - L1
(3-wire only)
- Volts L1 - N THD%
Volts L2 - N THD%
Volts L3 - N THD%
(4-wire only)
Volts L1 - L2 THD%
Volts L2 - L3 THD%
Volts L3 - L1 THD%
(3-wire only)
- Volts L1 - L2
Volts L2 - L3
Volts L3 - L1
(4-wire only)
- Current L1
Current L2
Current L3
- Current line 1 THD %
Current line 2 THD %
Current line 3 THD %
- Neutral current
(4-wire only)
Frequency
Power factor (overall)
- kVAr kVA kW
- kW Hr import (7-digit resolution)
- kVArh import (7-digit resolution)
- kW Hr export (7-digit resolution)
- kVArh export (7-digit resolution)
- kW demand
Current demand
- Maximum kW demand Maximum current demand
- Hours run

Panel cut-out

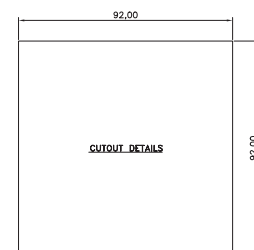



Specifications continued

Output modules (optional)

RS485 communications:	2-wire half duplex
Baud rates:	4800, 9600, 19200, 38400
Pulsed:	Solid state relays
Pulse duration:	60, 100 or 200 milliseconds
Contact rating:	50mA max at 250V AC max
Pulsed outputs:	1 or 2

Auxiliary

Standard nominal supply:	100-250V AC or DC voltage: (85-287V AC absolute limits) (85-312V DC absolute limits)
AC supply frequency range:	45-66Hz
AC supply burden:	6VA
Optional auxiliary DC supply:	12-48V DC (10.2-60V DC absolute limits)
DC supply burden:	6VA

Measuring ranges

Voltage:	80-120% of nominal (functional 5-120%)
Current:	5-120% of nominal
Frequency:	45-66Hz
Power factor:	0.8 capacitive-1-0.8 inductive (functional 4 quadrant, 0-1 lag/lead)
THD:	Up to 31st harmonic 0-40% Measured voltage >5% of range Measured current >5% of nominal Full accuracy of voltage >25% of range Full accuracy of current >25% of nominal
Energy:	7-digit resolution

Reference conditions

Ambient temperature:	23 31°C
Input frequency:	50 or 60Hz 32%
Input waveform:	Sinusoidal (distortion factor < 0.005)
Auxiliary supply voltage:	Nominal 31%
Auxiliary supply frequency:	Nominal 31%
AC auxiliary supply waveform:	Sinusoidal (distortion factor < 0.05)
Magnetic field of external origin:	Terrestrial flux

Accuracy

Voltage:	30.17% of range maximum
Current:	30.17% of nominal
Frequency:	0.15% of mid frequency
Active power:	30.2% of range maximum
Power factor:	1% of unity
Reactive power (VAr):	30.5% of range maximum
Apparent power (VA):	30.2% of range maximum
THD:	31%
Neutral current calculated:	30.95% of nominal
Energy:	0.3% of range maximum (Better than class 1) IEC1036 Sect 4.6)
kVAh:	0.6% of range maximum
Temperature coefficient:	Voltage and current typical: 0.013%/°C Watts typical: 0.018%/°C

Specifications continued

Enclosure

Enclosure style:	DIN 96 panel mount
Compliant with:	IEC 1010-1/ BSEN 61010-1 : 2001 CAT III, CE EMC and LVD directives
Material:	Polycarbonate
Terminals:	Shrouded screw-clamp 0.05mm to 4mm wire
Dielectric voltage:	Withstand test 3.25kV rms 50Hz for 1 minute between all electrical circuits
Operating temperature:	-20 to +60°C
Storage temperature:	-30 to +80°C
Relative humidity:	0-90% (non condensing)
Warm-up time:	1 minute
Shock:	30g in 3 planes
Vibration:	10-18Hz, 1.5mm peak-to-peak 18-150Hz @1g
IP protection:	IP54
Dimensions:	96mm wide x 96mm high x 79mm deep (max). Typically <60mm depth behind panel 3.78" wide x 3.78" high x 3.11" deep (max)
Panel cut-out:	92mm x 92mm, 3.62" x 3.62"

Wiring

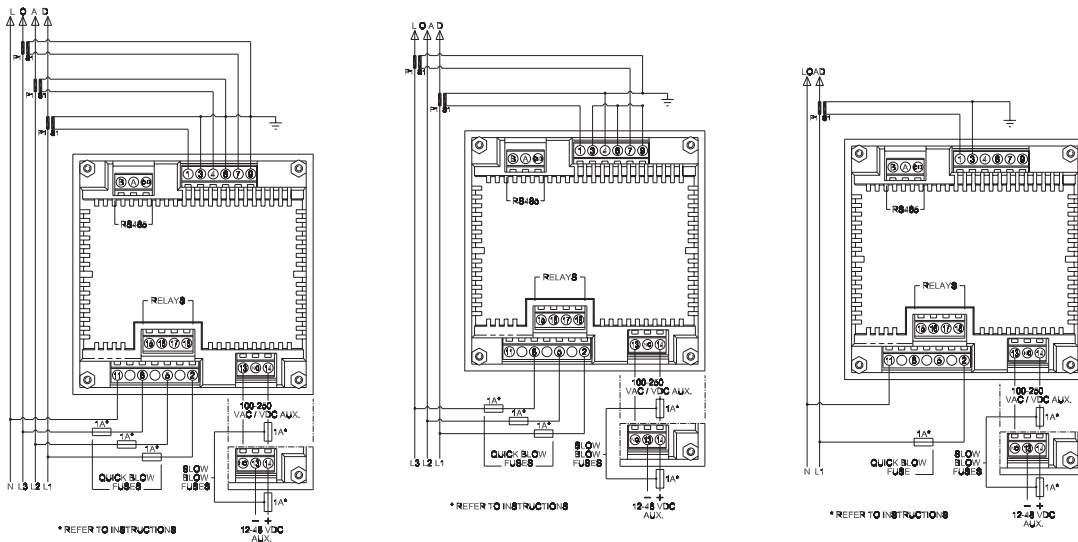

Integra 1530 Digital Metering System

The Integra 1530 series instruments provide high accuracy <0.2% measurement, display and communication of all major electrical and power quality parameters, including true rms system values, and total harmonic distortion (THD) up to the 31st harmonic.

This DIN 96 panel mounting enclosure offers programming and display of up to 34 power measurement parameters. Optional pulsed, analogue and digital communication outputs, allow the communication of information of up to 50 measured parameters into building management systems. A Windows-based software package is available to remotely configure the Integra dms and display all 60 major parameters.



Application

- Switchgear
- Distribution systems
- Control panels
- Embedded generation
- Energy management
- Building management
- Utility power monitoring
- Process control
- Motor monitoring

Features

- Measure and display up to 34 electrical and power parameters
- Measure and communicate up to 50 electrical and power parameters
- High-contrast red LED display
- LED annunciators for each measured parameter
- THD measurement and power quality data to 31st harmonic
- True rms measurement
- Pulsed, analogue and digital outputs
- Modbus, Johnson Controls and Lonworks protocol interface options
- Fully programmable VT and CT ratios

Benefits

- Replaces multiple single function instruments
- Pre-calibrated plug-in options
- High accuracy <0.2%
- Configurable via software package or menu driven interface
- Import and export monitoring
- Neutral CT input option
- True 3-and 4-wire measurement

Standards

- UL file no: E20300
- UL 61010B-1
- IEC 1010-1/BSEN 61010-1 CAT III

Operation

Integra 1530 digital metering system (dms) offers uncomplicated operation and high accuracy measurement of three-phase voltage, current, frequency, Watts, VAR, VA, energy, power factor, and total harmonic distortion of both phase and system, current and voltage. Integra 1530 dms includes true measurement of both line-to-neutral, and line-to-line voltages, ensuring accurate readings.

System Input

Designed for all low, medium and high voltage switchgear and distribution systems, the Integra 1530 meter offers programmable VT and CT ratio capability. Direct connection for up to 480V AC with 5A CT inputs is standard, and 1A CT inputs available as an option.

Neutral CT Input Option

Integra 1530 dms offers a three-phase four-wire version with a neutral 4th CT, allowing true neutral current measurement and protection in high harmonic environments.

System Outputs

Integra dms pre-calibrated plug-in option cards allow cost effective upgrades with combinations of pulsed, analogue and digital communication outputs. Cards slot simply into the back of the unit and products do not need to be removed from the installation or recalibrated.

Modbus RTU RS485

Integra 1530 meter offers a communication port for systems using Modbus RTU or Johnson Controls Metasys NII protocols. Modbus communications can be used together with pulse and analogue output options.

Lonworks Protocol Interface

The Lonworks protocol interface option is designed according to the LonMark Interoperability Guidelines version 3.2. This ensures Integra meters can be integrated into a single control network without requiring custom node or network tool development.

Programmable Display

A two-button interface on the front panel provides configuration programming of system (three-phase four-wire etc), VT and CT ratio settings, selected communication options and adjustment of operating parameters. All set-up screens offer password protection. Status information can be viewed by scrolling through 15 screens featuring a high contrast three-line, four-digit LED display, with separate annunciators for each of the 34 measured parameters.

Product Codes

Description	Cat. no.
1-phase 2-wire 100-240V L-L, 5A CT input. Aux. 100-250V AC/DC	INT-1531-L-5-M-option
1-phase 2-wire 241-480V L-L, 5A CT input. Aux. 100-250V AC/DC	INT-1531-M-5-M-option
1-phase 3-wire 100-240V L-L, 5A CT input. Aux. 100-250V AC/DC	INT-1532-L-5-M-option
1-phase 3-wire 241-480V L-L, 5A CT input. Aux. 100-250V AC/DC	INT-1532-M-5-M-option
3-phase 3-wire 100-240V L-L, 5A CT input. Aux. 100-250V AC/DC	INT-1533-L-5-M-option
3-phase 3-wire 241-480V L-L, 5A CT input. Aux. 100-250V AC/DC	INT-1533-M-5-M-option
3-phase 4-wire 100-240V L-L, 5A CT input. Aux. 100-250V AC/DC	INT-1534-L-5-M-option
3-phase 4-wire 241-480V L-L, 5A CT input. Aux. 100-250V AC/DC	INT-1534-M-5-M-option
3-phase 4-wire with true neutral measurement 100-240V L-L, 5A CT input, Aux 100-250V AC/DC	INT-1535-L-5-M-option
3-phase 4-wire with true neutral measurement 241-480V L-L, 5A CT input, Aux 100-250V AC/DC	INT-1535-M-5-M-option
Options	
Lonworks protocol	030
1 analogue output (0/20mA)	001=1
2 analogue outputs (0/20mA)	002=1

Programmable Parameters

Parameter	Range
Password:	4-digit, 0000-9999
Primary current:	Max 9999:5A (360MW max**)
VT primary:	400kV (360MW max**)
Secondary voltage:	Nominal system voltage ** maximum VT and CT ratios are limited so that the combination of primary voltage and current does not exceed 360MW at 120% of relevant input
Demand integration time:	8, 15, 20, 30 and 60 minutes
Reset:	Max demand and active energy registers
Pulse output duration:	60, 100, 200 ms
Pulse rate divisors:	1, 10, 100, 1000
RS485 interface baud rate:	2.4, 4.8, 9.6, 19.2kB
RS485 parity:	Odd/even/no, 1 or 2 stop bits
Modbus RTU RS485 protocol address:	1-247
Analogue outputs:	User definable



Measurement and Display

Up to 34 electrical and power quality parameters can be configured and displayed on the Integra 1530 dms unit.

- 1 System volts
System current
System kW
- 2 System volts THD %
System current THD %
- 3 Volts L1 - N (4-wire only)
Volts L2 - N (4-wire only)
Volts L3 - N (4-wire only)
- 4 Volts L1 - L2
Volts L2 - L3
Volts L3 - L1
- 5 Volts line 1 THD %
Volts line 2 THD %
Volts line 3 THD %
- 6 Current L1
Current L2
Current L3
- 7 Current line 1 THD %
Current line 2 THD %
Current line 3 THD %
- 8 Neutral current (4-wire only)
Frequency
Power factor
- 9 kVAr
kVA
kW
- 10 kWh import (7-digit resolution)
- 11 kVArh import (7-digit resolution)
- 12 kWh export (7-digit resolution)
- 13 kVArh export (7-digit resolution)
- 14 kW demand
Current demand
- 15 kW maximum demand
Current maximum demand

Enhanced status information of up to 50 parameters can be communicated into building management systems via optional pulsed, analogue and digital outputs.

Dimensions

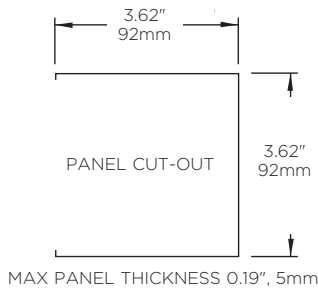
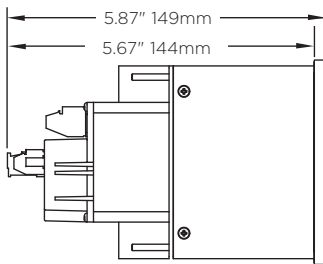
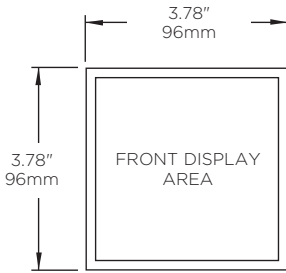

Specifications

Nominal input voltage:	57.7 to 277V L-N, 100 to 480V L-L
Max continuous input voltage:	120% of nominal
Max short duration input voltage:	2 x for 1 second, repeated 10 times at 10 second intervals
System VT ratios (primary):	Any value up to 400kV **
Nominal input voltage burden:	< 0.2 VA
Nominal input current:	5A (1A option)
System CT primary values:	9999:5A or 9999:1A max 360MW **
Max continuous input current:	120% nominal
Max short duration current input:	20 x for 1 second, repeated 5 times at 5 second intervals
Nominal input current burden:	< 0.6 VA
** maximum VT and CT ratios are limited so the combination of primary voltage and current does not exceed 360MW at 120% of relevant input	
Outputs (optional)	
RS485 communications:	2-wire half duplex
Baud rates:	2400, 4800, 9600, 19200
Pulsed:	Clean contact SPNO
Pulse duration:	60, 100 or 200 milliseconds
Pulsed outputs:	1 or 2
Analogue outputs:	1 or 2
Auxiliary	
Standard nominal supply voltage:	100-250V, AC or DC (85-287V, AC absolute) (85-312V, DC absolute)
AC supply frequency range:	45-66Hz
AC supply burden:	6VA
Optional auxiliary DC supply:	12-48V, DC (10.2-60V, DC absolute)
DC supply burden:	6 VA
Measuring ranges	
Voltage:	80-120% of nominal (functional 5-120%)
Current:	5-120% of nominal
Frequency:	45-66Hz
Power factor:	0.8 capacitive - 1 - 0.8 inductive (functional 4 quadrant, 0-1 lag/lead)
THD:	Up to 31st harmonic (0%-40%)
Energy:	7-digit resolution
Reference conditions	
Ambient temperature:	23°-31°C
Input frequency:	50 or 60Hz 32%
Input waveform:	Sinusoidal (distortion factor < 0.005)
Auxiliary supply voltage:	Nominal 31%
Auxiliary supply frequency:	Nominal 31%
AC auxiliary supply waveform:	Sinusoidal (distortion factor < 0.05)
Magnetic field of origin:	Terrestrial flux
Accuracy	
Voltage:	30.17% of range maximum
Current:	30.17% of nominal
Frequency:	0.15% of mid frequency
Active power:	30.2% of range maximum
Power factor:	1% of unity
Reactive power (VAR):	30.5% of range maximum
Apparent power (VA):	30.2% of range maximum
THD:	31%
Neutral current calculated:	30.95% of nominal
Neutral current measured:	30.17%
Energy:	0.3% or range maximum (Better than class 1 IEC1036 Sect 4.6)
KVArh:	0.6% of range maximum
Temperature coefficient:	Voltage & current typical: 0.013%/°C
Watts typical:	0.018%/°C
Update time:	Display: 1 second. Optional digital port: 250ms
Analogue output:	30.2%

Specifications continued

Enclosure

Enclosure style:	DIN 96 panel mount
Compliant with:	UL E20300, UL61010B-1, IEC 1010-1/ BSEN 61010-1 CATIII, EMC and LVD
Material:	Polycarbonate
Terminals:	Shrouded screw-clamp
Dielectric voltage:	Withstand test 3.25kV rms 50Hz for 1 minute between all electrical circuits
Operating temperature:	-20 to +60°C
Storage temperature:	-30 to +80°C
Relative humidity:	0-90% (non condensing)
Warm-up time:	1 minute
Shock:	30g in 3 planes
Vibration:	10-15Hz, 1.5mm peak-to-peak/15-150Hz @ 1g IP protection: IP54
Dimensions:	96mm wide x 96mm high x 149mm deep (max) 3.78" wide x 3.78" high x 5.87" deep (max)
Panel cut-out:	92mm x 92mm, 3.62" x 3.62"

Connections

Single-phase

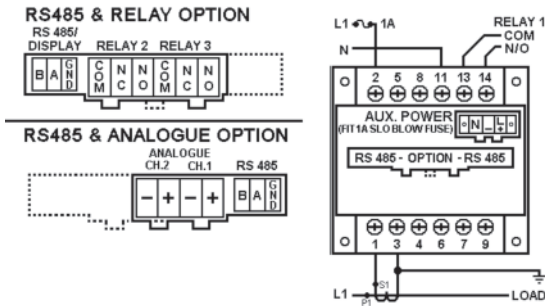

Single-phase 3-wire

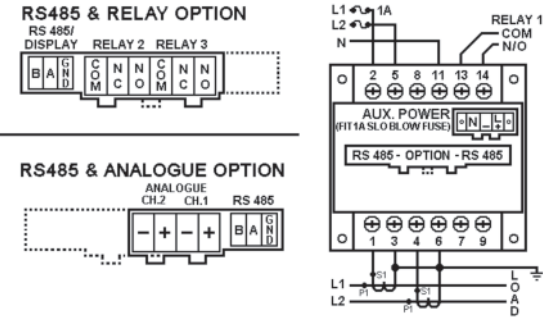

3-phase 3-wire

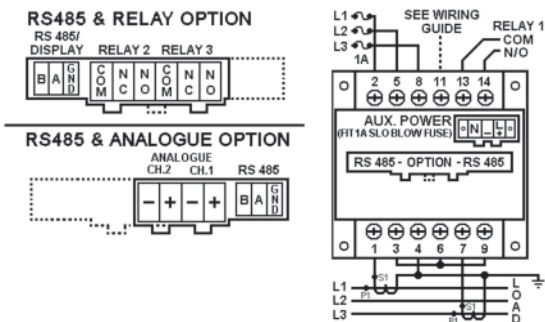

3-phase 4-wire

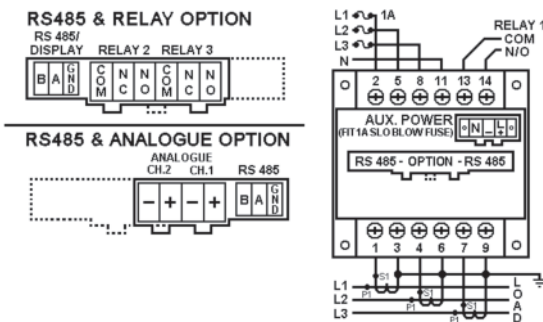

3-phase 4-wire with neutral CT

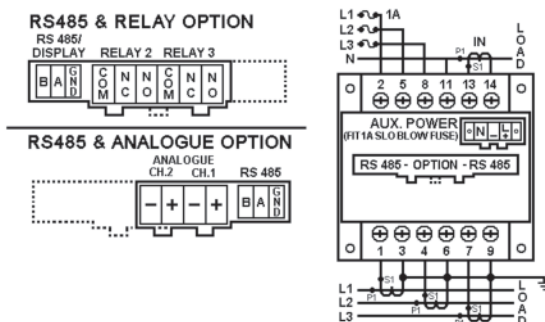

Product Codes continued

Product code	Product configuration
Auxiliary voltage suffix*	
L	12-48V DC
M	100-250V AC/DC
Communications options	
M	RS485 Modbus RTU or Johnson Controls Metasys NII
W	kWh pulsed output

Order Code Example

INT-1544-120-5-L-W

Integra 1540 dms 3-phase 4-wire, 120V L-L (69.3 L-N) nominal voltage, 5A CT input, 12-48V DC auxiliary supply, with pulsed output option.

Programmable Parameters

Parameter	Range
Password	4-digit 0000-9999
Primary current	Max 9999:5 (360MW max**)
VT primary	400kV (360MW max**) ** maximum VT or CT ratios are limited so that the combination of primary voltage and current does not exceed 360MW at 120% of relevant inputs
Demand integration time	8, 15, 20, 30 minutes
Reset	Max demand and active energy registers
Pulse output duration	60, 100, 200 milliseconds
Pulse rate divisors	1, 10, 100, 1000
RS 485 interface baud rate	2.4, 4.8, 9.6, 19.2 kB
RS 485 parity	Odd/even/no. 1 or 2 stop bits
Modbus address	1-247

Specifications

Nominal input voltage:	57.7 to 346V L-N, 100 to 600V L-L
Max continuous input voltage:	120% nominal
Max short duration input voltage:	2 x for 1 second, repeated 10 times at 10 second intervals
System VT ratios (primary):	400kV or 360MW **
Nominal input voltage burden:	< 0.2VA
Nominal input current:	5A (1A option)
System CT primary values:	9999:5A or 9999:1A max 360MW **
Max continuous input current:	120% nominal
Max short duration current input:	20 x for 1 second, repeated 5 times at 5 second intervals
Nominal input current burden:	< 0.6VA
Outputs	
RS485 communications:	2-wire half duplex
Baud rates:	2400, 4800, 9600, 19200
Pulsed:	Clean contact SPNO, 100V DC 0.5A max
Pulse duration:	60, 100 or 200 milliseconds
Auxiliary	
Standard nominal supply voltage:	100-250V AC or DC (85-287V AC absolute) (85-312V DC absolute)
AC supply frequency range:	45-66Hz
AC supply burden:	6VA
Optional auxiliary DC supply:	12-48V DC (10.2-60V DC absolute)
DC supply burden:	6VA

Measurement, Display and Communication

Integra 1540 dms offers configuration, display and communication of up to 31 electrical and power quality parameters.

- System volts
System current
System kW
- System volts THD %
System current THD %
- Volts L1 - N
Volts L2 - N
Volts L3 - N
- Volts L1 - L2
Volts L2 - L3
Volts L3 - L1
- Volts line 1 THD %
Volts line 2 THD %
Volts line 3 THD %
- Current L1
Current L2
Current L3
- Current line 1 THD %
Current line 2 THD %
Current line 3 THD %
- Neutral current
Frequency
Power factor
- kVAr
kVA
kW
- kWh (7-digit resolution)
- kVArh (7-digit resolution)
- kW demand
Current demand
- kW maximum demand
Current maximum demand

Dimensions

RS485 OUTPUT			PULSED OUTPUT	
B	A	Gnd	COM	N/O

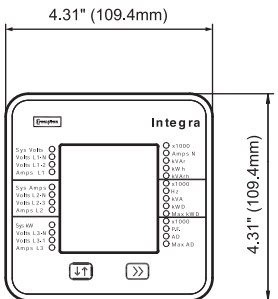
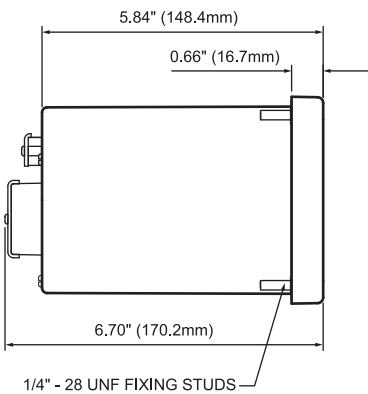
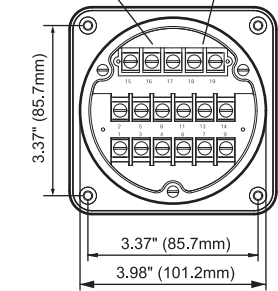

Panel cut-out

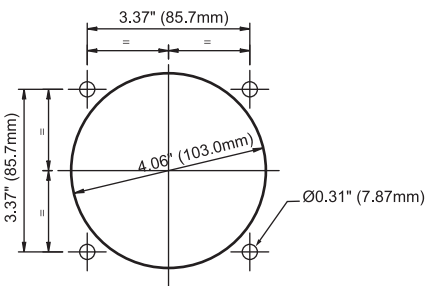

Specifications continued

Measuring ranges

Voltage:	50-120% of nominal (functional 5-120%)
Current:	5-120% of nominal (50%-120% for THD)
Frequency:	45-66Hz
Power factor:	0.5 inductive - 1 - 0.8 capacitive
THD:	To 15th Harmonic V & A
Energy:	7-digit resolution

Accuracy

Voltage:	30.1% of range 30.4% of reading
Current:	30.1% of range 30.4% of reading
Power:	30.1% of range 30.9% of reading
THD:	31%
Neutral current:	34% of range
Energy:	kWh 1% IEC1036 (PF 0.8-1-0.8)
KVArh:	2% IEC1036 (PF 0.8-1-0.8)
Temperature coefficient:	0.013%/°C typical
Update time:	500ms display 250ms optional digital port

Enclosure

Enclosure style:	ANSI C39.1
Compliant With:	UL 140758 and IEC 1010/BSEN 61010-1
Material:	Polycarbonate front and base, steel case
Terminals:	Barrier terminal strip 6-32 binding head screw

Dielectric voltage: Withstand test 3.25kV rms 50Hz for 1 minute between all electrical circuits

Operating temperature:	-20 to +70°C
Storage temperature:	-30 to +80°C
Relative humidity:	0-95% (non condensing)
Warm-up time:	1 minute
Shock:	30g in 3 planes
Vibration:	10-15Hz, 1.5mm peak to peak/15-150Hz@1g
Enclosure integrity:	IP54 (front face)
Dimensions:	4.31" high x 4.31" wide x 6.7" deep 109.4mm high x 109.4mm wide x 170.2mm deep

Panel cut-out: 4.06" (103mm) diameter, 4 stud positions

Wiring

Input connections are made to screw-clamp terminals. Terminals for both current and voltage connections are sized to accept two #12 AWG (3mm²) solid or stranded wires, or ring lugs suitable for 6-32 screws. Connections for communications and pulse outputs use identical style terminals.

Wiring

3-phase 3-wire

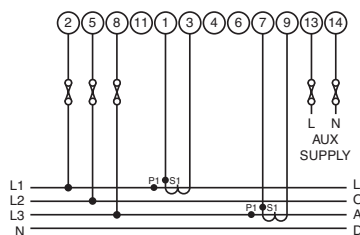

3-phase 4-wire

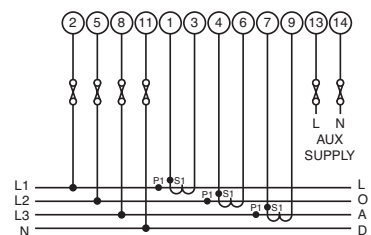

INTEGRA Communication and Configuration Software

INTEGRA software is a Windows style user interface enabling remote monitoring and configuration of Integra dms parameters, outputs, digital communications, pulsed relays, current and power demand. The software can be installed on any PC running Windows. The software allows the user to load and save configurations to a PC hard disk and to send and retrieve settings directly from the Integra dms. Settings can also be copied between individual Integra dms units. Up to 31 Integra dms units can be connected to a PC COM port via an RS485/RS232 converter, however, the software can only communicate with one Integra dms at a time. Status information of measured parameters is usually communicated into a building management system, but can also be monitored through the configuration software. The software queries the selected Integra dms every few seconds to obtain data which can be viewed on a dedicated measurements page.

Password Security

Access to Integra dms programmable parameters is password protected, however, settings and the electrical measurements can be viewed without entering the password. The access passwords entered on the PC must be identical to those stored inside the Integra dms.

Operation

The software is designed to provide two functions: to display and configure the parameters of an Integra dms unit, and to monitor the measured values of the selected Integra dms. The software is extremely simple to operate, featuring user-friendly navigation toolbars and drop-down menus.

Options

There are available three versions of INTEGRA dms software for download from our website.

http://crompton-instruments.com/integra_sw_d.html

- INT-SOFT - Version 1.0.19 for Integra 1530 and Integra 1560/1580 dms
- Integra 1630 dms Configurator V 1.0.0 for Integra 1630 dms
- Integra Ci3 dms Configurator v1.0.10 for Integra Ci3 dms

INTEGRA dms software can be downloaded from www.crompton-instruments.com/integra_sw_d.html



Features

- Remote metering
- Remote status information
- PC configuration of programmable parameters
- Full access to each and every parameter
- Upload and download Integra dms settings
- View and edit Integra dms settings
- Load and save parameter settings
- Print data logs
- Password protected

Applications

- PC based communication systems
- SCADA Systems
- PLC interfacing
- Energy management systems

INT-SOFT window	Menu
Measurements:	Displays all measurement values
System window:	System type, volts, current, max system power, secondary volts, nominal volts, firmware version, special product code
Password:	Existing password, new password, confirm password, change password
Energy and demands:	Demand period, demand interval, reset demands, pulse rate divisor, pulse width, reset energy
Analogue outputs:	Set-up of phase readings, output modes, operating mode, trim controls, output of power factor parameters
Digital communications:	Baud rate, parity, stop bits and unique address
Read/write register:	Display and modification of Modbus registers
Configuration toolbar	Description
New configuration:	Create new Integra dms configuration
Open configuration file:	Load an existing configuration from a disk file
Save configuration file:	Save the current configuration to a disk file
Print configuration:	Send the current configuration to a printer
Online:	Connect to the selected Integra dms
Offline:	Disconnect from the selected Integra dms
Upload configuration:	Upload the configuration from the selected Integra dms
Download configuration:	Send current configuration to the selected Integra dms
Configure PC communications:	Enables setting of PC communications

TE DataX Software

TE dataX software is an application for data collection, storage, real time data analytics and reporting of metered energy data. This provides an accurate insight into facility's energy consumption and enables to take proactive cost savings actions.

Software is available from www.crompton-instruments.com



About TE Connectivity

TE Connectivity is a global, \$14 billion company that designs and manufactures over 500,000 products that connect and protect the flow of power and data inside the products that touch every aspect of our lives. Our nearly 100,000 employees partner with customers in virtually every industry – from consumer electronics, energy and healthcare, to automotive, aerospace and communication networks – enabling smarter, faster, better technologies to connect products to possibilities.

While TE Connectivity (TE) has made every reasonable effort to ensure the accuracy of the information in this catalogue, TE does not guarantee that it is error-free, nor does TE make any other representation, warranty or guarantee that the information is accurate, correct, reliable or current. TE reserves the right to make any adjustments to the information contained herein at any time without notice. TE expressly disclaims all implied warranties regarding the information contained herein, including, but not limited to, any implied warranties of merchantability or fitness for a particular purpose. The dimensions in this catalogue are for reference purposes only and are subject to change without notice. Specifications are subject to change without notice. Consult TE for the latest dimensions and design specifications. TE Connectivity and TE connectivity (logo) are trademarks. CROMPTON is a trademarks of Crompton Parkinson Limited and is used under licence. Other products or company names mentioned herein may be trademarks of their respective owners.

TE Energy – innovative and economical solutions for the electrical power industry: cable accessories, connectors & fittings, insulators & insulation, surge arresters, switching equipment, street lighting, power measurement and control.

Tyco Electronics UK Ltd
TE Energy
Freebournes Road
Witham, Essex CM8 3AH

Registered office:
Faraday Road, Dorcan
Swindon, SN3 5HH
Reg. no. 550 926

Phone: +44 (0)870 870 7500
Fax: +44 (0)870 240 5287
Email: crompton.info@te.com

www.crompton-instruments.com
<http://energy.te.com>

