

Amphenol
SINESYSTEMS

RT360™

Circular Connectors



INTERCONNECTING YOUR WORLD

We are Amphenol Sine Systems.

We are a global leader in providing you with interconnection options and solutions.

We fulfill the needs of Industrial, Factory Automation, Heavy Duty and Custom-design markets.

Amphenol Sine Systems, with its 42 year history, 325+ employees worldwide and 3 global facilities, draws on the extensive worldwide resources of Amphenol Corporation to find solutions for our customers. Our engineers design innovative combinations of industry standard connectors and application specific shielding components to create assembly systems that set the standards for performance, reliability, and cost effectiveness. Our engineering, materials, and manufacturing organizations meet the high standards imposed by ISO 9001 as well as many customer specific quality systems. Our performance has earned us ship to stock and world class performance awards from many major OEMs.



Amphenol Sine Systems is a division of **Amphenol Corporation** (www.amphenol.com), one of the largest interconnect solution suppliers in the world. Amphenol Corporation supplies a wide range of product solutions worldwide. Amphenol Corporation, and all its subsidiaries, design, manufacture and market electrical, electronic and fiber-optic connectors, interconnect systems and coaxial and specialty cable. Amphenol has a diversified presence in high growth markets including: Information Technology and Data Communications Equipment, Mobile Devices, Mobile Networks, Broadband Communication, Military and Commercial Aerospace, Industrial and Automotive.

Table of Contents

Description.....	1
Features & Benefits.....	1
Part Ordering Guide - RT/RTOW & RTHP Series Plugs and Receptacles	2
Part Ordering Guide - RT/RTOW Series Machined Contacts	3
Part Ordering Guide - RT/RTOW Series Stamped & Formed Contacts	4
Radsok® Technical Information	5
Part Ordering Guide - RTHP Series Machined Contacts.....	6
RTHP Series Typical Product Picture and Installation Dimension.....	6
Insert Configurations	7
Box and Wall Mounts	8
Straight Plugs	8
Jam Nut Receptacle	9
Cord Grips.....	9
Metal Cable Clamp Cord Grip	10
Wall Mounted Receptacle for Flat Hole Tail	11
Straight Cable Plug with Cord Grip Solution.....	11
Straight Cable Plug with End Cap	12
Straight Cable Plug with 90° Cord Grip Solution	12
Accessories & Tooling -	
Dust Caps.....	13
Sealing Plugs.....	13
Universal Hand Crimp Tool.....	13
Stamp Contact Tool	13
Contact Extraction Tool	13
Crimp Die	14
Pneumatic Crimp Tool.....	14
Gaskets.....	14
Worldwide Company Locations	Back Cover

© 2012 Amphenol Sine Systems Corporation. Every effort has been made to ensure that the information contained in this catalog is accurate at the time of publication. Specifications or information stated in this publication are subject to change without notice. Revised 01/2012

Description

RT360™ industrial circular connectors are multiway connector available in 6 shell sizes and 22 insert arrangements with a variety of wire gauge options. RT360 industrial circular connectors were designed to be intermateable with other industrial connector families.

TECHNICAL DATA	RT Series	RTOW Series	RTHP Series
Temperature Range	-40°C to +105°C or 125°C		-40°C to +125°C
Protection	IP67, IP68		IP67, IP68
DATA - ACCORDING TO UL 840	RT Series	RTOW Series	RTHP Series
Degree of Protection	3		
Over Voltage Category	III		
MATERIALS	RT Series	RTOW Series	RTHP Series
Housing Body	Zinc alloy, Die-cast		
Coupling Nut	Aluminum alloy, Nickel-plated		
Insulation Inserts	Thermosplastic, UL 94 / V0		
Contacts	Brass, Gold-plated		
Seals	Silicone		
ELECTRICAL DATA	RT Series	RTOW Series	RTHP Series
Max. Current (Max. Wire Gauge)	Max. 40A	Max. 7.5A	Max. 455A
Maximum Voltage	300V AC/DC	150V AC/DC	630V AC/DC
Contact Resistance	< 6 mΩ	< 15 mΩ	< 1 mΩ
Test Voltage (Between Contacts)	2000V	1500V	6000V
Minimum Mating Cycles	> 200		
Salt Spray Resistance	48,96h (customized 200,500h)		
Shielded	Cord Grip		



RT Series



RTOW Series



RTHP Series

RT Series

- 6 shell sizes and 11 insert configurations
- Offer standard insert arrangements from 4-28 contacts, mixed Power and Signal arrangements
- Operating voltage of 300V
- Current rating: 13A(signal contacts)
- Alternate keying positions available
- Plastic inserts with flammability rating of UL94-V0
- RoHS compliant

RTOW Series

- 6 shell sizes and 5 insert configurations
- Mating with MIL-C-24682 series connectors
- High density arrangements from 6-32 contacts
- Operating voltage of 150V
- Current rating of 7.5A with machined contacts and 5A with stamped and formed contacts
- Alternate keying positions available
- Plastic inserts with flammability rating of UL94-V0
- RoHS compliant

RTHP Series

- 4 shell sizes and 5 insert configurations
- Single pole High Power arrangements
- 3.6mm-10mm contact sizes
- Operating voltage of 630V
- Current rating: 56A-455A (see page 5)
- Plastic inserts with flammability rating of UL94-V0
- RoHS compliant

Part Ordering Guide - RT/RTOW & RTHP Series Plugs & Receptacles

SERIES	SHELL TYPE	SHELL SIZE	INSERT ARRANGEMENT	TYPE OF CONTACTS	INSERT POLARIZATION	APPLICATION	PLATING	DESIGN VARIATION
*	*	*	*	*	*	*	*	*

RT/RTOW SERIES

SERIES

- RT
- RTOW

SHELL TYPE

- 0: Wall mount recep.
- 6: Cable plug
- 7: Jam nut recep. / rear panel mount

SHELL SIZE

- 10, 12, 14, 16, 18, 20

INSERT ARRANGEMENT

- See Page 7

TYPE OF CONTACTS

- P: Pin contacts
- S: Socket contacts

INSERT POLARIZATION (See Detail below)

- N: Standard version
- W, X, Y, Z: Custom orientation

APPLICATION

- Blank: Standard version (no o-ring)
- H: Standard version, water protection IP67

PLATING

- Blank: Standard is nickel plating (48hr salt spray)
- 1: Black anodized, jam nut (96hr salt spray)
- 2: Black anodized coupling ring (96hr salt spray)

DESIGN VARIATION

- EC: Standard version for 18-14AWG with end cap
- MM: Reduced seal for 24-20AWG with end cap

RTHP SERIES

SERIES

- RTHP

SHELL TYPE

- 0: Wall mount recep.
- 6: Cable plug
- 7: Jam nut recep. / rear panel mount

SHELL SIZE

- 12, 14, 16, 20

INSERT ARRANGEMENT

- See Page 7

TYPE OF CONTACTS

- P: Pin contacts
- S: Socket contacts

INSERT POLARIZATION

- N: Standard version

APPLICATION

- Blank: Standard version (no o-ring)
- H: Standard version, water protection IP67/69

PLATING

- Blank: Standard is nickel plating (48hr salt spray)
- 1: Black anodized, jam nut (96hr salt spray)
- 2: Black anodized coupling ring (96hr salt spray)

DESIGN VARIATION

- Blank: Standard version
- C: Crimp contact
- EC: Crimp contact with end cap
- FG: Crimp contact with flex grip
- H: Flat hole
- M: Screw tail
- S: Crimp contact with cord grip

Detail

Mating Face View of Pin Inserts

The five positions (W, X, Y, Z and Normal) differ in degree of rotation for various sizes and arrangements.

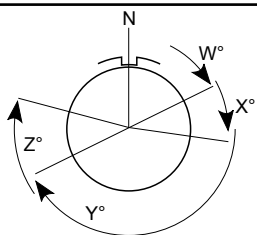

Note: Higher salt spray resistance (200/500h) upon request.

Part Ordering Guide - RT/RTOW Series Machined Contacts

SERIES	WIRE SIZE	CONTACT SIZE	CONTACT PACKAGING	DESIGN VARIATION	GROUNDING CONTACT	PLATING
*	*	*	*	*	*	*

SERIES

- **MP:** Male; **MS:** Female

WIRE SIZE

- **14:** 14AWG (2.5mm); **16:** 18-16AWG (.75-1.5mm); **20:** 22-20AWG (.34-.50mm);
- **24:** 26-24AWG (.14-.25mm); **28:** 30-28AWG (.05-.08mm); **8:** 10-8AWG (6-10mm)

CONTACT SIZE

- **M:** Size 16; **W:** Size 20; **A:** Size 8 Power Contact

CONTACT PACKAGING

- **BP:** Bulk Pack only

DESIGN VARIATION

- **23:** Crimp Barrel; **12E0xx:** PCB tail, for RT00(wall mouting receptacle) **xx** is outer length of PCB tail; **12E7xx:** PCB tail, for RT07(Jam Nut Receptacle) **xx** is outer length of PCB tail; **RS8:** Radsok 3.6mm, crimp barrel

GROUNDING CONTACT

- **GE1:** For Male GND contacts (1 mm longer) add **GE1** to the part number (ex: MP16M23GE1G15); **GE1:** For Female GND contacts (1.5 mm longer) add **GE1** to the p/n (ex: MS16M23GE1G15); **GE7:** For Female Last Mate contacts (0.6 mm shorter) add **GE7** to the part number (ex: MS16M23GE7G15)

PLATING

- **T:** Tin; **F:** Gold Flash; **G:** Gold Plate [Thickness: 10u"]; **G30:** Gold Plate [Thickness: 30u"]; **N:** Nickel; **S:** Plating Silver (5um)



Contact Size	Wire Range		Plating	Male P/N	Female P/N
	AWG	mm			
8	10-8	6-10	Silver	MP10A23S	MS10A23S
16	14	2.5	Silver	MP14M23S	MS14M23S
			Gold Flash	MP14M23F	MS14M23F
			Gold 30u"	MP14M23G30	MS14M23G30
16	18-16	.75-1.5	Silver	MP16M23S	MS16M23S
			Gold Flash	MP16M23F	MS16M23F
			Gold 30u"	MP16M23G30	MS16M23G30
16	22-20	.34-.50	Silver	MP20M23S	MS20M23S
			Gold Flash	MP20M23F	MS20M23F
			Gold 30u"	MP20M23G30	MS20M23G30
16	26-24	.14-.25	Silver	MP24M23S	MS24M23S
			Gold Flash	MP24M23F	MS24M23F
			Gold 30u"	MP24M23G30	MS24M23G30
20	22-20	.34-.50	Silver	MP20W23S	MS20W23S
			Gold Flash	MP20W23F	MS20W23F
			Gold 30u"	MP20W23G30	MS20W23G30
20	30-28	.05-.08	Silver	MP28W23S	MS28W23S
			Gold Flash	MP28W23F	MS28W23F
			Gold 30u"	MP28W23G30	MS28W23G30



RockSolid™
Connections
Hyperbolic Contact
Option

- Longer contact life
- Lower contact resistance
- Immunity to shock and vibration
- Low insertion and extraction forces
- Contact area extends 360° around pins



Part Ordering Guide - RT/RTOW Series Stamped & Formed Contacts

SERIES	WIRE SIZE AWG CRIMP	CONTACT SIZE	CONTACT PACKAGING	DESIGN VARIATION	PLATING
*	*	*	*	*	*

SERIES

- **SP:** Male; **SS:** Female

WIRE SIZE

- **2.5mm:** 2.5mm; **16:** 18-16AWG (.75-1.5mm); **20:** 22-20AWG (.34-.50mm); **24:** 26-24AWG (.14-.25mm); **28:** 30-28AWG (.05-.08mm)

CONTACT SIZE

- **M:** Size 16; **W:** Size 20; **A:** 2.5mm contact

CONTACT PACKAGING

- **Blank:** 3,000 pc reel; **L:** Loose Piece

DESIGN VARIATION

- **1:** Crimp type

PLATING

- **T:** Tin; **F:** Gold Flash; **G:** Gold Plate [Thickness: 10u"]; **G30:** Gold Plate [Thickness: 30u"]; **N:** Nickel; **S:** Silver



Contact Size	Wire Range		Plating	Male P/N	Female P/N
	AWG	mm			
2.5mm	NA	2.5	Tin	SP12A1T	SS12A1T
16	14	2.5	Gold Flash	SP14M1F	SS14M1F
			Gold 10u"	SP14M1G10	SS14M1G10
			Gold 30u"	SP14M1G30	SS14M1G30
16	18-16	.75-1.5	Gold Flash	SP16M1F	SS16M1F
			Gold 10u"	SP16M1G10	SS16M1G10
			Gold 30u"	SP16M1G30	SS16M1G30
16	22-20	.34-.50	Gold Flash	SP20M1F	SS20M1F
			Gold 10u"	SP20M1G10	SS20M1G10
			Gold 30u"	SP20M1G30	SS20M1G30
16	26-24	.14-.25	Gold Flash	SP24M1F	SS24M1F
			Gold 10u"	SP24M1G10	SS24M1G10
			Gold 30u"	SP24M1G30	SS24M1G30
20	22-20	.34-.50	Gold Flash	SP20W1F	SS20W1F
			Gold 10u"	SP20W1G10	SS20W1G10
			Gold 30u"	SP20W1G30	SS20W1G30
20	26-24	.14-.25	Gold Flash	SP24W1F	SS24W1F
			Gold 10u"	SP24W1G10	SS24W1G10
			Gold 30u"	SP24W1G30	SS24W1G30

RADSOK® Technical Information

High Reliability

Unique RADSOK® design and construction technology create an electrical contact interface that exceeds typical interconnect requirements. Applications in Aerospace, Medical, Industrial, Automotive, Mining, Offshore and other harsh environments depend on high reliability of the Amphenol RADSOK® technology.

Low Contact Engagement/Separation Forces

The hyperbolic lamella socket contact construction distributes normal forces over a high percentage of the mating surface. This creates a smooth, even engagement effort. This force distribution also contributes to excellent performance in vibration applications with resistance to typical fretting corrosion.

Low Contact Resistance

The large interface between the socket lamella and pin surface result in very low contact resistance, enabling the RADSOK® contacts' high current ratings compared to traditional power contact designs.

High Mating Cycle Durability

RADSOK® contacts with typical silver plating finishes have demonstrated survival of 20,000 mating cycles. Specialized plating and contact lubricants can extend cycle life to 200,000 mating or higher. Even with continuous exposure to harsh environmental abuse (salt, sand and high humidity), RADSOK® contacts have been tested to maintain low contact resistance beyond 10,000 mating cycles.



RTHP RADSOK®	3.6mm	6mm	8mm	10mm
Current (DIN EN 60512)	115A (23°C) 107A (40°C) 86A (80°C) 56A (120°C)	155A (23°C) 148A (40°C) 116A (80°C) 77A (120°C)	240A (23°C) 235A (40°C) 185A (80°C) 120A (120°C)	455A (23°C) 425A (40°C) 342A (80°C) 222A (120°C)
Contact Resistance	= 0.15mΩ	= 0.11mΩ	= 0.08mΩ	= 0.03mΩ
Mating Force	= 6N	= 12N	= 18N	= 24.8N
m	6.1g	17.5g	32g	55.2g
l	13.2mm	21.9mm	25.7mm	25.7mm
di	3.6mm	6mm	8mm	10mm
da	6mm	9.5mm	13.5mm	15.7mm
Plating	Grid: Silver Sleeve: Silver	Grid: Silver Sleeve: Silver	Grid: Silver Sleeve: Silver	Grid: Silver Sleeve: Silver

Note: The given electrical values correspond to a single contact. With the addition of a housing, an increased number of poles or other modifications, the values must be adjusted downwards accordingly.

Part Ordering Guide - RTHP Series Machined Contacts

SERIES	WIRE SIZE	CONTACT SIZE	CONTACT PACKAGING	DESIGN VARIATION	PLATING
*	*	*	*	*	*

SERIES

- **HP:** Male; **HS:** Female

WIRE SIZE

- **10:** 8-10mm²; **16:** 13-16mm²; **25:** 20-25mm²; **35:** 30-35mm²; **50:** 40-50mm²; **75:** 70-75mm²

CONTACT SIZE

- **A:** 3.6mm; **B:** 6mm; **C:** 8mm; **D:** 10mm

CONTACT PACKAGING

- **BP:** Bulk Pack Only

DESIGN VARIATION

- **C:** Crimp Barrel; **P:** PCB Tail; **S:** Screw Tail; **W:** Soldier Tail; **H:** Flat Hole Tail

PLATING

- **T:** Tin; **F:** Gold Flash; **G:** Gold Plate [Thickness: 10u"]; **G30:** Gold Plate [Thickness: 30u"]; **N:** Nickel; **S:** Plating Silver (5um)



Contact Size	Wire Range	Plating	Male P/N	Female P/N	Type
3.6mm	8-10mm	Silver	HP10ACS	HS10ACS	Crimp
			HP10ASS	HS10ASS	Screwtail
			HP10AHS	HS10AHS	Flathole Tail
6mm	20-25mm	Silver	HP25BCS	HS25BCS	Crimp
			HP25BSS	HS25BSS	Screwtail
			HP25BHS	HS25BHS	Flathole Tail
8mm	30-35mm	Silver	HP35CCS	HS35CCS	Crimp
			HP35CSS	HS35CSS	Screwtail
			HP35CHS	HS35CHS	Flathole Tail
10mm	40-50mm	Silver	HP50DCS	HS50DCS	Crimp
			HP50DSS	HS50DSS	Screwtail
			HP50DHS	HS50DHS	Flathole Tail

Consult Factory for additional Touch Proof options.

Typical Product Picture and Installation Dimension - RTHP Series





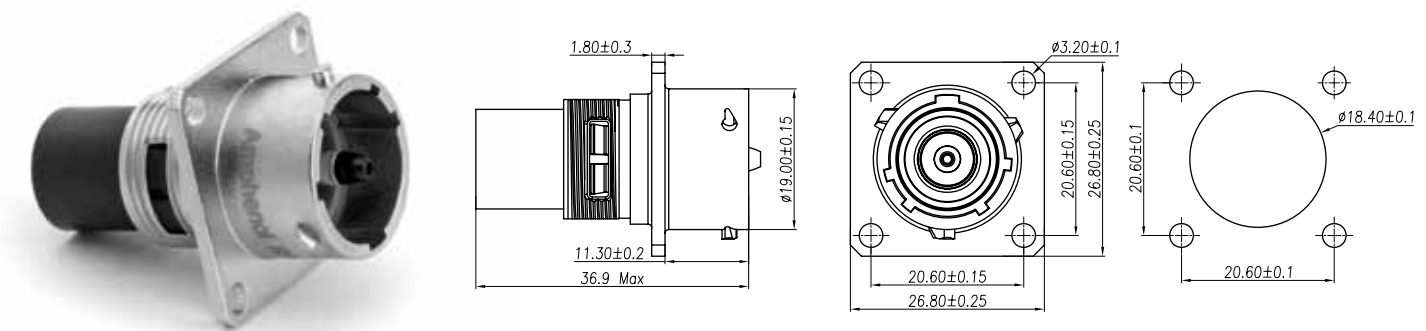

To be used within HV and EV when enduring large current and high voltage

Wall Mounting Receptacle for Crimp Barrel

Part Number: RTHP0121PNH-16C

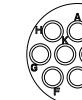
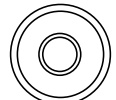
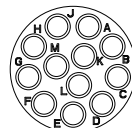
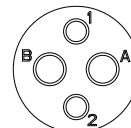
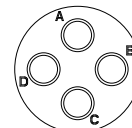
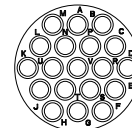

Insert Configuration

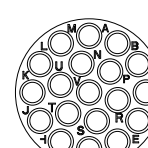
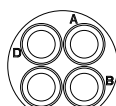
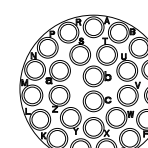
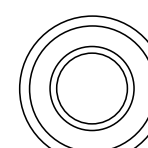
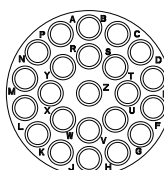
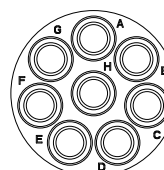
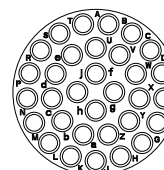
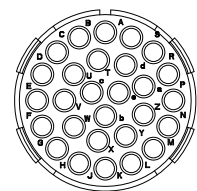
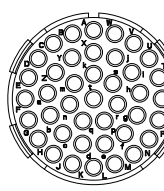
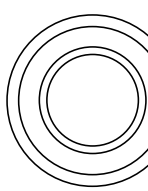
RT			RTOW	RTHP Radsok®	
#16 Contacts (1.6mm) 13A/250V	VDE Versions Mixed Power/Signal	Contacts (2.5mm)	#20 Contacts (1.0mm) 5A/150V (1) 7.5A/150V (2)	Single Pin Power	
Note: Specific to RTOW, (1) refers to Stamped and Formed contacts; (2) refers to Machined contacts.					
Shell 10	 10-4	 10-2 2x#16(13A)/2X#20(5A) 350V AC/DC	N/A	 10-6	N/A
Shell 12	 12-3	N/A	N/A	 12-10	 12-1 1x3.6mm (86A) 600V AC/DC
Shell 14	 14-12	 14-2 2x2.5(23A)/2x#16(13A) 350V AC/DC	 14-4 (23A) 350V AC/DC	 14-19	 14-1 1x6mm (116A) 600V AC/DC
Shell 16	 16-19	 16-4 4x#8(46A) 400 AC/DC	N/A	 16-26	 16-1 1x8mm (185A) 600V AC/DC
Shell 18	 18-23	N/A	 18-8 (23A) 375V AC/DC	 18-32	N/A
Shell 20	 20-28	N/A	N/A	 20-41	 20-1 1x10mm (342A) 600V AC/DC

All dimensions are in mm. Face Views are not actual size and are only meant as a representation.

Box and Wall Mounts

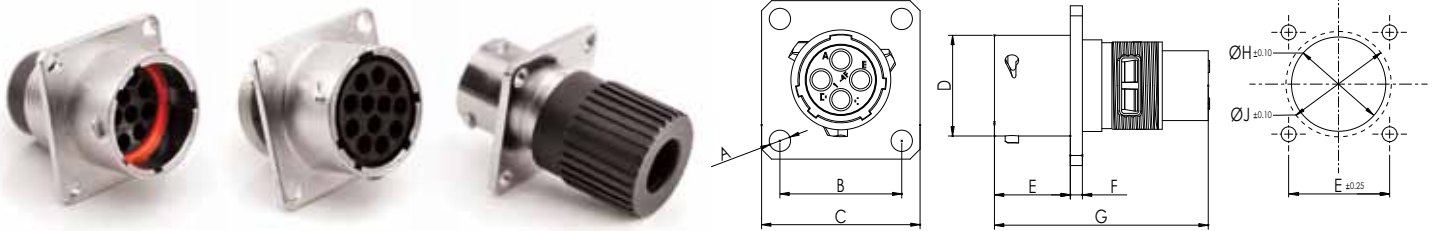

	A	B	C	D	E	F	G	H	J
Shell 10	3.20	18.30	23.80	15.00	11.30	1.80	31.85	17.30	14.20
Shell 12	3.20	20.62	26.20	19.00	11.30	1.80	31.85	21.80	18.40
Shell 14	3.20	23.00	28.60	22.20	11.30	1.80	31.85	25.00	21.50
Shell 16	3.20	24.60	31.00	25.30	11.30	1.80	31.85	28.10	24.60
Shell 18	3.20	26.95	33.30	28.55	11.30	1.80	31.85	31.30	27.80
Shell 20	3.20	29.50	36.50	31.70	14.55	2.40	33.65	34.50	30.90

Straight Plugs

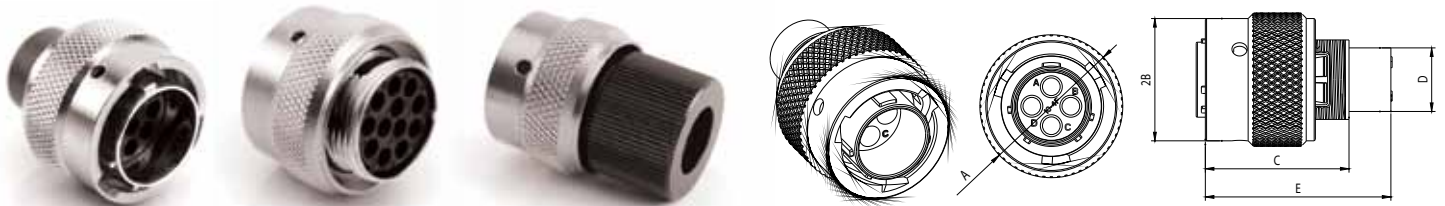

	A	B	C	D	E
Shell 10	21.80	20.00	23.50	10.40	30.35
Shell 12	26.10	23.60	23.50	-	30.35
Shell 14	29.30	26.80	25.32	16.65	32.17
Shell 16	32.45	30.00	23.50	19.50	30.35
Shell 18	35.25	33.30	23.50	21.90	30.45
Shell 20	38.55	36.55	25.80	25.20	30.65

Jam Nut Receptacle

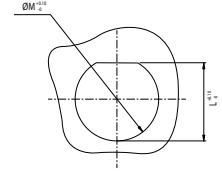
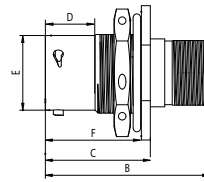
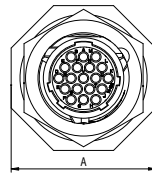

	A	B	C	D	E	F	L	M
Shell 10	27.00	33.00	21.10	10.00	15.00	19.30	16.40	17.30
Shell 12	31.80	33.00	21.10	10.00	19.00	19.30	20.70	22.00
Shell 14	34.90	33.00	21.10	10.00	22.20	19.30	24.00	25.20
Shell 16	38.10	33.00	21.10	10.00	25.30	19.30	27.00	28.30
Shell 18	41.30	33.00	21.10	10.00	28.55	19.30	30.00	31.60
Shell 20	46.10	39.00	26.50	10.00	31.70	24.70	33.80	35.20

Cord Grips

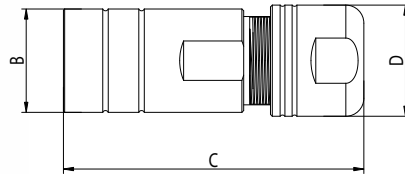

EMC Grounding Ring included

	Amphenol P/N	Cable Range	A (Thread)	B	C
Shell 10	RTOL-10CG-S1	3 to 6.5	9/16-24 UNEF	50.00	18.50
	RTOL-10CG-S2	5 to 8.5			
Shell 12	RTOL-12CG-S1	6 to 10.5	11/16-24 UNEF	54.00	23.00
	RTOL-12CG-S2	8 to 12.5			
Shell 14	RTOL-14CG-S1	6 to 10.5	13/16-20 UNEF	54.00	23.00
	RTOL-14CG-S2	8 to 12.5			
Shell 16	RTOL-16CG-S1	9.5 to 14.5	15/16-20 UNEF	60.00	26.50
	RTOL-16CG-S2	13.5 to 18			
Shell 18	RTOL-18CG-S1	9.5 to 14.5	1" 1/16-18 UNEF	60.00	28.20
	RTOL-18CG-S2	13.5 to 18			
Shell 20	RTOL-20CG-S1	16.5 to 22	1" 3/16-18 UNEF	63.50	33.00
	RTOL-20CG-S2	21.5 to 24			

All dimensions are in mm.

Metal Cable Clamp Cord Grip

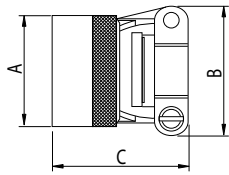

	Amphenol P/N	Max. Cable Diam.	A (Thread)	B	C
Shell 10	RT10SR	5.0	9/16-24 UNEF	21.60	31.00
Shell 12	RT12SR	8.2	11/16-24 UNEF	25.00	31.50
Shell 14	RT14SR	10.0	13/16-20 UNEF	27.40	34.00
Shell 16	RT16SR	13.0	15/16-20 UNEF	29.40	
Shell 18	RT18SR	16.0	1" 1/16-18 UNEF	35.20	31.40
Shell 20	RT20SR	21.0	1" 3/16-18 UNEF	37.60	32.00

Metal Cable Clamp Cord Grip Plating Options Example: RT10SR(); RT10SR1; RT10SR2

(): Standard is nickel plating (48hr salt spray)

1: Black anodized (96hr salt spray)



Wall Mounted Receptacle for Flat Hole Tail

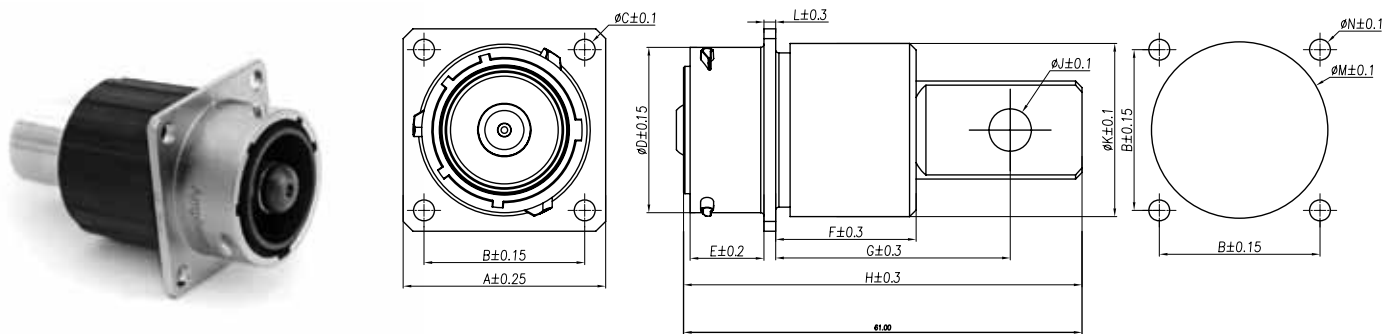

Amphenol P/N		A	B	ΦC	ΦD	E	F	G	H	J	K	L	ΦN	ΦM
Shell 12	RTHP0121PN-H1	26.80	20.60	3.20	19.00	11.35	19.60	34.00	55.10	5.50	21.80	1.80	3.20	22.50
Shell 14	RTHP0141PN-H1	28.60	23.00		22.20		17.20	28.50	53.10	5.50	23.90			24.50
Shell 16	RTHP0161PN-H1	24.60	31.00		25.30		21.50	35.90	61.00	6.50	26.50			27.00
Shell 20	RTHP0201PN-H1	29.40	26.50	4.20	31.70	14.55	22.20	40.10	72.00	8.50	33.50	2.40	4.20	34.00

Straight Cable Plug with Cord Grip Solutions

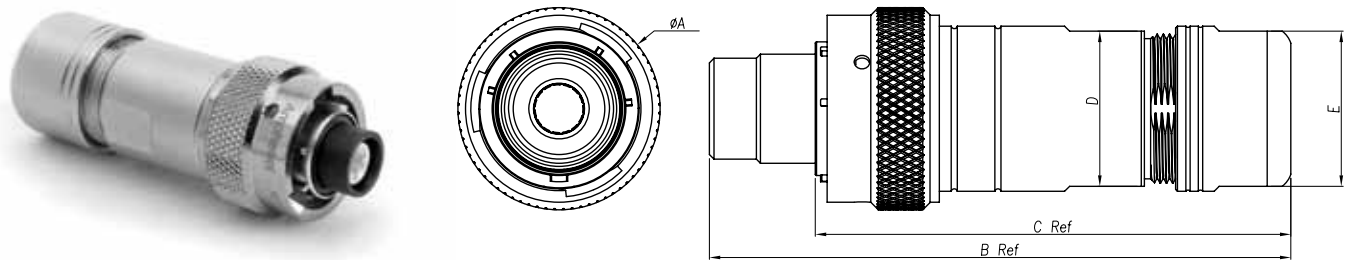

Amphenol P/N		A	B	C	D	E	Wire size	Cable max.
Shell 12	RTHP6121SNH-16S2	26.10	79.30	73.30	19.90	21.90	13-16 mm ²	12.50
Shell 14	RTHP6141SNH-25S2	29.30	86.40	72.30	19.90	21.90	20-25 mm ²	12.50
Shell 16	RTHP6161SNH-35S2	32.50	93.30	76.30	24.90	24.90	30-35 mm ²	17.50
Shell 20	RTHP6201SNH-70S2	38.60	100.90	80.80	28.90	28.90	70-75 mm ²	20.00

All dimensions are in mm.

Straight Cable Plug with End Cap

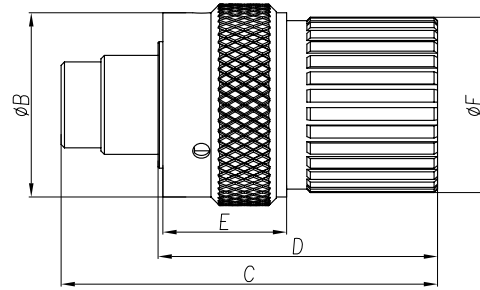
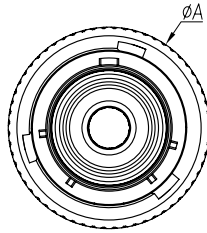

	Amphenol P/N	A	B	C	D	E	ϕF	Wire size	Cable max.
Shell 12	RTHP6121SNH-16EC	26.10	23.60	38.70	32.70	18.00	21.80	13-16 mm ²	12.50
Shell 14	RTHP6141SNH-25EC	29.30	26.80	54.80	40.70		25.50	20-25 mm ²	12.50
Shell 16	RTHP6161SNH-35EC	32.50	30.00	57.70	40.70		27.50	30-35 mm ²	17.50
Shell 20	RTHP6201SNH-70EC	38.60	36.60	62.70	42.70	19.00	34.50	70-75 mm ²	20.00

Straight Cable Plug with 90° Cord Grip Solutions

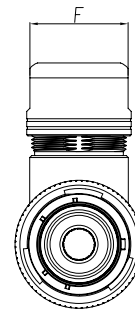
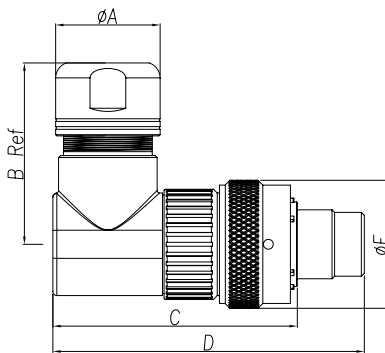

	Amphenol P/N	A	B	C	D	ϕE	ϕF	Wire size	Cable max.
Shell 12	RTHP6121SNH-16BS2	23.00	43.00	58.70	64.70	26.10	21.90	13-16 mm ²	12.50
Shell 14	RTHP6141SNH-25BS2	26.50	46.00	62.00	76.10	29.30	24.90	20-25 mm ²	12.50
Shell 16	RTHP6161SNH-35BS2	26.50	46.00	62.00	79.00	29.30	24.90	30-35 mm ²	17.50
Shell 20	RTHP6201SNH-70BS2	31.00	54.30	75.00	95.00	26.60	29.00	70-75 mm ²	20.00

Accessories & Tooling

Dust Caps

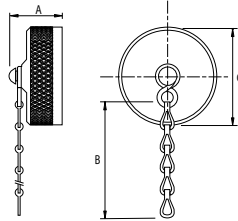

Sealing Plugs



	Amphenol P/N	A max.	B	C max.
Shell 10	RT010DCG	21.80	42.00	30.20
Shell 12	RT012DCG	24.60		
Shell 14	RT014DCG	27.80		
Shell 16	RT016DCG	31.00		
Shell 18	RT018DCG	35.30		
Shell 20	RT020DCG	38.60		

	Amphenol P/N	mm
16AWG	CA-4016-59	1.50
20AWG	CA-4020-59	0.50

Stamp Contact Tool

(Stamped and Formed Contacts)



	Amphenol P/N
16AWG	MFX-3954
20AWG	MFX-3958
2.5mm	MFX-3962

Universal Hand Crimp Tool

(Machined Contacts)



	Amphenol P/N
	MFX-3959

Contact Extraction Tool



	Amphenol P/N
16AWG	QXRT16
20AWG	QXRT20
2.5mm	QXRT12S

All dimensions are in mm.

Crimp Die (Stamped and Formed Contacts)



Amphenol P/N	
16AWG	MFX-3957
20AWG	MFX-3964
2.5mm	MFX-3965

Pneumatic Crimp Tool (Machined Contacts)



Amphenol P/N
MFX-3960

Gaskets

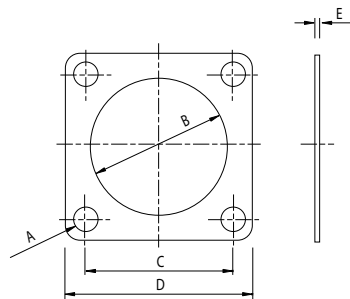

Amphenol P/N		$\varnothing A \pm 0.1$	$\varnothing B \pm 0.01$	$C \pm 0.25$	$D \pm 0.25$	$E \pm 0.2$
Shell 10	RTFD10B	3.30	15.90	18.30	23.80	0.80
Shell 12	RTFD12B		19.00	20.60	26.20	
Shell 14	RTFD14B		22.20	23.00	28.60	
Shell 16	RTFD16B		25.40	24.60	31.00	
Shell 18	RTFD18B		28.60	27.00	33.30	
Shell 20	RTFD20B		31.80	29.40	36.50	

Gasket material is NBR. For other options, please consult factory.

NORTH AMERICA

Amphenol Sine Systems MICHIGAN

44724 Morley Drive
Clinton Township, MI 48036
Toll-Free: 1-800-394-7732
Fax: 1-586-465-1216
Email: sine_info@sineco.com

EUROPE

Amphenol Air LB

29, voie d' Yvois
F-08110 Blagny, France
Phone: 33-3-2422-7849
Fax: 33-3-2422-7875
Email: accueil@amphenol-airlb.fr

Amphenol AIR LB GmbH

Am Kleinbahnhof 4
Saarlouis D-66740, Germany
Phone: 49-6831-981-00
Fax: 49-6831-981-030
Email: info@amphenol-airlb.de

Amphenol BENELUX

Zadelmaker 121
NL-2401PD Alphen aan den Rijn
The Netherlands
Phone: (31) 172 444903
Fax: (31) 172 240254
E-mail: info@amphenol-nl.com

Amphenol CENTER EAST EUROPE, POLAND and AUSTRIA

Wiener Gasse 68
2380 Perchtoldsdorf, Austria
Phone: 43-699-10396071
Fax: 43-699-40396071
Email: c.czesch@amphenol-roe.eu

ASIA

Amphenol Sine Systems CHINA

2/F Building A5, Hua Feng Technology Park
Guan Tian, Bei Huan Road, Shi Yan Street
Bao An District, Shenzhen, China 518108
Tel: 86-755-8173-8000 ext. 8098
Fax: 86-755-8173-8180
Email: fount.nee@amphenolpcd.com.cn

Amphenol INTERCONNECT INDIA PRIVATE LTD

105 Bhosari Industrial Area
Pune 411 026, India
Phone: 91-20-712-0363/0463/0155
Fax: 91-20-712-0581

OTHER LOCATIONS

Amphenol MEXICO

Prolongacion Reforma 61-6 B2
Col. Paseo de las Lomas
C.P. 01330 Mexico DF, Mexico
Phone: 52-55-5258-9984
Fax: 52-55-5081-6890
Email: www.amphenolmexico.com

Amphenol ARGENTINA

Avenida Callao 930
2nd floor Office B Plaza
C1023AAP Buenos Aires, Argentina
Phone: 54-11-4815-6886
Fax: 54-11-4814-5779

Amphenol BRASIL LTDA

Rua Diogo Moreira, 132
20 Andar, Rooms 2001-2-3
CEP 05423-101
Sao Paulo- SP, Brazil
Phone: 55-11-3815-1003
Fax: 55-11-3815-1629
Email: vendas@amphenol.com.br

Amphenol ESPANA

Edificio Burgosal, Oficina N 55
C/Comunidad de Madrid, 35 bis
Las Rozas (Madrid), 28230
Phone: 34-91-6407302
Mobile: 34-629054629
Fax: 34-91-6407307
Email: e.bendix@amphenol-roe.eu

Amphenol ITALIA

Via Barbaiana 5
20020 Lainate, Milano, Italy
Phone: 39-02-932541
Fax: 39-02-9325444
Email: r.buscone@amphenol-roe.eu

Amphenol NORDIC

Appelboms vag 2
SE-18642 Vallentuna, Sweden
Phone: 46-76-8418600
Fax: 46-70-2203197
Email: f.weden@amphenol-roe.eu

Amphenol SOCAPEX

948, Promenade de l'Arve - BP 29
74311 Thyez CEDEX, France
Phone: 33(0)4-50-89-28-40
Fax: 33(0)4-50-96-29-75
Email: jocelyne.anthoine@amphenol-socapex.fr

Amphenol DAESHIN

558, Songnae-2 Dong, SoSa-Gu
Bucheon City, Gyeonggi-do, Korea 422-818
Phone: 81-32-610-3800
Fax: 81-32-673-2507
Email: info@amphenol.co.kr

Amphenol JAPAN

471-1, Deba, Ritto-city
shiga 520-3041, Japan
Phone: 81-77-553-8501
Fax: 81-77-551-2200

Amphenol SOUTH AFRICA

30 Impala Road
2196 Sandton, Chislehurst
South Africa
Phone: 27-11-783-9517
Fax: 27-11-783-9519
Email: amphenol_africa@csi.com

Amphenol AUSTRALIA PTY LIMITED

2 Fiveways Blvd., Keysborough
Melbourne, Victoria 3173 Australia
Phone: 613-8796-8888
Fax: 613-8796-8801

Amphenol TURKEY

Ayazaga Mah. Meyden Sk. No. 28
Beybi Giz Plaza, Kat. 26
34396 Maslak/Istanbul, Turkey
Phone: 90-212-335-2501
Fax: 90-212-335-25-00

Amphenol SWITZERLAND & SOUTH CENTER EUROPE

Switzerland, Slovenia, Serbia, Montenegro,
Yugoslavia, Greece, Bulgaria
948, Promenade de l'Arve - BP29
74311 Thyez - France
Phone: 33-4-50-89-28-00
Fax: 33-4-50-96-29-75

Amphenol TUCHEL GmbH

August-Haeusser-Strasse 10
Heilbronn, 74080
Germany
Phone: 49(0)-7131-929-0
Fax: 49(0)-7131-929-486
Email: info@amphenol.de

Amphenol LIMITED

Thanet Way, Whitstable
Kent CT5 3JF, United Kingdom
Phone: 44-1-227-773200
Fax: 44-1-227-276571