

Bottom View of Assembly

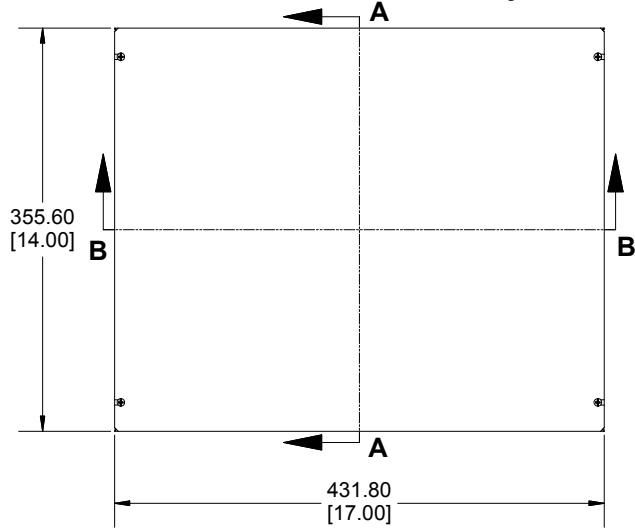

**SECTION A-A
End View of Assembly**

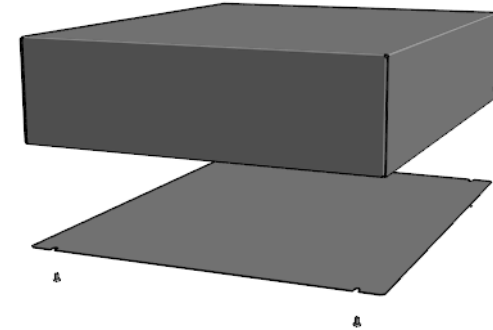
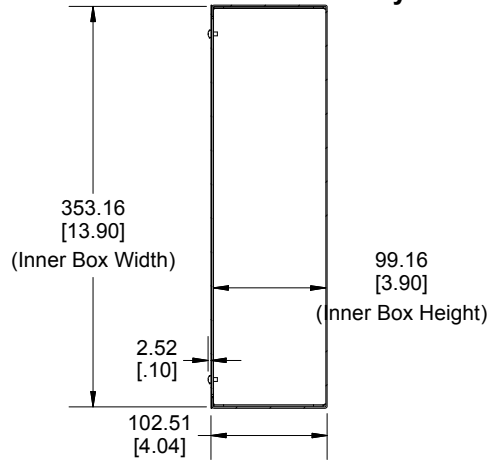

**SECTION B-B
Side View of Assembly**

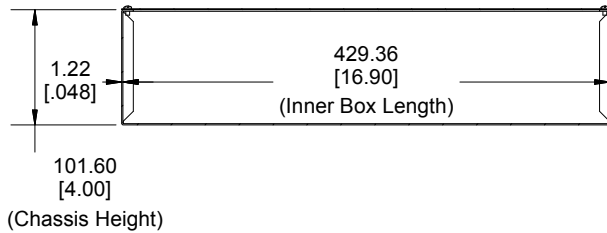

**Bottom View of Chassis
(Sold Separately)**

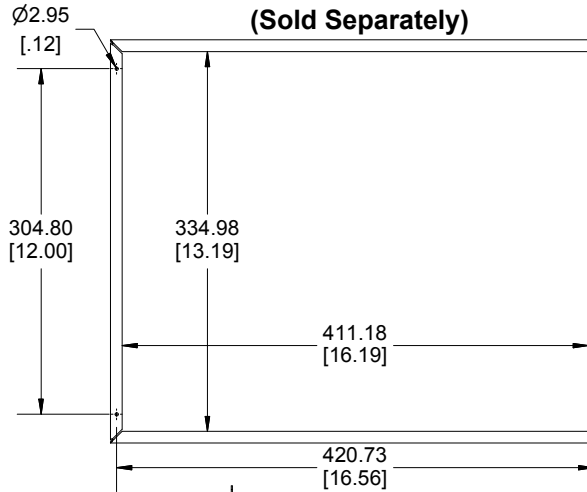

**Bottom Plate
(Sold Separately)**

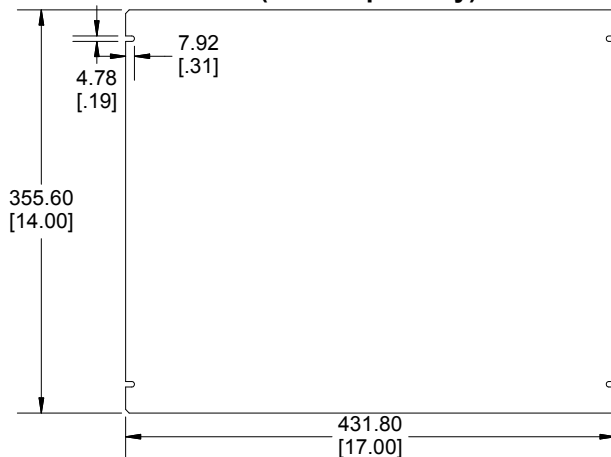

Enclosures can be Factory Modified (Milling, Drilling, Printing etc.)
Contact Factory mjm@hammondmfg.com for quotes
Solid models of this enclosure available in STEP or IGES.

NOTE

All Components Sold Separately
Chassis is Made of 0.048" Steel.
Bottom Plate is Made of 0.036" Steel.

PART NUMBERS

1441-40 Enclosure	
ASA 61 Grey Chassis	1441-40
Satin Black Chassis	1441-40BK3
ACCESSORIES	
ASA 61 Grey Bottom Plate	1431-38
Satin Black Bottom Plate	1431-38BK3
Natural Finish Cover Screws (Pkg 6) [6-32 x 1/4" Self-Tapping Screws]	1421J6
Black Cover Screws (Pkg 6) [6-32 x 1/4" Self-Tapping Screws]	1421J6BK

**HAMMOND
MANUFACTURING™**

1441-40

www.hammondmfg.com

Dimensions:
mm
[inches]