

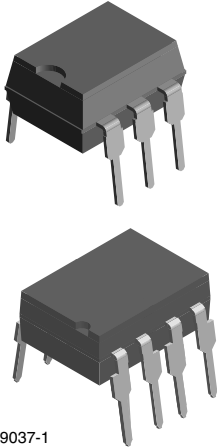

Optocoupler, Phototransistor Output, AC Input, with Base Connection

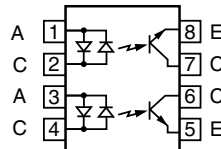

i179037-1

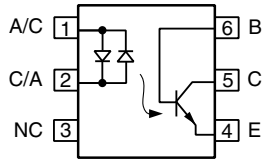

FEATURES

- AC or polarity insensitive inputs
- Built-in reverse polarity input protection
- Improved CTR symmetry
- Industry standard DIP package
- Material categorization:
For definitions of compliance please see www.vishay.com/doc?99912



RoHS COMPLIANT

APPLICATIONS

- Ideal for AC signal detection and monitoring

AGENCY APPROVALS

- UL1577, file no. E52744 system code H, double protection
- CSA 93751
- BSI IEC 60950; IEC 60065
- DIN EN 60747-5-5 (VDE 0884)
- CQC GB4943.1-2011 and GB8898-2011 (suitable for installation altitude below 2000 m)

DESCRIPTION

The IL250, IL251, IL252, ILD250, ILD251, ILD252 are bidirectional input optically coupled isolators consisting of two gallium arsenide infrared LEDs coupled to a silicon NPN phototransistor per channel.

The IL250, ILD250 has a minimum CTR of 50 %, the IL251, ILD251 has a minimum CTR of 20 %, and the IL252, ILD252 has a minimum CTR of 100 %.

The IL250, IL251, IL252 are single channel optocouplers. The ILD250, ILD251, ILD252 has two isolated channels in a single DIP package.

ORDERING INFORMATION

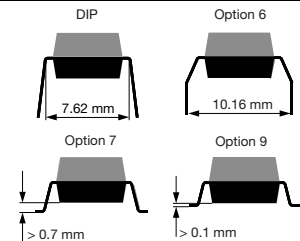
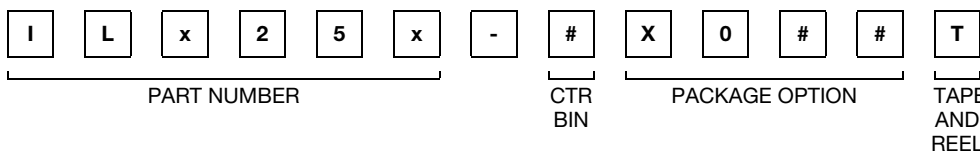

| AGENCY CERTIFIED/PACKAGE | CTR (%) | | | | | |
|-------------------------------|-----------------------|------------|----------------------------|---------------------|-----------------------------|-----------------------------|
| | SINGLE CHANNEL, 6 PIN | | | DUAL CHANNEL, 8 PIN | | |
| UL, CSA, BSI, CQC | ≥ 20 | ≥ 50 | ≥ 100 | ≥ 20 | ≥ 50 | ≥ 100 |
| DIP-# | IL251 | IL250 | IL252 | ILD251 | ILD250 | ILD252 |
| SMD-#, option 7 | - | - | IL252-X007T ⁽¹⁾ | - | - | - |
| SMD-#, option 9 | IL251-X009T | - | IL252-X009T ⁽¹⁾ | - | ILD250-X009T ⁽¹⁾ | ILD252-X009T ⁽¹⁾ |
| VDE, UL, CSA, BSI, CQC | ≥ 20 | ≥ 50 | ≥ 100 | ≥ 20 | ≥ 50 | ≥ 100 |
| DIP-# | - | IL250-X001 | IL252-X001 | - | - | - |
| DIP-#, option 6 | - | - | IL252-X016 | - | - | - |
| SMD-#, option 7 | - | - | IL252-X017T ⁽¹⁾ | - | - | ILD252-X017T ⁽¹⁾ |

Notes

- Additional options may be possible, please contact sales office.
- ⁽¹⁾ Also available in tubes; do not add "T" to end.



| ABSOLUTE MAXIMUM RATINGS ($T_{amb} = 25\text{ }^{\circ}\text{C}$, unless otherwise specified) | | | | |
|--|--|------------|---------------|-----------|
| PARAMETER | TEST CONDITION | SYMBOL | VALUE | UNIT |
| INPUT | | | | |
| Forward continuous current | | I_F | 60 | mA |
| Power dissipation | | P_{diss} | 100 | mW |
| Derate linearly from 25 °C | | | 1.33 | mW/°C |
| OUTPUT | | | | |
| Collector emitter breakdown voltage | | BV_{CEO} | 30 | V |
| Emitter base breakdown voltage | | BV_{EBO} | 5 | V |
| Collector base breakdown voltage | | BV_{CBO} | 70 | V |
| Power dissipation single channel | | P_{diss} | 200 | mW |
| Power dissipation dual channel | | P_{diss} | 150 | mW |
| Derate linearly from 25 °C single channel | | | 2.6 | mW/°C |
| Derate linearly from 25 °C dual channel | | | 2 | mW/°C |
| COUPLER | | | | |
| Isolation test voltage between emitter and detector | | V_{ISO} | 5300 | V_{RMS} |
| Creepage distance | | | ≥ 7 | mm |
| Clearance distance | | | ≥ 7 | mm |
| Isolation resistance | $V_{IO} = 500\text{ V}, T_{amb} = 25\text{ }^{\circ}\text{C}$ | R_{IO} | 10^{12} | Ω |
| | $V_{IO} = 500\text{ V}, T_{amb} = 100\text{ }^{\circ}\text{C}$ | R_{IO} | 10^{11} | Ω |
| Total dissipation single channel | | P_{tot} | 250 | mW |
| Total dissipation dual channel | | P_{tot} | 400 | mW |
| Derate linearly from 25 °C single channel | | | 3.3 | mW/°C |
| Derate linearly from 25 °C dual channel | | | 5.3 | mW/°C |
| Storage temperature | | T_{stg} | - 55 to + 150 | °C |
| Operating temperature | | T_{amb} | - 55 to + 100 | °C |
| Lead soldering time at 260 °C | | | 10 | s |

Note

- Stresses in excess of the absolute maximum ratings can cause permanent damage to the device. Functional operation of the device is not implied at these or any other conditions in excess of those given in the operational sections of this document. Exposure to absolute maximum ratings for extended periods of the time can adversely affect reliability.

| ELECTRICAL CHARACTERISTICS ($T_{amb} = 25\text{ }^{\circ}\text{C}$, unless otherwise specified) | | | | | | | |
|--|---|------|-------------|------|------|------|------|
| PARAMETER | TEST CONDITION | PART | SYMBOL | MIN. | TYP. | MAX. | UNIT |
| INPUT | | | | | | | |
| Forward voltage | $I_F = \pm 10\text{ mA}$ | | V_F | | 1.2 | 1.5 | V |
| OUTPUT | | | | | | | |
| Collector emitter breakdown voltage | $I_C = 1\text{ mA}$ | | BV_{CEO} | 30 | 50 | | V |
| Emitter base breakdown voltage | $I_E = 100\text{ }\mu\text{A}$ | | BV_{EBO} | 7 | 10 | | V |
| Collector base breakdown voltage | $I_C = 10\text{ }\mu\text{A}$ | | BV_{CBO} | 70 | 90 | | V |
| Collector emitter leakage current | $V_{CE} = 10\text{ V}$ | | I_{CEO} | | 5 | 50 | nA |
| COUPLER | | | | | | | |
| Collector emitter saturation voltage | $I_F = \pm 16\text{ mA}, I_C = 2\text{ mA}$ | | V_{CEsat} | | | 0.4 | V |

Note

- Minimum and maximum values are testing requirements. Typical values are characteristics of the device and are the result of engineering evaluation. Typical values are for information only and are not part of the testing requirements.



| CURRENT TRANSFER RATIO ($T_{amb} = 25\text{ }^{\circ}\text{C}$, unless otherwise specified) | | | | | | | |
|---|---|---------------|------------|------|------|------|------|
| PARAMETER | TEST CONDITION | PART | SYMBOL | MIN. | TYP. | MAX. | UNIT |
| I_C/I_F | $I_F = \pm 10\text{ mA}$, $V_{CE} = 10\text{ V}$ | IL250, ILD250 | CTR_{DC} | 50 | | | % |
| | | IL251, ILD251 | CTR_{DC} | 20 | | | % |
| | | IL252, ILD252 | CTR_{DC} | 100 | | | % |
| Symmetry | $I_F = \pm 10\text{ mA}$ | | | 0.50 | 1 | 2 | |

TYPICAL CHARACTERISTICS ($T_{amb} = 25\text{ }^{\circ}\text{C}$, unless otherwise specified)

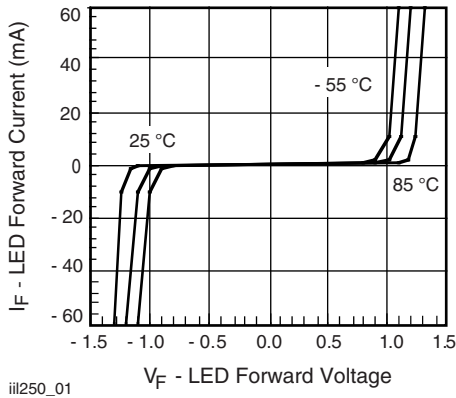

Fig. 1 - LED Forward Current vs. Forward Voltage

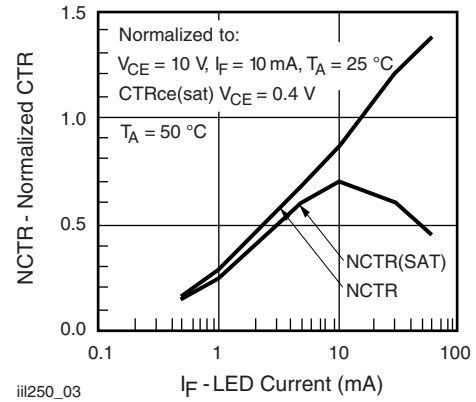

Fig. 3 - Normalized Non-Saturated and Saturated CTR vs. LED Current

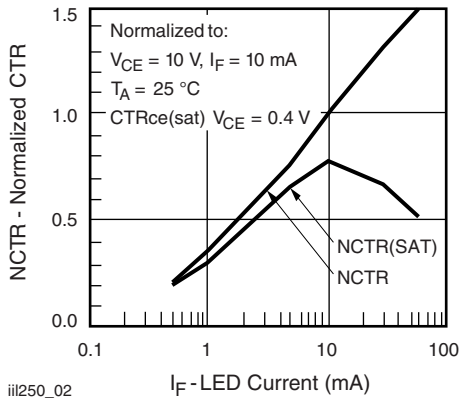

Fig. 2 - Normalized Non-Saturated and Saturated CTR vs. LED Current

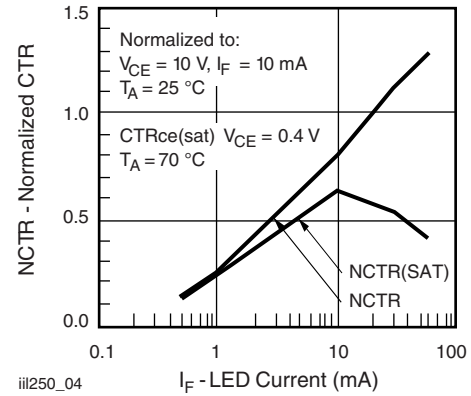

Fig. 4 - Normalized Non-Saturated and Saturated CTR vs. LED Current

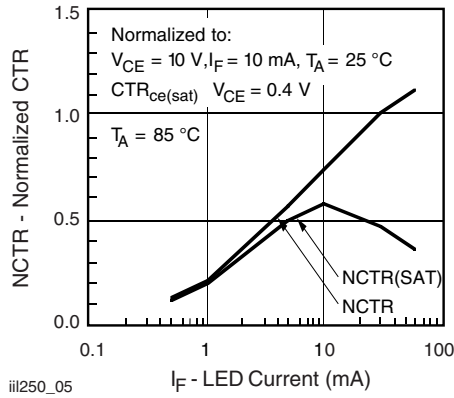

Fig. 5 - Normalized Non-Saturated and Saturated CTR vs. LED Current

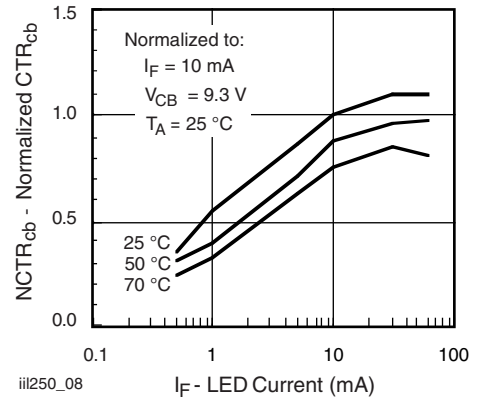

Fig. 8 - Normalized CTR_{CB} vs. LED Current and Temperature

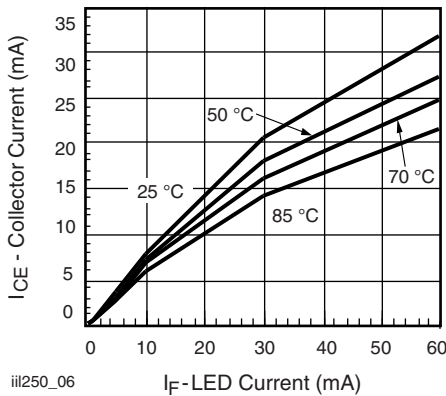

Fig. 6 - Collector Emitter Current vs. Temperature and LED Current

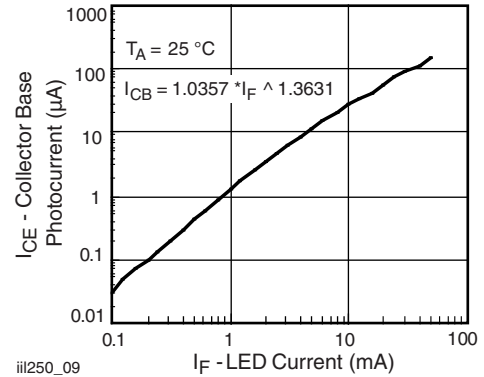

Fig. 9 - Collector Base Photocurrent vs. LED Current

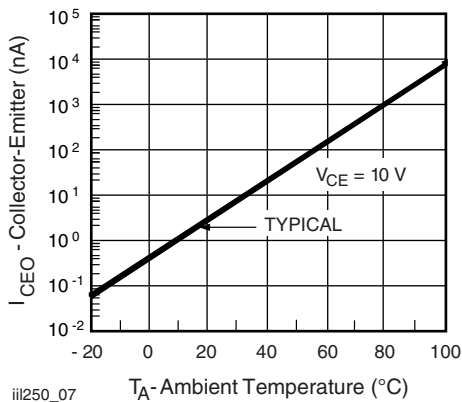

Fig. 7 - Collector Emitter Leakage Current vs. Temperature

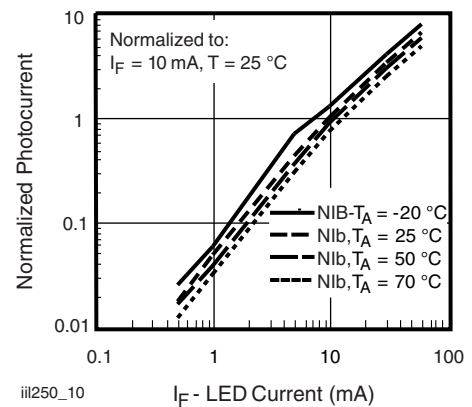

Fig. 10 - Normalized Photocurrent vs. I_F and Temperature

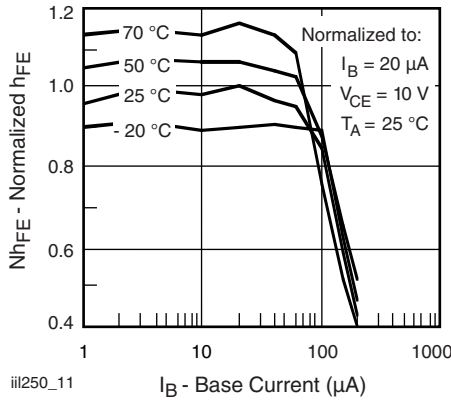

Fig. 11 - Normalized Non Saturated h_{FE} vs. Base Current and Temperature

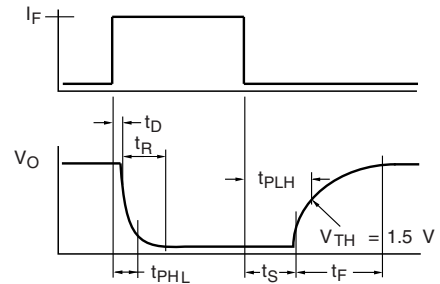

Fig. 14 - Switching Timing

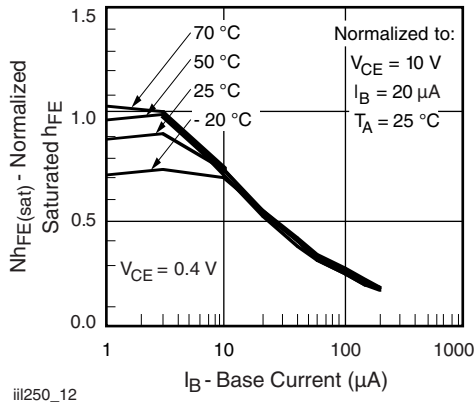

Fig. 12 - Normalized Saturated h_{FE} vs. Base Current and Temperature

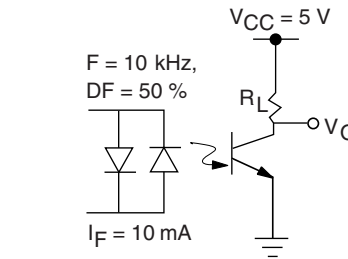

Fig. 15 - Switching Schematic

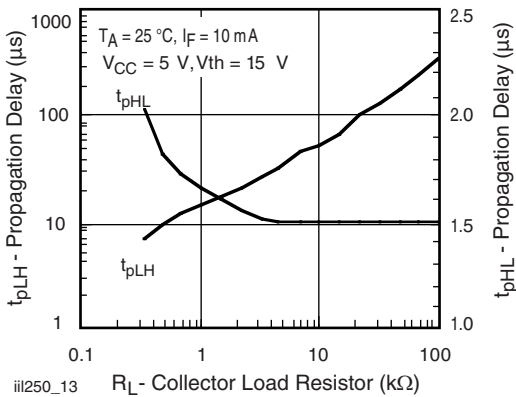
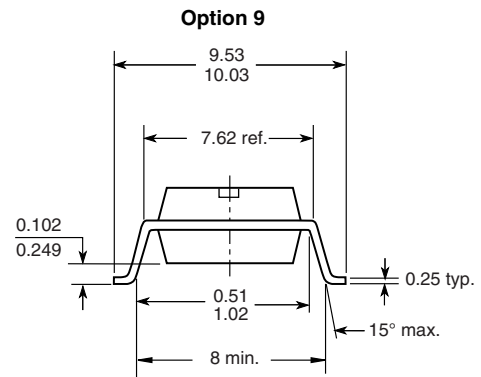
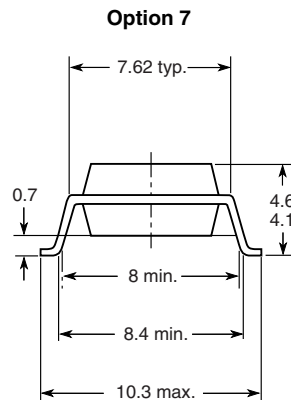
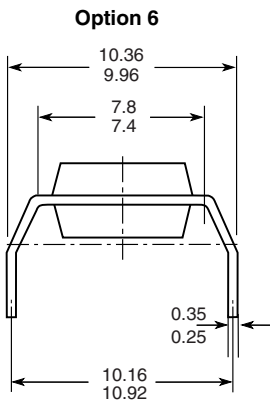
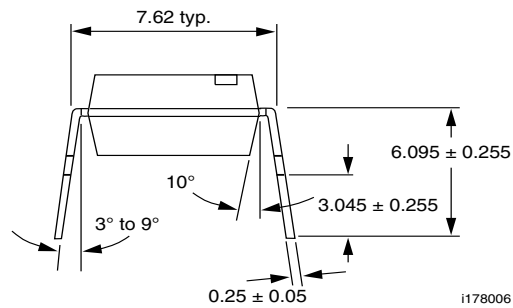
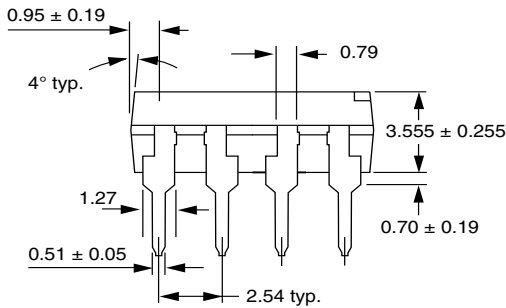
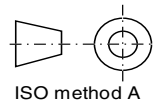
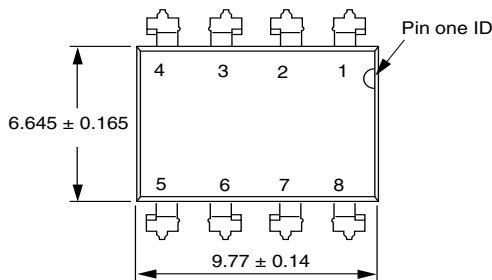
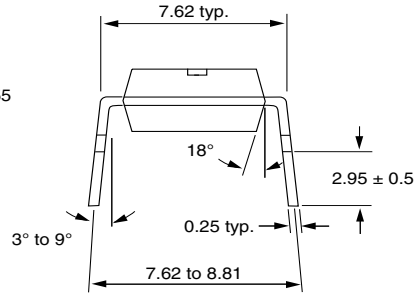
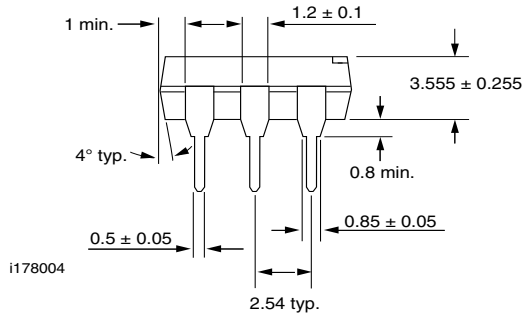
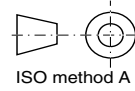
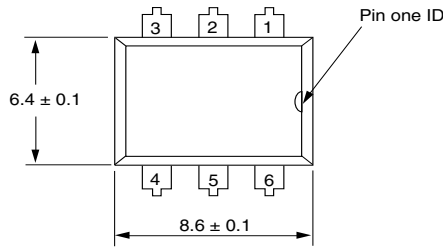

Fig. 13 - Propagation Delay vs. Collector Load Resistor



PACKAGE DIMENSIONS in inches (millimeters)





Disclaimer

ALL PRODUCT, PRODUCT SPECIFICATIONS AND DATA ARE SUBJECT TO CHANGE WITHOUT NOTICE TO IMPROVE RELIABILITY, FUNCTION OR DESIGN OR OTHERWISE.

Vishay Intertechnology, Inc., its affiliates, agents, and employees, and all persons acting on its or their behalf (collectively, "Vishay"), disclaim any and all liability for any errors, inaccuracies or incompleteness contained in any datasheet or in any other disclosure relating to any product.

Vishay makes no warranty, representation or guarantee regarding the suitability of the products for any particular purpose or the continuing production of any product. To the maximum extent permitted by applicable law, Vishay disclaims (i) any and all liability arising out of the application or use of any product, (ii) any and all liability, including without limitation special, consequential or incidental damages, and (iii) any and all implied warranties, including warranties of fitness for particular purpose, non-infringement and merchantability.

Statements regarding the suitability of products for certain types of applications are based on Vishay's knowledge of typical requirements that are often placed on Vishay products in generic applications. Such statements are not binding statements about the suitability of products for a particular application. It is the customer's responsibility to validate that a particular product with the properties described in the product specification is suitable for use in a particular application. Parameters provided in datasheets and/or specifications may vary in different applications and performance may vary over time. All operating parameters, including typical parameters, must be validated for each customer application by the customer's technical experts. Product specifications do not expand or otherwise modify Vishay's terms and conditions of purchase, including but not limited to the warranty expressed therein.

Except as expressly indicated in writing, Vishay products are not designed for use in medical, life-saving, or life-sustaining applications or for any other application in which the failure of the Vishay product could result in personal injury or death. Customers using or selling Vishay products not expressly indicated for use in such applications do so at their own risk. Please contact authorized Vishay personnel to obtain written terms and conditions regarding products designed for such applications.

No license, express or implied, by estoppel or otherwise, to any intellectual property rights is granted by this document or by any conduct of Vishay. Product names and markings noted herein may be trademarks of their respective owners.

Material Category Policy

Vishay Intertechnology, Inc. hereby certifies that all its products that are identified as RoHS-Compliant fulfill the definitions and restrictions defined under Directive 2011/65/EU of The European Parliament and of the Council of June 8, 2011 on the restriction of the use of certain hazardous substances in electrical and electronic equipment (EEE) - recast, unless otherwise specified as non-compliant.

Please note that some Vishay documentation may still make reference to RoHS Directive 2002/95/EC. We confirm that all the products identified as being compliant to Directive 2002/95/EC conform to Directive 2011/65/EU.

Vishay Intertechnology, Inc. hereby certifies that all its products that are identified as Halogen-Free follow Halogen-Free requirements as per JEDEC JS709A standards. Please note that some Vishay documentation may still make reference to the IEC 61249-2-21 definition. We confirm that all the products identified as being compliant to IEC 61249-2-21 conform to JEDEC JS709A standards.