



interface
Solutions for the
Control Cabinet

Catalog 2013





▲ Sales and Marketing Center in Bamberg



▲ Company headquarters in Bamberg



▲ STOCKO main plant in Wuppertal

wieland group

ACTIVE WORLDWIDE

The Wieland Group employs more than 2,000 people all around the globe. With some 15 locations and subsidiaries, and sales partners in more than 70 countries, the Wieland Holding is present in nearly all important key markets worldwide.

Always with a clear commitment to the German location where most of the products are still manufactured.



automation

building

electronics

The group makes us strong

The Wieland Holding is based in Bamberg, Bavaria, and comprises two independently acting subsidiaries: Wieland Electric and STOCKO Contact.

Groundbreaking innovations made Wieland Electric one of the leading suppliers of electrical connection technology. This company, founded in Bamberg in 1910, is the largest subsidiary of the Wieland Holding.

STOCKO Contact is based in Wuppertal and joined the Wieland Group in 2001. Stocko has also more than 100 years of company history to its credit and is one of the greatest manufacturers of connector systems and crimp contacts.



Established in industries

Control cabinet engineering, industrial automation, building system technology – our large product portfolio provides solutions for all kinds of applications.

From innovative interface and network technology to terminal blocks to "safety first" – with modular system solutions and safety components. With Wieland products in your control cabinet, you are always on the safe side.

Energy bus systems for distributed automation or indoor and outdoor field

bus components – Wieland technology can be found everywhere, and in all kinds of applications.

In building system technology, Wieland Electric is the world market leader in pluggable electrical installation.

There are good reasons why our system solutions can be found in the most spectacular building projects worldwide. When it comes to electronic networking, Wieland leads the way to the "intelligent house".

Welcome Future









Wieland Electric is 100 years young, and full of innovative energy. And our commitment for the future is not only to find constantly new system solutions for our customers but also social responsibility.

Environmentally friendly high-tech products, manufactured to the latest production standards, an audited environmental management system and substantial investments in our locations are all part to this concept.

Global commitment and sustainable regional action – Wieland Electric is fit for the future: Contacts are green.



Contents

The Wieland Group	2	
interface	6	
Signal processing throughout your control system with our connectivity solutions		
Protect	10	
wietap overvoltage protection		
Supply	38	
wipos power supplies Pure Power – no frills		
Coupling	46	
wienet / flare / cores always the right connection		
Control	74	
flare ^{TIME} Electronic and electro-mechanical timer and switching relays Control with the right setting		
Measure and monitor	86	
flare ^{CONTROL} Measuring and monitoring relays The right device for every monitoring task		
Additional product lines	92	
Safety, DIN rail terminal blocks, industrial multipole connectors, cable assemblies, distributed automation		
Software Tools	104	
Support and consultation	105	
Subsidiaries and sales representatives	107	

contacts
are
green.



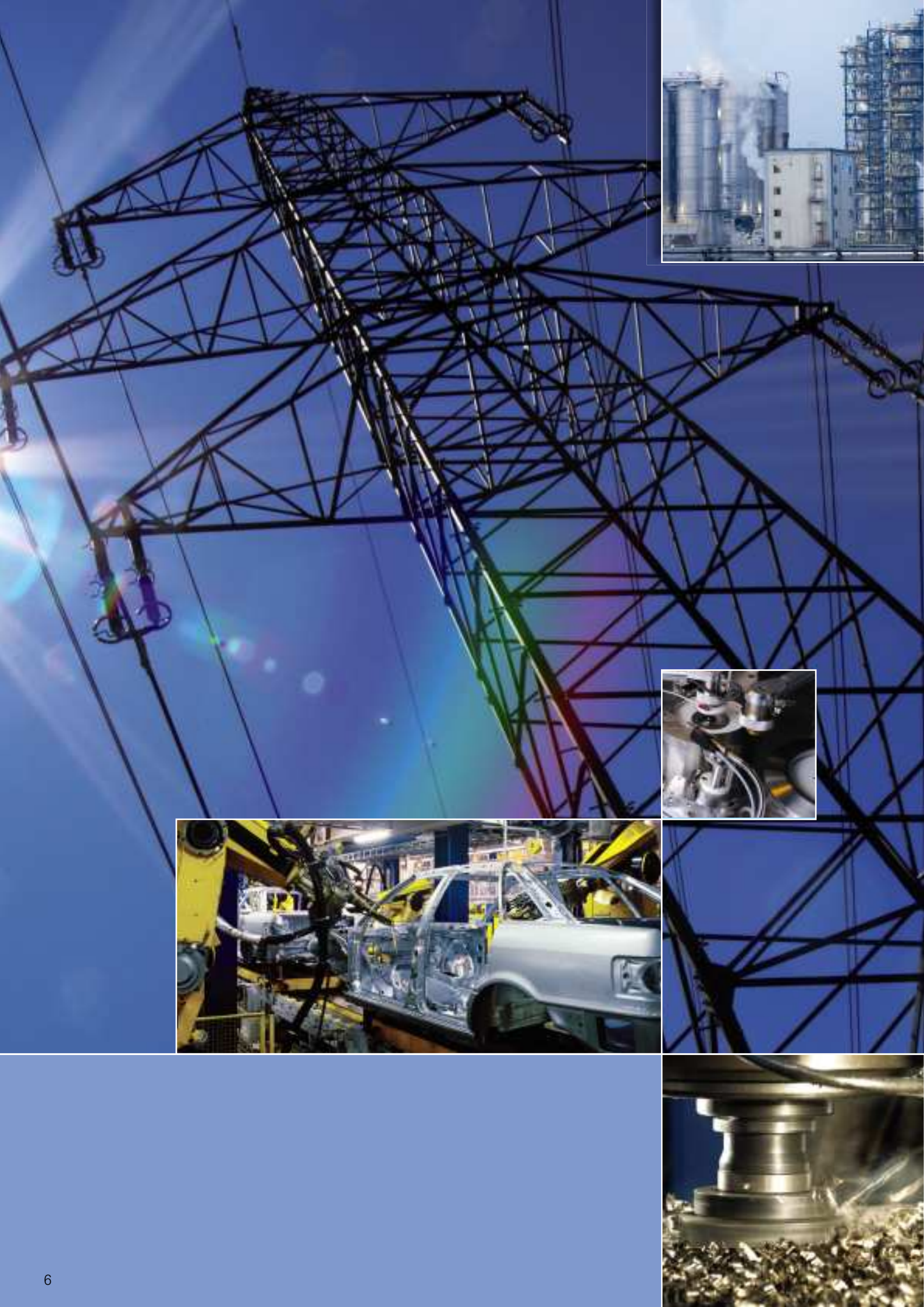

interface

Signal processing

throughout your control system,
with our connectivity solutions



Versatility for every application

Wherever current flows and signals are processed, the unique strengths of Wieland Electric **interface** products shine through. Thanks to a broad range of relays, power supplies and overvoltage protection devices, as well as **interface** and analog modules, your application will also become a real all-rounder. Send all the right signals with our interface technology and innovative DIN rail terminal blocks.



Applications:

- Machine building
- Process control
- Transportation & material handling
- Automotive industry
- Power distribution
- Petrochemical
- Food industry
- Manufacturing engineering





Signal processing

throughout your control system with

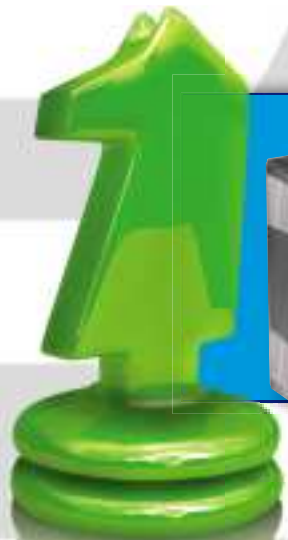

| supply |

wipos power supplies including single-phase and three-phase devices for DIN rail mounting in almost any application



| protection |

wietap overvoltage protection devices for guaranteed highest system availability and device protection

our

connectivity solutions

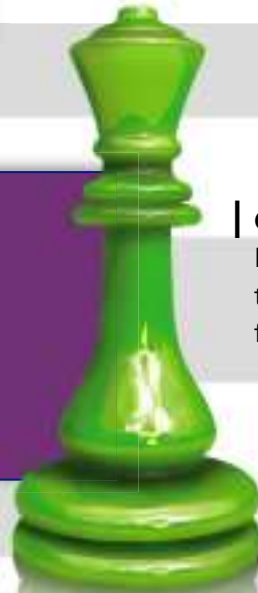
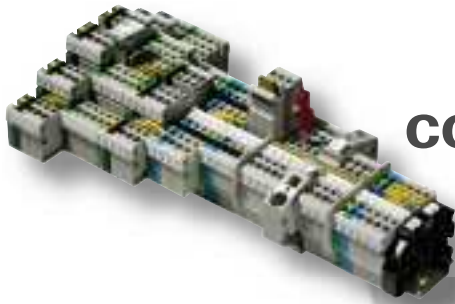

| control |

Electronic and electromechanical timer and multi-function relays **flare** TIME for simple to highly complex control tasks



| coupling |

flare relays for floating coupling of control functions. Analog isolation amplifier **cores** for secure coupling. Ethernet switch series and VPN industrial router **wienet**, for communication.



| measuring and monitoring |

Electronic measuring and monitoring relays **flare** CONTROL for all monitoring and communicating tasks in machines and systems





wietap

Overvoltage protection

Important information on overvoltage

The necessity of overvoltage protection on machines and systems as well as for building technology is ever increasing. The potential danger of damage and even complete destruction posed to valuable electronic components or even complete production systems, computer systems or communication systems by sudden overvoltage from the grid, or direct lightning strikes has mobilized not just insurance companies. Well-advised users also know the importance of protecting their electrical devices, plants and systems both sufficiently and reliably against this danger, and the overall advantage of increasing their system availability.



Overvoltage protection modules

Overvoltage protection modules come in three type categories which designate their capacity to absorb overvoltage energy. Type 1 arresters can divert the largest amount of energy to ground (PE). The ideal installation location for these devices is at the building's main supply. In this configuration the impulse energy is considerably weakened, if it moves downstream into the installation. In sub-panels and control cabinets, this surplus energy is reduced further by type 2 and 3 arresters, thus maintaining the survival of the protected devices.





Table 1

LEMP protection for buildings with electrical and electronic systems according to IEC 62305-4 (DIN EN 62305-4, DIN 0185-305-4)

Lightning protection zones

- LPZ 0_A At risk from direct lightning strikes, impulse currents up to the full lightning current and through the full lightning field.
- LPZ 0_B Protected against direct lightning strike. At risk from impulse currents up to partial lightning currents and through the full lightning field.
- LPZ 1 Impulse currents further limited by current division and SPDs at the zone limits. In most cases, the lightning field is attenuated by shields.
- LPZ 2 Impulse currents further limited by current division and SPDs at the zone limits. In most cases, the lightning field is attenuated by local shields.



Playing it safe with **overvoltage protection**

Very short response time and high discharge capacity

With its considerably expanded **wietap** product range, Wieland Electric offers comprehensive solutions for overvoltage protection in control cabinets and sub panels of machines and buildings, as well as for photovoltaic systems. The components, which are modular and DIN rail mountable, range from the ready-to-connect 3-phase combi-arrester **wietap V M** for the main distribution, to the overvoltage protection module **wietap G M** for sub panels, up to the overvoltage module **wietap R M** intended for the control cabinet or constructed into the equipment. All components are designed for

application temperatures from -40 to 80 °C and have a high discharge capacity. Devices are also available with a remote signaling contact.

Properties of **wietap**:

- Electrically coordinated product family
- Highest discharge capacity up to 100 kA
- No tripping of fuses thanks to follow current limitation
- Latching pluggable protection modules
- Vibration and shock tested acc. to EN 60068-2
- Visual function & defect display for every path
- Modules replaceable without tools
- Can also be used in front of vertical power meter



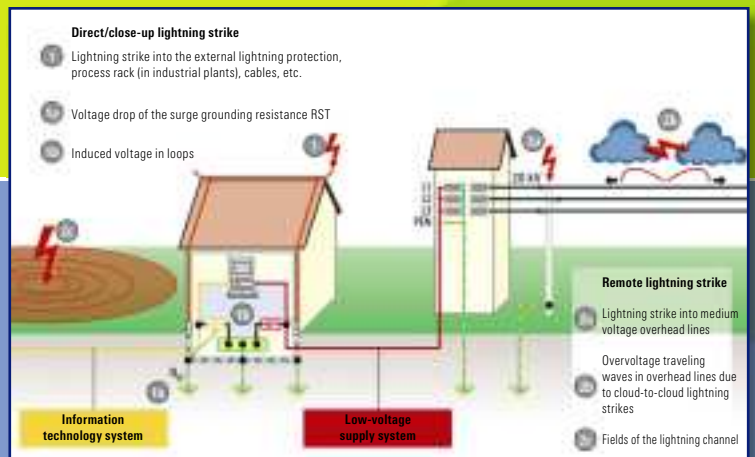
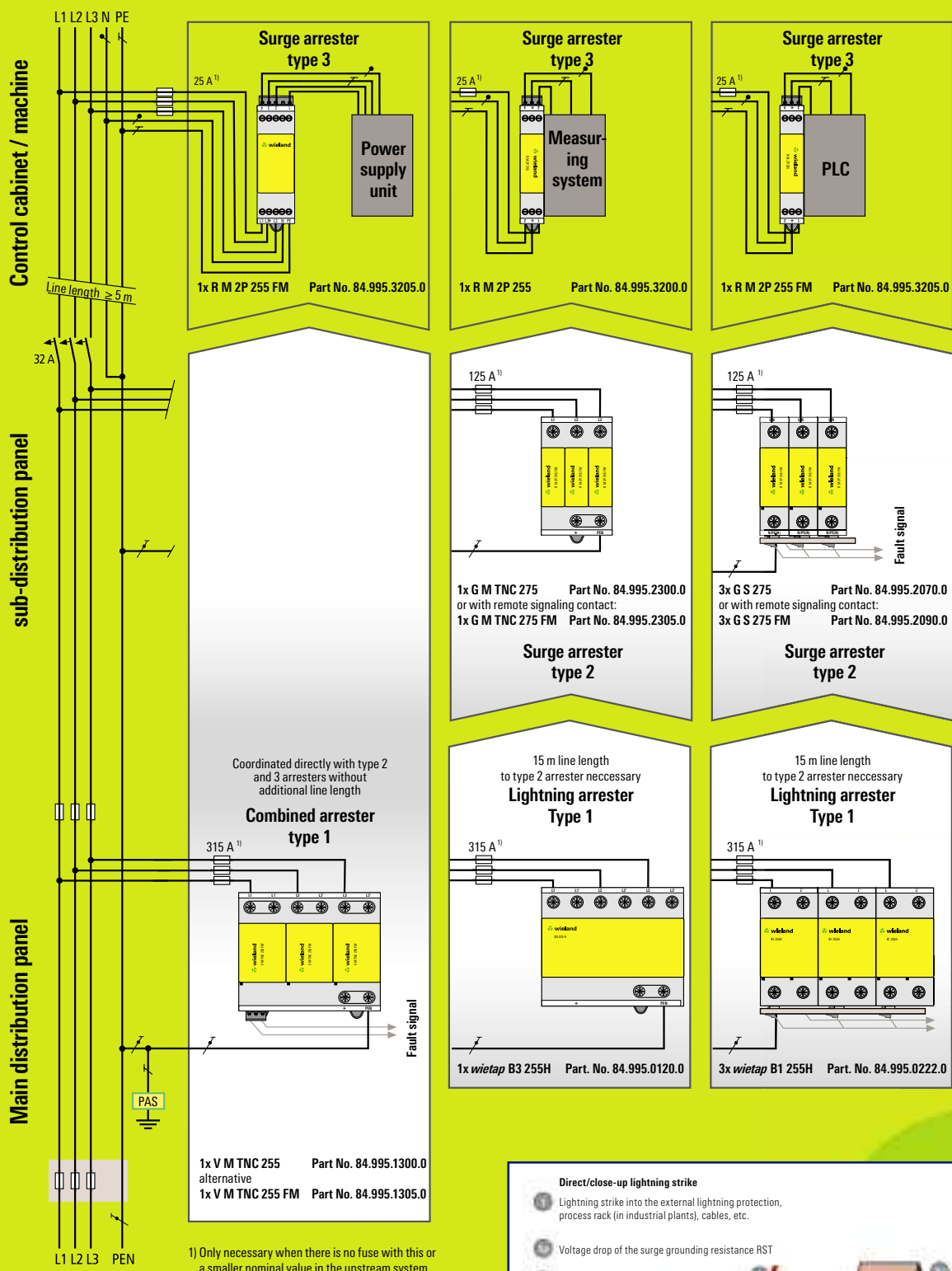

Figure 1

Overvoltage protection

The zone concept for lightning protection

The **zone concept for lightning protection** enables planners, builders and owners to plan, implement and monitor protective measures. All relevant devices, plants and systems can thus be protected reliably at economically justifiable costs..

Direct or close-up lightning strikes are lightning strikes into the lightning protection system of a building, in close proximity to it, or into the electrically conductive systems implemented in the building (e.g. low-voltage supply, telecommunications, control lines. **(Fig. 1)**

Remote lightning strikes are lightning strikes that occur far away from the object to be protected as well as lightning strikes into the medium voltage overhead system or in close proximity to it, or lightning discharge from cloud to cloud **(Fig. 1: cases 2a, 2b and 2c)**.

In addition to a lightning protection system in the building, additional measures for an overvoltage protection of electrical and electronic systems are required in order to **safeguard the continuous availability** of complex power engineering and IT systems even in the case of a direct lightning strike. It is important to consider all the causes for overvoltages.

The zone concept for **lightning protection** as described in IEC 62305-4 (DIN EN 62305-4, DIN 0185-305-4) applies accordingly **(Fig. 3)**. It divides a building into different risk zones. The relevant protective measures can then be derived for each zone, especially the devices and components for lightning and overvoltage protection.

The zones for lightning protection are defined as described in Table 1.

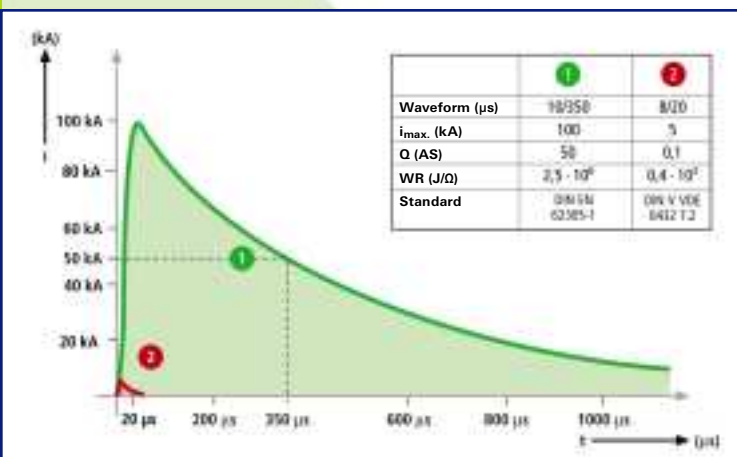

Figure 2: ① Peak current for testing of lightning arresters
 ② Peak current for testing of surge arresters

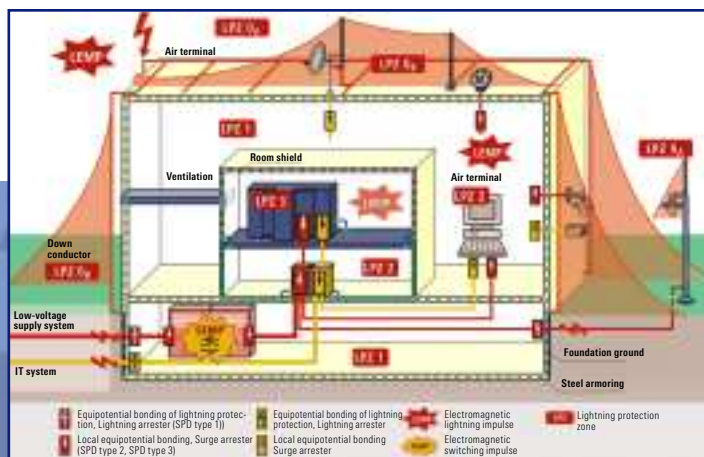

Figure 3: EMC-oriented zone concept for lightning protection

Three-phase combined arrester, type 1 (2, 3)

For protection of the building main supply

wietap V M TNC 255 (FM)

- Combined arrester, type 1
- For TN-C-systems
- With pluggable protection modules
- Max. system availability due to follow current limitation
- Switch-off selective for 20 A gL/gG fuses up to 50 kA_{eff} short-circuit current
- Discharge capacity up to 75 kA (10/350)
- Function/failure indication according to VDE 0100-534
- Optional with remote signaling contact (FM)
- Vibration and shock tested acc. to EN 60068-2

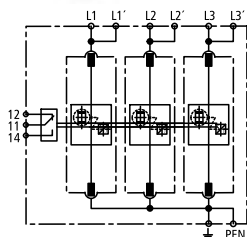

Type	Part No.
wietap V M TNC 255	84.995.1300.0
wietap V M TNC 255 FM	84.995.1305.0
Replacement module L1, L2, L3 against \pm	84.995.1001.0
Power network	TN-C
SPD accord. to EN 61643-11 / IEC 61643-1	Type 1 / Class I
Energy-coordinated protective function to the end device	Type 1 + Type 2
Energy-coordinated protective function to the end device $\leq 5m$	Type 1 + Type 2 + Type 3
Nominal voltage AC [U _N]	230 / 400 V
Nominal frequency [f _N]	50 / 60 Hz
Maximum continuous voltage AC [U _c]	255 V
Lightn. impulse current (10/350) [L1+L2+L3-PEN] [I _{total}]	75 kA
Lightn. impulse current (10/350) [L-PEN] [I _{imp}]	25 kA
Nominal discharge current (8/20) [I _n]	25 / 75 kA
Protection level [U _p]	≤ 1.5 kV
Follow current extinguishing capability AC [I _a]	50 kA _{eff}
Operating time [t _a]	≤ 100 ns
Max. pre-fusing (L) up to I _k = 50 kA _{eff}	315 A gL/gG
Max. pre-fusing (L) up to I _k > 50 kA _{eff}	200 A gL/gG
Max. pre-fusing (L-L')	125 A gL/gG
TOV-voltage [U _T]	440 V / 5 sec.
Temperature range (Parallel wiring) [T _{up}]	-40 ... +80 °C
Temperature range (Through wiring) [T _{us}]	-40 ... +60 °C
Function/failure indication	green / red
Wire range (L1, L1', L2, L2', L3, L3', PEN, \pm) [min.]	10 mm ² (AWG 8) solid/fine-stranded
Wire range (L1, L2, L3, PEN) [max.]	50 mm ² (AWG 1) stranded/35 mm ² (AWG 2) fine-stranded
Wire range (L1', L2', L3', \pm) [max.]	35 mm ² (AWG 2) stranded/25 mm ² (AWG 4) fine-stranded
Mounted on DIN rail acc. to EN 60715	35 mm
Housing material	Thermoplast, UL 94 V-0
Degree of protection	IP 20
Dimensions	6 TE, DIN 43880 (108 mm)
Remote signaling contacts = Contact Type	Change-over contact
Switching capacity AC (FM)	250 V/0.5 A
Switching capacity DC (FM)	250 V/0.1 A; 125 V/0.2 A; 75 V/0.5 A
Wire range for remote signaling terminals	max. 1.5 mm ² (AWG 16) solid/fine-stranded
Approvals	CE

wietap V M TNS 255 (FM)

- Combined arrester Type 1
- For TN-S-systems
- With pluggable protection modules
- Max. system availability due to follow current limitation
- Switch-off selective for 20 A gL/gG fuses up to 50 kA_{eff} short-circuit current
- Discharge capacity up to 100 kA (10/350)
- Function/failure indication according to VDE 0100-534 (valid since March 2009)
- Optional with remote signaling contact (FM)
- Vibration and shock tested acc. to EN 60068-2

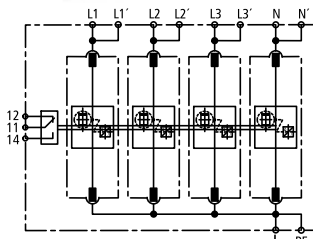

Type	Part No.
wietap V M TNS 255	84.995.1400.0
wietap V M TNS 255 FM	84.995.1405.0
Replacement module L1, L2, L3, N against \pm	84.995.1001.0
Power network	TN-S
SPD accord. to EN 61643-11 / IEC 61643-1	Type 1 / Class I
Energy-coordinated protective function to the end device	Type 1 + Type 2
Energy-coordinated protective function to the end device $\leq 5m$	Type 1 + Type 2 + Type 3
Nominal voltage AC [U _N]	230 / 400 V
Nominal frequency [f _N]	50 / 60 Hz
Maximum continuous voltage AC [U _c]	255 V
Lightn. impulse current (10/350) [L1+L2+L3-PEN] [I _{total}]	100 kA
Lightn. impulse current (10/350) [L, N-PE] [I _{imp}]	25 kA
Nominal discharge current (8/20) [I _n]	25 / 100 kA
Protection level [L, N-PE] [U _p]	≤ 1.5 kV
Follow current extinguishing capability AC [I _a]	50 kA _{eff}
Operating time [t _a]	≤ 100 ns
Max. pre-fusing (L) up to I _k = 50 kA _{eff}	315 A gL/gG
Max. pre-fusing (L) up to I _k > 50 kA _{eff}	200 A gL/gG
Max. pre-fusing (L-L')	125 A gL/gG
TOV-voltage [L-N] [U _T]	440 V / 5 sec.
Temperature range (Parallel wiring) [T _{up}]	-40 ... +80 °C
Temperature range (Through wiring) [T _{us}]	-40 ... +60 °C
Function/failure indication	green / red
Wire range (L1, L1', L2, L2', L3, L3', N, N', PE, \pm) [min.]	10 mm ² (AWG 8) solid/fine-stranded
Wire range (L1, L2, L3, PE, N) [max.]	50 mm ² (AWG 1) stranded/35 mm ² (AWG 2) fine-stranded
Wire range (L1', L2', L3', N', \pm) [max.]	35 mm ² (AWG 2) stranded/25 mm ² (AWG 4) fine-stranded
Mounted on DIN rail acc. to EN 60715	35 mm
Housing material	Thermoplast, UL 94 V-0
Degree of protection	IP 20
Dimensions	8 TE, DIN 43880 (144 mm)
Remote signaling contacts = Contact Type	Change-over contact
Switching capacity AC (FM)	250 V/0.5 A
Switching capacity DC (FM)	250 V/0.1 A; 125 V/0.2 A; 75 V/0.5 A
Wire range for remote signaling terminals	max. 1.5 mm ² (AWG 16) solid/fine-stranded
Approvals	CE

Three-phase combined arrester, type 1 (2, 3)

For protection of the building main supply

wietap V M TT 255 (FM)

- Combined arrester Type 1
- For TT- and TN-S-systems ("3+1" circuits)
- With pluggable protection modules
- Max. system availability due to follow current limitation
- Switch-off selective for 20 A gL/gG fuses up to 50 kA_{eff} short-circuit current
- Discharge capacity up to 100 kA (10/350)
- Function/failure indication according to VDE 0100-534
- Optional with remote signaling contact (FM)
- Vibration and shock tested acc. to EN 60068-2

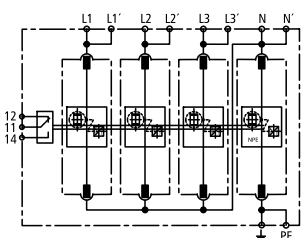

Type	Part No.
wietap V M TT 255	84.995.1310.0
wietap V M TT 255 FM	84.995.1315.0
Replacement module L1, L2, L3 against N	84.995.1001.0
Replacement module N against PE	84.995.1100.0
Power network	TT and TN-S
SPD according to EN 61643-11 / IEC 61643-1	Type 1 / Class I
Energy-coordinated protective function to the end device	Type 1 + Typ 2
Energy-coordinated protective function to the end device ≤ 5m	Type 1 + Type 2 + Type 3
Nominal voltage AC [U _N]	230 / 400 V
Nominal frequency [f _N]	50 / 60 Hz
Maximum continuous voltage AC [U _c]	255 V
Lightn. impulse current (10/350) [L1+L2+L3 +N-PE] [I _{total}]	100 kA
Lightn. impulse current (10/350) [L-N] [I _{imp}]	25 kA
Lightn. impulse current (10/350) [N-PE] [I _{imp}]	100 kA
Nominal discharge current (8/20) [I _n]	25 / 100 kA
Protection level [L-N, N-PE] [U _p]	≤ 1.5 kV
Follow current extinguishing capability [L-N] AC [I _{fc}]	50 kA _{eff}
Follow current extinguishing capability [N-PE] AC [I _{fc}]	100 A _{eff}
Operating time [t _a]	≤ 100 ns
Max. pre-fusing (L) up to I _k = 50 kA _{eff}	315 A gL/gG
Max. pre-fusing (L) up to I _k > 50 kA _{eff}	200 A gL/gG
Max. pre-fusing (L-L')	125 A gL/gG
TOV-voltage [L-N] [U _v]	440 V / 5 sec.
TOV-voltage [N-PE] [U _v]	1200 V / 200 ms
Temperature range (Parallel wiring) [T _{UP}]	-40 ... +80 °C
Temperature range (Through wiring) [T _{US}]	-40 ... +60 °C
Function/failure indication	green / red
Wire range (L1, L1', L2, L2', L3, L3', N, N', PE, PE) [min.]	10 mm ² (AWG 8) solid/fine-stranded
Wire range (L1, L2, L3, N, PE) [max.]	50 mm ² (AWG 1) stranded/35 mm ² (AWG 2) fine-stranded
Wire range (L1', L2', L3', N, PE) [max.]	35 mm ² (AWG 2) stranded/25 mm ² (AWG 4) fine-stranded
Mounted on DIN rail acc. to EN 60715	35 mm
Housing material	Thermoplast, UL 94 V-0
Degree of protection	IP 20
Dimensions	8 TE, DIN 43880 (144 mm)
Remote signaling contacts = Contact Type	Change-over contact
Switching capacity AC (FM)	250 V/0.5 A
Switching capacity DC (FM)	250 V/0.1 A; 125 V/0.2 A; 75 V/0.5 A
Wire range for remote signaling terminals	max. 1.5 mm ² (AWG 16) solid/fine-stranded
Approvals	CE, TÜV, VDE

Replacement module for wietap VM devices

wietap V MOD 255

Network spark gap protection module for all L – PE; L – N and for wietap V M TNS 255 (FM) N – PE



wietap V MOD NPE 100

Network spark gap protection module for wietap V M TT 255 (FM) N – PE



Type	Part No.
wietap V MOD 255	84.995.1001.0
wietap V MOD NPE 100	84.995.1100.0

3-phase lightning arrester, type 1

For protection of the building main supply

wietap B3 255H

- Lightning arrester, type 1
- For all systems (in connection with **wietap** GPM 255 if required)
- High limitation of follow current
- 50 kA discharge capacity per pole
- High insulation resistance; can therefore also be placed in front of the meter
- Double terminals for V connection

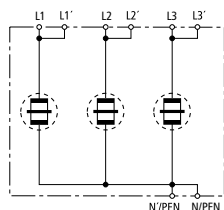

Type	Part No.
wietap B3 255H	84.995.0120.0
Technical Data	
SPD accord. to EN 61643-11	Type 1
SPD accord. to IEC 61643-1	Class I
Nominal voltage AC [U _N]	230/400 V
Maximum continuous voltage AC [U _C]	255 V
Lightn. impulse current (10/350) [L-N/PEN] [I _{imp}]	50 kA
Lightn. impulse current (10/350) [L1+L2+L3-N/PEN] [I _{total}]	100 kA
Nominal discharge current (8/20) [I _n]	50 / 100 kA
Protection level [U _P]	≤ 4 kV
Follow current extinguishing capability AC [I _n]	50 kA _{eff}
Limitation of follow current / selectivity	Non-tripping of a 35 A gL/gG fuse up to 50 kA _{eff} (prosp.)
Operating time [t _A]	≤ 100 ns
Max. pre-fusing bis IK = 50 kA _{eff} (t _a ≤ 0,2 s)	500 A gL/gG
Max. pre-fusing bis IK = 50 kA _{eff} (t _a ≤ 5 s)	315 A gL/gG
Max. pre-fusing bei IK > 50 kA _{eff}	200 A gL/gG
Max. pre-fusing (L-L')	125 A gL/gG
TOV-voltage [U _T]	335 V / 5 sec.
Temperature range (Parallel wiring) [T _{UP}]	-40 ... +80 °C
Temperature range (Through wiring) [T _{US}]	-40 ... +60 °C
Wire range (L1, L1', L2, L2', L3, L3', N/PEN, N'/PEN)	10 mm ² (AWG 8) solid/fine-stranded
Wire range (L1, L2, L3, N/PEN)	50 mm ² (AWG 1) stranded / 35 mm ² (AWG 2) fine-stranded
Wire range (L1', L2', L3', N'/PEN)	35 mm ² (AWG 2) stranded / 25 mm ² (AWG 4) fine-stranded
Mounted on DIN rail acc. to EN 60715	35 mm
Housing material	Thermoplast, UL 94 V-0
Degree of protection	IP 20
Dimensions	6 TE, DIN 43880 (108 mm)
Approvals	CE

1-phase lightning arrester, type 1

For the protection of the building main supply

wietap B1 255H

- Lightning arrester, type 1
- For all systems (in connection with **wietap** GPM 255 if required)
- High limitation of follow current
- 50 kA discharge capacity per pole
- High insulation resistance; can therefore also be placed in front of the meter
- Double terminals for V connection

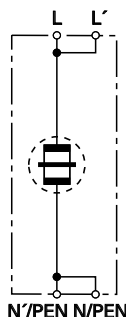

Type	Part No.
wietap B1 255H	84.995.0222.0
Technical Data	
SPD accord. to EN 61643-11	Type 1
SPD accord. to IEC 61643-1	Class I
Nominal voltage ac [U _N]	230 V
Maximum continuous voltage AC [U _C]	255 V
Lightn. impulse current (10/350) [I _{imp}]	50 kA
Nominal discharge current (8/20) [I _n]	50 kA
Protection level [U _P]	≤ 4 kV
Follow current extinguishing capability AC [I _n]	50 kA _{eff}
Limitation of follow current / selectivity	Non-tripping of a 35 A gL/gG fuse up to 50 kA _{eff} (prosp.)
Operating time [t _A]	≤ 100 ns
Max. pre-fusing bis IK = 50 kA _{eff} (t _a ≤ 0,2 s)	500 A gL/gG
Max. pre-fusing bis IK = 50 kA _{eff} (t _a ≤ 5 s)	315 A gL/gG
Max. pre-fusing bei IK > 50 kA _{eff}	200 A gL/gG
Max. pre-fusing (L-L')	125 A gL/gG
TOV-voltage [U _T]	335 V / 5 sec.
Temperature range (Parallel wiring) [T _{UP}]	-40 ... +80 °C
Temperature range (Through wiring) [T _{US}]	-40 ... +60 °C
Wire range (L, L', N/PEN, N'/PEN) [min.]	10 mm ² (AWG 8) solid/fine-stranded
Wire range (L, N/PEN) [max.]	50 mm ² (AWG 1) stranded / 35 mm ² (AWG 2) fine-stranded
Wire range (L', N'/PEN) [max.]	35 mm ² (AWG 2) stranded / 25 mm ² (AWG 4) fine-stranded
Mounted on DIN rail acc. to EN 60715	35 mm
Housing material	Thermoplast, UL 94 V-0
Degree of protection	IP 20
Dimensions	2 TE, DIN 43880 (36 mm)
Approvals	CE

N-PE lightning arrester, type 1

For protection of the building main supply

wietap GMP 255

- N-PE lightning arrester, type 1
- In combination with **wietap** B1 255H or **wietap** B3 255H
- 100 kA discharge capacity

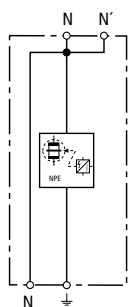

Type	Part No.
wietap GMP 255	84.995.0055.0
Technical Data	
SPD accord. to EN 61643-11	Type 1
SPD accord. to IEC 61643-1	Class I
Maximum continuous voltage AC [U _c]	255 V
Lightn. impulse current (10/350) [I _{imp}]	100 kA
Nominal discharge current (8/20) [I _n]	100 kA
Protection level [U _p]	≤ 1.5 kV
Follow current extinguishing capability AC [I _{eff}]	100 Aeff
Operating time [t _a]	≤ 100 ns
TOV-voltage	1200 V / 200 ms
Temperature range (Parallel wiring) [T _{up}]	-40 ... +80 °C
Temperature range (Through wiring) [T _{us}]	-40 ... +60 °C
Function/failure indication	green / red
Wire range (min.)	10 mm ² (AWG 8) solid/fine-stranded
Wire range (max.)	50 mm ² (AWG 1) stranded / 35 mm ² (AWG 2) fine-stranded
Mounted on DIN rail acc. to EN 60715	35 mm
Housing material	Thermoplast, UL 94 V-0
Degree of protection	IP 20
Dimensions	2 TE, DIN 43880 (36 mm)
Approvals	CE



Three-phase combined arrester, type 2

For protection of sub-distributions or the control cabinet main supply

wietap G M TNC 275 (FM)

- Surge arrester, type 2
- For TN-C-systems
- With pluggable protection modules
- Function/failure indication according to VDE 0100-534
- Optional with remote signaling contact (FM)
- Vibration and shock tested acc. to EN 60068-2

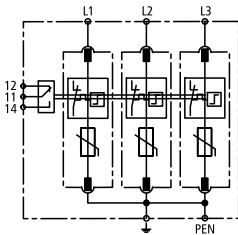

Type	Part No.
wietap G M TNC 275	84.995.2300.0
wietap G M TNC 275 FM	84.995.2305.0
Replacement module L1, L2, L3 against \pm	84.995.2010.0
Power network	TN-C
SPD accord. to EN 61643-11	Type 2
SPD accord. to IEC 61643-1	Class II
Nominal voltage AC [U _N]	230/400 V
Nominal frequency [f _N]	50 / 60 Hz
Maximum continuous voltage AC [U _c]	275 V
Nominal discharge current (8/20) [I _n]	20 kA
Max. discharge current (8/20) [I _{max}]	40 kA
Protection level [U _p]	≤ 1.25 kV
Protection level at 5 kA [U _p]	≤ 1 kV
Operating time [t _a]	≤ 25 ns
Maximum network overcurrent protection	125 A gL/gG
Short-circuit proof with max. network overcurrent protection	50 kA _{eff}
TOV-voltage [U _t]	335 V / 5 sec.
Temperature range [T _U]	-40 ... +80 °C
Function/failure indication	green / red
Wire range (min.)	1.5 mm ² (AWG 14) solid/fine-stranded
Wire range (max.)	35 mm ² (AWG 2) stranded / 25 mm ² (AWG 4) fine-stranded
Mounted on DIN rail acc. to EN 60715	35 mm
Housing material	Thermoplast, UL 94 V-0
Degree of protection	IP 20
Dimensions	3 TE, DIN 43880 (54 mm)
Remote signaling contacts = Contact Type	Change-over contact
Switching capacity AC (FM)	250 V/0.5 A
Switching capacity DC (FM)	250 V/0.1 A; 125 V/0.2 A; 75 V/0.5 A
Wire range for remote signaling terminals	max. 1.5 mm ² (AWG 14) solid/fine-stranded
Approvals	CE

wietap G M TNS 275 (FM)

- Surge arrester, type 2
- For TN-S-systems
- With pluggable protection modules
- Function/failure indication according to VDE 0100-534
- Optional with remote signaling contact (FM)
- Vibration and shock tested acc. to EN 60068-2

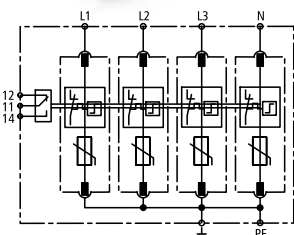

Type	Part No.
wietap G M TNS 275	84.995.2400.0
wietap G M TNS 275 FM	84.995.2405.0
Replacement module L1, L2, L3, N against \pm	84.995.2010.0
Power network	TN-S
SPD accord. to EN 61643-11	Type 2
SPD accord. to IEC 61643-1	Class II
Nominal voltage AC [U _N]	230/400 V
Nominal frequency [f _N]	50 / 60 Hz
Maximum continuous voltage AC [U _c]	275 V
Nominal discharge current (8/20) [I _n]	20 kA
Max. discharge current (8/20) [I _{max}]	40 kA
Protection level [U _p]	≤ 1.25 kV
Protection level at 5 kA [U _p]	≤ 1 kV
Operating time [t _a]	≤ 25 ns
Maximum network overcurrent protection	125 A gL/gG
Short-circuit proof with max. network overcurrent protection	50 kA _{eff}
TOV-voltage [U _t]	335 V / 5 sec.
Temperature range [T _U]	-40 ... +80 °C
Function/failure indication	green / red
Wire range (min.)	1.5 mm ² (AWG 14) solid/fine-stranded
Wire range (max.)	35 mm ² (AWG 2) stranded / 25 mm ² (AWG 4) fine-stranded
Mounted on DIN rail acc. to EN 60715	35 mm
Housing material	Thermoplast, UL 94 V-0
Degree of protection	IP 20
Dimensions	4 TE, DIN 43880 (72 mm)
Remote signaling contacts = Contact Type	Change-over contact
Switching capacity AC (FM)	250 V/0.5 A
Switching capacity DC (FM)	250 V/0.1 A; 125 V/0.2 A; 75 V/0.5 A
Wire range for remote signaling terminals	max. 1.5 mm ² (AWG 14) solid/fine-stranded
Approvals	CE

Three-phase combined arrester, type 2

For protection of sub-distributions or the control cabinet main supply

wietap G M TT 275 (FM)

- Surge arrester, type 2
- For TT- and TN-S-systems ("3+1" circuits)
- With pluggable protection modules
- Function/failure indication according to VDE 0100-534
- Optional with remote signaling contact (FM)
- Vibration and shock tested acc. to EN 60068-2

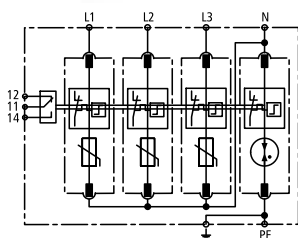

Type	Part No.
wietap G M TT 275	84.995.2310.0
wietap G M TT 275 FM	84.995.2315.0
Replacement module L1, L2, L3 against N	84.995.2010.0
Replacement module N against \varnothing	84.995.2050.0
Power network	TT and TN-S (Variante „3+1“)
SPD accord. to EN 61643-11	Type 2
SPD accord. to IEC 61643-1	Class II
Nominal voltage AC [U _N]	230/400 V
Nominal frequency [f _N]	50 / 60 Hz
Maximum continuous voltage AC [L-N] [U _c]	275 V
Maximum continuous voltage AC [N-PE] [U _c]	255 V
Nominal discharge current (8/20) [I _n]	20 kA
Max. discharge current (8/20) [I _{max}]	40 kA
Lightn. impulse current (10/350) [N-PE] [I _{imp}]	12 kA
Protection level [L-N] [U _p]	≤ 1.25 kV
Protection level [L-N] at 5 kA [U _p]	≤ 1 kV
Protection level [N-PE] [U _p]	≤ 1.5 kV
Follow current extinguishing capability [N-PE] [I _{eff}]	100 A _{eff}
Operating time [L-N] [t _a]	≤ 25 ns
Operating time [N-PE] [t _a]	≤ 100 ns
Maximum network overcurrent protection	125 A gL/gG
Short-circuit proof with network overcurrent protection with 25 A gL/gG	50 kA _{eff}
TOV-voltage [L-N] [U _T]	335 V / 5 sec.
TOV-voltage [N-PE] [U _T]	1200 V / 200 ms
Temperature range [T _U]	-40 ... +80 °C
Function/failure indication	green / red
Wire range (min.)	1.5 mm ² (AWG 14) solid/fine-stranded
Wire range (max.)	35 mm ² (AWG 2) stranded / 25 mm ² (AWG 4) fine-stranded
Mounted on DIN rail acc. to EN 60715	35 mm
Housing material	Thermoplast, UL 94 V-0
Degree of protection	IP 20
Dimensions	4 TE, DIN 43880 (72 mm)
Remote signaling contacts = Contact Type	Change-over contact
Switching capacity AC (FM)	250 V/0.5 A
Switching capacity DC (FM)	250 V/0.1 A; 125 V/0.2 A; 75 V/0.5 A
Wire range for remote signaling terminals	max. 1.5 mm ² (AWG 14) solid/fine-stranded
Approvals	CE

Replacement module for wietap G M devices

wietap G MOD 275

Varistor protection module for all L – \varnothing ; L – N and for wietap G M TNS 275 (FM) N – \varnothing



wietap G MOD NPE

Spark gap protection module for N – \varnothing and for wietap G M TT 275 (FM) N – \varnothing



Type	Part No.
wietap G MOD 275	84.995.2010.0
wietap G MOD NPE	84.995.2050.0

Single-phase surge arrester, type 2

For protection of sub-distributions or the control cabinet main supply

wietap G S 275 (FM)

- Surge arrester, type 2
- All-purpose surge arrester
- With pluggable protection modules
- High discharge capacity due to powerful zinc oxid varistor
- High reliability due to arrester monitoring
- Slim design (modular construction) acc. to DIN 43880
- Multi-function connection for conductors and comb rails
- Function/failure indication according to VDE 0100-534
- Optional with remote signaling contact (FM)
- Vibration and shock tested acc. to EN 60068-2

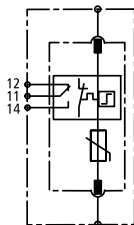

Type	Part No.
wietap G S 275	84.995.2070.0
wietap G S 275 FM	84.995.2090.0
Power network	universal
SPD accord. to EN 61643-11	Type 2
SPD accord. to IEC 61643-1	Class II
Maximum continuous voltage AC [U _c]	275 V
Nominal frequency [f _n]	50 / 60 Hz
Maximum continuous voltage DC [U _c]	350 V
Nominal discharge current (8/20) [I _n]	20 kA
Max. discharge current (8/20) [I _{max}]	40 kA
Protection level [U _p]	≤ 1.25 kV
Protection level at 5 kA [U _p]	≤ 1 kV
Operating time [t _a]	≤ 25 ns
Maximum network overcurrent protection	125 A gL/gG
Short-circuit proof with max. network overcurrent protection	50 kA _{eff}
TOV-voltage [U _T]	335 V / 5 sec.
Temperature range [T _U]	-40 ... +80 °C
Function/failure indication	green / red
Wire range (min.)	1.5 mm ² (AWG 14) solid/fine-stranded
Wire range (max.)	35 mm ² (AWG 2) stranded / 25 mm ² (AWG 4) fine-stranded
Mounted on DIN rail acc. to EN 60715	35 mm
Housing material	Thermoplast, UL 94 V-0
Degree of protection	IP 20
Dimensions	1 TE, DIN 43880 (18 mm)
Remote signaling contacts = Contact Type	Change-over contact
Switching capacity AC (FM)	250 V/0,5 A
Switching capacity DC (FM)	250 V/0.1 A; 125 V/0.2 A; 75 V/0.5 A
Wire range for remote signaling terminals	max. 1.5 mm ² (AWG 14) solid/fine-stranded
Approvals	CE

wietap G MOD 275

- Replacement module for wietap G S 275 (FM)



Type	Part No.
wietap G MOD 275	84.995.2010.0

Single-phase surge arrester, type 2

For protection of sub-distributions or the control cabinet main supply

wietap GP C S (FM)

- Surge arrester, type 2
- For use in TT systems in "3+1" and "1+1" circuits acc. to E DIN VDE 0100-534 between neutral conductor N and protective conductor PE
- High discharge capacity
- With pluggable protection modules
- Function/failure indication according to VDE 0100-534
- Optional with remote signaling contact (FM)
- Vibration and shock tested acc. to EN 60068-2

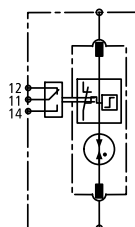

Type	Part No.
wietap GP C S	84.995.2030.0
wietap GP C S FM	84.995.2035.0
Power network	TT
SPD accord. to EN 61643-11	Type 2
SPD accord. to IEC 61643-1	Class II
Maximum continuous voltage AC [U _c]	255 V
Nominal frequency [f _N]	50 / 60 Hz
Nominal discharge current (8/20) [I _n]	20 kA
Max. discharge current (8/20) [I _{max}]	40 kA
Follow current extinguishing capability [I _{eff}]	100 A _{eff}
Lightn. impulse current (10/350) [I _{imp}]	12 kA
Protection level [U _p]	≤ 1.5 kV
Operating time [t _a]	≤ 100 ns
TOV-voltage [U _T]	1200 V / 200 ms
Temperature range [T _U]	-40 ... +80 °C
Function/failure indication	green / red
Wire range (min.)	1.5 mm ² (AWG 14) solid/fine-stranded
Wire range (max.)	35 mm ² (AWG 2) stranded / 25 mm ² (AWG 4) fine-stranded
Mounted on DIN rail acc. to EN 60715	35 mm
Housing material	Thermoplast, UL 94 V-0
Degree of protection	IP 20
Dimensions	1 TE, DIN 43880 (18 mm)
Remote signaling contacts = Contact Type	Change-over contact
Switching capacity AC(FM)	250 V/0.5 A
Switching capacity DC (FM)	250 V/0.1 A; 125 V/0.2 A; 75 V/0.5 A
Wire range for remote signaling terminals	max. 1.5 mm ² (AWG 14) solid/fine-stranded
Approvals	CE

wietap GP C MOD

- Replacement module for wietap G CS (FM)



Type	Part No.
wietap GP C MOD	84.995.2060.0



Surge arrester, type 3

For direct load protection in control cabinets or sub-distributions

wietap R M 2P 30 FM wietap R M 2P 255 (FM)

- Surge arrester, type 3
- Two-pole surge arrester
- High discharge capacity due to powerful zinc oxide varistor
- Slim design (modular construction) acc. to DIN 43880
- With pluggable protection modules
- Function/failure indication according to VDE 0100-534
- Optional with remote signaling contact (FM)
- Vibration and shock tested acc. to EN 60068-2

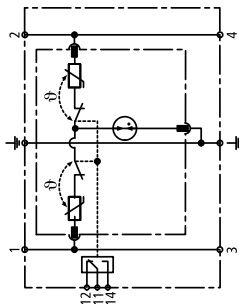

Type	Part No.	Part No.
wietap R M 2P 30 FM		84.995.3206.0
wietap R M 2P 255	84.995.3200.0	
wietap R M 2P 255 FM	84.995.3205.0	
SPD accord. to EN 61643-11	Type 3	Type 3
SPD accord. to IEC 61643-1	Class III	Category A / Class III
Nominal voltage AC [U _N]	230 V	24 V
Maximum continuous voltage AC [U _C]	255 V	30 V
Maximum continuous voltage DC [U _C]	255 V	30 V
Nominal load current AC [I _N]	25 A	25 A
Nominal discharge current (8/20) [I _N]	3 kA	1 kA
Total discharge current (8/20) [L+N-PE] [I _{total}]	5 kA	2 kA
Combined surge [U _{oc}]	6 kV	2 kV
Combined surge [L+N-PE] [U _{oc total}]	10 kV	4 kV
Protection level [L-N] [U _p]	≤ 1250 V	≤ 180 V
Protection level [L/N-PE] [U _p]	≤ 1500 V	≤ 630 V
Operating time [L-N] [t _A]	≤ 25 ns	≤ 25 ns
Operating time [L/N-PE] [t _A]	≤ 100 ns	≤ 100 ns
Maximum network overcurrent protection	25 A gL/gG oder B 25 A	25 A gL/gG oder B 25 A
Short-circuit proof with network overcurrent protection with 25 A gL/gG	6 kA _{rms}	6 kA _{rms}
TOV-voltage [L-N] [U _T]	335 V / 5 sec.	--
TOV-voltage [L/N-PE] (I) [U _T]	400 V / 5 sec.	--
TOV-voltage [L+N-PE] (II) [U _T]	1200 V + U _o / 200 ms	--
Temperature range [T _i]	-40 ... +80 °C	
Function/failure indication	green / red	
Wire range min.	0.5 mm ² (AWG 20) solid/fine-stranded	
Wire range max.	4 mm ² (AWG 12) solid / 2.5 mm ² (AWG 14) fine-stranded	
Mounted on DIN rail acc. to EN 60715	35 mm	
Housing material	Thermoplast, UL 94 V-0	
Degree of protection	IP 20	
Dimensions	1 TE, DIN 43880 (18 mm)	
Remote signaling contacts = Contact Type	Change-over contact	
Switching capacity AC (FM)	250 V/0.5 A	
Switching capacity DC (FM)	250 V/0.1 A; 125 V/0.2 A; 75 V/0.5 A	
Wire range for Remote signaling terminals	max. 1.5 mm ² (AWG 16) solid/fine-stranded	
Approvals		

wietap R MOD 255

- Replacement module for wietap R M 2P 255 (FM)



Type	Part No.
wietap R MOD 255	84.995.3010.0

Surge arrester, type 3

For direct load protection in control cabinets or sub-distributions

wietap R M 4P 255 (FM)

- Surge arrester, type 3
- Four-pole surge arrester
- High discharge capacity due to powerful zinc oxide varistor
- Slim design (modular construction) acc. to DIN 43880
- With pluggable protection modules
- Function/failure indication according to VDE 0100-534
- Optional with remote signaling contact (FM)
- Vibration and shock tested acc. to EN 60068-2

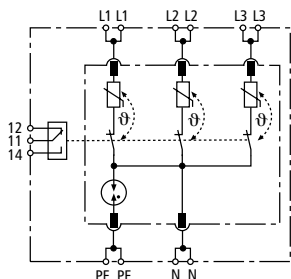

Type	Part No.
wietap R M 4P 255	84.995.3400.0
wietap R M 4P 255 FM	84.995.3405.0
Technical Data	
SPD accord. to EN 61643-11	Type 3
SPD accord. to IEC 61643-1	Class III
Nominal voltage AC [U _N]	230/400 V
Maximum continuous voltage AC [U _c]	255/440 V
Nominal load current AC [I _L]	25 A
Nominal discharge current (8/20) [I _n]	3 kA
Total discharge current (8/20) [L+N-PE] [I _{total}]	8 kA
Combined surge [U _{oc}]	6 kV
Combined surge [L+N-PE] [U _{oc total}]	16 kV
Protection level [L-N] [U _p]	≤ 1000 V
Protection level [L/N-PE] [U _p]	≤ 1500 V
Operating time [L-N] [t _Δ]	≤ 25 ns
Operating time [L/N-PE] [t _Δ]	≤ 100 ns
Maximum network overcurrent protection	25 A gL/gG oder B 25 A
Short-circuit proof with network overcurrent protection with 25 A gL/gG	6 kA _{eff}
TOV-voltage [L-N] [U _T]	335 V / 5 sec.
TOV-voltage [L/N-PE] (I) [U _T]	400 V / 5 sec.
TOV-voltage [L+N-PE] (II) [U _T]	1200 V + U ₀ / 200 ms
Temperature range [T _U]	-40 ... +80 °C
Function/failure indication	green / red
Wire range (min.)	0.5 mm ² (AWG 20) solid/fine-stranded
Wire range (max.)	4 mm ² (AWG 12) solid / 2.5 mm ² (AWG 14) fine-stranded
Mounted on DIN rail acc. to EN 60715	35 mm
Housingwerkstoff	Thermoplast, UL 94 V-0
Degree of protection	IP 20
Dimensions	2 TE, DIN 43880 (36 mm)
Remote signaling contacts = Contact Type	Change-over contact
Switching capacity AC (FM)	250 V/0.5 A
Switching capacity DC (FM)	250 V/0.1 A; 125 V/0.2 A; 75 V/0.5 A
Wire range for remote signaling terminals	max. 1.5 mm ² (AWG 16) solid/fine-stranded
Approvals	CE

wietap R M MOD 4P 255

- Replacement module for wietap R M 4P 255



Type	Part No.
wietap R M MOD 4P 255	84.995.3020.0

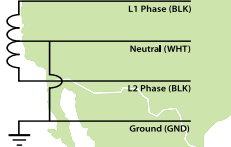
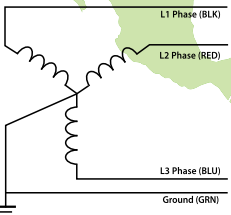
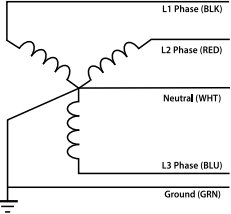
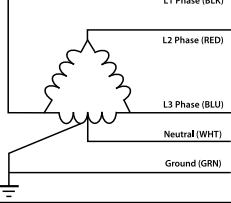
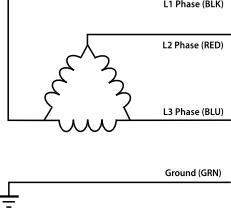
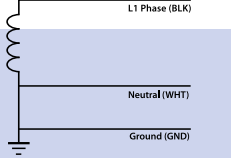
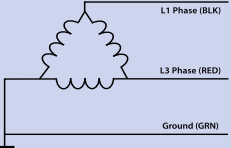

Solutions for Category B for the different mains systems: Selection Matrix

Circuit	Circuit Voltage Configuration	Used Types	Connected between
	120/240V Split Phase 1Ø 3W + Grnd	wietap G S 150 FM UL wietap G S 150 FM UL	L1 Phase-Grnd L2 Phase-Grnd
	240/480V Split Phase 1Ø 3W + Grnd	wietap G S 320 FM UL wietap G S 320 FM UL	L1 Phase-Grnd L2 Phase-Grnd
	127/254V Split Phase 1Ø 3W + Grnd	wietap G S 150 FM UL wietap G S 150 FM UL	L1 Phase-Grnd L2 Phase-Grnd
	120/208V Wye 3Ø 3W + Grnd	wietap G S 150 FM UL wietap G S 150 FM UL wietap G S 150 FM UL	L1 Phase-Grnd L2 Phase-Grnd L3 Phase-Grnd
	277/480V Wye 3Ø 3W + Grnd	wietap G S 320 FM UL wietap G S 320 FM UL wietap G S 320 FM UL	L1 Phase-Grnd L2 Phase-Grnd L3 Phase-Grnd
	347/600V Wye 3Ø 3W + Grnd	wietap G S 440 FM UL wietap G S 440 FM UL wietap G S 440 FM UL	L1 Phase-Grnd L2 Phase-Grnd L3 Phase-Grnd
	120/208V Wye 3Ø 4W + Grnd	wietap G S 150 FM UL wietap G S 150 FM UL wietap G S 150 FM UL wietap G S 150 FM UL	L1 Phase-Grnd L2 Phase-Grnd L3 Phase-Grnd Neutral-Grnd
	277/480V Wye 3Ø 4W + Grnd	wietap G S 320 FM UL wietap G S 320 FM UL wietap G S 320 FM UL wietap G S 320 FM UL	L1 Phase-Grnd L2 Phase-Grnd L3 Phase-Grnd Neutral-Grnd
	347/600V Wye 3Ø 4W + Grnd	wietap G S 440 FM UL wietap G S 440 FM UL wietap G S 440 FM UL wietap G S 440 FM UL	L1 Phase-Grnd L2 Phase-Grnd L3 Phase-Grnd Neutral-Grnd
	127/220V Wye 3Ø 4W + Grnd	wietap G S 150 FM UL wietap G S 150 FM UL wietap G S 150 FM UL wietap G S 150 FM UL	L1 Phase-Grnd L2 Phase-Grnd L3 Phase-Grnd Neutral-Grnd
	120/240V High Leg Delta - B High	wietap G S 150 FM UL wietap G S 150 FM UL wietap G S 150 FM UL wietap G S 275 FM UL	L1 Phase-Neutral L3 Phase-Neutral Neutral-Grnd L2 Phase-Neutral
	240/480V High Leg Delta - B High	wietap G S 320 FM UL wietap G S 320 FM UL wietap G S 320 FM UL wietap G S 600 FM UL	L1 Phase-Neutral L3 Phase-Neutral Neutral-Grnd L2 Phase-Neutral
	480V Delta 3Ø 3W + Grnd & HRG Wye	wietap G S 600 FM UL wietap G S 600 FM UL wietap G S 600 FM UL	L1 Phase-Grnd L2 Phase-Grnd L3 Phase-Grnd
	240V Delta 3Ø 3W + Grnd	wietap G S 320 FM UL wietap G S 320 FM UL wietap G S 320 FM UL	L1 Phase-Grnd L2 Phase-Grnd L3 Phase-Grnd
	600V Delta 3Ø 3W + Grnd & HRG	wietap G S WE 600 FM UL wietap G S WE 600 FM UL wietap G S WE 600 FM UL	L1 Phase-Grnd L2 Phase-Grnd L3 Phase-Grnd
	120V Single Phase	wietap G S 150 FM UL	L1 Phase-Neutral
	240V Single Phase	wietap G S 320 FM UL	L1 Phase-Neutral
	127V Single Phase	wietap G S 150 FM UL	L1 Phase-Neutral
	254V Single Phase	wietap G S 320 FM UL	L1 Phase-Neutral
	347V Single Phase	wietap G S 440 FM UL	L1 Phase-Neutral
	277V Single Phase	wietap G S 320 FM UL	L1 Phase-Neutral
	480V Single Phase	wietap G S 600 FM UL	L1 Phase-Neutral
600V Single Phase	wietap G S WE 600 FM UL	L1 Phase-Neutral	
	480V B Corner Grnd Delta 3Ø 3W + Grnd	wietap G S 600 FM UL wietap G S 600 FM UL	L1 Phase-Grnd L3 Phase-Grnd
	240V B Corner Grnd Delta 3Ø 3W + Grnd	wietap G S 320 FM UL wietap G S 320 FM UL	L1 Phase-Grnd L3 Phase-Grnd
	600V B Corner Grnd Delta 3Ø 3W + Grnd	wietap G S WE 600 FM UL wietap G S WE 600 FM UL	L1 Phase-Grnd L3 Phase-Grnd

Overvoltage Protection for **North and Central America**

For the North and Central American region OVP modules have to be used with UL or CSA approval. At the same time the voltage levels are different compared to Europe or the Asian region.

For this reason Wieland offers specialized OVP modules. The green marked countries have energy network systems according UL and CSA mains systems and voltage levels.

The overvoltage protection according IEEE is defined into 3 different areas:

- **Category C (Class I according IEC):** is mainly used at the feed in point of a building or production site. Mainly at outside termination
- **Category B (Class II according IEC):** this category is often used inside of buildings in main distribution panels or in switch board cabinets of machines
- **Category A (Class III according IEC):** is mainly used for the protection of single devices inside a switch board cabinet

Wieland is offering solutions for inside the building. This means for Category B and Category A.

At Category A applications the arrester is connected up front in series to the device.

The rated voltage of the OVP is selected according the nominal voltage of the device which is connected.

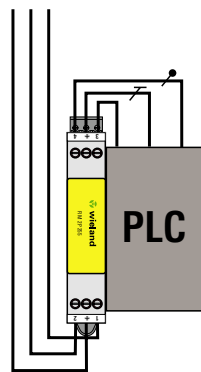

Category A



Single-phase surge arrester, category B & A

For protection of sub-distributions or the control cabinet main supply

wietap G S 150 FM UL wietap G S 275 FM UL

- Surge arrester, type 2, category B
- Multi-purpose surge arrester
- With plug-in protection module
- Thermo Dynamic Control SPD monitoring device
- Small housing
- Operating state/fault indication by indicator flag in window
- With signaling contact (FM)
- Vibration and shock tested according EN 60068-2

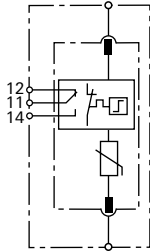

Type	Part No.	Part No.
wietap G S 150 FM UL	84.995.2092.1	
wietap G S 275 FM UL		84.995.2090.1
SPD accord. to EN 61643-11	Type 2	Type 2
SPD accord. to IEC 61643-1	Category B / Class II	Category B / Class II
Maximum continuous voltage AC [U _c]	150 V	275 V
Maximum continuous voltage DC [U _c]	200 V	350 V
Rated varistor voltage AC [U _{mov}]	200 V	350 V
Rated voltage (50/60 Hz) [V]	150 V	275 V
Max. continuous operating voltage [MCOV]	150 V	275 V
Voltage protection rating [VPR]	700 V	1000 V
Rated discharge current [I _n]	20 kA	20 kA
Max. discharge current (8/20) [I _{max}]	40 kA	40 kA
Protection level [U _p]	≤ 0.7 kV	≤ 1.25 kV
Protection level at 5 kA [U _p]	≤ 0.55 kV	≤ 1 kV
Operating time [t _a]	≤ 25 ns	≤ 25 ns
Maximum network overcurrent protection	125 A gL/gG	125 A gL/gG
Short-circuit proof with max. network overcurrent protection	50 kA _{rms}	50 kA _{rms}
TOV-voltage [U _T]	175 V / 5 sec.	335 V / 5 sec.
Temperature range [T _U]		
acc. to UL 1449 3rd edition	0... +85 °C	
acc. to EN 61643-11	-40... +85 °C	
Function/failure indication	green / red	
Wire range (min.)	1.5 mm ² (AWG 14) solid/fine-stranded	
Wire range (max.)	35 mm ² (AWG 2) stranded / 25 mm ² (AWG 4) fine-stranded	
Mounted on DIN rail acc. to EN 60715	35 mm	
Housing material	thermoplastic, UL 94 V-0	
Degree of protection	IP 20	
Dimensions	1 mod., DIN 43880	
Remote signaling contacts (FM)	changeover contact	
Switching capacity AC (FM)	250 V/0.5 A	
Switching capacity DC (FM)	250 V/0.1 A; 125 V/0.2 A; 75 V/0.5 A	
Wire range for remote signaling terminals	max. 1.5 mm ² (AWG 14) solid/fine-stranded	
Approvals		

wietap G S 320 FM UL wietap G S 385 FM UL

- Surge arrester, type 2, category B
- Multi-purpose surge arrester
- With plug-in protection module
- Thermo Dynamic Control SPD monitoring device
- Small housing
- Operating state/fault indication by indicator flag in window
- With signaling contact (FM)
- Vibration and shock tested according EN 60068-2

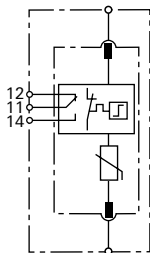

Type	Part No.	Part No.
wietap G S 320 FM UL	84.995.2093.1	
wietap G S 385 FM UL		84.995.2094.1
SPD accord. to EN 61643-11	Type 2	Type 2
SPD accord. to IEC 61643-1	Category B / Class II	Category B / Class II
Maximum continuous voltage AC [U _c]	320 V	385 V
Maximum continuous voltage DC [U _c]	420 V	500 V
Rated varistor voltage AC [U _{mov}]	420 V	500 V
Rated voltage (50/60 Hz) [V]	320 V	385 V
Max. continuous operating voltage [MCOV]	320 V	385 V
Voltage protection rating [VPR]	1200 V	1500 V
Rated discharge current [I _n]	20 kA	20 kA
Max. discharge current (8/20) [I _{max}]	40 kA	40 kA
Protection level [U _p]	≤ 1.5 kV	≤ 1.75 kV
Protection level at 5 kA [U _p]	≤ 1.2 kV	≤ 1.35 kV
Operating time [t _a]	≤ 25 ns	≤ 25 ns
Maximum network overcurrent protection	125 A gL/gG	125 A gL/gG
Short-circuit proof with max. network overcurrent protection	25 kA _{rms}	25 kA _{rms}
TOV-voltage [U _T]	335 V / 5 sec.	385 V / 5 sec.
Temperature range [T _U]		
acc. to UL 1449 3rd edition	0... +85 °C	
acc. to EN 61643-11	-40... +85 °C	
Function/failure indication	green / red	
Wire range (min.)	1.5 mm ² (AWG 14) solid/fine-stranded	
Wire range (max.)	35 mm ² (AWG 2) stranded / 25 mm ² (AWG 4) fine-stranded	
Mounted on DIN rail acc. to EN 60715	35 mm	
Housing material	thermoplastic, UL 94 V-0	
Degree of protection	IP 20	
Dimensions	1 mod., DIN 43880	
Remote signaling contacts (FM)	changeover contact	
Switching capacity AC (FM)	250 V/0.5 A	
Switching capacity DC (FM)	250 V/0.1 A; 125 V/0.2 A; 75 V/0.5 A	
Wire range for remote signaling terminals	max. 1.5 mm ² (AWG 14) solid/fine-stranded	
Approvals		

Single-phase surge arrester, category B & A

For protection of sub-distributions or the control cabinet main supply

wietap G S 440 FM UL wietap G S 600 FM UL

- Surge arrester, type 2, category B
- Multi-purpose surge arrester
- With plug-in protection module
- Thermo Dynamic Control SPD monitoring device
- Small housing
- Operating state/fault indication by indicator flag in window
- With signaling contact (FM)
- Vibration and shock tested according EN 60068-2

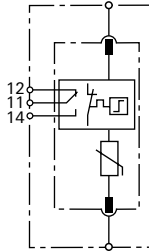

Type	Part No.	Part No.
wietap G S 440 FM UL	84.995.2095.1	
wietap G S 600 FM UL		84.995.2096.1
SPD accord. to EN 61643-11	Type 2	Type 2
SPD accord. to IEC 61643-1	Category B / Class II	Category B / Class II
Maximum continuous voltage AC [U _c]	440 V	600 V
Maximum continuous voltage DC [U _c]	585 V	600 V
Rated varistor voltage AC [U _{mov}]	585 V	600 V
Rated voltage (50/60 Hz) [V]	440 V	600 V
Max. continuous operating voltage [MCOV]	440 V	600 V
Voltage protection rating [VPR]	1500 V	2000 V
Rated discharge current [I _n]	20 kA	20 kA
Max. discharge current (8/20) [I _{max}]	40 kA	30 kA
Protection level [U _p]	≤ 2 kV	≤ 2.5 kV
Protection level at 5 kA [U _p]	≤ 1.7 kV	≤ 2 kV
Operating time [t _a]	≤ 25 ns	≤ 25 ns
Maximum network overcurrent protection	125 A gL/gG	100 A gL/gG
Short-circuit proof with max. network overcurrent protection	25 kA _{rms}	25 kA _{rms}
TOV-voltage [U _T]	580 V / 5 sec.	600 V / 5 sec.
Temperature range [T _U]		
acc. to UL 1449 3rd edition	0... +85 °C	
acc. to EN 61643-11	-40... +85 °C	
Function/failure indication	green / red	
Wire range (min.)	1.5 mm ² (AWG 14) solid/fine-stranded	
Wire range (max.)	35 mm ² (AWG 2) stranded / 25 mm ² (AWG 4) fine-stranded	
Mounted on DIN rail acc. to EN 60715	35 mm	
Housing material	thermoplastic, UL 94 V-0	
Degree of protection	IP 20	
Dimensions	1 mod., DIN 43880	
Remote signaling contacts (FM)	changeover contact	
Switching capacity AC (FM)	250 V/0.5 A	
Switching capacity DC (FM)	250 V/0.1 A; 125 V/0.2 A; 75 V/0.5 A	
Wire range for remote signaling terminals	max. 1.5 mm ² (AWG 14) solid/fine-stranded	
Approvals		

wietap G S WE 600 FM UL

- Surge arrester, type 2, category B
- Multi-purpose surge arrester
- With plug-in protection module
- Thermo Dynamic Control SPD monitoring device
- Small housing
- Operating state/fault indication by indicator flag in window
- With signaling contact (FM)
- Vibration and shock tested according EN 60068-2

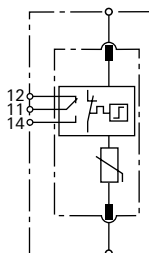

Type	Part No.	Part No.
wietap G S WE 600 FM UL	84.995.2097.1	
SPD accord. to EN 61643-11	Type 2	
SPD accord. to IEC 61643-1	Category B / Class II	
Maximum continuous voltage AC [U _c]	600 V	
Maximum continuous voltage DC [U _c]	600 V	
Rated varistor voltage AC [U _{mov}]	750V	
Rated voltage (50/60 Hz) [V]	600 V	
Max. continuous operating voltage [MCOV]	750 V	
Voltage protection rating [VPR]	2500V	
Rated discharge current [I _n]	10 kA	
Max. discharge current (8/20) [I _{max}]	25 kA	
Protection level [U _p]	≤ 3 kV	
Protection level at 5 kA [U _p]	≤ 2.5 kV	
Operating time [t _a]	≤ 25 ns	
Maximum network overcurrent protection	100 A gL/gG	
Short-circuit proof with max. network overcurrent protection	25 kA _{rms}	
TOV-voltage [U _T]	900 V / 5 sec.	
Temperature range [T _U]		
acc. to UL 1449 3rd edition	0... +85 °C	
acc. to EN 61643-11	-40... +85 °C	
Function/failure indication	green / red	
Wire range (min.)	1.5 mm ² (AWG 14) solid/fine-stranded	
Wire range (max.)	35 mm ² (AWG 2) stranded / 25 mm ² (AWG 4) fine-stranded	
Mounted on DIN rail acc. to EN 60715	35 mm	
Housing material	thermoplastic, UL 94 V-0	
Degree of protection	IP 20	
Dimensions	1 mod., DIN 43880	
Remote signaling contacts (FM)	changeover contact	
Switching capacity AC (FM)	250 V/0.5 A	
Switching capacity DC (FM)	250 V/0.1 A; 125 V/0.2 A; 75 V/0.5 A	
Wire range for remote signaling terminals	max. 1.5 mm ² (AWG 14) solid/fine-stranded	
Approvals		

Surge arrester, category A

For direct load protection in control cabinets or sub-distributions

wietap R M 2P 30 FM

- Surge arrester, type 3
- Two-pole surge arrester
- High discharge capacity due to powerful zinc oxide varistor
- Slim design (modular construction) acc. to DIN 43880
- With pluggable protection modules
- Function/failure indication according to VDE 0100-534
- With remote signaling contact (FM)
- Vibration and shock tested acc. to EN 60068-2

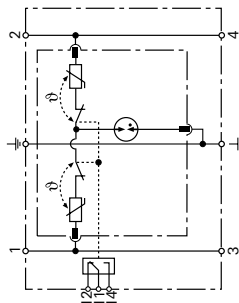

Type	Part No.
wietap R M 2P 30 FM	84.995.3206.0
Technical Data	
SPD accord. to EN 61643-11	Type 3
SPD accord. to IEC 61643-1	Category A / Class III
Rated voltage (50/60 Hz) [V]	24 V
Maximum continuous voltage AC [U _c]	30 V
Maximum continuous voltage DC [U _c]	30 V
Max. continuous operating voltage [MCOV]	30 V
Voltage protection rating [VPR]	330 V
Rated current AC acc. UL 1449 3rd edition EN 61643-11	20 A 25 A
Rated discharge current (8/20) [I _n]	1 kA
Total discharge current (8/20) [L+N-PE] [I _{total}]	2 kA
Combined surge [U _{oc}]	2 kV
Combined surge [L+N-PE] [U _{oc total}]	4 kV
Protection level [L-N] [U _p]	≤ 180 V
Protection level [L/N-PE] [U _p]	≤ 630 V
Operating time [L-N] [t _A]	≤ 25 ns
Operating time [L/N-PE] [t _A]	≤ 100 ns
Maximum network overcurrent protection	25 A gL/gG or B 25 A
Short-circuit proof with network overcurrent protection with 25 A gL/gG	6 kA _{rms}
Temperature range [T _U]	acc. to UL 1449 3rd edition acc. to EN 61643-11
Function/failure indication	green / red
Wire range (min.)	0.5 mm ² (AWG 20) solid/fine-stranded
Wire range (max.)	4 mm ² (AWG 12) solid / 2.5 mm ² (AWG 14) fine-stranded
Mounted on DIN rail acc. to EN 60715	35 mm
Housing material	thermoplastic, UL 94 V-0
Degree of protection	IP 20
Dimensions	1 mod., DIN 43880
Remote signaling contacts (FM)	changeover contact
Switching capacity AC (FM)	250 V/0.5 A
Switching capacity DC (FM)	250 V/0.1 A; 125 V/0.2 A; 75 V/0.5 A
Wire range for remote signaling terminals	max. 1.5 mm ² (AWG 16) solid/fine-stranded
Approvals	CE

wietap R M 2P 150 FM

- Surge arrester, type 3
- Two-pole surge arrester
- High discharge capacity due to powerful zinc oxide varistor
- Slim design (modular construction) acc. to DIN 43880
- With pluggable protection modules
- Function/failure indication according to VDE 0100-534
- With remote signaling contact (FM)
- Vibration and shock tested acc. to EN 60068-2

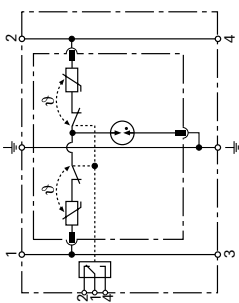

Type	Part No.
wietap R M 2P 150 FM	84.995.3209.0
Technical Data	
SPD accord. to EN 61643-11	Type 3
SPD accord. to IEC 61643-1	Category A / Class III
Rated voltage (50/60 Hz)	120 V
Maximum continuous voltage AC [U _c]	150 V
Maximum continuous voltage DC [U _c]	150 V
Max. continuous operating voltage [MCOV]	150 V
Voltage protection rating [VPR]	700 V
Rated current AC acc. UL 1449 3rd edition EN 61643-11	20 A 25 A
Rated discharge current (8/20) [I _n]	2 kA
Total discharge current (8/20) [L+N-PE] [I _{total}]	4 kA
Combined surge [U _{oc}]	4 kV
Combined surge [L+N-PE] [U _{oc total}]	8 kV
Protection level [L-N] [U _p]	≤ 640 V
Protection level [L/N-PE] [U _p]	≤ 800 V
Operating time [L-N] [t _A]	≤ 25 ns
Operating time [L/N-PE] [t _A]	≤ 100 ns
Maximum network overcurrent protection	25 A gL/gG or B 25 A
Short-circuit proof with network overcurrent protection with 25 A gL/gG	6 kA _{rms}
Temperature range [T _U]	acc. to UL 1449 3rd edition acc. to EN 61643-11
Function/failure indication	green / red
Wire range (min.)	0.5 mm ² (AWG 20) solid/fine-stranded
Wire range (max.)	4 mm ² (AWG 12) solid / 2.5 mm ² (AWG 14) fine-stranded
Mounted on DIN rail acc. to EN 60715	35 mm
Housing material	thermoplastic, UL 94 V-0
Degree of protection	IP 20
Dimensions	1 mod., DIN 43880
Remote signaling contacts (FM)	changeover contact
Switching capacity AC (FM)	250 V/0.5 A
Switching capacity DC (FM)	250 V/0.1 A; 125 V/0.2 A; 75 V/0.5 A
Wire range for remote signaling terminals	max. 1.5 mm ² (AWG 14) solid/fine-stranded
Approvals	CE

Surge arrester, category A

For direct load protection in control cabinets or sub-distributions

wietap R M 2P 255

- Surge arrester, type 3
- Two-pole surge arrester
- High discharge capacity due to powerful zinc oxide varistor
- Slim design (modular construction) acc. to DIN 43880
- With pluggable protection modules
- Function/failure indication according to VDE 0100-534
- Vibration and shock tested acc. to EN 60068-2

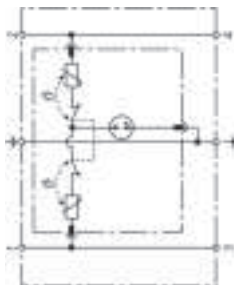

Type	Part No.
wietap R M 2P 255	84.995.3200.0
Technical Data	
SPD accord. to EN 61643-11	Type 3
SPD accord. to IEC 61643-1	Category A / Class III
Rated voltage (50/60 Hz) [V]	240 V
Maximum continuous voltage AC [U _c]	255 V
Maximum continuous voltage DC [U _c]	255 V
Max. continuous operating voltage [MCOV]	255 V
Voltage protection rating [VPR]	1200 V
Rated current AC	20 A
Rated discharge current (8/20) [I _n]	3 kA
Total discharge current (8/20) [L+N-PE] [I _{total}]	5 kA
Combined surge [U _{oc}]	6 kV
Combined surge [L+N-PE] [U _{oc total}]	10 kV
Protection level [L-N] [U _p]	≤ 1250 V
Protection level [L/N-PE] [U _p]	≤ 1500 V
Operating time [L-N] [t _Δ]	≤ 25 ns
Operating time [L/N-PE] [t _Δ]	≤ 100 ns
Maximum network overcurrent protection	25 A gL/gG or B 25 A
Short-circuit proof with network overcurrent protection with 25 A gL/gG	6 kA _{rms}
TOV-voltage [L-N] [U _T]	335 V / 5 sec.
TOV-voltage [L/N-PE] (I) [U _T]	400 V / 5 sec.
TOV-voltage [L+N-PE] (II) [U _T]	1200 V + UCS / 200 ms
Temperature range [T _u]	
acc. to UL 1449 3rd edition	0... +85 °C
acc. to EN 61643-11	-40... +85 °C
Function/failure indication	green / red
Wire range (min.)	0.5 mm ² (AWG 20) solid/fine-stranded
Wire range (max.)	4 mm ² (AWG 12) solid / 2.5 mm ² (AWG 14) fine-stranded
Mounted on DIN rail acc. to EN 60715	35 mm
Housing material	thermoplastic, UL 94 V-0
Degree of protection	IP 20
Dimensions	1 mod., DIN 43880
Approvals	CE

wietap R M 2P 255 FM

- Surge arrester, type 3
- Two-pole surge arrester
- High discharge capacity due to powerful zinc oxide varistor
- Slim design (modular construction) acc. to DIN 43880
- With pluggable protection modules
- Function/failure indication according to VDE 0100-534
- With remote signaling contact (FM)
- Vibration and shock tested acc. to EN 60068-2

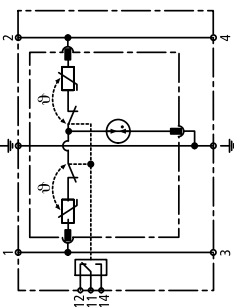

Type	Part No.
wietap R M 2P 255 FM	84.995.3205.0
Technical Data	
SPD accord. to EN 61643-11	Type 3
SPD accord. to IEC 61643-1	Category A / Class III
Rated voltage (50/60 Hz) [V]	240 V
Maximum continuous voltage AC [U _c]	255 V
Maximum continuous voltage DC [U _c]	255 V
Max. continuous operating voltage [MCOV]	255 V
Voltage protection rating [VPR]	1200 V
Rated current AC acc. UL 1449 3rd edition EN 61643-11	20 A 25 A
Rated discharge current (8/20) [I _n]	3 kA
Total discharge current (8/20) [L+N-PE] [I _{total}]	5 kA
Combined surge [U _{oc}]	6 kV
Combined surge [L+N-PE] [U _{oc total}]	10 kV
Protection level [L-N] [U _p]	≤ 1250 V
Protection level [L/N-PE] [U _p]	≤ 1500 V
Operating time [L-N] [t _Δ]	≤ 25 ns
Operating time [L/N-PE] [t _Δ]	≤ 100 ns
Maximum network overcurrent protection	25 A gL/gG or B 25 A
Short-circuit proof with network overcurrent protection with 25 A gL/gG	6 kA _{rms}
TOV-voltage [L-N] [U _T]	335 V / 5 sec.
TOV-voltage [L/N-PE] (I) [U _T]	400 V / 5 sec.
TOV-voltage [L+N-PE] (II) [U _T]	1200 V + UCS / 200 ms
Temperature range [T _u]	
acc. to UL 1449 3rd edition	0... +85 °C
acc. to EN 61643-11	-40... +85 °C
Function/failure indication	green / red
Wire range (min.)	0.5 mm ² (AWG 20) solid/fine-stranded
Wire range (max.)	4 mm ² (AWG 12) solid / 2.5 mm ² (AWG 14) fine-stranded
Mounted on DIN rail acc. to EN 60715	35 mm
Housing material	thermoplastic, UL 94 V-0
Degree of protection	IP 20
Dimensions	1 mod., DIN 43880
Remote signaling contacts (FM)	changeover contact
Switching capacity AC (FM)	250 V/0.5 A
Switching capacity DC (FM)	250 V/0.1 A; 125 V/0.2 A; 75 V/0.5 A
Wire range for remote signaling terminals	max. 1.5 mm ² (AWG 16) solid/fine-stranded
Approvals	CE

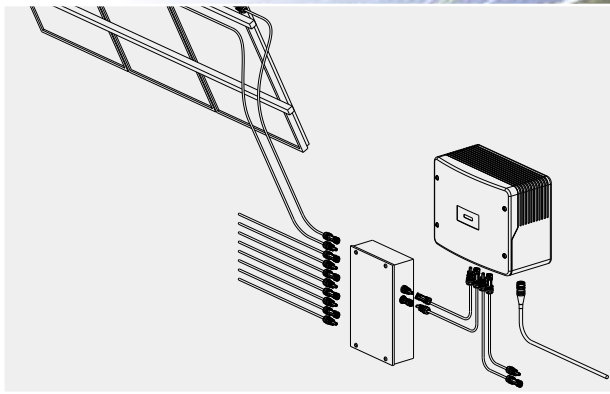

Overvoltage protection for Photovoltaic systems

Photovoltaic systems, abbreviated as PV systems, are a considerable investment that must be protected from failure and damage. As these systems are installed outdoors, they are exposed to the danger of overvoltage from lightning strikes.

Overvoltage protection in the DC circuit with central inverters

The generator circuit (the PV modules) produces a direct current. Connecting the PV modules and arrays in series allows voltages of 1000 V to be reached. This combination with the fact that the generator circuit can continue to supply energy after overvoltage requires sophisticated technology for the overvoltage arrester.

DC overvoltage protection:

The PV/DC overvoltage arresters are specially designed for use in PV systems.

Both the housing technology and the connections are designed for the requirements of a PV systems high voltages and conductor cross-sections. With a width of only 36 or 48mm, the units are easily installed inside distribution panels, requiring the minimum of space.

- High discharge capacity due to powerful zinc-oxide varistor
- No fire hazard caused by permanent electric arc due to combined disconnect and short-circuit facility. Overload indicated in display window
- Signaling contacts for remote monitoring in all remote signaling types

AC overvoltage protection:

On the AC side of the inverters overvoltage protection must also be installed. The arresters listed here are the most commonly used versions.

Suitable units can be found inside the chapters **wietap** IEC and **wietap** UL/CSA.



Surge protection for solar modules

To be used in photovoltaic DC circuits

wietap GS PV SCI 600 (FM)

- DC solar arrester for 600 V string voltage
- For DC grounded solar systems
- No fire hazard during overload due to combined disconnection and short-circuit device
- Safe, arc-free replacement of protection modules due to integrated DC fuse
- High discharge capacity
- Function/failure indication
- **wietap** GS PV SCI 600 FM with remote signaling contact (FM)

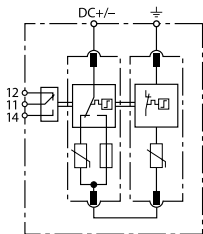

Type	Part No.
wietap GS PV SCI 600	84.995.2550.0
wietap GS PV SCI 600 FM	84.995.2555.0
Technical Data	
Connection between	DC – Grnd
Conformity according	prEN 50539-11
SPD-accord. to EN 61643-11	Type 2
SPD-accord. to IEC 61643-1	Class II
Maximum PV voltage [UPV _{max}]	≤ 600 V
Protection level [U _P]	≤ 2.5 kV
Protection level at 5 kA [U _P]	≤ 2 kV
Nominal discharge current (8/20) [(DC+/DC-) → PE] [I _n]	12.5 kA
Max. discharge current (8/20) [(DC+/DC-) → PE] [I _{max}]	25 kA
Operating time [t _A]	≤ 25 ns
Temperature range [T _U]	-40 ... +80 °C
Short-circuit resistance (I _{SCWPV})	1000 A
Function/failure indication	green / red
Wire range (min.)	1.5 mm ² (AWG 14) solid/fine-stranded
Wire range (max.)	35 mm ² (AWG 2) stranded / 25 mm ² (AWG 4) fine-stranded
Mounted on DIN rail acc. to EN 60715	35 mm
Housing material	Thermoplast, UL 94 V-0
Degree of protection	IP 20
Dimensions	2 TE, DIN 43880 (36 mm)
Remote signaling contacts (FM)	Change-over contact
Switching capacity AC (FM)	250 V/0.5 A
Switching capacity DC (FM)	250 V/0.1 A; 125 V/0.2 A; 75 V/0.5 A
Wire range for remote signaling terminals	max. 1.5 mm ² (AWG 14) solid/fine-stranded
Approvals	CE

Surge protection for solar modules

To be used in photovoltaic DC circuits

wietap GM YPV SCI 600 (FM)

- DC solar arrester for 600 V string voltage
- No fire hazard during overload due to combined disconnection and short-circuit device
- Safe, arc-free replacement of protection modules due to integrated DC fuse
- High discharge capacity
- Function/failure indication
- **wietap** GM YPV SCI 600 FM with remote signaling contact (FM)

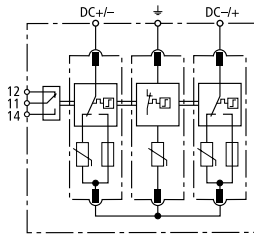

Type	Part No.
wietap GM YPV SCI 600	84.995.2511.0
wietap GM YPV SCI 600 FM	84.995.2516.0
Repl. module "+" or "-" against int. neutral point	84.995.2053.0
Repl. module int. neutral point against \pm	84.995.2010.0
Technical Data	
Connection between	DC+ – Grnd – DC-
Conformity according	prEN 50539-11
SPD-accord. to EN 61643-11	Type 2
SPD-accord. to IEC 61643-1	Class II
Maximum PV voltage [UPV _{max}]	≤ 600 V
Protection level [U _p]	≤ 2.5 kV
Protection level at 5 kA [U _p]	≤ 2 kV
Total discharge current (8/20) [I _{total}]	40 kA
Nominal discharge current (8/20) [(DC+/DC-) → PE] [I _n]	12.5 kA
Max. discharge current (8/20) [(DC+/DC-) → PE] [I _{max}]	25 kA
Operating time [t _A]	≤ 25 ns
Temperature range [T _v]	-40 ... +80 °C
Short-circuit resistance [I _{SCWPV}]	1000 A
Function/failure indication	green / red
Wire range (min.)	1.5 mm ² (AWG 14) solid/fine-stranded
Wire range (max.)	35 mm ² (AWG 2) stranded / 25 mm ² (AWG 4) fine-stranded
Mounted on DIN rail acc. to EN 60715	35 mm
Housing material	Thermoplast, UL 94 V-0
Degree of protection	IP 20
Dimensions	3 TE, DIN 43880 (54 mm)
Remote signaling contacts (FM)	Change-over contact
Switching capacity AC (FM)	250 V/0.5 A
Switching capacity DC (FM)	250 V/0.1 A; 125 V/0.2 A; 75 V/0.5 A
Wire range for remote signaling terminals	max. 1.5 mm ² (AWG 14) solid/fine-stranded
Approvals	CE

Replacement module for wietap GM YPV SCI 600 (FM)

wietap G MOD PV SCI 300

"+" or "-" against internal neutral point

wietap G MOD 275

Internal neutral point against PE

Type	Part No.
wietap G MOD PV SCI 300	84.995.2053.0
wietap G MOD 275	84.995.2010.0

Surge protection for solar modules

To be used in photovoltaic DC circuits

wietap GM YPV SCI 1000 (FM)

- DC solar arrester for 1000 V string voltage
- No fire hazard during overload due to combined disconnection and short-circuit device
- Safe, arc-free replacement of protection modules due to integrated DC fuse
- High discharge capacity
- Function/failure indication
- **wietap** GM YPV SCI 1000 FM with remote signaling contact (FM)

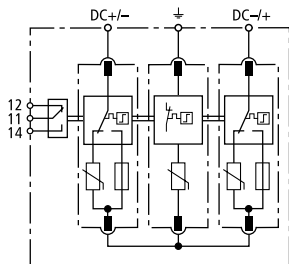

Type	Part No.
wietap GM YPV SCI 1000	84.995.2510.0
wietap GM YPV SCI 1000 FM	84.995.2515.0
Repl. module "+" or "-" against int. neutral point	84.995.2051.0
Repl. module int. neutral point against \oplus	84.995.2015.0
Technical Data	
Connection between	DC+ – Grnd – DC-
Conformity according	prEN 50539-11
SPD-accord. to EN 61643-11	Type 2
SPD-accord. to IEC 61643-1	Class II
Maximum PV voltage [UPV _{max}]	≤ 1000 V
Protection level [U _P]	≤ 4 kV
Protection level at 5 kA [U _P]	≤ 3.5 kV
Total discharge current (8/20) [I _{total}]	40 kA
Nominal discharge current (8/20) [(DC+/DC-) → PE] [I _n]	12.5 kA
Max. discharge current (8/20) [(DC+/DC-) → PE] [I _{max}]	25 kA
Operating time [t _A]	≤ 25 ns
Temperature range [T _U]	-40 ... +80 °C
Short-circuit resistance (I _{scWPV})	1000 A
Function/failure indication	green / red
Wire range (min.)	1.5 mm ² (AWG 14) solid/fine-stranded
Wire range (max.)	35 mm ² (AWG 2) stranded / 25 mm ² (AWG 4) fine-stranded
Mounted on DIN rail acc. to EN 60715	35 mm
Housing material	Thermoplast, UL 94 V-0
Degree of protection	IP 20
Dimensions	3 TE, DIN 43880 (54 mm)
Remote signaling contacts (FM)	Change-over contact
Switching capacity AC (FM)	250 V/0.5 A
Switching capacity DC (FM)	250 V/0.1 A; 125 V/0.2 A; 75 V/0.5 A
Wire range for remote signaling terminals	max. 1.5 mm ² (AWG 14) solid/fine-stranded
Approvals	CE

Replacement module for wietap GM YPV SCI 1000 (FM)

wietap G MOD PV SCI 500

"+" or "-" against internal neutral point

wietap G MOD 440

Internal neutral point against PE

Type	Part No.
wietap G MOD PV SCI 500	84.995.2051.0
wietap G MOD 440	84.995.2015.0

Surge protection for solar modules

To be used in photovoltaic DC circuits

AC arrester on mains for Class 1/2/3



The used arrester type of the AC side is depending on the mains system.

A suitable arrester with the relevant certifications can be found in the previous chapters.



The suitable distribution for your project



AC combiner box



DC combiner box

Housing

Protection	Class II
UV-resistant	yes
Material	polycarbonate
Cable connection	pluggable or gland

Build in components

- Termination points for solar connectors
- Big termination points for inverter connection
- PE connection
- String fusing
- Reverse current diodes
- String monitoring
- Main switch
- Circuit breaker
- Overvoltage protection and many more

Wieland will support you during the planning phase. High product quality and documentation are a standard for us.

More information and a planning tool can be found in the brochure **gesis** SOLAR, Part No. 0164.0, and at <http://solar.gesis.wieland-electric.de>















wipos Power supply units

Pure Power. No-Frills.

Power supplies perform a central function in the control cabinet. Their reliability affects the availability of the machine or the process to a great degree. That is why a robust and proven design is very important for a power supply unit. There are no unnecessary frills with the **wipos** family. Instead, these power supply units score with their fundamental features.

wipos satisfies your requirements in the significant disciplines:

- | | |
|--|---|
|  100% power up to 60°C |  Can be connected in parallel (from 5 A) to increase power and redundancy |
|  Automatic or wide-input voltage range for worldwide use |  High operational reliability due to long hold-up times >30 ms |
|  PFC-technology for high functional reliability |  Compensation of voltage drops via adjustable output voltage |
|  Outdoor installation possible due to wide temperature range |  Easy to commission via LED diagnosis |
|  Active monitoring with signalling contact |  For mounting on DIN Rail TS 35 / TS 32 |



wipos P1 Modules

Power supply wipos
P1 24-1.25
P1 24-2.5



Type	Part No.	Part No.
wipos P1 24-1.25	81.000.6110.0	
wipos P1 24-2.5		81.000.6120.0
Technical Data		
Input voltage	85 – 264 V AC, 90 – 375 V DC	
PFC	not necessary	not necessary
Hold up time	> 30 ms at 230 V	> 30 ms at 230 V
Output voltage	24 – 28 V	24 – 28 V
Output current	1.25 A	2.5 A
Parallel operation	no	no
In series connectable	yes	yes
Temperature range	-40 ... +70 °C	-40 ... +70 °C
Derating	>60 °C	> 60 °C
Signal contact	yes	yes
Dimensions (mm) W x H x D	40.5 x 90 x 114	40.5 x 90 x 114
Weight	290 g	360 g
Type of connectors	Screw terminal	Screw terminal
Connector size	0.2 – 2.5 mm ² (AWG 24 – 14)	0.2 – 2.5 mm ² (AWG 24 – 14)
Efficiency	83 – 86 %	86 – 89 %
Approvals	CE, UL 1310 Class 2 Haz. Class I Div.2	CE, UL 1310 Class 2 Haz. Class I Div.2

Power supply wipos
P1 24-3.8
P1 24-5



Type	Part No.	Part No.
wipos P1 24-3.8	81.000.6135.0	
wipos P1 24-5		81.000.6130.0
Technical Data		
Input voltage	115/230V AC auto, 210 – 375 V DC	
PFC	yes	yes
Hold up time	> 30 ms at 230 V	> 30 ms at 230 V
Output voltage	22.5 – 24,5 V	22.5 – 28.5 V
Output current	3.8 A	5 A
Parallel operation	no	yes (up to 3)
In series connectable	yes	yes
Temperature range	-35 ... +70 °C	-35 ... +70 °C
Derating	> 60 °C	> 60 °C
Signal contact	yes	yes
Dimensions (mm) W x H x D	64 x 124.5 x 123.6	64 x 124.5 x 123.6
Weight	920 g	920 g
Type of connectors	Screw terminal	Screw terminal
Connector size	0.5 – 6 mm ² (AWG 22 – 10)	0.5 – 6 mm ² (AWG 22 – 10)
Efficiency	83 – 85 %	84 – 86 %
Approvals	CE, UL 1310 Class 2 Haz. Class I Div.2	CE, Haz. Class I Div.2

Power supply wipos
P1 24-10
P1 24-20



Type	Part No.	Part No.
wipos P1 24-10	81.000.6140.0	
wipos P1 24-20		81.000.6150.0
Technical Data		
Input voltage	115/230V AC auto, 210–375V DC	115/230V AC auto 120–370V DC
PFC	yes	yes
Hold up time	> 30 ms at 230 V	> 30 ms at 230 V
Output voltage	22.5 – 28.5 V	22.5 – 28.5 V
Output current	10 A	20 A
Parallel operation	yes (up to 3)	yes (up to 3)
In series connectable	yes	yes
Temperature range	-40 ... +70 °C	-40 ... +70 °C
Derating	> 60 °C	> 55 °C
Signal contact	yes	yes
Dimensions (mm) W x H x D	83.5 x 124.5 x 123.6	175.5 x 124.5 x 123.6
Weight	1300 g	1920 g
Type of connectors	Screw terminal	Screw terminal
Connector size	0.5 – 6 mm ² (AWG 22 – 10)	0.5 – 6 mm ² (AWG 22 – 10)
Efficiency	87 – 89 %	86 – 89 %
Approvals	CE, Haz. Class I Div.2	CE, Haz. Class I Div.2

wipos P1 Modules

Power supply *wipos* P1 12-5



Type	Part No.
wipos P1 12-5	81.000.6132.0
Technical Data	
Input voltage	85 – 264 V AC, 90 – 375 V DC
PFC	not necessary
Hold up time	>30 ms at 230 V
Output voltage	12 – 14 V
Output current	5 A
Parallel operation	no
In series connectable	yes
Temperature range	-40 ... +70 °C
Derating	>61 °C
Signal contact	no
Dimensions (mm) W x H x D	40,5 x 90 x 114
Weight	340 g
Type of connectors	Screw terminal
Connector size	0.2 – 2.5 mm ² (AWG 24 – 14)
Efficiency	86 %
Approvals	CE Haz. Class I Div.2

Power supply *wipos* P1 12-10



Type	Part No.
wipos P1 12-10	81.000.6142.0
Technical Data	
Input voltage	115/230V AC auto, 210 – 375 V DC
PFC	not necessary
Hold up time	>30 ms at 230 V
Output voltage	11,4 – 14,5 V
Output current	10 A
Parallel operation	yes (up to 3)
In series connectable	yes
Temperature range	-35 ... +70 °C
Derating	>61 °C
Signal contact	no
Dimensions (mm) W x H x D	64 x 124.5 x 123.6
Weight	920 g
Type of connectors	Screw terminal
Connector size	0.5 – 6 mm ² (AWG 22 – 10)
Efficiency	84 %
Approvals	CE Haz. Class I Div.2

Power supply *wipos* P1 48-5



Type	Part No.
wipos P1 48-5	81.000.6134.0
Technical Data	
Input voltage	115/230 V AC auto, 210 – 375 V DC
PFC	not necessary
Hold up time	>30 ms at 230 V
Output voltage	47 – 56 V
Output current	5 A
Parallel operation	yes (up to 3)
In series connectable	yes
Temperature range	-40 ... +70 °C
Derating	>61 °C
Signal contact	no
Dimensions (mm) W x H x D	83.5 x 124.5 x 123.6
Weight	1380 g
Type of connectors	Screw terminal
Connector size	0.5 – 6 mm ² solid/fine str. (AWG 22 – 10)
Efficiency	90 %
Approvals	CE Haz. Class I Div.2



wipos P3 Modules

Power supply *wipos* P3 24-5 P3 24-10



Type	Part No.	Part No.
wipos P3 24-5	81.000.6160.0	
wipos P3 24-10		81.000.6170.0
Technical Data		
Input voltage	340 – 575VAC 480 – 820VDC	340 – 575VAC 480 – 820VDC
PFC	yes (0.55)	yes (0.6)
Hold up time	20 ms	20 ms
Output voltage	22.5 – 28.5 V	22.5 – 28.5 V
Output current	5 A	10 A
Parallel operation	yes (up to 2)	yes (up to 2)
In series connectable	yes	yes
Temperature range	-40 ... +70 °C	-40 ... +70 °C
Derating	>60 °C	>60 °C
Signal contact	yes	yes
Dimensions (mm) W x H x D	75 x 124 x 119	89 x 124 x 119
Weight	800 g	1100 g
Type of connectors	Screw terminal	Screw terminal
Connector size	to 6 mm ² (AWG 10)	to 6 mm ² (AWG 10)
Efficiency	88 – 90 %	88 – 90 %
Approvals	CE Haz. Class I Div.2	CE Haz. Class I Div.2

Power supply *wipos* P3 24-20



Type	Part No.
wipos P3 24-20	81.000.6180.0
Technical Data	
Input voltage	340 – 575VAC 480 – 820VDC
PFC	yes (0.7)
Hold up time	20 ms
Output voltage	22.5 – 28.5 V
Output current	20 A
Parallel operation	yes (up to 2)
In series connectable	yes
Temperature range	-30 ... +70 °C
Derating	>60 °C
Signal contact	yes
Dimensions (mm) W x H x D	150 x 124 x 119
Weight	1750 g
Type of connectors	Screw terminal
Connector size	to 6 mm ² (AWG 10)
Efficiency	88 – 90 %
Approvals	CE Haz. Class I Div.2

Power supply *wipos* P3 24-40



Type	Part No.
wipos P3 24-40	81.000.6190.0
Technical Data	
Input voltage	340 – 575VAC 480 – 820VDC
PFC	yes (0.7)
Hold up time	15 ms
Output voltage	22.5 – 28.5 V
Output current	40 A
Parallel operation	yes (up to 2)
In series connectable	yes
Temperature range	-40 ... +70 °C
Derating	>60 °C
Signal contact	yes
Dimensions (mm) W x H x D	276 x 127 x 119
Weight	3200 g
Type of connectors	Screw terminal
Connector size	to 6 mm ² (AWG 10)/ output to 16 mm ² (AWG 6)
Efficiency	90 – 92 %
Approvals	CE Haz. Class I Div.2

Further Modules available on request.

wipos Modules

Redundancy module *wipos* R20



Type	Part No.
wipos R20	81.000.6200.0
Technical Data	
Input voltage	21 – 28 V DC
Input current	20 A (in total)
Output current	20 A
Typical voltage drop	0.5 V
Temperature range	-40 ... +70 °C
Signal contact	one each for channel A and B
Signal contact	1 A at 30 V DC
Display/Relay OK	Input voltage 20...30 V (+/-5 %)
Display/Relay fail	Input voltage <20 V or >30 V (+/-5 %)
Dimensions (mm) W x H x D	54 x 90 x 114
Weight	210 g
Type of connectors	Screw terminal
Connector size	0.2 – 2.5 mm ² (AWG 24–12)
Connector size for signal contacts	0.2 – 1.5 mm ² (AWG 24–14)
Approvals	CE

Fusing module *wipos* FM 4-10



Type	Part No.
wipos FM 4-10	81.000.6210.0
Technical Data	
Input voltage	18 – 30 V
Output current via all 4 fuses	40 A max.
Output voltage	24 V (equivalent to input voltage)
Number of fusing circuits	4
Nominal current of fuse	max. 10 A (check power losses of fuse)
Fuses	4 x G-fuse holder 5 x 20 mm
LED	one per fuse, LED lights whe fuse is broken
Alarm contact	yes
Temperature range	0 ... +60 °C
Dimensions (mm) W x H x D	48 x 96 x 68
Mounting type	DIN rail mounting
Weight	110 g
Type of connectors	Screw terminal
Connector size input	10 mm ² (AWG 8)
Connector size output	up to 4 mm ² (AWG 12) solid, 2.5 mm ² (AWG 14) fine-stranded
Approvals	CE

Uninterrupted power supply *wipos* UPS 24-30



Type	Part No.
wipos UPS 24-30	81.000.6220.0
Technical Data	
Rated input voltage U _{IN}	24 V DC
Input current	max. 35 A
Rated output voltage U _{OUT}	24 V DC
Output current I _{OUT}	max. 30 A
Output voltage (battery mode)	18.7 – 28.0 V
Output current (battery mode)	max. 30 A
Temperature range	-40 ... +70 °C
Derating	> 51 °C
Signal contact mains or battery current	yes
Signal contact discharge battery	yes
Signal contact broken battery	yes
Battery type	Lead-acid or lead-gel
Battery size	2 ... 12 Ah / 2 x 12 V
Dimensions (mm) W x H x D	54 x 90 x 114
Weight	370 g
Type of connectors	Screw terminal
Connector size	0.2–4 mm ² (AWG 24–12)
Approvals	CE



wipos PB1 Modules

Power supply wipos
PB1 5-1.5
PB1 5-3



Type	Part No.	Part No.
wipos PB1 5-1.5	81.000.6321.0	
wipos PB1 5-3		81.000.6331.0
Technical Data		
Input voltage	90 – 264 V AC, 120 – 375 V DC	90 – 264 V AC, 120 – 375 V DC
PFC	not necessary	not necessary
Hold up time	> 30 ms at 230 V	> 80 ms at 230 V
Output voltage	5 V	5 – 5.5 V
Output current	1.5 A	3 A
Temperature range	-40 ... +70 °C	-40 ... +70 °C
Derating	> 61 °C	> 61 °C
LED display	yes	yes
Dimensions W x H x D	18 x 91 x 57	35 x 91 x 57
Installation dimensions	for junction boxes and flat control panels	for junction boxes and flat control panels
Mounting type	DIN rail mounting	DIN rail mounting
Weight	65 g	130 g
Type of connectors	Screw terminal	Screw terminal
Connector size	0.2 – 2.5 mm ² (AWG 24 – 14)	0.2 – 2.5 mm ² (AWG 24 – 14)
Efficiency	74 %	82 %
Approvals	CE UL 1310 Class 2 Haz. Class I Div.2	CE UL 1310 Class 2

Power supply wipos
PB1 12-0.83
PB1 24-0.42



Type	Part No.	Part No.
wipos PB1 12-0.83	81.000.6302.0	
wipos PB1 24-0.42		81.000.6300.0
Technical Data		
Input voltage	90 – 264 V AC, 120 – 375 V DC	90 – 264 V AC, 120 – 375 V DC
PFC	not necessary	not necessary
Hold up time	> 30 ms at 230 V	> 30 ms at 230 V
Output voltage	12 V	24 – 28 V
Output current	0.83 A	0.42 A
Temperature range	-40 ... +70 °C	-25 ... +70 °C
Derating	> 61 °C: 100 %, 70 °C: 75 %	> 60 °C
LED display	yes	yes
Dimensions W x H x D	18 x 91 x 57	18 x 91 x 57
Installation dimensions	for junction boxes and flat control panels	for junction boxes and flat control panels
Mounting type	DIN rail mounting	DIN rail mounting
Weight	65 g	65 g
Type of connectors	Screw terminal	Screw terminal
Connector size	0.2 – 2.5 mm ² (AWG 24 – 14)	0.2 – 2.5 mm ² (AWG 24 – 14)
Efficiency	78 %	80 %
Approvals	CE Haz. Class I Div.2	CE UL 1310 Class 2 Haz. Class I Div.2

Power supply wipos
PB1 12-2
PB1 24-1



Type	Part No.	Part No.
wipos PB1 12-2	81.000.6322.0	
wipos PB1 24-1		81.000.6310.0
Technical Data		
Input voltage	90 – 264 V AC, 120 – 375 V DC	90 – 264 V AC, 120 – 375 V DC
PFC	not necessary	not necessary
Hold up time	> 80 ms at 230 V	> 80 ms at 230 V
Output voltage	12 – 14 V	24 – 28 V
Output current	2 A	1 A
Temperature range	-40 ... +70 °C	-25 ... +70 °C
Derating	> 61 °C: 100 %, 70 °C: 75 %	> 60 °C
LED display	yes	yes
Dimensions W x H x D	35 x 91 x 57	35 x 91 x 57
Installation dimensions	for junction boxes and flat control panels	for junction boxes and flat control panels
Mounting type	DIN rail mounting	DIN rail mounting
Weight	130 g	130 g
Type of connectors	Screw terminal	Screw terminal
Connector size	0.2 – 2.5 mm ² (AWG 24 – 14)	0.2 – 2.5 mm ² (AWG 24 – 14)
Efficiency	84 %	85 %
Approvals	CE UL 1310 Class 2	CE UL 1310 Class 2

wipos PB1 Modules

Power supply *wipos* PB1 12-2.75 PB1 24-1.5



Type	Part No.	Part No.
wipos PB1 12-2.75	81.000.6332.0	
wipos PB1 24-1.5		81.000.6320.0
Technical Data		
Input voltage	90 – 264 V AC, 120 – 375 V DC	90 – 264 V AC, 120 – 375 V DC
PFC	not necessary	not necessary
Hold up time	> 60 ms at 230 V	> 100 ms at 230 V
Output voltage	12 – 14 V	24 – 28 V
Output current	4.5 A	1.5 A
Temperature range	-40 ... +70 °C	-25 ... +70 °C
Derating	> 56 °C	> 56 °C
LED display	yes	yes
Dimensions W x H x D	71 x 91 x 57	53 x 91 x 57
Installation dimensions	for junction boxes and flat control panels	for junction boxes and flat control panels
Mounting type	DIN rail mounting	DIN rail mounting
Weight	250 g	190 g
Type of connectors	Screw terminal	Screw terminal
Connector size	0.2 – 2.5 mm ² (AWG 24–14)	0.2 – 2.5 mm ² (AWG 24–14)
Efficiency	84 %	84 %
Approvals	CE UL 1310 Class 2	CE UL 1310 Class 2

Power supply *wipos* PB1 12-4.5 PB1 24-2.5



Type	Part No.	Part No.
wipos PB1 12-4.5	81.000.6342.0	
wipos PB1 24-2.5		81.000.6330.0
Technical Data		
Input voltage	90 – 264 V AC, 120 – 375 V DC	90 – 264 V AC, 120 – 375 V DC
PFC	not necessary	not necessary
Hold up time	> 60 ms at 230 V	> 60 ms at 230 V
Output voltage	12 – 14 V	24 – 28 V
Output current	4.5 A	2.5 A
Temperature range	-40 ... +70 °C	-25 ... +70 °C
Derating	> 56 °C	> 60 °C
LED display	ja	yes
Dimensions W x H x D	71 x 91 x 57	71 x 91 x 57
Installation dimensions	for junction boxes and flat control panels	for junction boxes and flat control panels
Mounting type	DIN rail mounting	DIN rail mounting and screw connection
Weight	250 g	250 g
Type of connectors	Screw terminal	Screw terminal
Connector size	0.2 – 2.5 mm ² (AWG 24–14)	0.2 – 2.5 mm ² (AWG 24–14)
Efficiency	84 %	86 %
Approvals	CE UL 1310 Class 2 Haz. Class I Div.2	CE UL 1310 Class 2 Haz. Class I Div.2

Power supply *wipos* PB1 24-4.2



Type	Part No.
wipos PB1 24-4.2	81.000.6340.0
Technical Data	
Input voltage	90 – 264 V AC, 120 – 375 V DC
PFC	not necessary
Hold up time	> 60 ms at 230 V
Output voltage	24 – 28 V
Output current	4.2 A
Temperature range	-40 ... +70 °C
Derating	> 60 °C
LED display	yes
Dimensions W x H x D	90 x 91 x 57
Installation dimensions	for junction boxes and flat control panels
Mounting type	DIN rail mounting and screw connection
Weight	380 g
Type of connectors	Screw terminal
Connector size	0.2 – 2.5 mm ² (AWG 24–14)
Efficiency	89 %
Approvals	CE Haz. Class I Div.2



Industrial Ethernet switches

Safe and fast communication
for your process.

Ethernet connections have become part of many areas of life. This global standard is also making inroads into automation technology. Ethernet switches have become quite common for safe networking and coupling between machines, or inside the system. They manage the data flow in an effective and target-oriented manner. The devices are designed to be very robust and are optimally suited to harsh industrial environments.





Benefits:

- Redundant power supply
- Full compatibility according to IEEE 802.3, including autocrossing, autonegotiation, autosensing, auto-polarity
- Complete diagnostics display via various LEDs
- Compact design
- DIN rail mounting or screw connection
- Robust designs
- High degree of protection (IP40)



Ethernet Switches (Fast Ethernet)

<p>wienet UMS 6-L</p> 	Type	Part No.
	wienet UMS 6-L	83.040.0000.1
	Technical Data	
	Number of ports	6 RJ45 ports
	Port types	6 x Ethernet and Fast Ethernet (10/100 Mbit/s)
	Store and forward switching mode	yes
	Autocrossing	yes
	Autonegotiation	yes
	Autosensing	yes
	Autopolarity	yes
	Full IEEE 802.3 compatibility	yes
	Line, star and network topologies are possible	yes
	Operating voltage	9 ... 30 V DC
	Redundant power supply	2 infeeds
	Diagnostic LEDs (power / link status / data / data rate)	yes / yes / yes / yes
	Operating temperature	0 ... +60 °C
	Dimensions (mm) W x H x D	45 x 90 x 80
	Housing	Thermoset
	Mounting	DIN rail and screw mounting
	Type of connectors	Screw terminal, pluggable
Connector size	up to 1.5 mm ² (AWG 16)	
Weight	160 g	
Degree of protection	IP 40	
Approvals	CE cULus FCC	

<p>wienet UMS 6</p> 	Type	Part No.
	wienet UMS 6	83.040.0000.0
	Technical Data	
	Number of ports	6 RJ45 ports
	Port types	6 x Ethernet and Fast Ethernet (10/100 Mbit/s)
	Store and forward switching mode	yes
	Autocrossing	yes
	Autonegotiation	yes
	Autosensing	yes
	Autopolarity	yes
	Full IEEE 802.3 compatibility	yes
	Line, star and network topologies are possible	yes
	Operating voltage	9 ... 30 V DC
	Redundant power supply	2 infeeds
	Diagnostic LEDs (power / link status / data / data rate)	yes / yes / yes / yes
	Operating temperature	0 ... +60 °C
	Dimensions (mm) W x H x D	45.3 x 90 x 90.5
	Housing	Aluminum extrusion
	Mounting	DIN rail and screw mounting
	Type of connectors	Screw terminal, pluggable
Connector size	up to 1.5 mm ² (AWG 16)	
Weight	250 g	
Degree of protection	IP 40	
Approvals	CE cULus FCC	

Ethernet Switches (Fast Ethernet)

wienet UMS 8



Type	Part No.
wienet UMS 8	83.040.0001.0
Technical Data	
Number of ports	8 RJ45-Ports
Port types	8 x Ethernet and Fast-Ethernet (10/100 Mbit/s)
Store and forward switching mode	yes
Autocrossing	yes
Autonegotiation	yes
Autosensing	yes
Autopolarity	yes
Full IEEE 802.3 compatibility	yes
Line, star and network topologies are possible	yes
Operating voltage	9 ... 30 V DC
Redundant power supply	2 infeeds
Diagnostic LEDs (power / link status / data / data rate)	yes / yes / yes / yes
Operating temperature	-10 ... +70 °C
Dimensions (mm) W x H x D	45.3 x 90 x 90.5
Housing	Aluminum extrusion
Mounting	DIN rail and screw mounting
Type of connectors	Screw terminal, pluggable
Connector size	up to 1.5 mm ² (AWG 16)
Weight	270 g
Degree of protection	IP 40
Approvals	CE  FCC



Ethernet Switches (Giga Ethernet)

wienet UMS 8-G



Type	Part No.
wienet UMS 8-G	83.040.0106.0
Technical Data	
Number of ports	8 x RJ45
Port types	6 x Giga-Ethernet (10/100/1000 Mbit/s)
Store and forward switching mode	yes
Autocrossing	yes
Autonegotiation	yes
Autosensing	yes
Autopolarity	yes
Full IEEE 802.3 compatibility	yes
Line, star and network topologies are possible	yes
Operating voltage	9 ... 48 V DC
Redundant power supply	2 infeeds
Diagnostic LEDs (power / link status / data / data rate)	yes / yes / yes / yes
Operating temperature	-10 ... +70 °C
Dimensions (mm) W x H x D	45.3 x 90 x 90.5
Housing	Metal
Mounting	DIN rail and screw mounting
Type of connectors	Screw terminal, pluggable
Connector size	0.2 – 1.5 mm ² (AWG 24–16)
Weight	255 g
Degree of protection	IP 50
Approvals	CE cULus FCC

wienet UMS 8-2G



Type	Part No.
wienet UMS 8-2G	83.040.0103.0
Technical Data	
Number of ports	10 RJ45-Ports
Port types	8 x Ethernet and Fast-Ethernet (10/100 Mbit/s) 2 x Giga-Ethernet (10/100/1000 Mbit/s)
Store and forward switching mode	yes
Autocrossing	yes
Autonegotiation	yes
Autosensing	yes
Autopolarity	yes
Full IEEE 802.3 compatibility	yes
Line, star and network topologies are possible	yes
Operating voltage	12 ... 48 V DC
Redundant power supply	2 infeeds
Diagnostic LEDs (power / link status / data / data rate)	yes / yes / yes / yes
Operating temperature	-40 ... +70 °C
Dimensions (mm) W x H x D	54 x 146 x 130.5
Housing	Aluminum extrusion
Mounting	DIN rail and screw mounting
Type of connectors	Screw terminal, pluggable
Connector size	up to 1.5 mm ² (AWG 16)
Weight	1000 g
Degree of protection	IP 40
Approvals	CE cULus FCC

Ethernet Switches (with optical ports)

wienet UMS 4-1FM



Type	Part No.
wienet UMS 4-1FM	83.040.0002.0
Technical Data	
Number of ports	4 x RJ45, 1 x ST (optical multi mode)
Port types	10/100BaseT(X), 100BaseFX
Store and forward switching mode	yes
Autocrossing	yes
Autonegotiation	yes
Autosensing	yes
Autopolarity	yes
Full IEEE 802.3 compatibility	yes
Line, star and network topologies are possible	yes
Operating voltage	9 ... 30 V DC
Redundant power supply	2 infeeds
Diagnostic LEDs (power / link status / data / data rate)	yes / yes / yes / yes
Operating temperature	-10 ... +70 °C
Dimensions W x H x D	45.3 x 90 x 90.5
Housing	Metal
Mounting	DIN rail and screw mounting
Type of connectors	Screw terminal, pluggable
Connector size	0.2 – 1.5 mm ² (AWG 24–16)
Weight	260 g
Degree of protection	IP 50
Approvals	CE i@us FCC

wienet UMS 4-1FS



Type	Part No.
wienet UMS 4-1FS	83.040.0003.0
Technical Data	
Number of ports	4 x RJ45, 1 x SC (optical single mode)
Port types	10/100BaseT(X), 100BaseFX
Store and forward switching mode	yes
Autocrossing	yes
Autonegotiation	yes
Autosensing	yes
Autopolarity	yes
Full IEEE 802.3 compatibility	yes
Line, star and network topologies are possible	yes
Operating voltage	9 ... 30 V DC
Redundant power supply	2 infeeds
Diagnostic LEDs (power / link status / data / data rate)	yes / yes / yes / yes
Operating temperature	-10 ... +70 °C
Dimensions W x H x D	45.3 x 90 x 90.5
Housing	Metal
Mounting	DIN rail and screw mounting
Type of connectors	Screw terminal, pluggable
Connector size	0.2 – 1.5 mm ² (AWG 24–16)
Weight	260 g
Degree of protection	IP 50
Approvals	CE i@us FCC

IDE





Applications

- Energy systems
 - Wind turbines
 - Solar farms
 - Biogas cogeneration systems
 - Heat pumps, ...
- Water and waste water Management
- System monitoring in machine building
 - Washing machines
 - Packaging machines
 - Compressors, ...
- External surveillance camera
- Vending
 - Telemetry online sales or ticket machines
- Smart metering
- Mobile Fleet Management



wienet VPN Industrial Router – unlimited M2M communication

Functionality which convinces

Whether it is about the control of machines, monitoring of production lines or the coordination of all production areas a permanent communication between devices is needed to complete such a complex task. Access to stored data using wireless networks is not always possible or safe. Now Wieland offers with its modern router technology the possibility of completing such complex tasks. For example control commands, level indicators or video signals can now be transmitted. At download speeds of up to 100 Mbit/s and upload speeds of up to 50 Mbit/s (depending on the network operator) the **wienet** VPN industrial router is sure to cover the available connectivity options of GPRS up to LTE. With automatic login **wienet** VPN industrial router will always access the fastest available connection.

Each router has its own IP address and can be configured through the integrated web interface.

It supports services such as DHCP, NAT and DynDNS. The routers communicate directly or via the control panel to open a secure VPN connection. The establishment of an IPSec encrypted tunnel is alternatively possible.

wienet VPN routers are ideal components for industrial use in conjunction with VPN-service portals, such as Wie-Service24.

With the arrangement of the ports on the front-panel and a standard USB port, the **wienet** VPN industrial router are extremely user friendly. A clear statistic of mobile connections is used for better control. Optionally, the devices are available with a second SIM card slot, additional I/O, RS-232, RS-422/RS-485, M-Bus, second Ethernet interface, Wi-Fi module or integrated 3 port switch.

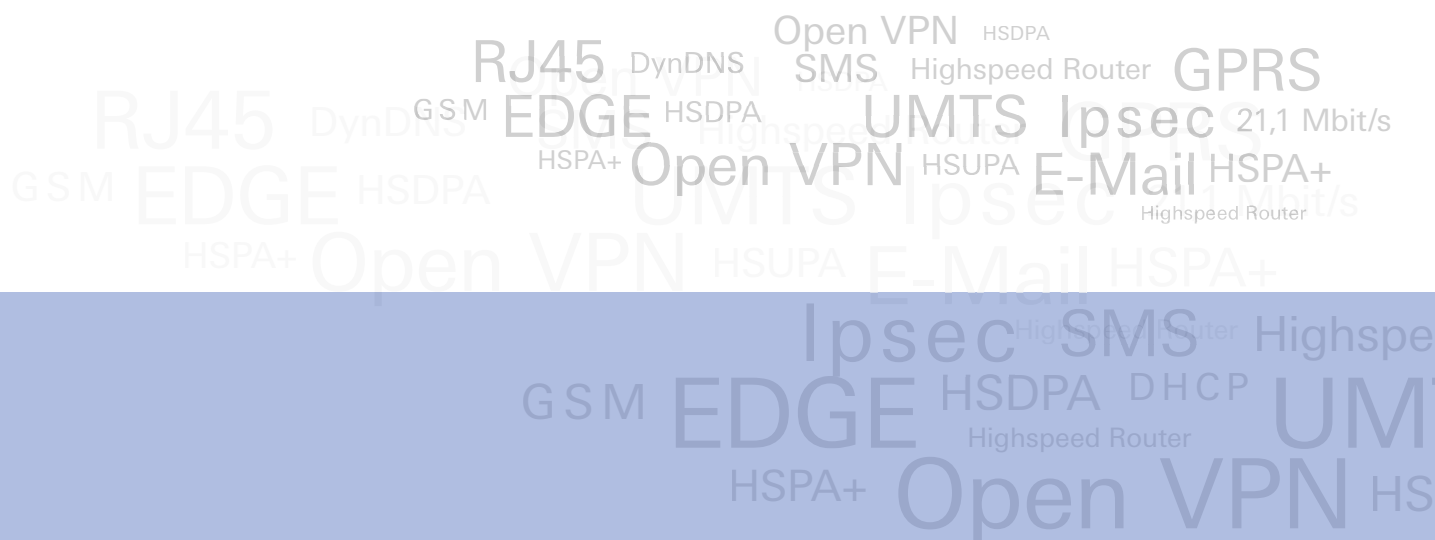

Industrial Mobile Router – GSM/GPRS/EDGE

EDGE mobile router „Basic“ wienet EDGE ER75i v2

- 1x SIM-card-slot
- 1x RJ45-Port extension
- Inclusive antenna
- Inclusive RJ45-Patch cable
- Inclusive DIN Rail clip
- Plastic or metal housing



Type	Port 1	Port 2	Part No.	Part No.
EDGE mobile router basic version			Aluminium	Plastic
wienet EDGE ER75iv2	-	-	83.041.0000.1	83.041.0000.0
wienet EDGE ER75iv2 RS232	RS-232	-	83.041.0001.1	-
wienet EDGE ER75iv2 RS485/422	RS-485/422	-	83.041.0002.1	-
wienet EDGE ER75iv2 MBUS	M-Bus	-	83.041.0003.1	-
wienet EDGE ER75iv2 CNT	4DI, 2DO, 2AI	-	83.041.0004.1	83.041.0004.0
wienet EDGE ER75iv2 ETH	Ethernet	-	83.041.0005.1	83.041.0005.0

Technical Data		
Housing	Aluminium	Plastic
Dimensions (mm) W x H x D	42 x 113 x 81	42 x 113 x 76
Weight	280 g	220 g
Transmission	GSM/GPRS/EDGE (Class 10)	
Frequency bands	850/900/1800/1900 MHz	
SIM-card-slots	1	
RJ45-extension-ports	1	
Interfaces	Ethernet 10/100 Mbit/s; USB 2.0 Type A (Host); 1x Digital In / 1x Digital Out	
Max. Download/Upload	236 Kbit/s / 118,4 Kbit/s	
VPN-Client for encrypted connection to the control center	IPSec Client/Server; OpenVPN Client/Server; L2TP; PPTP	
Mounting	DIN-rail or table	
Operating voltage	10 - 30 V DC	
Operating temperature	-30 ... +60°C	
Antenna	External GSM-antenna (SMA - 50 Ohm)	
Approvals	CE	
Norms	EN 301 511, v 9.0.2; EN 301 908-1&2, v 3.2.1; ETSI EN 301 489-1 V1.8.1; EN 60950-1:06 ed. 2 + A11:09	

Functions		
Support of NAT/PAT and X.509		
Firewall (SPI)		
VPN: OpenVPN, IPSec, L2TP, GRE		
Easy web interface, DHCP, DynDNS, VRRP; Dial-in		
Router-control by SMS		
Comprehensive mobile statistic options		
Data volume-/roaming-control by SMS		
Status information by SNMP and SMS		
Status by LED		
FTP		
Linux based Operating System: ability to integrate their own applications		

EDGE mobil router „Full“ wienet EDGE ER75i v2f SL

- 2x SIM-card-slot
- 2x RJ45-Port extension
- Inclusive antenna
- Inclusive RJ45-Patch cable
- Inclusive DIN Rail clip
- Plastic or metal housing



Type	Port 1	Port 2	Part No.	Part No.
EDGE mobil router full version			Aluminium	Plastic
wienet EDGE ER75iv2f SL	-	-	83.041.0100.1	-
wienet EDGE ER75iv2f SL RS232	RS-232	-	83.041.0101.1	-
wienet EDGE ER75iv2f SL RS485/422	RS-485/422	-	83.041.0102.1	-
wienet EDGE ER75iv2f SL MBUS	M-Bus	-	83.041.0103.1	-
wienet EDGE ER75iv2f SL IO	IO	-	83.041.0104.1	-
wienet EDGE ER75iv2f SL ETH	ETH	-	83.041.0105.1	-
wienet EDGE ER75iv2f SL WIFI	-	WI-FI/WLAN	83.041.0106.1	-
wienet EDGE ER75iv2f SL RS232 RS232	RS-232	RS-232	83.041.0111.1	-
wienet EDGE ER75iv2f SL RS485 RS232	RS-485/422	RS-232	83.041.0112.1	-
wienet EDGE ER75iv2f SL MBUS RS232	M-Bus	RS-232	83.041.0113.1	-
wienet EDGE ER75iv2f SL CNT RS232	IO	RS-232	83.041.0114.1	-
wienet EDGE ER75iv2f SL ETH RS232	ETH	RS-232	83.041.0115.1	-
wienet EDGE ER75iv2f SL RS485 RS485	RS-485/422	RS-485/422	83.041.0122.1	-
wienet EDGE ER75iv2f SL MBUS RS485	M-Bus	RS-485/422	83.041.0123.1	-
wienet EDGE ER75iv2f SL CNT RS485	IO	RS-485/422	83.041.0124.1	-
wienet EDGE ER75iv2f SL ETH RS485	ETH	RS-485/422	83.041.0125.1	-
wienet EDGE ER75iv2f SL RS232 WIFI	RS-232	WI-FI/WLAN	83.041.0161.1	-
wienet EDGE ER75iv2f SL RS485 WIFI	RS-485/422	WI-FI/WLAN	83.041.0162.1	-
wienet EDGE ER75iv2f SL MBUS WIFI	M-Bus	WI-FI/WLAN	83.041.0163.1	-
wienet EDGE ER75iv2f SL CNT WIFI	IO	WI-FI/WLAN	83.041.0164.1	-
wienet EDGE ER75iv2f SL ETH WIFI	ETH	WI-FI/WLAN	83.041.0165.1	-
wienet EDGE ER75iv2f SL 3P	3-port Switch	3-port Switch	83.041.0199.1	-

Technical Data		
SIM-card-slots	2	
RJ45-extension-ports	2	
Further technical data see basic version		

Functions		
see basic version		

Industrial Mobile Router – UMTS

UMTS mobil router „Basic“ wienet UMTS UR5 v2

- 1x SIM-card-slot
- 1x RJ45-Port extension
- Inclusive antenna
- Inclusive RJ45-Patch cable
- Inclusive DIN Rail clip
- Plastic or metal housing



Type	Port 1	Port 2	Part No.	Part No.
UMTS mobile router basic version			Aluminium	Plastic
wienet UMTS UR5v2	-	-	83.041.0020.1	83.041.0020.0
wienet UMTS UR5v2 RS232	RS-232	-	83.041.0021.1	-
wienet UMTS UR5v2 RS485/422	RS-485/422	-	83.041.0022.1	-
wienet UMTS UR5v2 MBUS	M-Bus	-	83.041.0023.1	-
wienet UMTS UR5v2 CNT	4DI, 2DO, 2AI	-	83.041.0024.1	-
wienet UMTS UR5v2 ETH	Ethernet	-	83.041.0025.1	83.041.0025.0

Technical Data

Housing	Aluminium	Plastic
Dimensions (mm) W x H x D	42 x 113 x 81	42 x 113 x 76
Weight	280 g	220 g
Transmission	GSM/GPRS/EDGE/UMTS/HSDPA	
Frequency bands - Dual-Band	UMTS: 900/2100 MHz; GSM: 900/1800 MHz	
SIM-card-slots	1	
RJ45-extension-ports	1	
Interfaces	Ethernet 10/100 Mbit/s; USB 2.0 Type A (Host); 1x Digital In / 1x Digital Out	
Max. Download/Upload	3,6 Mbit/s / 384Kbit/s	
VPN-Client for encrypted connection to the control center	IPSec Client/Server; OpenVPN Client/Server; L2TP; PPTP	
Mounting	DIN-rail or table	
Operating voltage	10 - 30 V DC	
Operating temperature	-30 ... +60°C	
Antenna	External GSM-antenna (SMA - 50 Ohm)	
Approvals	CE	
Norms	EN 301 511, v 9.0.2; EN 301 908-1&2, v 3.2.1; ETSI EN 301 489-1 V1.8.1; EN 60950-1:06 ed. 2 + A11:09	

Functions

Support of NAT/PAT and X.509
 Firewall (SPI)
 VPN: OpenVPN, IPsec, L2TP, GRE
 Easy web interface, DHCP, DynDNS, VRRP; Dial-in
 Router-control by SMS
 Comprehensive mobile statistic options
 Data volume-/roaming-control by SMS
 Status information by SNMP and SMS
 Status by LED
 FTP
 Linux based Operating System: ability to integrate their own applications

UMTS mobile router „Full“ wienet UMTS UR5 v2f SL

- 2x SIM-card-slot
- 2x RJ45-Port extension
- Inclusive antenna
- Inclusive RJ45-Patch cable
- Inclusive DIN Rail clip
- Plastic or metal housing



Type	Port 1	Port 2	Part No.	Part No.
UMTS mobile router full version			Aluminium	Plastic
wienet UMTS UR5v2f SL	-	-	83.041.0200.1	-
wienet UMTS UR5v2f SL RS232	RS-232	-	83.041.0201.1	-
wienet UMTS UR5v2f SL RS485/422	RS-485/422	-	83.041.0202.1	-
wienet UMTS UR5v2f SL MBUS	M-Bus	-	83.041.0203.1	-
wienet UMTS UR5v2f SL IO	IO	-	83.041.0204.1	-
wienet UMTS UR5v2f SL ETH	ETH	-	83.041.0205.1	-
wienet UMTS UR5v2f SL WIFI	-	WI-FI/WLAN	83.041.0206.1	-
wienet UMTS UR5v2f SL RS232 RS232	RS-232	RS-232	83.041.0211.1	-
wienet UMTS UR5v2f SL RS485 RS232	RS-485/422	RS-232	83.041.0212.1	-
wienet UMTS UR5v2f SL MBUS RS232	M-Bus	RS-232	83.041.0213.1	-
wienet UMTS UR5v2f SL CNT RS232	IO	RS-232	83.041.0214.1	-
wienet UMTS UR5v2f SL ETH RS232	ETH	RS-232	83.041.0215.1	-
wienet UMTS UR5v2f SL RS485 RS485	RS-485/422	RS-485/422	83.041.0222.1	-
wienet UMTS UR5v2f SL MBUS RS485	M-Bus	RS-485/422	83.041.0223.1	-
wienet UMTS UR5v2f SL CNT RS485	IO	RS-485/422	83.041.0224.1	-
wienet UMTS UR5v2f SL ETH RS485	ETH	RS-485/422	83.041.0225.1	-
wienet UMTS UR5v2f SL RS232 WIFI	RS-232	WI-FI/WLAN	83.041.0261.1	-
wienet UMTS UR5v2f SL RS485 WIFI	RS-485/422	WI-FI/WLAN	83.041.0262.1	-
wienet UMTS UR5v2f SL MBUS WIFI	M-Bus	WI-FI/WLAN	83.041.0263.1	-
wienet UMTS UR5v2f SL CNT WIFI	IO	WI-FI/WLAN	83.041.0264.1	-
wienet UMTS UR5v2f SL ETH WIFI	ETH	WI-FI/WLAN	83.041.0265.1	-
wienet UMTS UR5v2f SL 3P	3-port Switch	3-port Switch	83.041.0299.1	-

Technical Data

SIM-card-slots	2
RJ45-extension-ports	2
Further technical data see basic version	

Functions

see basic version

Industrial Mobile Router – HSPA+

HSPA+ mobile router „Basic“ wienet HSPA+ UR5i v2

- 1x SIM-card-slot
- 1x RJ45-Port extension
- Inclusive antenna
- Inclusive RJ45-Patch cable
- Inclusive DIN Rail clip
- Plastic or metal housing



Type	Port 1	Port 2	Part No.	Part No.
HSPA+ mobile router basic version			Aluminium	Plastic
wienet HSPA+ UR5iv2	-	-	83.041.0040.1	83.041.0040.0
wienet HSPA+ UR5iv2 RS232	RS-232	-	83.041.0041.1	-
wienet HSPA+ UR5iv2 RS485/422	RS-485/422	-	83.041.0042.1	-
wienet HSPA+ UR5iv2 MBUS	M-Bus	-	83.041.0043.1	-
wienet HSPA+ UR5iv2 CNT	4DI, 2DO, 2AI	-	83.041.0044.1	-
wienet HSPA+ UR5iv2 ETH	Ethernet	-	83.041.0045.1	83.041.0045.0

Technical Data		
Housing	Aluminium	Plastic
Dimensions (mm) W x H x D	42 x 113 x 81	42 x 113 x 76
Weight	280 g	220 g
Transmission	GSM/GPRS/EDGE/UMTS/HSDPA/HSPA+	
Frequency bands	Quad-Band UMTS (WCDMA): 850/900/1900/2100 MHz Quad-Band GSM/GPRS/EDGE: 850/900/1800/1900 MHz	
SIM-card-slots	1	
RJ45-extension-ports	1	
Interfaces	Ethernet 10/100 Mbit/s; USB 2.0 Type A (Host); 1x Digital In / 1x Digital Out	
Max. Download/Upload	21,1 Mbit/s / 5,7Mbit/s	
VPN-Client for encrypted connection to the control center	IPSec Client/Server; OpenVPN Client/Server; L2TP; PPTP	
Mounting	DIN-rail or table	
Operating voltage	10 - 30 V DC	
Operating temperature	-30 ... +60°C	
Antenna	External GSM-antenna (SMA - 50 Ohm)	
Approvals	CE	
Norms	EN 301 511, v 9.0.2; EN 301 908-1&2, v 3.2.1; ETSI EN 301 489-1 V1.8.1; EN 60950-1:06 ed. 2 + A11:09	

Functions		
Support of NAT/PAT and X.509		
Firewall (SPI)		
VPN: OpenVPN, IPsec, L2TP, GRE		
Easy web interface, DHCP, DynDNS, VRRP; Dial-in		
Router-control by SMS		
Comprehensive mobile statistic options		
Data volume-/roaming-control by SMS		
Status information by SNMP and SMS		
Status by LED		
FTP		
Linux based Operating System: ability to integrate their own applications		

HSPA+ mobilfunkrouter „Full“ wienet HSPA+ UR5i v2f SL

- 2x SIM-card-slot
- 2x RJ45-Port extension
- Inclusive antenna
- Inclusive RJ45-Patch cable
- Inclusive DIN Rail clip
- Plastic or metal housing



Type	Port 1	Port 2	Part No.	Part No.
HSPA+ mobile router full version			Aluminium	Plastic
wienet HSPA+ UR5iv2f SL	-	-	83.041.0400.1	-
wienet HSPA+ UR5iv2f SL RS232	RS-232	-	83.041.0401.1	-
wienet HSPA+ UR5iv2f SL RS485/422	RS-485/422	-	83.041.0402.1	-
wienet HSPA+ UR5iv2f SL MBUS	M-Bus	-	83.041.0403.1	-
wienet HSPA+ UR5iv2f SL IO	IO	-	83.041.0404.1	-
wienet HSPA+ UR5iv2f SL ETH	ETH	-	83.041.0405.1	-
wienet HSPA+ UR5iv2f SL WIFI	-	WI-FI/WLAN	83.041.0406.1	-
wienet HSPA+ UR5iv2f SL RS232 RS232	RS-232	RS-232	83.041.0411.1	-
wienet HSPA+ UR5iv2f SL RS485 RS232	RS-485/422	RS-232	83.041.0412.1	-
wienet HSPA+ UR5iv2f SL MBUS RS232	M-Bus	RS-232	83.041.0413.1	-
wienet HSPA+ UR5iv2f SL CNT RS232	IO	RS-232	83.041.0414.1	-
wienet HSPA+ UR5iv2f SL ETH RS232	ETH	RS-232	83.041.0415.1	-
wienet HSPA+ UR5iv2f SL RS485 RS485	RS-485/422	RS-485/422	83.041.0422.1	-
wienet HSPA+ UR5iv2f SL MBUS RS485	M-Bus	RS-485/422	83.041.0423.1	-
wienet HSPA+ UR5iv2f SL CNT RS485	IO	RS-485/422	83.041.0424.1	-
wienet HSPA+ UR5iv2f SL ETH RS485	ETH	RS-485/422	83.041.0425.1	-
wienet HSPA+ UR5iv2f SL RS232 WIFI	RS-232	WI-FI/WLAN	83.041.0461.1	-
wienet HSPA+ UR5iv2f SL RS485 WIFI	RS-485/422	WI-FI/WLAN	83.041.0462.1	-
wienet HSPA+ UR5iv2f SL MBUS WIFI	M-Bus	WI-FI/WLAN	83.041.0463.1	-
wienet HSPA+ UR5iv2f SL CNT WIFI	IO	WI-FI/WLAN	83.041.0464.1	-
wienet HSPA+ UR5iv2f SL ETH WIFI	ETH	WI-FI/WLAN	83.041.0465.1	-
wienet HSPA+ UR5iv2f SL 3P	3-port Switch	3-port Switch	83.041.0499.1	-

Technical Data		
SIM-card-slots	2	
RJ45-extension-ports	2	
Further technical data see basic version		

Functions		
see basic version		

Industrial Mobile Router – LTE 4G

LTE mobile router 4G „Basic“ **wienet** LTE LR77 v2 SL

- 1x SIM-card-slot
- 1x RJ45-Port extension
- Inclusive antenna
- Inclusive RJ45-Patch cable
- Inclusive DIN Rail clip
- Plastic or metal housing



Type	Port 1	Port 2	Part No.	Part No.
LTE-Mobilfunkrouter 4G basic version			Aluminium	Plastic
wienet LTE LR77v2	-	-	83.041.0050.1	83.041.0050.0
wienet LTE LR77v2 RS232	RS-232	-	83.041.0051.1	-
wienet LTE LR77v2 RS485/422	RS-485/422	-	83.041.0052.1	-
wienet LTE LR77v2 MBUS	M-Bus	-	83.041.0053.1	-
wienet LTE LR77v2 CNT	4DI, 2DO, 2AI	-	83.041.0054.1	-
wienet LTE LR77v2 ETH	Ethernet	-	83.041.0055.1	83.041.0055.0

Technical Data		
Housing	Aluminium	Plastic
Dimensions (mm) W x H x D	42 x 113 x 81	42 x 113 x 76
Weight	280 g	220 g
Transmission	GSM/GPRS/EDGE/UMTS/HSDPA/HSPA+/LTE	
Frequency bands	LTE: 800/900/1800/2100/2600 MHz; UMTS: 900/2100 MHz; GSM/GPRS/EDGE: 900/1800/1900 MHz	
SIM-card-slots	1	
RJ45-extension-ports	1	
Interfaces	Ethernet 10/100 Mbit/s; USB 2.0 Type A (Host); 1x Digital In / 1x Digital Out	
Max. Download/Upload	100 Mbit/s / 50 Mbit/s	
VPN-Client for encrypted connection to the control center	IPSec Client/Server; OpenVPN Client/Server; L2TP; PPTP	
Mounting	DIN-rail or table	
Operating voltage	10 - 30 V DC	
Operating temperature	-30 ... +60°C	
Antenna	External GSM-antenna (SMA - 50 Ohm)	
Approvals	CE	
Norms	EN 301 511, v 9.0.2; EN 301 908-1&2, v 3.2.1; ETSI EN 301 489-1 V1.8.1; EN 60950-1:06 ed. 2 + A11:09	

Functions		
Support of NAT/PAT and X.509		
Firewall (SPI)		
VPN: OpenVPN, IPsec, L2TP, GRE		
Easy web interface, DHCP, DynDNS, VRRP; Dial-in		
Router-control by SMS		
Comprehensive mobile statistic options		
Data volume-/roaming-control by SMS		
Status information by SNMP and SMS		
Status by LED		
FTP		
Linux based Operating System: ability to integrate their own applications		

LTE mobile router 4G „Full“ **wienet** LTE LR77 v2f SL

- 2x SIM-card-slot
- 2x RJ45-Port extension
- Inclusive antenna
- Inclusive RJ45-Patch cable
- Inclusive DIN Rail clip
- Plastic or metal housing



Type	Port 1	Port 2	Part No.	Part No.
LTE mobile router 4G full version			Aluminium	Plastic
wienet LTE LR77v2f SL	-	-	83.041.0500.1	-
wienet LTE LR77v2f SL RS232	RS-232	-	83.041.0501.1	-
wienet LTE LR77v2f SL RS485/422	RS-485/422	-	83.041.0502.1	-
wienet LTE LR77v2f SL MBUS	M-Bus	-	83.041.0503.1	-
wienet LTE LR77v2f SL IO	IO	-	83.041.0504.1	-
wienet LTE LR77v2f SL ETH	ETH	-	83.041.0505.1	-
wienet LTE LR77v2f SL WIFI	-	WI-FI/WLAN	83.041.0506.1	-
wienet LTE LR77v2f SL RS232 RS232	RS-232	RS-232	83.041.0511.1	-
wienet LTE LR77v2f SL RS485 RS232	RS-485/422	RS-232	83.041.0512.1	-
wienet LTE LR77v2f SL MBUS RS232	M-Bus	RS-232	83.041.0513.1	-
wienet LTE LR77v2f SL CNT RS232	IO	RS-232	83.041.0514.1	-
wienet LTE LR77v2f SL ETH RS232	ETH	RS-232	83.041.0515.1	-
wienet LTE LR77v2f SL RS485 RS485	RS-485/422	RS-485/422	83.041.0522.1	-
wienet LTE LR77v2f SL MBUS RS485	M-Bus	RS-485/422	83.041.0523.1	-
wienet LTE LR77v2f SL CNT RS485	IO	RS-485/422	83.041.0524.1	-
wienet LTE LR77v2f SL ETH RS485	ETH	RS-485/422	83.041.0525.1	-
wienet LTE LR77v2f SL RS232 WIFI	RS-232	WI-FI/WLAN	83.041.0561.1	-
wienet LTE LR77v2f SL RS485 WIFI	RS-485/422	WI-FI/WLAN	83.041.0562.1	-
wienet LTE LR77v2f SL MBUS WIFI	M-Bus	WI-FI/WLAN	83.041.0563.1	-
wienet LTE LR77v2f SL CNT WIFI	IO	WI-FI/WLAN	83.041.0564.1	-
wienet LTE LR77v2f SL ETH WIFI	ETH	WI-FI/WLAN	83.041.0565.1	-
wienet LTE LR77v2f SL 3P	3-port Switch	3-port Switch	83.041.0599.1	-

Technical Data	
SIM-card-slots	2
RJ45-extension-ports	2
Further technical data see basic version	

Functions	
see basic version	

Industrial Router – LAN-to-LAN

LAN-to-LAN router **wienet LAN XR5i v2**

- inklusive 2xRJ45-Patch cable
- Inclusive DIN Rail clip
- Plastic or metal housing



Type	Port 1	Port 2	Part No.	Part No.
LAN-to-LAN router			Aluminium	Plastic
wienet LAN XR5iv2 ETH	Ethernet	-	83.041.0065.1	83.041.0065.0
wienet LAN XR5iv2f SL ETH RS232	Ethernet	RS-232	83.041.0071.1	-
wienet LAN XR5iv2f SL ETH RS485	Ethernet	RS-485	83.041.0072.1	-
wienet LAN XR5iv2f SL RS232 WIFI	RS-232	WI-FI/WLAN	83.041.0081.1	-
wienet LAN XR5iv2f SL RS485 WIFI	RS-485	WI-FI/WLAN	83.041.0082.1	-
wienet LAN XR5iv2f SL MBUS WIFI	M-Bus	WI-FI/WLAN	83.041.0083.1	-
wienet LAN XR5iv2f SL IO WIFI	4DI, 2DO, 2AI	WI-FI/WLAN	83.041.0084.1	-
wienet LAN XR5iv2f SL ETH WIFI	Ethernet	WI-FI/WLAN	83.041.0085.1	-

Technical Data		
Housing	Aluminium	Plastic
Dimensions (mm) W x H x D	42 x 113 x 81	42 x 113 x 76
Weight	280 g	220 g
Transmission	LAN-to-LAN, WI-FI/WLAN	
RJ45-extension-ports	1 (basic version), 2 (full version)	
Interfaces	Ethernet 10/100 Mbit/s; USB 2.0 Typ A (Host); 1x Digital In / 1x Digital Out	
Max. Download/Upload	Fast Ethernet	
VPN-Client for encrypted connection to the control center	IPSec Client/Server; L2TP; PPTP	
Mounting	DIN-rail or table	
Operating voltage	10 - 30 V DC	
Operating temperature	-30 ... +60°C	
Approvals	CE	
Norms	ETSI EN 301 489-1 V1.8.1; EN 60950-1:06 ed. 2 + A11:09	

Functions		
Support of NAT/PAT and X.509		
Firewall (SPI)		
VPN: OpenVPN, IPsec, L2TP, GRE		
Easy web interface, DHCP, DynDNS, VRRP; Dial-in		
PPPoE - DSL-Modem Support		
Status by LED		
SNMP - Integration to the network management		
FTP		
Linux based Operating System: ability to integrate their own applications		

Omnidirectional rod antenna **wienet GXS606**



Type	Part No.
wienet GXS606	83.041.0210.0

Technical Data	
Frequency bandwidth	GSM, GPRS, EDGE, UMTS
Connector	FME/F
Gain	2.2 dBi
Length of cable	5 m
Dimensions	Length of rod approx. 300 mm

Top flat antenna **wienet GXR623**



Type	Part No.
wienet GXR623	83.041.0200.0

Technical Data	
Frequency bandwidth	GSM, GPRS, EDGE, UMTS
Connector	FME/F
Gain	2.2 dBi
Length of cable	2.5 m
Dimensions	approx. 75 x 80 x 13 mm

VPN-Server „Wie-Service24“

Additional VPN channels to VPN-server Wie-Service24

- Rent of additional VPN-tunnels to VPN-Server of Wieland Electric
- High availability of VPN connections
- Immediately usable
- Client access on the server



Type		Part No.
wienet WIE-SERVICE24-EINZEL-R	VPN-Router-Client	ZD.000.0011.0
wienet WIE-SERVICE24-EINZEL-PC	VPN-PC-Client	ZD.000.0011.1
Properties		
Security by VPN		
Automatic generation of router configurations		
Only outgoing connections to the VPN server Wie-Service24		
No changes in the local network needed		
Connection complete networks without additional route settings		
Contract data		
Calculation	12 months in advance	
Termination	any time at the end of a month	
Administration	Wieland Electric	
Server hardware	Internet high-performance computing center	

Customer installation of the VPN server Wie-Service24

- Customer installation of the VPN server
- Administration on customer side
- High availability of VPN connections
- Customized layout possible



Type	Installation	Part No.
wienet WIESERVICE24-VM	Virtual machine "Oracle Virtual Box"	ZD.000.0012.0
wienet WIESERVICE24-IPC SAVE	On energy-saving PC hardware	ZD.000.0013.0
wienet WIESERVICE24-IPC HIGH	On High Performance 19 "PC	ZD.000.0014.0
wienet WIESERVICE24-DC CUSTOM	In customer data center	ZD.000.0015.0
wienet WIESERVICE24-DC INTERN.	In internet data center ("in the cloud")	ZD.000.0016.0
Properties		
Security by VPN		
Automatic generation of router configurations		
Only outgoing connections to the VPN server Wie-Service24		
No changes in the local network needed		
Connection complete networks without additional route settings		
Contract data		
Calculation	Fixed rate	
Number of VPN connections	> 1000	
Administration	customer	
Server hardware	selectable	

More security, more service, simply more Wie-Service24



A perfect team

The Wie-Service24 portal is optimized for the Wieland mobile and LAN-to-LAN router. It automatically generates the configuration of the router and provides it for download. By this automatic setup possible failures will be minimized. Wie-Service24 generates and categorizes certificates for Wieland router. It regulates within a bigger group who is able to communicate with who. The combination of Wie-Service24 and the Wieland router enable a fast commissioning and a highly secure VPN connection.

Advantages

- Security by VPN
- Automatic generation of router configuration
- Only outgoing connections towards Wie-Service24 are necessary
- No changes inside the local network is necessary
- Interconnection of complete networks, without additional routing configuration
- Little coordination with IT department and easy commissioning
- Mobile access by Smartphone or tablet to all devices behind the router
- directRemote: Direct access with all internet browser by a clearly URL

Wie-Service24 VPN Service Portal All machines online!

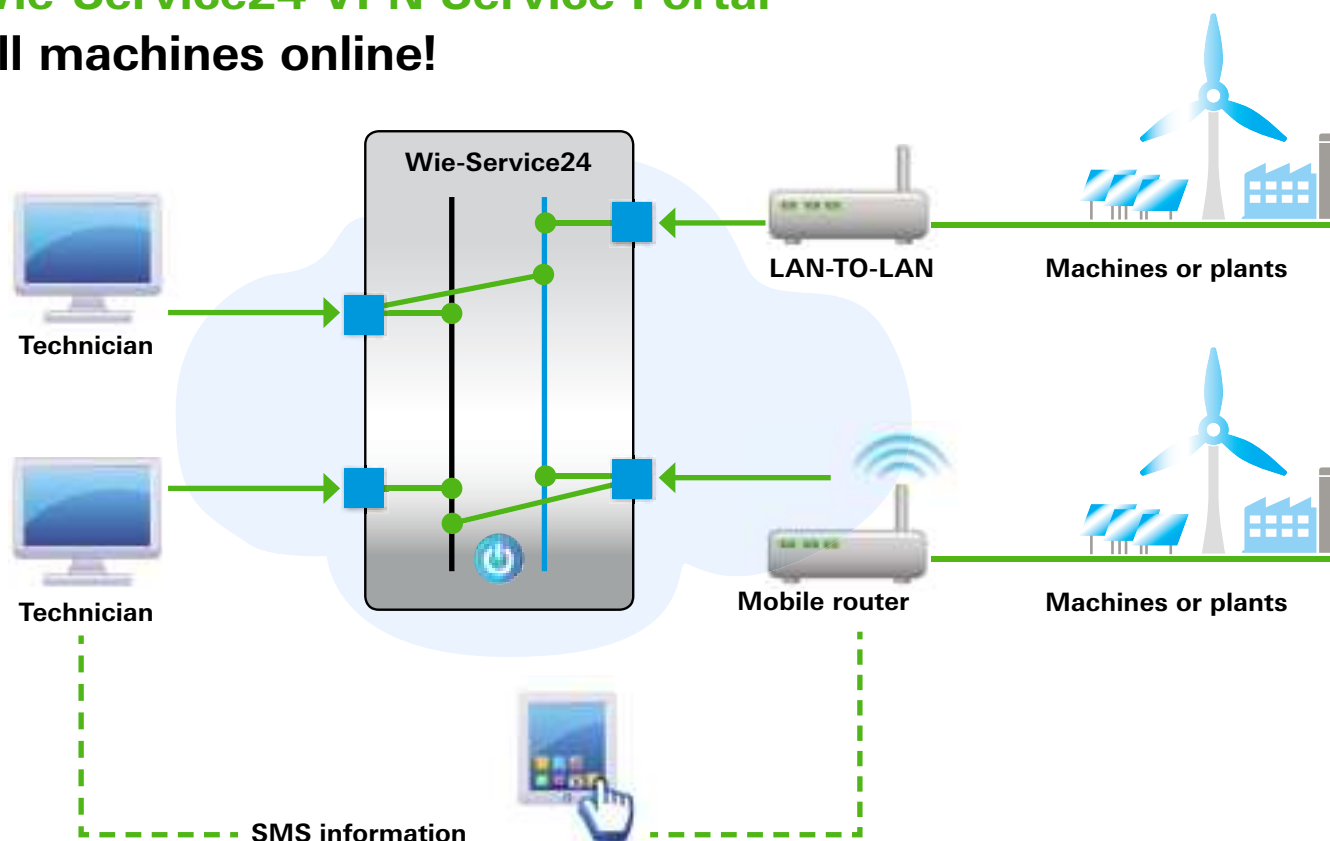

The Wie-Service24 VPN service portal is available in different configurations:

You can try the working with the VPN-server Wie-Service24 with up to 30 routers and one PC client for free. If you need further VPN clients you can rent more router and PC clients. We propose the installation of your own customer VPN server portal. Installation of the portal on a virtual machine, on an industrial PC, data center at customer site or a data center on an internet server.

	Single access	Virtual machine	Industrial PC	Data center Server at Customer	Data center Internet server
Part-No.	ZD.000.0011.0 (Router) ZD.000.0011.1 (PC-Client)	ZD.000.0012.0	ZD.000.0013.0 (Energy Saving) ZD.000.0014.0 (High Performance)	ZD.000.0015.0	ZD.000.0016.0
User access	•	•	•	•	•
Administrator access	–	•	•	•	•
Server hardware from	Wieland	Customer	Wieland	Customer	Provider
Internet connection by	Wieland	Customer	Customer	Customer	Provider
Installation by	Wieland	Customer or Wieland	Wieland	Wieland	Wieland



More information is available from our technical support:

Telefon +49 951 9324-995
 Telefax +49 951 9326-991
 wie-service24@wieland-electric.com



Coupling relays

The safe way to achieve a perfect interface in process applications.

In the microchip age of bits and bytes, one might assume that there is no place left for electro-mechanical relays. Far from it!

In control, transportation and production technology, coupling relays have been reliably accomplishing important tasks for years, and continue to do so.

Together with control systems, they offer numerous possibilities of making your application even safer and less sensitive to disturbances.







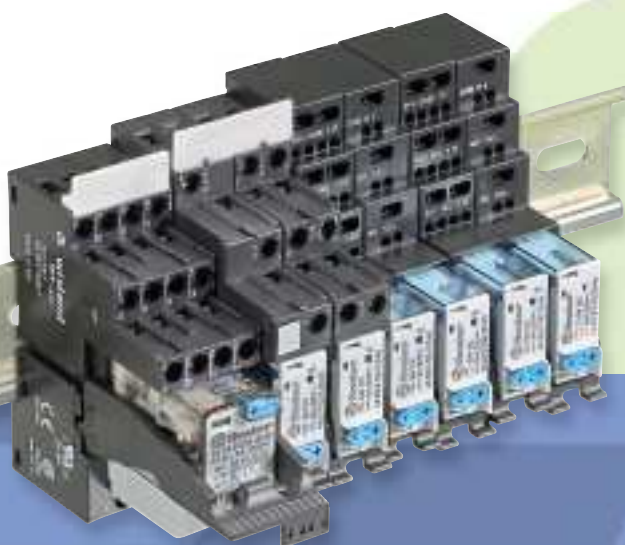

Advantages:

- Safe galvanic separation
- Pluggable and compact solutions
- Mounts directly onto a 35-mm DIN rail
- Optional gold-plated contacts
- Screw clamp and tension spring termination
- Display and EMI suppression modules
- Also suitable for railway applications acc. to EN 50155



Coupling relays

<p>flare MOVE</p> <ul style="list-style-type: none"> • Pluggable coupling relay • Overall width 6.2 mm • Screw terminals • 1 change-over contact 6A 	Description		Part No.	Std. Pack	Part No.	Std. Pack		
	flare MOVE		AgSnO₂		AgSnO₂ + gold (5μ)			
	12V Relay module DC		80.010.4501.0	10	80.010.4501.1	10		
	12V Relay module AC/DC		80.010.4521.0	10	80.010.4521.1	10		
	24V Relay module DC		80.010.4502.0	10	80.010.4502.1	10		
	24V Relay module AC/DC spring clamp con.		80.010.4622.0	10				
	24V Relay module AC/DC		80.010.4522.0	10	80.010.4522.1	10		
	115V Relay module AC/DC		80.010.4525.0	10	80.010.4525.1	10		
	230V Relay module AC/DC		80.010.4526.0	10	80.010.4526.1	10		
	Comb-shaped jumper 20pol. max 36A		80.063.4029.1	10				
	Marking plate BM SF38		80.063.4129.3	1				
	Replacement relay and socket		Information on request					
	Technical data							
	Maximum switching voltage		400 V AC					
	Maximum switching current		6 A AC/DC					
Maximum starting current		10 A						
Mechanical life		1 x 10 ⁷						
Electrical life up to 230 V AC / 6A		6 x 10 ⁴						
Isolation voltage of input / output		4 kV eff						
Connectable via pluggable jumper		20 modules						
Wire range fine-stranded/solid		0.14 - 1.5 mm ² (AWG 26–16) / 0.5 - 2.5 mm ² (AWG 22–14)						
Degree of protection / Mounting rail		IP 20 / TS35						
Dimensions (mm) W x H x D		6.2 x 88 x 76						
Ambient temperature		0 ... +50 °C						
Approvals		CE  						

<p>flare MOVE</p> <ul style="list-style-type: none"> • Pluggable coupling relay • Overall width 15.8 mm • Screw terminals • 1 change-over contact 16A • 2 change-over contacts 8A 	Description		Part No.	Std. Pack	Part No.	Std. Pack		
	flare MOVE		1 change-over contact		2 change-over contacts			
	12V Relay module DC		80.010.4901.3	10	80.010.5501.2	10		
	24V Relay module DC		80.010.4902.3	10	80.010.5102.2	10		
	24V Relay module AC		80.010.4912.3	10				
	115V Relay module AC		80.010.4915.3	10	80.010.5315.2	10		
	230V Relay module AC		80.010.4916.3	10	80.010.5316.2	10		
	Comb-shaped jumper 8pol. for A1, A2 max 10A		80.063.5029.2	10				
	Marking tag BZ SF-48		80.063.5029.3	10				
	Replacement relay		Information on request					
	Technical data							
	Maximum switching voltage		400 V AC		250 V AC			
	Maximum switching current		16 A / (10 A up to 12 V)		8 A			
	Maximum starting current		30 A / (20 A up to 12 V)		15 A			
	Mechanical life DC / AC		2 x 10 ⁷ / 1 x 10 ⁷		2 x 10 ⁷			
Electrical life AC 1		2 x 10 ⁵ / 1 x 10 ⁵		1 x 10 ⁵				
Isolation voltage of input / output		4 kV						
Connectable via pluggable jumper		8 modules						
Wire range fine-stranded/solid		0.25 - 4 mm ² (AWG 24–12) / 0.25 - 6 mm ² (AWG 24–10)						
Degree of protection / Mounting rail		IP 20 / TS35						
Dimensions (mm) W x H x D		15.8 x 78.6 x 76						
Ambient temperature		-40 ... +70 °C						
Approvals		CE  						



Coupling relays

flare MOVE MR

- Pluggable coupling relay
- Robust pins
- Switching position is indicated mechanically
- Lockable test button
- For railway application accord. to EN 50 155
- Overall width 15.8 mm
- Screw terminals
- 1 change-over contact 16A
- 2 change-over contacts 8A



Description	Part No.	Std. Pack	Part No.	Std. Pack
flare MOVE MR	1 change-over contact		2 change-over contacts	
24V Relay module DC	80.010.6002.2	10	80.010.6032.2	10
24V Relay module DC with gold (5µm)	80.010.6002.3	10	80.010.6032.3	
Replacement relay	Information on request			
Comb-shaped jumper 8 pole for A1, A2 max 10A	80.063.5029.2	10		
Marking plate BM MR-4C	80.063.6029.3	10		
Technical data				
Maximum switching voltage	440 V AC		440 V AC	
Maximum switching current	16 A		8 A	
Maximum starting current	25 A		15 A	
Mechanical life	1 x 10 ⁷		1 x 10 ⁷	
Electrical life AC 1	1 x 10 ⁵		1 x 10 ⁵	
Isolation voltage of input / output	6 kV			
Wire range fine-stranded/solid	0.25 - 4 mm ² (AWG 24-12) / 0.25 - 6 mm ² (AWG 24-10)			
Degree of protection / Mounting rail	IP 20 / TS35			
Dimensions (mm) W x H x D	15.8 x 82.9 x 68.1			
Ambient temperature	-40...+70 °C (>12A max 50 °C) -40...+70 °C			
Approvals	CE TÜV US			

flare MOVE MR

- Pluggable coupling relay
- Robust pins
- Switching position is indicated mechanically
- Lockable test button
- For railway application accord. to EN 50 155
- Overall width 15.8mm
- Cage clamp
- 1 change-over contact 16A
- 2 change-over contacts 8A



Description	Part No.	Std. Pack	Part No.	Std. Pack
flare MOVE MR	1 change-over contact		2 change-over contacts	
24V Relay module DC	80.010.6102.2	10	80.010.6132.2	10
24V Relay module DC with gold (5µm)	80.010.6102.3	10	80.010.6132.3	
Replacement relay	Information on request			
Marking plate BM MR-4C	80.063.6029.3	10		
Technical data				
Maximum switching voltage	400 V AC		400 V AC	
Maximum switching current	16 A		8 A	
Maximum starting current	25 A		15 A	
Mechanical life	1 x 10 ⁷		1 x 10 ⁷	
Electrical life AC 1	1 x 10 ⁵		1 x 10 ⁵	
Isolation voltage of input / output	6 kV			
Wire range fine-stranded/solid	0.2 - 1.5 mm ² (AWG 24-16)			
Degree of protection / Mounting rail	IP 20 / TS35			
Dimensions (mm) W x H x D	15.8 x 82.9 x 68.1			
Ambient temperature	-25...+70 °C (>12A max 50 °C) -25...+70 °C			
Approvals	CE TÜV US			

flare MOVE MR





- Pluggable coupling relay
- Robust pins
- Switching position is indicated mechanically
- Lockable test button
- For railway application accord. to EN 50 155
- Overall width 27 mm
- Screw terminals
- 4 change-over contacts 7A







Description	Part No.	Std. Pack
flare MOVE MR	4 change-over contact	
24V Relay module DC	80.010.5702.2	10
Replacement relay	Information on request	
Technical data		
Maximum switching voltage	250 V AC	
Maximum switching current	7 A	
Maximum starting current	15 A	
Mechanical life	2 x 10 ⁷	
Electrical life AC 1	1.5 x 10 ⁵	
Isolation voltage of input / output	3.6 kV	
Wire range fine-stranded/solid	0.25 - 4 mm ² (AWG 24-12) / 0.25 - 6 mm ² (AWG 24-10)	
Degree of protection / Mounting rail	IP 20 / TS35	
Dimensions (mm) W x H x D	27 x 76 x 86.9	
Ambient temperature	-40...+70 °C	
Approvals	CE TÜV US	



Coupling relays

<p>flare</p> <ul style="list-style-type: none"> • Compact coupling relay • Overall width 6.2 mm • Screw terminals/ Cage clamp • 1 change-over contact 6 A 	Description		Part No.	Std. Pack	Part No.	Std. Pack	
	flare MOVE		Screw terminal		Cage clamp		
	12V Relay module DC				80.010.4106.0	10	
	24V Relay module DC		80.010.4000.0	10	80.010.4100.0	10	
	115V Relay module AC				80.010.4131.0	10	
	230V Relay module AC				80.010.4141.0	10	
	Pluggable jumper max 2A		Z8.000.0200.8	10			
	Jumper for potential distribution red		Z8.000.0202.3	5			
	Jumper for potential distribution blue		Z8.000.0202.4	5			
	Endcaps for jumper, red		Z8.000.0202.1	20			
	Endcaps for jumper, blue		Z8.000.0202.2	20			
	8 digit marking tag, unmarked, 60 pcs.		Z4.242.5153.0	10			
	Technical data						
	Maximum switching voltage		250 V AC / 300 V DC				
Maximum switching current		6 A AC / 2A DC					
Maximum starting current		10 A					
Mechanical life		1 x 10 ⁷					
Electrical life up to 230V AC / 6A		8 x 10 ⁴					
Isolation voltage of input / output		4 kV _{eff}					
Connectable via pluggable jumper		50 modules					
Wire range fine-stranded/solid		0.5 - 2.5 mm ² (AWG 22 – 14) /		0.25 - 1.5 mm ² (AWG 24 – 16) /			
		0.25 - 4 mm ² (AWG 24 – 12)		0.25 - 2.5 mm ² (AWG 24 – 14)			
Degree of protection / Mounting rail		IP 20 / TS35					
Dimensions (mm) W x H x D		6.2 x 89 x 70					
Ambient temperature		0 ... +60 °C					
Approvals		CE   					

<p>flare</p> <ul style="list-style-type: none"> • Compact coupling relay • Overall width 6.2 mm / 12.4 (2 change-over contacts) • Screw terminals/ Cage clamp • Special Type 	Description		Part No.	Std. Pack	Part No.	Std. Pack	
	flare		Screw terminal		Cage clamp		
	24V Relay module AC/DC		80.010.4005.0	10	80.010.4105.0	10	
	1 change-over contact DC 48V 20mA with gold (3µm)						
	24V Relay module DC				80.010.4103.0	5	
	2 change-over contact AC 250V 6A AC/DC 300 V 2A DC						
	24V Knife edge disconnect relay AC/DC				80.010.4120.0	10	
	1 change-over contact AC 250V 6A / DC 300 V 2 A						
	24V HAND-0-AUTO-Relay				80.010.4101.0	10	
	1 normally open contact AC 250V 6A / DC 300V 2A						
	Technical data						
	Mechanical life		2 x 10 ⁷				
	Electrical life up to 230V AC / 6A		6 x 10 ⁴				
	Isolation voltage of input / output		4 kV _{eff}				
Connectable via pluggable jumper		50 modules					
Wire range fine-stranded/solid		0.5 - 2.5 mm ² (AWG 22 – 14) /		0.25 - 1.5 mm ² (AWG 24 – 16) /			
		0.25 - 4 mm ² (AWG 24 – 12)		0.25 - 2.5 mm ² (AWG 24 – 14)			
Degree of protection / Mounting rail		IP 20 / TS35					
Dimensions (mm) W x H x D		6.2 x 89 x 70 / 12.4 x 89 x 70 (2 change-over contacts)					
Ambient temperature		0 ... +60 °C 6 mm ²					
Approvals		CE   					



Coupling relays

Relay output modules

- Pluggable coupling relay
- Screw terminals
- 1 change-over contact / 2 change-over contacts
- 1 relay up to 16 relays
- 5 A switching capacity per output
- 12 V and 24 V



Description	Part No.	Std. Pack	Part No.	Std. Pack
Relay output modules	1 change-over contact		2 change-over contacts	
12V Module AC/DC 1 relay	87.220.7553.0	10		
24V Module DC 4 relay positive switching	87.220.1853.0	1	87.220.4753.3	1
24V Module DC 4 relay negative switching	87.221.5553.0	1		
24V Module DC 8 relay positive switching	87.220.1953.3	1	87.220.4853.3	1
24V Module DC 16 relay positive switching	87.220.2253.3	1		
Replacement relay	Z8.000.0056.9	10	Z8.000.0035.5	10

Technical data	
Maximum switching voltage	250 V AC/DC
Maximum switching current	5 A AC/DC
Maximum starting current	8 A AC/DC
Mechanical life	3 x 10 ⁷
Electrical life 230V AC / 5A	6 x 10 ⁵
Isolation voltage of input / output	4 kV
Wire range fine-stranded/solid	0.25 - 2.5 mm ² (AWG 24-14) / 0.5 - 4 mm ² (AWG 22-12)
Mounting rail	TS 35 / TS 32
Dimensions (mm) W x H x D	1 relay: 12.5x80x58.3 4/8/16 relay: 70/128/280x80x71
Ambient temperature	-25 ... +50 °C (Derating)
Approvals	CE

Relay output modules

- Pluggable coupling relay
- Screw terminals
- 1 change-over contact 4 A / 2 change-over contacts 5 A
- 1 relay up to 8 relays
- 115 V and 230 V AC/DC



Description	Part No.	Std. Pack	Part No.	Std. Pack
Relay output modules	1 change-over contact		2 change-over contacts	
230 V Module AC/DC 1 relay	80.010.0011.0	10	80.010.1100.0	5
115 V Module AC/DC 4 relay	80.010.1102.0	1	80.010.1104.0	1
115 V Module AC/DC 8 relay	80.010.1110.0	1	80.010.1112.0	1
230 V Module AC/DC 4 relay	80.010.1106.0	1	80.010.1108.0	1
230 V Module AC/DC 8 relay	80.010.1114.0	1	80.010.1116.0	1
Replacement relay	Z8.000.0181.0	10	Z8.000.0176.2	10



Technical data	
Maximum switching voltage	250 V AC/DC
Maximum switching current	4 A AC/DC
Maximum starting current	6 A AC/DC
Mechanical life	3 x 10 ⁷
Electrical life 230V AC/nominal current	1.5 x 10 ⁶
Isolation voltage of input / output	4 kV
Wire range fine-stranded/solid	0.25 - 2.5 mm ² (AWG 24-14) / 0.5 - 4 mm ² (AWG 22-12)
Mounting rail	TS 35 / TS 32
Dimensions (mm) W x H x D	1 relay: 12.5 x 80 x 70 4/8 relay: 70/128 x 80 x 71
Ambient temperature	-40 ... +50 °C (Derating)
Approvals	CE

Coupling relays

Relay system

- Bridgeable relay system
- Screw terminals
- 1 normally open contact/ 1 change-over contact
- 24 V AC/DC





Description	Part No.	Std. Pack	Part No.	Std. Pack
Relay system		Output		Input
24V Module AC/DC 1 normally open contact	80.010.0005.0	10	80.010.0007.0	10
24V Module AC/DC 1 change-over contact	80.010.0008.0	10	80.010.0009.0	10
Pluggable jumper max. 0.5A	Z8.000.0103.4	10		
Technical data				
Maximum switching voltage	250 V AC/DC		48 V DC (10 µm gold)	
Maximum switching current	5 A AC/DC		20 mA	
Maximum starting current	8 A AC/DC			
Mechanical life	3 x 10 ⁷		3 x 10 ⁷	
Electrical life (up to nominal rating)	2.5 x 10 ⁵		3 x 10 ⁶	
Isolation voltage of input / output	4 kV			
Wire range fine-stranded/solid	0.5 - 2.5 mm ² (AWG 22-14) / 0.5 - 4 mm ² (AWG 22-12)			
Mounting rail	TS 35 / TS 32			
Dimensions (mm) W x H x D	12.5 x 80 x 60			
Ambient temperature	-25 ... +50 °C (Derating up to 65 °C)			
Approvals	CE   			

Relay system

- Bridgeable relay system
- Screw terminals
- 2 change-over contacts 5 A
- 24 V AC/DC





Description	Part No.	Std. Pack	Part No.	Std. Pack
Relay system		Output		Input
24V Module AC/DC 2 change-over contacts	80.010.1003.0	5	80.010.1002.0	5
Pluggable jumper max. 0.5 A	Z8.000.0103.4	10		
Technical data				
Maximum switching voltage	250 V AC/DC		48 V DC (10 µm gold)	
Maximum switching current	5 A AC/DC		20 mA	
Maximum starting current	6 A AC/DC			
Mechanical life	3 x 10 ⁷		3 x 10 ⁷	
Electrical life (up to nominal rating)	2.5 x 10 ⁵		3 x 10 ⁶	
Isolation voltage of input / output	4 kV			
Wire range fine-stranded/solid	0.5 - 2.5 mm ² (AWG 22-14) / 0.5 - 4 mm ² (AWG 22-12)			
Mounting rail	TS 35 / TS 32			
Dimensions (mm) W x H x D	22.5 x 80 x 60			
Ambient temperature	-25 ... +50 °C			
Approvals	CE   			

Relay system

- Bridgeable relay system
- Screw terminals
- 1 change-over contact 16 A
- 24 V AC/DC



Description	Part No.	Std. Pack
Relay system		Output
24 V Module AC/DC 1 change-over contact	80.010.0010.0	5
Pluggable jumper max. 0.5 A	Z8.000.0103.4	10
Technical data		
Maximum switching voltage	250 V AC/DC	
Maximum switching current	16 A AC/DC	
Maximum starting current	16 A AC/DC	
Mechanical life	3 x 10 ⁷	
Electrical life (up to nominal rating)	1.8 x 10 ⁵	
Isolation voltage of input / output	4 kV	
Wire range fine-stranded/solid	0.5 - 2.5 mm ² (AWG 22-14) / 0.5 - 4 mm ² (AWG 22-12)	
Mounting rail	TS 35 / TS 32	
Dimensions (mm) W x H x D	22.5 x 80 x 60	
Ambient temperature	-25 ... +50 °C (Derating up to 65 °C)	
Approvals	CE   	





Solid-State relays

flare

- Compact solid-state relay
- Overall width 6.2 mm
- Spring cage clamp
- Output 48 V DC





Description	Part No.	Std. Pack	Part No.	Std. Pack
flare	Output 0,5 A		Output 2 A	
24 V Module DC / Output 48 V	80.020.4100.0	10	80.020.4101.0	10
115 V Module AC/DC / Output 48 V	80.020.4102.0	10		
230 V Module AC/DC / Output 48 V	80.020.4103.0	10		
Pluggable jumper max 2 A	Z8.000.0200.8	10		
8 digit marking tag, unmarked, 60 pcs.	Z4.242.5153.0	10		
Technical data				
Maximum switching voltage	48 V DC (4,4...53 V DC)			
Maximum switching current	0,5 A		2 A	
Min. switching current	0,1 mA		1 mA	
Isolation voltage of input / output	3,75 kV			
Connectable via pluggable jumper	50 modules			
Wire range fine-stranded/solid	0,25 -1,5 (AWG 24-16) / 0,25 - 2,5 mm ² (AWG 24-14)			
Degree of protection / Mounting rail	IP 20 / TS35			
Dimensions (mm) W x H x D	6,2 x 89 x 70			
Ambient temperature	0 ... +50 °C (Derating)			
Approvals	CE   			

flare

- Compact solid-state relay
- Overall width 6.2 mm
- Spring cage clamp
- Output 230 V AC





Description	Part No.	Std. Pack	Part No.	Std. Pack
flare	Output 0,5 A			
24V Module DC / Output 230 V AC	80.020.4150.0	10		
Pluggable jumper max 2 A	Z8.000.0200.8	10		
8 digit marking tag, unmarked, 60 pcs.	Z4.242.5153.0	10		
Technical data				
Maximum switching voltage	250 V AC			
Maximum switching current	0,5 A			
Min. switching current	0,1 mA			
Isolation voltage of input / output	2,5 kV			
Connectable via pluggable jumper	50 modules			
Wire range fine-stranded/solid	0,25 -1,5 mm ² (AWG 24-16) / 0,25 - 2,5 mm ² (AWG 24-14)			
Degree of protection / Mounting rail	IP 20 / TS35			
Dimensions (mm) W x H x D	6,2 x 89 x 70			
Ambient temperature	0 ... +50 °C (Derating)			
Approvals	CE   			

Solid-state relay

- Bridgeable
- Screw terminals
- Output 60 V DC





Description	Part No.	Std. Pack	Part No.	Std. Pack
Solid-State-Relay	Output 3 A		Output 5 A	
24 V Module DC / Output 48 V	80.020.2003.0	10	80.020.2004.0	10
Pluggable jumper	Z8.000.0103.4	10		
Technical data				
Maximum switching voltage	60 V DC (3...60 V)			
Maximum switching current	3 A DC (Derating)		5 A DC	
Min. switching current	20 mA			
Isolation voltage of input / output	4 kV			
Connectable via pluggable jumper	20 modules			
Wire range fine-stranded/solid	0,5 -2,5 mm ² (AWG 22-14) / 0,5 - 4 mm ² (AWG 22-12)			
Mounting rail	TS 35 / TS 32			
Dimensions (mm) W x H x D	12,5 x 80 x 64		12,5 x 80 x 59	
Ambient temperature	-20 ... +50 °C (Derating)			
Approvals	CE  			

Solid-state relay

- Bridgeable
- Screw terminals
- Output 250 V AC



Description	Part No.	Std. Pack	Part No.	Std. Pack
Solid-State-Relay	Output 4 A		Output 6 A	
24 V Module DC / Output 250 V AC	80.020.2001.0	10	80.020.0004.0	10
Pluggable jumper	Z8.000.0103.4	10		
Technical data				
Maximum switching voltage	280 V AC (48...280 V)			
Maximum switching current	4 A		6 A	
Min. switching current	60 mA			
Isolation voltage of input / output	4 kV			
Connectable via pluggable jumper	20 modules			
Wire range fine-stranded/solid	0,5 -2,5 mm ² (AWG 22-14) / 0,5 - 4 mm ² (AWG 22-12)			
Mounting rail	TS 35 / TS 32			
Dimensions (mm) W x H x D	12,5 x 80 x 56		25,6 x 80 x 70	
Ambient temperature	-25 ... +50 °C (Derating)			
Approvals	CE  			



Analog Isolation Amplifier

flexible and precise

Analog isolation amplifier of the **cores** series

The **cores** series convinces with flexible use in process and industrial automation.

They ensure a defined separation of measurement and process signals from the control system. And it protects against voltage drops.

Analogue isolation amplifiers also convert signals into standardized signal levels.

cores combines a highly precise signal conversion with a very small housing and fulfils actual demands for such products.

The Advantages:

- Digital conversion (up to 16 Bit)
- Highest accuracy (0.1 %) and linearity
- Fastest reaction time (from 11 ms)
- 3 or 4 way galvanic isolation
- High isolation voltage
- Compact housing (also as thin as 6.2 mm)
- Universal functions settable
- Wide temperature range



Analog Isolation Amplifier

cores C1 UI-B

- Analog Isolation Amplifier
- 3 way isolation
- Input: voltage / current, output: voltage / current
- High accuracy by digital conversion
- Width 6.2 mm
- Spring clamp connection
- Wide temperature range



Type	Part No.
cores C1 UI-B	82.003.0110.0
Technical data	
Input range (adjustable)	0/1 ... 5 V DC or 0/2 ... 10 V DC 0/4 ... 20 mA DC
Output range (adjustable)	0/1 ... 5 V DC or 0/2 ... 10 V DC 0/4 ... 20 mA DC or 20 ... 4/0 mA DC active or passive
Galvanic isolation	yes, 3 way isolation
Isolation voltage	1500 V AC
Accuracy	<0.1%, 14 Bit resolution
Supply voltage range	19.2 ... 30 V DC
Power consumption	max. 500 mW
Connection type	Spring clamp
Wire range solid/fine-stranded	0.2 - 2.5 mm ² (AWG 24-14)
Degree of protection / Mounting rail	IP 20 / TH 35 (EN60715)
Dimensions (mm) W x H x D	6.2 x 93.1 x 102.5
Temperature range	-20 ... +65 °C
Approvals (pending)	CE 

cores C1 PT-B

- Analog Isolation Amplifier
- 3 way isolation
- Input: PT 100, output: voltage / current
- High accuracy by digital conversion
- Width 6.2 mm
- Spring clamp connection
- Wide temperature range



Type	Part No.
cores C1 PT-B	82.003.0120.0
Technical data	
Input range (adjustable)	PT100 with 2-, 3- or 4 wire connection -150 ... +650 °C
Output range (adjustable)	0/1 ... 5 V DC or 0 ... 10 V; 10 ... 0 V DC 0/4 ... 20 mA DC or 20 ... 4/0 mA DC
Galvanic isolation	yes, 3 way isolation
Isolation voltage	1500 V AC
Accuracy	<0.1%, 14 Bit resolution
Supply voltage range	19.2 ... 30 V DC
Power consumption	max. 500 mW
Connection type	Spring clamp
Wire range solid/fine-stranded	0.2 - 2.5 mm ² (AWG 24-14)
Degree of protection / Mounting rail	IP 20 / TH 35 (EN60715)
Dimensions (mm) W x H x D	6.2 x 93.1 x 102.5
Temperature range	-20 ... +65 °C
Approvals (pending)	CE 

cores C1 TC-B

- Analog Isolation Amplifier
- 3 way isolation
- Input: thermo coupler, output: voltage / current
- High accuracy by digital conversion
- Width 6.2 mm
- Spring clamp connection
- Wide temperature range



Type	Part No.
cores C1 TC-B	82.003.0130.0
Technical data	
Input range (adjustable)	Types of thermo coupler: J, K, E, N, S, R, B, T
Output range (adjustable)	0/1 ... 5 V DC oder 0 ... 10 V DC 0/4 ... 20 mA DC oder 20 ... 4/0 mA DC
Galvanic isolation	yes, 3 way isolation
Isolation voltage	1500 V AC
Accuracy	<0.1%, 14 Bit resolution
Supply voltage range	19.2 ... 30 V DC
Power consumption	max. 500 mW
Connection type	Spring clamp
Wire range solid/fine-stranded	0.2 - 2.5 mm ² (AWG 24-14)
Degree of protection / Mounting rail	IP 20 / TH 35 (EN60715)
Dimensions (mm) W x H x D	6.2 x 93.1 x 102.5
Temperature range	-20 ... +65 °C
Approvals (pending)	CE 

Analog Isolation Amplifier

cores C2 UI-A

- Analog Isolation Amplifier
- 3 way isolation
- Input: current, output: current
- High accuracy by digital conversion
- Width 17.5 mm
- Screw clamp pluggable
- Wide temperature range



Type	Part No.
cores C2 UI-A	82.003.0210.0
Technical data	
Input range (adjustable)	0 ... 20 mA DC active or passive
Output range (adjustable)	0 ... 20 mA DC active or passive
Galvanic isolation	yes, 3 way isolation
Isolation voltage	1500 V AC
Accuracy	<0.1%
Reaction time	<40 ms
Supply voltage range	9 ... 40 V DC, 19 ... 28 V AC
Power consumption	max. 2.5 W
Connection type	Screw clamp pluggable
Wire range solid/fine-stranded	0.14 - 2.5 mm ² (AWG 26-14)
Degree of protection / Mounting rail	IP 20 / TH 35 (EN60715)
Dimensions (mm) W x H x D	17.5 x 100 x 112
Temperature range	-20 ... +60 °C
Approvals (pending)	CE

cores C2 M-A

- Analog Isolation Amplifier
- 3 way isolation
- Input: voltage, current, thermo coupler, potentiometer, output: voltage, current
- High accuracy by digital conversion
- Width 17.5 mm
- Screw clamp pluggable
- Wide temperature range



Type	Part No.
cores C2 M-A	82.003.0200.0
Technical data	
Input range (adjustable)	75 mV ... 20 V in 9 ranges (bipolar) 0 ... 20 mA (bipolar) J,K,R,S,T,B,E,N Thermo coupler Pt100, Pt500, Pt1000, Ni100. 3 or 4 wire 500 Ohm ... 10 kOhm Potentiometer 500 Ohm ... 25 kOhm Rheostat
Output range (adjustable)	0 ... 20 mA oder 4 ... 20 mA 0... 5V oder 0 ... 10V oder 1 ... 5V oder 2 ... 10V
Galvanic isolation	yes, 3 way isolation
Isolation voltage	1500 V AC
Accuracy	<0.1%, 12 or 16 Bit resolution
Reaction time	<35 ms (at 12 Bit) and <140 ms (at 16 Bit)
Supply voltage range	10 ... 40 V DC, 19 ... 28 V AC
Power consumption	max. 2.5 W
Connection type	Screw clamp pluggable
Wire range solid/fine-stranded	0.14 - 2.5 mm ² (AWG 26-14)
Degree of protection / Mounting rail	IP 20 / TH 35 (EN60715)
Dimensions (mm) W x H x D	17.5 x 100 x 112
Temperature range	-10 ... +60 °C
Approvals (pending)	CE

cores C2 M2-A

- Analog Isolation Amplifier
- 4 way isolation
- 2 analogue outputs
- Input: voltage, current, thermo coupler, potentiometer, output: voltage, current
- High accuracy by digital conversion
- Width 17.5 mm
- Screw clamp pluggable
- Wide temperature range



Type	Part No.
cores C2 M2-A	82.003.0250.0
Technical data	
Input range (adjustable)	0 ... +10V 0 ... 20mA active or passive J, K, R, S, T, B, E, N Thermo coupler Pt100, Pt500, Pt1000, Ni100. 2, 3, 4 wire 1 ... 100 kOhm Potentiometer 500 Ohm ... 25 kOhm Rheostat
Output range (adjustable)	0 ... 20 mA or 4 ... 20 mA active or passive 0 ... +10 V
Galvanic isolation	yes, 4 way isolation
Isolation voltage	1500 V AC
Accuracy	<0.1%, 14 Bit resolution
Reaction time	<11 ms
Supply voltage range	10 ... 40 V DC, 19 ... 28 V AC
Power consumption	max. 2 W
Connection type	Screw clamp pluggable
Wire range solid/fine-stranded	0.14 - 2.5 mm ² (AWG 26-14)
Degree of protection / Mounting rail	IP 20 / TH 35 (EN60715)
Dimensions (mm) W x H x D	17.5 x 100 x 112
Temperature range	-10 ... +65 °C
Approvals (pending)	CE



Timers

Always up to the minute

The electronic relays are ideally suited for standard, monitoring and control tasks in order to control function processes down to the second. Depending on the application, multiple-voltage and multi-functional relays are available.

Decades of timer know-how are packed into a completely new, highly miniaturized generation of timers just 22.5 mm wide. Although the end of the timer has been being predicted for years now, as the PLC has spread, high quality timers with well thought-out designs and universal application will continue to be needed in industrial automation.



Timers remain crucial – in less complex series machines, in later modifications, everywhere where other solutions would result in unnecessary engineering and hardware costs. For these applications Wieland offers a range of timers that provides everything you need. These devices unite diverse features with an efficiency that permits the fullest profitability – from procurement and warehousing through application and operation, and finally to disposal.



Variable input voltage

The activation of the excitation input B1 can be done with any voltage levels from AC/DC 20.4 V to 264 V.

Remote Control (optional)

Connecting an optional remote potentiometer means that a number of devices can be time-setting enabled over large distances without requiring access to the control cabinet. Operation without a remote potentiometer does not require a bridge at the relay.



Assembly



1. Hook the housing onto the DIN rail
2. Snap the housing onto the DIN rail by gently pressing it in the direction of the arrow

Disassembly

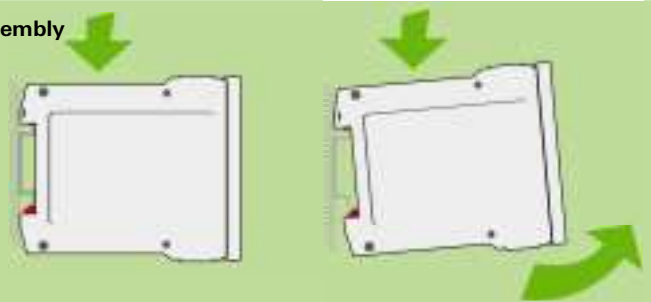

1. Press down the housing in the direction of the arrow
2. Release the housing from its latched position by holding it down and moving it in the direction of the arrow, and remove it from the DIN rail

Multiple-voltage ergonomic and mobile

flare TIME series of timer relays

Our **flare** TIME family features universal application in the industrial automation sector. Up to 8 functions in just one relay cover all of your requirements and reduce inventory costs as well. Existing production processes can be easily expanded thanks to our **flare** TIME timer relay series, without incurring additional engineering and hardware costs. Our timer relays can be used in bakery machines, industrial washing machines, elevators and escalators, access controls and much more.

Features:

- Ambient temperatures from -25 °C to +60 °C
- Very high interference voltage resistance
- Output relays correspond to utilization category AC-15 and DC-13

The advantages:

- ① Power LED with progress display
- ② Function setting
- ③ Time range setting
- ④ Clear time setting
- ⑤ LED as status indicator of the change-over contact
- ⑥ Double connection points internally connected (HM series)

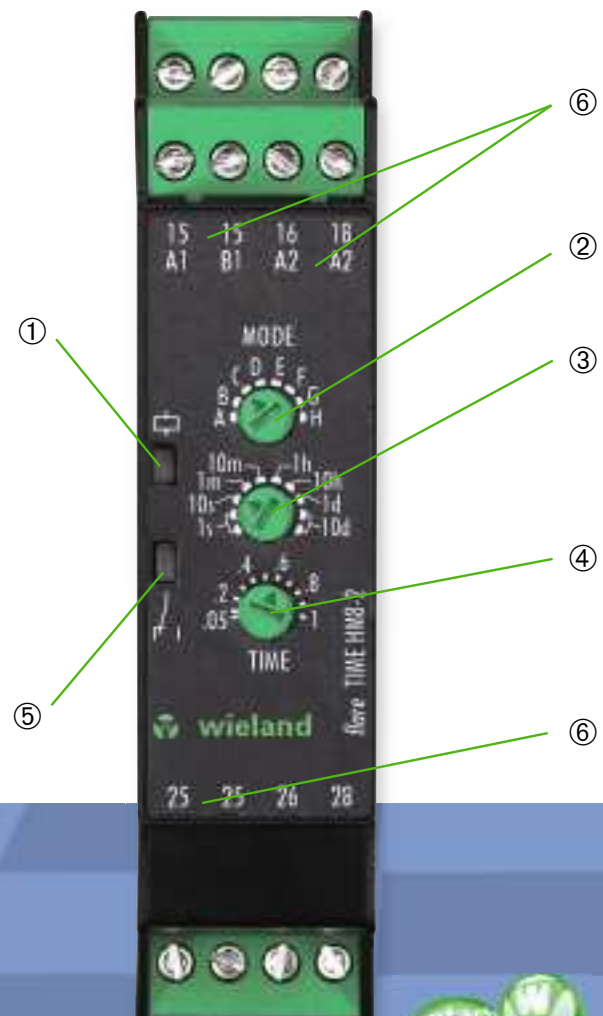



Electronic timer and switching relays for DIN rails



Electromechanical timer and switching relays for DIN rails



Electronic timer and switching relays for panel mounting



Electromechanical timer and switching relays for panel mounting

! Further products and technical details can be found at www.wieland-electric.com in our e-catalog.



Electronic timer and switching relays for DIN rails Multifunction

Description		flare TIME HM8-2-A	flare TIME HM8-2P-A	flare TIME HM5-1-A	flare TIME M8-2	flare TIME M8-1	flare TIME M4-2	flare TIME M4-1	flare TIME-S
Part no.		81.020.0104.0	81.020.0134.0	81.020.0100.0	81.020.0003.0	81.020.0002.0	81.020.0001.0	81.020.0000.0	81.020.4100.0
Model	Multi-function	•	•	•	•	•	•	•	•
	Multi-range	•	•	•	•	•	•	•	•
Function									
Timer relays	ON-delay	•	•	•	•	•	•	•	•
	OFF-delay	•	•		•	•			•
	ON-delay- and OFF-delay, symmetrical	•	•		•	•			
Interval ON relay	Interval ON	•	•	•	•	•	•	•	•
	Interval OFF								
	Interval ON and Interval OFF	•	•		•	•			
Repeat cycle timer	OFF start, symmetrical and selectable	•	•	•	•	•			•
	ON start, symmetrical and selectable	•	•	•	•	•	•	•	•
	ON start, symmetrical and fixed								
	OFF start and ON start, symmetrical and fixed, cycle time setting range								
Star-delta relay	Switch-over relay, Interval ON								
Pulse relay	Pulse relay, ON-delay, Pulse output	•	•	•	•	•	•	•	
	Pulse relay, OFF start, OFF start selectable, ON time fixed								
	Pulse relay, alternating, OFF or ON time selectable								
	One shot (interval ON)								
Contacts	Timed change-over contact	2	2	1	2 ¹⁾	1	2 ¹⁾	1	1
	Instantaneous change-over contact				1 ¹⁾		1 ¹⁾		
Rated Voltage	Multi-voltage AC/DC 24 to 230 (240) V	•	•	•	•	•	•	•	
Special Features	Remote potentiometer connection		•						
	Double connection points (internally connected) for trough cabling	•	•	•					
	Digital (D) or analog (A) settings	A	A	A	A	A	A	A	
Housing	Surface mounting 22.5 mm	•	•	•	•	•	•	•	

1) = 1 timed and 1 instantaneous change-over contact or 2 timed change-over contacts, selectable



Electronic timer and switching relays for DIN rails

flare TIME M

- Multi-function timer
- Multi-range time
- Wide input voltage range 20.4 ... 264 V AC/DC
- 4 or 8 selectable time functions
- 1 or 2 change-over contacts 5 A



Type	Part No.
flare TIME M4-1 (4 time ranges / 1 contacts)	81.020.0000.0
flare TIME M4-2 (4 time ranges / 2 contacts)	81.020.0001.0
flare TIME M8-1 (8 time ranges / 1 contacts)	81.020.0002.0
flare TIME M8-2 (8 time ranges / 2 contacts)	81.020.0003.0
Technical data	
Input voltage range	20,4 ... 264 V AC/DC
Time range	0.1 s ... 1200 h
Time functions	4 or 8
Number of change-over contacts	1 or 2
Maximum switching current	5 A
Mechanical life time	10 x 10 ⁶
Electrical life time AC1	0.1 x 10 ⁶
Isolation voltage of input/output	2 kV
Connection clamps	Screw clamp
Wire range fine-stranded/solid	0.14 - 2.5 mm ² (AWG 26-14)
Degree of protection / mounting rail	IP 20 / TH 35 (EN60715)
Dimensions (mm) W x H x D	22.5 x 89.4 x 100
Operation temperature range	-20 ... +55 °C
Approvals	CE

flare TIME HM

- Multi-function timer
- Multi-range time
- Wide input voltage range 20.4 ... 264 V AC/DC
- 5 or 8 selectable time functions
- Pluggable clamps
- Wide temperature range
- 1 or 2 change-over contacts 5 A



Type	Part No.
flare TIME HM5-1-A (5 time ranges / 1 contacts)	81.020.0100.0
flare TIME HM8-2-A (8 time ranges / 2 contacts)	81.020.0104.0
flare TIME HM8-2P-A (with remote control connection)	81.020.0134.0
Technical data	
Input voltage range	20,4 ... 264 V AC/DC
Time range	0.05 s ... 240 h
Time functions	5 or 8
Number of change-over contacts	1 or 2
Maximum switching current	5 A
Mechanical life time	20 x 10 ⁶
Electrical life time AC1	0.1 x 10 ⁶
Isolation voltage of input/output	2 kV
Connection clamps	Pluggable screw clamp
Wire range fine-stranded/solid	0.2 - 2.5 mm ² (AWG 24-14)
Degree of protection / mounting rail	IP 20 / TH 35 (EN60715)
Dimensions (mm) W x H x D	22.5 x 96.5 x 81.5
Operation temperature range	-25 ... +60 °C
Approvals	CE

flare TIME TWIN-1

- Multi-range repeat cycle timer
- Multi-range time
- ON- or OFF-start settable
- Time ON and OFF separate adjustable
- Wide input voltage range 20.4 ... 264 V AC/DC
- 1 change-over contacts 5 A



Type	Part No.
flare TIME TWIN-1	81.020.0011.0
Technical data	
Input voltage range	20,4 ... 264 V AC/DC
Time range	0.1 s ... 1200 h
Time functions	ON- or OFF-start
Number of change-over contacts	1
Maximum switching current	5 A
Mechanical life time	10 x 10 ⁶
Electrical life time AC1	0.1 x 10 ⁶
Isolation voltage of input/output	2 kV
Connection clamps	Screw clamp
Wire range fine-stranded/solid	0.14 - 2.5 mm ² (AWG 26-14)
Degree of protection / mounting rail	IP 20 / TH 35 (EN60715)
Dimensions (mm) W x H x D	22.5 x 89.4 x 100
Operation temperature range	-20 ... +55 °C
Approvals	CE

Electronic timer and switching relays for DIN rails

flare TIME OFF-1

- OFF delayed timer
- No auxiliary voltage necessary
- 2 time ranges settable
- 1 change-over contacts 5 A



Type	Part No.
flare TIME OFF-1	81.020.0010.0
Technical data	
Input voltage range	170 ... 264 V AC
Time range	1 ... 120 s
Time functions	OFF delay
Number of change-over contacts	1
Maximum switching current	5 A
Mechanical life time	10 x 10 ⁶
Electrical life time AC1	0.1 x 10 ⁶
Isolation voltage of input/output	2 kV
Connection clamps	Screw clamp
Wire range fine-stranded/solid	0.14 - 2.5 mm ² (AWG 26-14)
Degree of protection / Mounting rail	IP 20 / TH 35 (EN60715)
Dimensions (mm) W x H x D	22.5 x 89.4 x 100
Operation temperature range	-20 ... +55 °C
Approvals	CE

flare TIMER-S

- Multi-function timer
- ON-delay and OFF-delay
- One shot and flashing
- Spring clamp
- Width 6.2 mm
- 1 change-over contacts 6 A



Type	Part No.
flare TIMER-S-250250V6A	81.020.4100.0
Technical data	
Input voltage range	24 V DC +25%/-20%
Time range	0.1 ... 300 s
Number of change-over contacts	1
Maximum switching current	6 A
Mechanical life time	2 x 10 ⁷
Electrical life time at 24 V DC / 2 A	0.6 x 10 ⁶
Electrical life time at 230 V AC / 6 A	0.8 x 10 ⁵
Isolation voltage of input/output	4 kV
Connection clamps	Spring clamp
Wire range fine-stranded/solid	0.25 - 1.5 mm ² (AWG 24-16) / 0.25 - 2.5 mm ² (AWG 24-14)
Degree of protection / Mounting rail	IP 20 / TH 35 (EN60715)
Dimensions (mm) W x H x D	6,2 x 89 x 70mm
Operation temperature range	0 ... +50 °C
Approvals	

flare TIMER-A

- Timer
- ON-delay
- Spring clamp
- Width 6.2 mm
- 1 change-over contacts 6 A



Type	Part No.
flare TIMER-A/0100-S-250V6A	81.020.4101.0
flare TIMER-A/0060-S-250V6A	81.020.4102.0
Technical data	
Input voltage range	24 V DC +25%/-20%
Time range TIMER A/0100	1 ... 100 s
Time range TIMER A/0060	1 ... 100 min
Number of change-over contacts	1
Maximum switching current	6 A
Mechanical life time	2 x 10 ⁷
Electrical life time at 24 V DC / 2 A	0.6 x 10 ⁶
Electrical life time at 230 V AC / 6 A	0.8 x 10 ⁵
Isolation voltage of input/output	4 kV
Connection clamps	Spring clamp
Wire range fine-stranded/solid	0.25 - 1.5 mm ² (AWG 24-16) / 0.25 - 2.5 mm ² (AWG 24-14)
Degree of protection / Mounting rail	IP 20 / TH 35 (EN60715)
Dimensions (mm) W x H x D	6,2 x 89 x 70mm
Operation temperature range	0 ... +50 °C
Approvals	



Electromechanical Timer and switching relays for DIN rails

ON-delay multi-range electro-mechanical timer relays
SZA 52-S / SZA 52 / SZAN 52-S / SZA 54-2S



- Devices for single voltage
- Function: ON-delay (AV), SZAN 52-S protected against power failure
- 1 setting range divided into 6 time ranges
- Contact assignment:
 - SZA 52-S = 1 timed and 1 instantaneous change-over contact
 - SZAN 52-S = 1 timed and 1 instantaneous change-over contact
 - SZA 52 = 2 timed change-over contact
 - SZA 54-2S = 1 timed and 1 instantaneous normally closed contact (NC)
1 timed and 1 instantaneous normally open contact (NO)

OFF-delay multi-range electro-mechanical timer relay with auxiliary supply,
SZA 521



- Devices for single voltage
- function: OFF-delay (RV)
- 1 setting range divided into 6 time ranges
- Contact assignment: 1 timed and 1 instantaneous change-over contact

Electromechanical multi-range repeat cycle timer
SPZA 52



- Function: repeat cycle timer (TI) starting with ON
- ON and OFF times can be selected independently of one another
- 1 setting range divided into 6 time ranges
- Contact assignment: 1 normally open, 1 normally closed

Electromechanical stepping relay
SSF 32 / SSF 52 / SSF 62



- Devices for single voltage
- Function: stepping relay
- Contact assignment:
 - SSF 32 = 2 NO contacts, simultaneously switched in an ON-OFF cycle
 - SSF 52 = 1 NO contact and 1 NC contact, reciprocally switched in an ON-OFF cycle
 - SSF 62 = 1 NO contact and 1 NC contact, reciprocally switched in an ON-OFF cycle

Electromechanical latching relay
SSP 56 / SSP 72 / SSP 33 / SSP 34



- Devices for single voltage
- Function: Latching relay
- Contact assignment:
 - SSP 56 = 3 NO contact and 3 NC contact
 - SSP 72 = 2 change-over contact
 - SSP 33 = 3 change-over contact
 - SSP 34 = 4 change-over contact

Detailed information can be found in our e-catalogue at <http://eshop.wieland-electric.com>

Electronic timer and switching relays for panel mounting

flare TIME FM15-1

- Multi-function timer
- High-contrast color display
- 15 time functions
- Front panel mounting 48 x 48 mm
- Wide temperature range
- 1 change-over contact 5 A



Type	Part No.	
flare TIME FM15-1 (24 V)	81.020.0020.0	
flare TIME FM15-1 (230 V)	81.020.0021.0	
Technical data		
Input voltage range	4.5...30 V DC	85...264 V AC/DC
Time range	0.001 s ... 999 h	
Time functions	15	
Number of change-over contacts	1	
Maximum switching current	5A	
Mechanical life time	10 x 10 ⁶	
Electrical life time AC1	0.1 x 10 ⁶	
Isolation voltage of input/output	2 kV	
Connection clamps	Screw clamp	
Wire range fine-stranded/solid	0.14 - 2,5 mm ² (AWG 26 - 14)	
Degree of protection	IP20 / IP 66 (optional)	
Dimensions (mm) W x H x D	48 x 48 x 65	48 x 48 x 85,5
Operation temperature range	-10 ... +55 °C	
Approvals	CE 	



Electromechanical timer and switching relays for panel mounting

**ON-delay
single-range timer relay,
electromechanical
DZ 12-S L*) / DZN 12-S L**



- Devices for single voltage
- Function: ON-delay (AV), DZN 12-S L protected against power failure
- 1 time range
- Contact assignment: 1 timed and 1 instantaneous change-over contact
- Cover: 72 x 72 mm
- Panel cutout: □ 68 mm
- Push-on connections 6.3 mm

**ON-delay
multi-range electromechanical
timer relay
DZ 52-S G**



- Device for single voltage
- Function: ON-delay (AV)
- 1 Setting range, divided into 5 oder 6 time ranges
- Contact assignment: 1 timed change-over contact and 1 instantaneous NO contact
- Cover: 72 x 72 mm
- Panel cutout: □ 68 mm

**ON-delay
multi-range electromechanical
timer relay,
for burner control system
DZR 52-S L**



- Device for single voltage
- Function: ON-delay (AV) for burner control system
- 1 Setting range divided into 5 or 6 time ranges
- Contact assignment: 1 timed and 1 instantaneous change-over contact
- Cover: 72 x 72 mm
- Panel cutout: □ 68 mm
- Push-on connections 6.3 mm

**ON-delay
multi-range electromechanical
timer relay
DZ 52-S L / DZN 52-S L**



- Devices for single voltage
- Function: ON-delay (AV), DZN 52-S L protected against power failure
- 1 setting range divided into 5 or 6 time ranges
- Contact assignment: 1 timed and 1 instantaneous change-over contact
- Cover: 72 x 72 mm
- Panel cutout: □ 68 mm
- Push-on connections 6.3 mm

**ON-delay
multi-range electromechanical
timer relay
DZA 52-S L / DZA 53-S L
DZAN 52-S L / DZA 52 L**



- Devices for single voltage
- Function: ON-delay (AV), DZAN 52-S L protected against power failure
- 1 setting range divided into 6 time ranges
- Contact assignment:
 - DZA 52-S L = 1 timed and 1 instantaneous change-over contact
 - DZAN 52-S L = 1 timed and 1 instantaneous change-over contact
 - DZA 53-S L = 2 timed change-over contact and 1 instantaneous NO contact
 - DZA 52 L = 2 timed change-over contact
- Cover: 72 x 72 mm
- Panel cutout: □ 68 mm
- Push-on connections 6.3 mm

Electromechanical timer and switching relays for panel mounting

**ON-delay
multi-range electromechanical
timer relay
DZ 74-2S L**



- Devices for single voltage
- Function: ON-delay (AV)
- 1 setting range divided into 6 time ranges
- Contact assignment:
1 timed NC contact,
1 instantaneous and 1 timed NO contact
- without time accumulation
- Cover: 96 x 96 mm
- Panel cutout: □ 91 mm
- Push-on connections 6.3 mm

**ON-delay
multi-range electromechanical
timer relay
DZ 72-S / DZ 74-2S**



- Devices for single voltage
- Function: ON-delay (AV)
- 1 setting range divided into 5 or 6 time ranges
- Contact assignment:
DZ 72-S = 1 timed and 1 instantaneous
change-over contact
DZ 74-2S = 1 instantaneous and 1 timed NC contact, 1
instantaneous and 1 timed NO contact
- Cover: 96 x 96 mm
- Panel cutout: □ 91 mm

**ON-delay
single-range electromechanical
timer relay,
for burner control system
DZR 12-S L**



- Devices for single voltage
- Function: ON-delay (AV) for burner control system
- 1 time range
- Contact assignment: 1 timed and 1 instantaneous
change-over contact
- Cover: 72 x 72 mm
- Panel cutout: □ 68 mm
- Push-on connections 6.3 mm

**OFF-delay
multi-range electromechanical
timer relay
DZ 521 L**



- Devices for single voltage
- Function: OFF-delay (RV)
- 1 setting range divided into 5 or 6 time ranges
- Contact assignment: 1 timed and 1 instantaneous
change-over contact
- Cover: 72 x 72 mm
- Panel cutout: □ 68 mm
- Push-on connections 6.3 mm

**OFF-delay
multi-range electromechanical
timer relay
DZA 521 L**



- Devices for single voltage
- Function: OFF-delay (RV)
- 1 setting range divided into 6 time ranges
- Contact assignment: 1 timed and 1 instantaneous
change-over contact
- Cover: 72 x 72 mm
- Panel cutout: □ 68 mm
- Push-on connections 6.3 mm
- New housing concept

Detailed information can be found in our e-catalogue at <http://eshop.wieland-electric.com>

Type at search the product family name, e.g. DZ12 (without blank)



Measuring & control

precise and safe

Always live

Electronic measuring and monitoring relays for measuring input values such as current, voltage, 3-phases, cos phi, temperature. They carry out both simple and complex monitoring in machines and systems.



Features:

- The optimum device for every monitoring task
- Voltage, current, phase sequence, phase error, temperature or cos phi
- Broad temperature range
- Gold-plated switching contacts for maximum operational reliability



Benefits

- Upper and lower threshold separately adjustable
- 3 measuring ranges (single phase)
- Closed circuit or operating circuit principle
- Time delay 0 ... 10 s adjustable
- Wide input voltage range 20.4 ... 264 V AC/DC
- Width 22.5 mm
- Pluggable screw clamps
- Wide temperature range



Multi-functional measuring relay

economical and flexible

Measuring relays **flare** CONTROL

The product family **flare** CONTROL convinces by the universal use in industrial automation.

All functions required for measuring relays are combined in one device. Only one type for current and voltage measurement is necessary.

This simplifies engineering and reduces stock.

Features:

- ① 3 measuring ranges in one device
- ② Power LED
- ③ Adjustable for closed circuit or operating circuit principle
In additional also time delay for exceeding the threshold
- ④ LED for exceedance of the threshold value
- ⑤ One terminal for supply voltage
- ⑥ Upper threshold in percent of measuring range
- ⑦ Lower threshold in percent of upper threshold
- ⑧ 2 change over contacts simultaneously switching, one change-over contact output per terminal

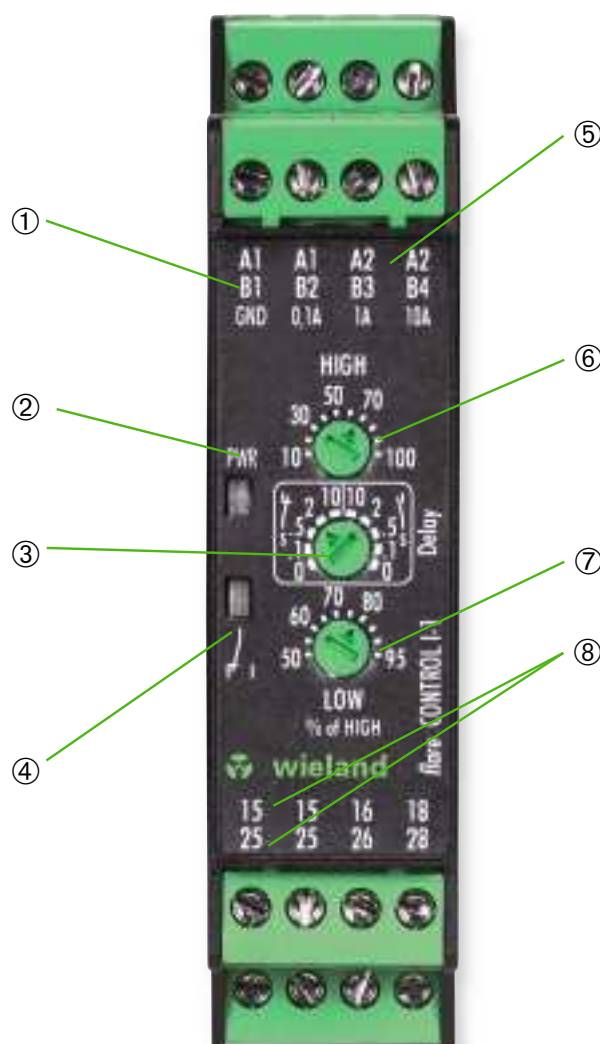

Measuring relay

flare CONTROL U-1-A

- Multi-function measuring relay
- Upper and lower threshold separately adjustable
- 3 measurement ranges (single phase)
- Signal shape DC and sinus
- Closed circuit or operating circuit principle
- Time delay at exceeding the threshold adjustable
- Wide input voltage range 20,4 ... 264 V AC/DC
- Width 22.5 mm
- Pluggable screw clamps
- Wide temperature range
- 2 change-over contacts 5 A



Type	Part No.
flare CONTROL U-1-A	81.030.0100.0
Technical data	
Measuring ranges	5 / 50 / 300 V
Upper threshold	10...100 % of measuring range
Lower threshold	50 ... 95 % of upper threshold
Signal shape	DC and sinus
Nominal frequency of measured signal at AC	45 ... 400 Hz
Nominal power	app. 2 W / 4 VA
Supply voltage range	20.4 ... 264 V AC/DC
Galvanic isolation toward supply	Yes
Functions	Closed circuit or operating circuit principle
Time delay at exceeding the threshold	0 / 0.1 / 0.5 / 2 / 10 s
Number of change-over contacts	2 (simultaneously switching)
Maximum switching current	5 A
Mechanical life time	20 x 10 ⁶
Electrical life time AC1	0.1 x 10 ⁶
Isolation voltage of input/output	2 kV
Connection clamps	Pluggable screw clamp
Wire range fine-stranded/solid	0.2 - 2.5 mm ² (AWG 24 - 14)
Degree of protection / mounting rail	IP 20 / TH 35 (EN60715)
Dimensions (mm) W x H x D	22.5 x 96.5 x 114
Operation temperature range	-25 ... +55 °C
Approvals	CE

flare CONTROL I-1-A

- Multi-function measuring relay
- Upper and lower threshold separately adjustable
- 3 measuring ranges (single phase)
- Signal shape DC and sinus
- Closed circuit or operating circuit principle
- Time delay at exceeding the threshold adjustable
- Wide input voltage range 20,4 ... 264 V AC/DC
- Width 22.5 mm
- Pluggable screw clamps
- Wide temperature range
- 2 change-over contacts 5 A



Type	Part No.
flare CONTROL I-1-A	81.030.0110.0
Technical data	
Measuring ranges	0,1 / 1 / 10 A
Upper threshold	10...100 % of measuring range
Lower threshold	50 ... 95 % of upper threshold
Signal shape	DC and sinus
Nominal frequency of measured signal at AC	45 ... 400 Hz
Nominal power	ca. 2 W / 4 VA
Supply voltage range	20.4 ... 264 V AC/DC
Galvanic isolation toward supply	Yes
Functions	Closed circuit or operating circuit principle
Time delay at exceeding the threshold	0 / 0.1 / 0.,5 / 2 / 10 s
Number of change-over contacts	2 (simultaneously switching)
Maximum switching current	5 A
Mechanical life time	20 x 10 ⁶
Electrical life time AC1	0.1 x 10 ⁶
Isolation voltage of input/output	2 kV
Connection clamps	Pluggable screw clamp
Wire range fine-stranded/solid	0.2 - 2.5 mm ² (AWG 24 - 14)
Degree of protection / mounting rail	IP 20 / TH 35 (EN60715)
Dimensions (mm) W x H x D	22.5 x 96.5 x 114
Operation temperature range	-25 ... +55 °C
Approvals	CE



Monitoring relay

flare CONTROL P3-L

- 3 phase monitoring relay
- Detection for loss of one or more phases
- Detection of wrong phase sequence
- Closed circuit principle
- Width 22.5 mm
- 1 change-over contact 6 A



Type	Part No.
flare CONTROL P3-L	81.030.0020.0
Technical data	
Supply voltage range	200 ... 500 V AC
Detection time	max. 0.1 s
Number of change-over contacts	1
Maximum switching current	6 A
Mechanical life time	10 x 10 ⁶
Electrical life time AC1	0.05 x 10 ⁶
Connection clamps	Screw clamp
Wire range fine-stranded/solid	0.14 - 4 mm ² (AWG 26 - 12)
Degree of protection / Mounting rail	IP 20 / TH 35 (EN60715)
Dimensions (mm) W x H x D	22.5 x 100 x 100
Operation temperature range	-20 ... +60°C
Approvals	CE

flare CONTROL P3-LTN

- 3 phase monitoring relay
- 3 or 4 wire monitoring
- Detection for loss of one or more phases
- Detection of wrong phase sequence
- Adjustable asymmetry trigger 3 wire
- Closed circuit principle
- Supports worldwide mains systems (adjustable)
- Width 22,5 mm
- 1 change-over contact 6 A



Type	Part No.
flare CONTROL P3-LTN	81.030.0021.0
Technical data	
Supply voltage 3 phase / 3 wire	380, 400, 415, 480 V AC
Supply voltage 3 phase / 4 wire	220, 230, 240, 277 V AC
Detection range for asymmetry	2 ... 22 %
Detection time at asymmetry	0.1 ... 30 s
Number of change-over contacts	1
Maximum switching current	6 A
Mechanical life time	10 x 10 ⁶
Electrical life time AC1	0.05 x 10 ⁶
Connection clamps	Screw clamp
Wire range fine-stranded/solid	0.14 - 4 mm ² (AWG 26 - 12)
Degree of protection / Mounting rail	IP 20 / TH 35 (EN60715)
Dimensions (mm) W x H x D	22.5 x 100 x 100
Operation temperature range	-20 ... +60 °C
Approvals	CE





More products which complement your *interface* applications

Contacts are green

Wieland Electric is one of the global technology and innovation leaders in the field of pluggable connections for building system technology and industrial automation. Wherever power and signals are distributed, Wieland's motto is: green light for innovative ideas. Because: contacts are green.

Wieland Electric offers you suitable products for all applications.



Wieland product ranges:

- Safety
- DIN rail terminal blocks
- Industrial plug connectors
- Fieldbus components
- Distributed automation
- Circular connector system
- System plug connectors
- PCB terminals and connectors





safety

wieland

Sichere Systemlösungen für die Automatisierungstechnik
Katalog 2012

Sicherheit geht vor.

Reliable signal detection
sensor PRO

Universal safety relays
safe RELAY

More information is available
in the "Safety first" brochure.

Order No. 0860.1

Safety is a matter of confidence

The demands on facilities, machines and vehicles are high these days. Apart from the productivity and efficiency of a machine or vehicle, the focus is also increasingly on safety. Designing modern means of transportation, facilities and machines also requires consideration of the safety of the persons working with these machines or using these means of transportation.



Reliable and innovative solutions are needed that contribute to meeting this important requirement without affecting the productivity and availability of the facility or means of transportation. With its **sensor** PRO, **safe** RELAY, **samos**® and **samos**® PRO, Wieland Electric offers superior quality safety components which can contribute substantially to safety in production and operation of modern facilities or machines.

Modular safety units
samos®



Compact safety control **samos**® PRO



fasis* & *selos

Innovative DIN rail terminal blocks

DIN rail terminal blocks are the standard connection component in all areas of electrical engineering. Whether in machinery or power supply applications, DIN rail terminal blocks are used for signal and power distribution as well as for the conventional electrical installation of buildings.

Due to their high mechanical strength and contact stability the DIN rail terminal blocks from Wieland are particularly suitable for our customers' requirements.

Wieland Electric DIN rail terminal block product lines from Wieland Electric for worldwide use:

- ***fasis*** – DIN rail terminal blocks with spring clamp and push-in connection
- ***selos*** – DIN rail terminal blocks with screw connection

Whether explosion and fire protection, vibration and shock resistance or international approvals for worldwide use – Wieland Electric provides solutions in different connection techniques.



Please find further Information
in our catalog DIN Rail terminal blocks
Order no: 0500.1



Application

Wieland Electric supplies superior quality products for user specific applications.

fasis and selos rail terminal block system features:

- Reliable functionality
- Efficient applications
- Customized to your needs



Functionality and system

Terminal blocks are electrical wire connection systems and can be found wherever electrical energy is generated, transferred and distributed.

System components for measuring and control tasks are, e.g.:

- Isolating terminals
- Fuse blocks
- Function blocks



Planning and configuration

wieplan was developed to provide you with a powerful software tool for configuring terminal block assemblies using Wieland rail terminal blocks.

- Configuring terminal block assemblies
- Data exchange with CAE systems
- Ordering terminal block assemblies
- Issuing drawing and parts lists



Pre-assembly and installation

For customers who want to save time and work on the control cabinet, Wieland Electric offers pre-assembled, fully equipped terminal blocks – even with connected conductors, if desired.

- Marking system of all applications in the switch board cabinet
- Hand held tools for terminal blocks and accessories
- Software tools





For any application – Heavy-duty industrial connectors

The **revos** heavy-duty industrial connectors are categorized according to their housings, contact inserts and connection technology. A wide range standard program, as well as modular components that can be combined, per customer specific requirements, are available.

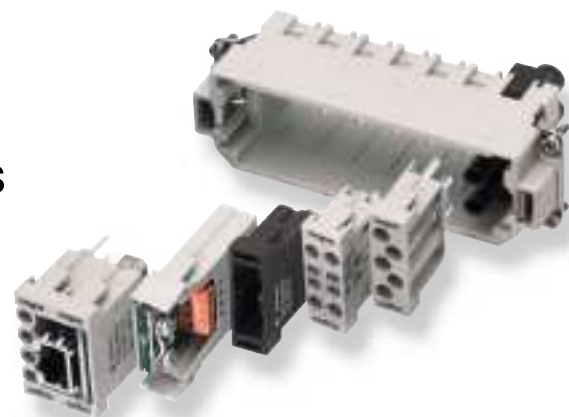

- **revos** BASIC with 6 to 92-pole contact inserts
- **revos** POWER high-current pluggable connector for currents up to 100 A
- **revos** HD high density multipole pluggable connector with up to 64 poles and up to 10 A
- **revos** FLEX modular hybrid pluggable connector system to equip your connector, as needed, with mixed contact inserts, including signal, pneumatics and fiber optic cable components
- **revos** BASIC EMV for applications where electromagnetic interferences must be shielded from entering or exiting the connector.



revos BASIC



The conventional industrial connector. The die-cast aluminum housing with powder-coated surface provides reliable protection. The contact inserts come in 6-92-pole design. **revos** BASIC meets the highest demands and is used in the automotive industry, mechanical and system engineering, conveyor systems, and process measuring and control technology.

revos POWER

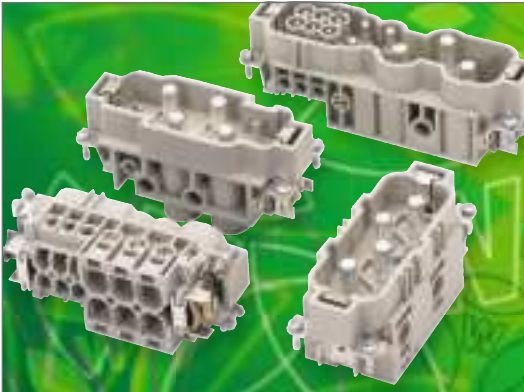

The Wieland Electric high current pluggable connector. Contact inserts and multipole adapters accommodate currents exceeding 16 A and are also available with a mix of contact amperages with screw connection. Contact inserts and adaptors are protected inside the **revos** BASIC housings. **revos** POWER applications include mechanical and system engineering for small drives, motors, pumps and frequency converters.

revos HD



revos HD is designed specifically for multi-pole pluggable connectors. The robust housings provide space for contact inserts with 15 to 64 poles and are designed for currents up to 10 A (in compliance with DIN EN 17 5301-801). **revos** HD proves its strengths in mechanical and system engineering, in escalators, small motors and injection molding machines.

revos DD

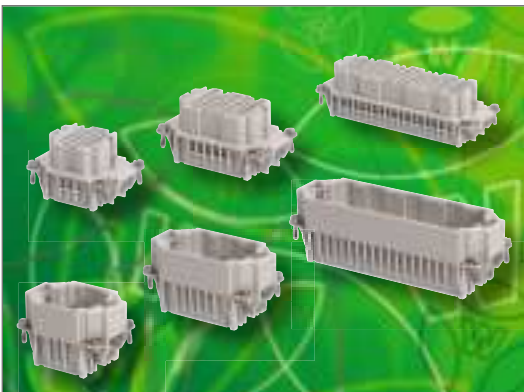

High contact density in a very limited space – this is what **revos** DD space-saving contact inserts offer. The inserts are compatible with BASIC housing sizes 6/6H-, 10/10H-, 16/16H-, and 24/24H. They are connected with reliable, turned 1.6 mm crimp contacts and a termination range of 0.14 – 2.5 mm² at a rated voltage of 250 V.

revos FLEX

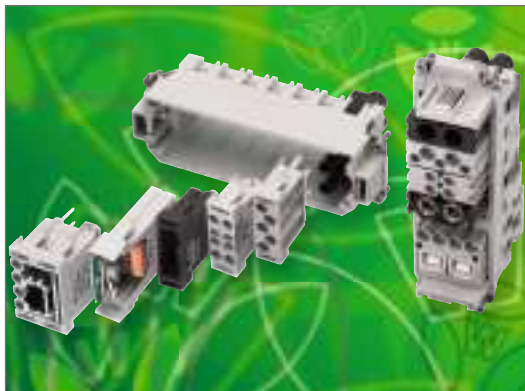

Do you want a customized industrial pluggable connector for your specific application? No problem, thanks to **revos FLEX**. With this modular and flexible system, you are free to configure and assemble your pluggable connector according to your needs. The smart solution for any tasks in mechanical and system engineering, in process measuring and control technology and the automotive industry.

revos MINI



Small but robust. Thanks to its extremely compact contact inserts with 3 to 12 poles, **revos MINI** can be integrated in applications for mechanical, control systems and control engineering, small motors and lighting engineering. Its zinc die-cast or polyamide pluggable connector housing helps **revos MINI** to withstand rough environments.

revos



In explosion hazardous areas such as mining or the chemical industry, electrical components need to meet specific requirements. The **revos**® series provides heavy-duty pluggable connectors especially designed for systems where explosion protection is absolutely essential. The BVS (Association of Publicly Certified and Qualified Experts) testing institute approved the use of **revos**® in zone 1 for intrinsically safe circuits.

revos IT



In some applications, the data cable feed-through must be protected by a heavy-duty pluggable connector. **revos IT** is the ideal solution. These connectors facilitate the feeding of pre-assembled cables into a closed, sealed housing with strain relief. D-sub plug-in connections are available with 4 to 100 poles. **revos IT** protects data transmission to PLCs or to measuring and encoder lines.





podis® & gesis® Systems with unique advantages

podis® – uninterrupted flat cable

Application

- in conveyor systems
- in linear-designed facilities
- in expandable systems
- in modular-designed systems

Advantages podis® – uncut flat cable

- No cutting, no stripping
- Quick and easy connection
- Secure terminations
- Just a few components for the entire system
- Easy-to-add drops wherever needed



gesis® – plug-in round cable

Application

- In conveyor facilities
- For modular-design facilities
- For star or network structures
- Where complex cable routing is an issue

Advantages gesis® – plug-in round cable

- Plug in and go
- Ideal for modular systems
- Easy creation of network structures
- Just a few components for entire system
- Can be expanded as required



Software TOOLS

Wieland Software perfects your applications

Wieland Electric offers specially designed software for its individual products, making them exceptionally easy to use and making configuration and product selection easy.



revos configurator

This software tool facilitates the selection of heavy-duty connectors.

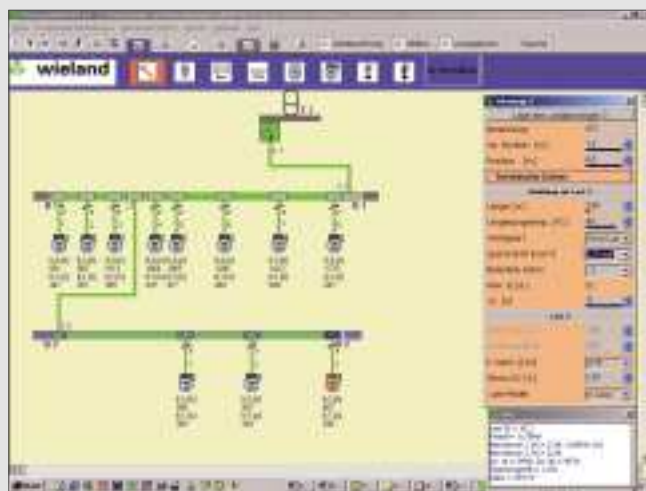

podis PLAN

podis PLAN, allows you to design your distributed power bus perfectly and test important electrotechnical parameters.

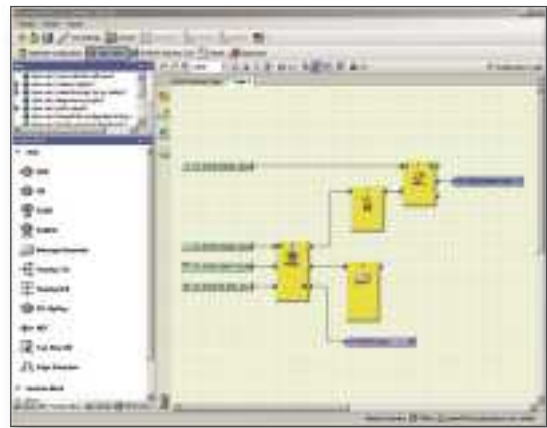

samos PLAN

This programming tool for samos PRO supports designers and machine manufacturers in the programming, diagnosis, and documentation of all the safety functions of a machine.

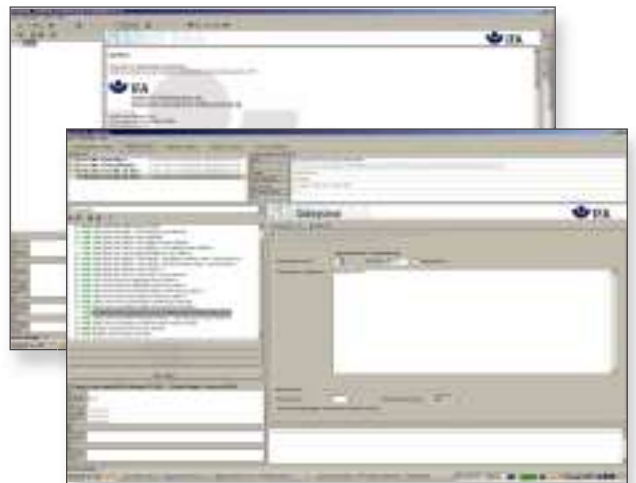

SISTEMA library

The SISTEMA library contains all safety components from Wieland Electric and, in combination with the SISTEMA software tool provided by the IFA (Institute for Occupational Safety and Health of the German Social Accident Insurance), allows the safety-related parameters of a machine's functions to be calculated according to EN ISO 13849-1.



wieplan wiemarc

DIN rail terminal blocks: Planning and labeling with a system



Hotline – one call is all it takes

Our Technical Service Department is ready to answer all your questions on the subject of interface.

Please call our hotline **+49 951 9324-995**.



Wieland e-Catalog

For further technical information and the latest news on interface technology, go to:

<http://eshop.wieland-electric.com>



Hotline • advice

Additional information

Technical support

Automation technology:

Phone: +49 951 9324- . . .

- Safety technology **safety** -999
e-mail: safety@wieland-electric.com
- **interface:** -995
Power supply, industrial Ethernet switches, timer relays, measuring and monitoring relays, coupling relays, analog modules, remote I/O, surge protection, passive interfaces, remote power distribution **podis**®
- DIN rail terminal blocks **fasis, selos** -991
Industrial multipole connectors **revos**
PCB terminals and connectors **wiecon**, appliance terminals, european terminal strips, housings for electronic components

Fax: +49 951 9326-991
e-mail: AT.TS@wieland-electric.com

Technical Support

Building services engineering:

Phone: +49 951 9324- . . .

- System connectors for building installation -996
gesis CON, **gesis** RAN, **gesis** ELECTRONIC
 - DIN rail terminal blocks **fasis** BIT, **selos** BIT -991
- Fax: +49 951 9326-996
e-mail: BIT.TS@wieland-electric.com

Technical Support

Photovoltaics/solar technology:

Phone: +49 951 9324- . . .

- Photovoltaics **gesis** SOLAR -972
- Fax: +49 951 9326-977
e-mail: Solar@wieland-electric.com

Sales service:

- To contact our sales department regarding availability, delivery schedules, and pricing please call

Phone: +49 951 9324-990

General information and news:
www.wieland-electric.com

Visit our eCAT at
<http://eshop.wieland-electric.com>



Our subsidiaries

... and the addresses of our representatives worldwide are available at:

www.wieland-electric.com



USA

Wieland Electric Inc.
49 International Road
Burgaw, N.C. 28425
Phone +1-910-259 5050
Fax +1-910-259 3691
www.wielandinc.com



CANADA

Wieland Electric Inc.
2889 Brighton Road
Oakville, Ontario L6H 6C9
Phone +1-905-829 8414
Fax +1-905-829 8413
www.wieland-electric.ca



GREAT BRITAIN

Wieland Electric Ltd.
Riverside Business Centre,
Walnut Tree Close
GB-Guildford/Surrey GU1 4UG
Phone +44-1483-531 213
Fax +44-1483-505 029
sales@wieland.co.uk



FRANCE

Wieland Electric SARL.
Le Céramê Hall 6
47, avenue des Genottes
CS 48313
95803 Cergy-Pontoise Cedex
Phone +33-1-30 32 07 07
Fax +33-1-30 32 07 14
infos@wieland-electric.fr



SPAIN

Wieland Electric S.L.
C/ Maria Auxiliadora 2 bajos
E-08017 Barcelona
Phone +34-93-252 3820
Fax +34-93-252 3825
ventas@wieland-electric.com



ITALY

Wieland Electric S.r.l.
Via Edison, 209
I-20019 Settimo Milanese
Phone +39-02-48 91 63 57
Fax +39-02-48 92 06 85
info@wieland-electric.it



POLAND

Wieland Electric Sp. Zo.o.
Św. Antoniego 8
62-080 Swadzim
Phone +48-61-2 22 54 00
Fax +48-61-8 40 71 66
office@wieland-electric.pl



CHINA

Wieland Electric Trading
Unit 2703
International Soho City
889 Renmin Rd., Huang Pu District
PRC- Shanghai 200010
Phone +86-21-63 555 833
Fax +86-21-63 550 090
info-shanghai@wieland-electric.cn



CZECH REPUBLIC

(Production)
Wieland Electric s.r.o.
Nadražni 1557
356 01 Sokolov
Phone +420-352 302 011
Fax +420-352 302 027



DENMARK

Wieland Electric A/S
Vallørækken 26
DK-4600 Køge
Phone +45-70-26 66 35
Fax +45-70-26 66 37
sales@wieland-electric.dk



◀ **Informational material for ordering and for downloading from our websites**

Subject to technical modifications!

gesis®, **podis**®, **samos**® are registered trademarks of Wieland Electric GmbH



wieland

Headquarters:

Wieland Electric GmbH
Brennerstraße 10 – 14
96052 Bamberg, Germany

Sales and Marketing Center:

Wieland Electric GmbH
Benzstraße 9
96052 Bamberg, Germany

Phone +49 951 9324-0

Fax +49 951 9324-198

www.wieland-electric.com

www.gesis.com

info@wieland-electric.com

Industrial technology

Solutions for the control cabinet

- DIN rail terminal blocks
 - Screw, tension spring or push-in connection technology
 - Wire cross sections up to 240 mm²
 - Numerous special functions
 - Software solutions interfacing to CAE systems
- Safety
 - Safe signal acquisition
 - Safety switching devices
 - Modular safety modules
 - Compact safety controllers
 - Applicative consultancy and training
- Network engineering and fieldbus systems
 - Remote maintenance via VPN industrial router and VPN service portal
 - Industrial Ethernet switches
 - PLC and I/O systems, standard and increased environmental conditions
- Interface
 - Power supply units
 - Overvoltage protection
 - Coupling relays, semiconductor switches
 - Timer relays, measuring and monitoring relays
 - Analog coupling and converter modules
 - Passive interfaces

Solutions for field applications

- Decentralized installation and automation technology
 - Electrical installation for wind tower
 - Fieldbus interfaces and motor starters
- Connectors for industrial applications
 - Rectangular and round connectors
 - Aluminum or plastic housings
 - Degree of protection up to IP68
 - Current-carrying capacity up to 100 A
 - Connectors for hazardous areas
 - Modular, application-specific technology

PC board terminals and connectors

- Screw or spring clamp connection technology
- Spacings: 3.5 mm to 10.16 mm
- Reflow or wave soldering process

Building and installation technology

- Building installation systems
 - Main power supply connectors IP 20/IP 65... IP 68
 - Bus connectors
 - Low-voltage connectors
 - Power distribution system with flat cables
 - Distribution systems
 - Bus systems in KNX, LON and radio technology
 - DIN rail terminal blocks for electrical installations
 - Overvoltage protection

contacts
are
green.