

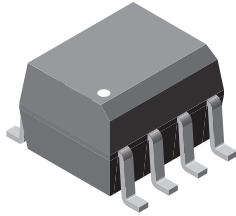

Optocoupler, Phototransistor Output, Dual Channel, SOIC-8 Package

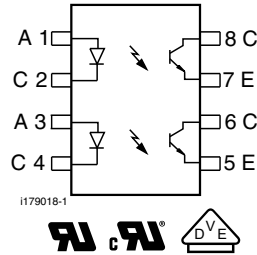

i179074



FEATURES

- Two channel coupler
- SOIC-8 surface mountable package
- Standard lead spacing of 0.05"
- Available only on tape and reel option (conforms to EIA standard 481-2)
- Isolation test voltage, 4000 V_{RMS}
- Compatible with dual wave, vapor phase and IR reflow soldering
- Material categorization: For definitions of compliance please see www.vishay.com/doc?99912



RoHS COMPLIANT

DESCRIPTION

The VOD205T, VOD206T, VOD207T, VOD211T, VOD213T, VOD217T are optically coupled pairs with a gallium arsenide infrared LED and a silicon NPN phototransistor. Signal information, including a DC level, can be transmitted by the device while maintaining a high degree of electrical isolation between input and output.

AGENCY APPROVALS

- UL1577, file no. E52744 system code Y
- cUL - file no. E52744, equivalent to CSA bulletin 5A
- DIN EN 60747-5-5 (VDE 0884-5) approved, contact customer service if this option is required

ORDERING INFORMATION

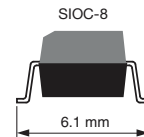
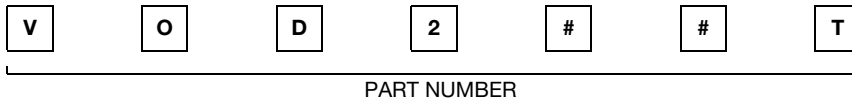

AGENCY CERTIFIED/PACKAGE	CTR (%)					
UL, cUL	40 to 80	63 to 125	100 to 200	> 20	> 100 ⁽¹⁾	> 100 ⁽²⁾
SOIC-8	VOD205T	VOD206T	VOD207T	VOD211T	VOD213T	VOD217T

Notes

- (1) I_F = 10 mA
 (2) I_F = 1 mA

ABSOLUTE MAXIMUM RATINGS (T_{amb} = 25 °C, unless otherwise specified)

PARAMETER	TEST CONDITION	SYMBOL	VALUE	UNIT
INPUT				
Peak reverse voltage		V _R	6	V
Peak pulsed current	1 μs, 300 pps	I _{FM}	1	A
Continuous forward current per channel		I _F	30	mA
Power dissipation		P _{diss}	50	mW
Derate linearly from 25 °C			0.66	mW/°C
OUTPUT				
Collector emitter breakdown voltage		BV _{CEO}	70	V
Emitter collector breakdown voltage		BV _{ECO}	7	V
Continuous output current		I _{Cmax}	50	mA
Power dissipation per channel		P _{diss}	125	mW
Derate linearly from 25 °C			1.67	mW/°C



ABSOLUTE MAXIMUM RATINGS ($T_{amb} = 25\text{ }^{\circ}\text{C}$, unless otherwise specified)				
PARAMETER	TEST CONDITION	SYMBOL	VALUE	UNIT
COUPLER				
Isolation test voltage	$t = 1\text{ s}$	V_{ISO}	4000	V_{RMS}
Total package dissipation ambient (2 LEDs and 2 detectors, 2 channels)		P_{tot}	300	mW
Derate linearly from 25 °C			4	mW/°C
Storage temperature		T_{stg}	-40 to +150	°C
Operating temperature		T_{amb}	-40 to +100	°C
Soldering time from 260 °C ⁽¹⁾		T_{sld}	10	s

Notes

- Stresses in excess of the absolute maximum ratings can cause permanent damage to the device. Functional operation of the device is not implied at these or any other conditions in excess of those given in the operational sections of this document. Exposure to absolute maximum ratings for extended periods of the time can adversely affect reliability.
- ⁽¹⁾ Refer to reflow profile for soldering conditions for surface mounted devices.

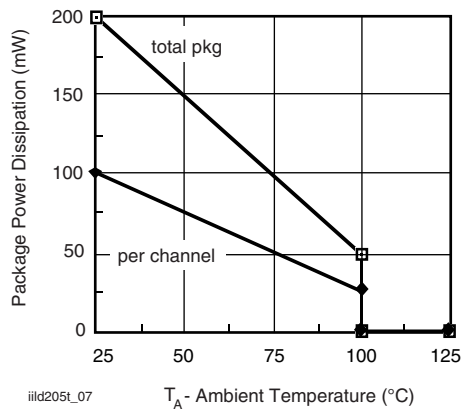

Fig. 1 - Power Dissipation vs. Ambient Temperature

ELECTRICAL CHARACTERISTICS ($T_{amb} = 25\text{ }^{\circ}\text{C}$, unless otherwise specified)							
PARAMETER	TEST CONDITION	PART	SYMBOL	MIN.	TYP.	MAX.	UNIT
INPUT							
Forward voltage	$I_F = 10\text{ mA}$		V_F		1.2	1.55	V
Reverse current	$V_R = 6\text{ V}$		I_R		0.1	100	μA
Capacitance	$V_R = 0\text{ V}$		C_O		25		pF
OUTPUT							
Collector emitter breakdown voltage	$I_C = 100\text{ }\mu\text{A}$		BV_{CEO}	70			V
Emitter collector breakdown voltage	$I_E = 100\text{ }\mu\text{A}$		BV_{ECO}	7			V
Collector emitter leakage current	$V_{CE} = 10\text{ V}, I_F = 0\text{ A}$		I_{CEO}		5	50	nA
Collector emitter capacitance	$V_{CE} = 0\text{ V}$		C_{CE}		10		pF
Collector emitter saturation voltage	$I_F = 10\text{ mA}, I_C = 2.5\text{ mA}$		V_{CEsat}			0.4	V
COUPLER							
Capacitance (input to output)			C_{IO}		0.5		pF

Note

- Minimum and maximum values were tested requirements. Typical values are characteristics of the device and are the result of engineering evaluations. Typical values are for information only and are not part of the testing requirements.



CURRENT TRANSFER RATIO							
PARAMETER	TEST CONDITION	PART	SYMBOL	MIN.	TYP.	MAX.	UNIT
I_C/I_F	$V_{CE} = 5\text{ V}, I_F = 10\text{ mA}$	VOD205T	CTR_{DC}	40		80	%
		VOD206T	CTR_{DC}	63		125	%
		VOD207T	CTR_{DC}	100		200	%
		VOD211T	CTR_{DC}	20			%
		VOD213T	CTR_{DC}	100			%
	$V_{CE} = 5\text{ V}, I_F = 1\text{ mA}$	VOD205T	CTR_{DC}	13	30		%
		VOD206T	CTR_{DC}	22	45		%
		VOD207T	CTR_{DC}	34	70		%
VOD217T	CTR_{DC}	100	120		%		

SWITCHING CHARACTERISTICS							
PARAMETER	TEST CONDITION	SYMBOL	MIN.	TYP.	MAX.	UNIT	
Turn-on time	$I_C = 2\text{ mA}, R_L = 100\ \Omega, V_{CC} = 5\text{ V}$	t_{on}		5		μs	
Turn-off time	$I_C = 2\text{ mA}, R_L = 100\ \Omega, V_{CC} = 5\text{ V}$	t_{off}		4		μs	
Rise time	$I_C = 2\text{ mA}, R_L = 100\ \Omega, V_{CC} = 5\text{ V}$	t_r		5		μs	
Fall time	$I_C = 2\text{ mA}, R_L = 100\ \Omega, V_{CC} = 5\text{ V}$	t_f		4		μs	

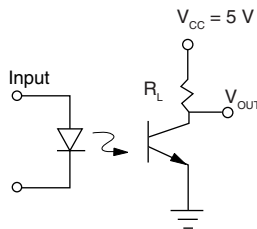

iii215at_17

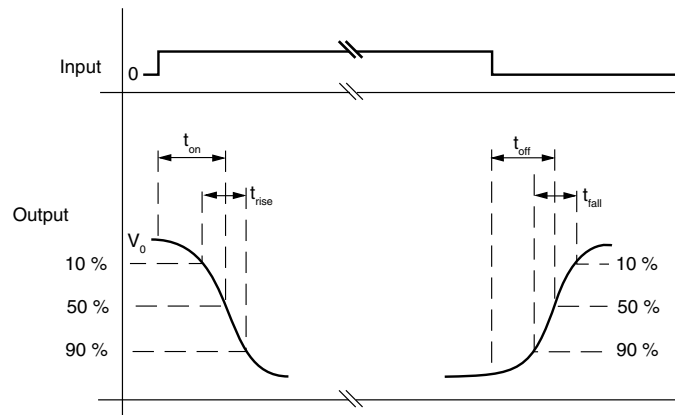

Fig. 2 - Switching Test Circuit

COMMON MODE TRANSIENT IMMUNITY							
PARAMETER	TEST CONDITION	SYMBOL	MIN.	TYP.	MAX.	UNIT	
Common mode transient immunity at logic high	$V_{CM} = 1000\text{ V}_{P-P}, R_L = 1\text{ k}\Omega, I_F = 0\text{ mA}$	$ C_{MH} $		10 000		$\text{V}/\mu\text{s}$	
Common mode transient immunity at logic low	$V_{CM} = 1000\text{ V}_{P-P}, R_L = 1\text{ k}\Omega, I_F = 10\text{ mA}$	$ C_{ML} $		10 000		$\text{V}/\mu\text{s}$	

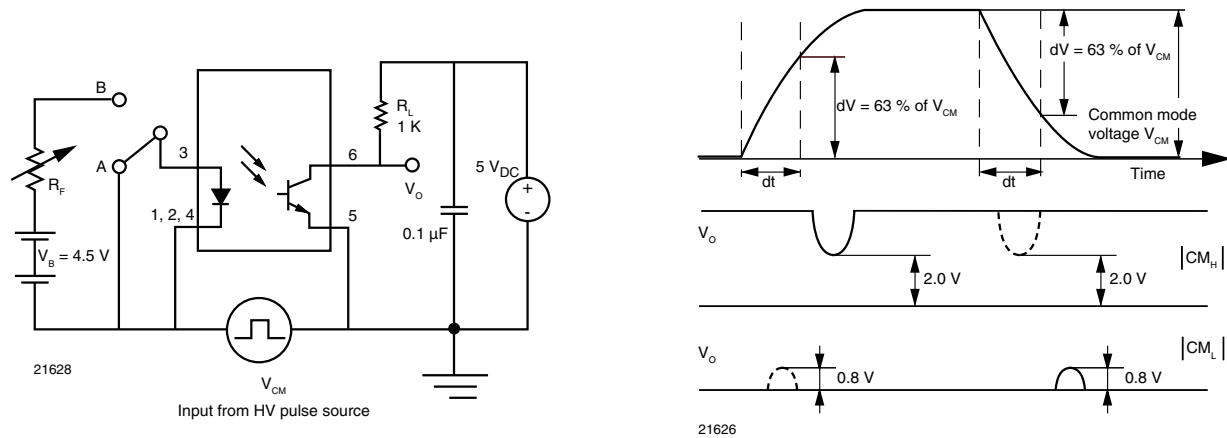

Fig. 3 - Test Circuit for Common Mode Transient Immunity

SAFETY AND INSULATION RATINGS						
PARAMETER	TEST CONDITION	SYMBOL	MIN.	TYP.	MAX.	UNIT
Climatic classification	according to IEC 68 part 1			40/100/21		
Polution degree				2		
Comparative tracking index		CTI	175		399	
Peak transient overvoltage		V_{IOTM}	6000			V
Peak insulation voltage		V_{IORM}	560			V
Resistance (input to output)		R_{IO}		100		GΩ
Apparent charge method a		q_{pd}				C
Apparent charge method b		q_{pd}				C
Safety rating - power output		P_{SO}			350	mW
Safety rating - input current		I_{SI}			150	mA
Safety rating - temperature		T_{SI}			165	°C
External creepage distance			4			mm
Internal creepage distance			4			mm
External clearance distance			4			mm
Insulation thickness			0.2			mm

Note

- As per IEC 60747-5-5, §7.4.3.8.2, this optocoupler is suitable for “safe electrical insulation” only within the safety ratings. Compliance with the safety ratings shall be ensured by means of protective circuits.



TYPICAL CHARACTERISTICS ($T_{amb} = 25\text{ }^{\circ}\text{C}$, unless otherwise specified)

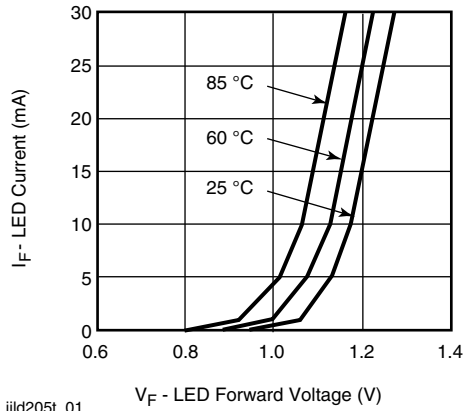

iiid205t_01

Fig. 4 - Forward Current vs. Forward Voltage

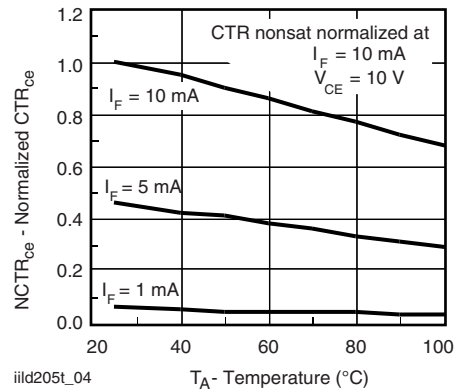

iiid205t_04

Fig. 7 - Current Transfer Ratio (normalized) vs. Ambient Temperature

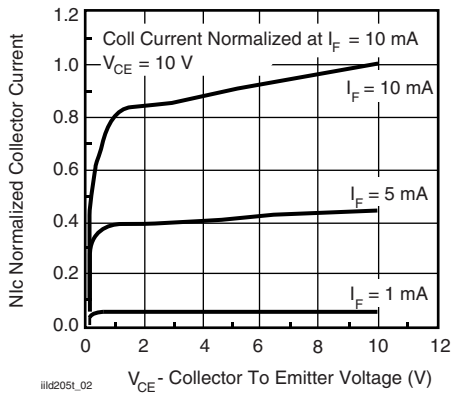

iiid205t_02

Fig. 5 - Collector Emitter Current vs. V_{CE}

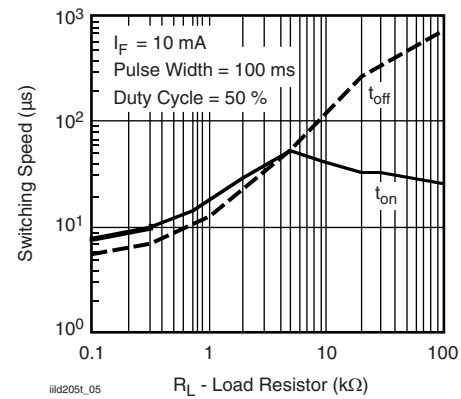

iiid205t_05

Fig. 8 - Switching Speed vs. Load Resistor

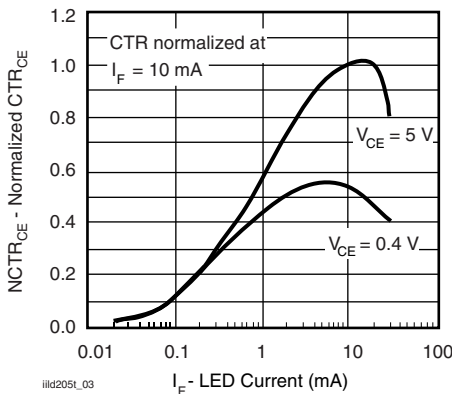

iiid205t_03

Fig. 6 - Normalized CTR_{CE} vs. Forward Current

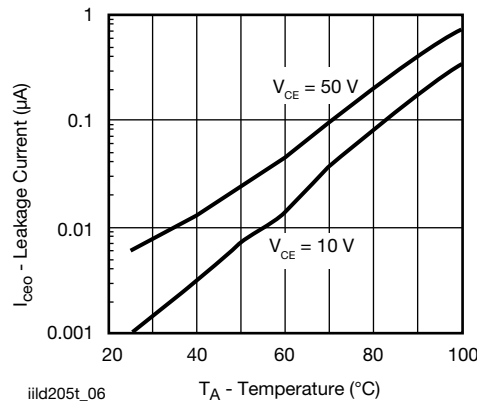

iiid205t_06

Fig. 9 - Collector Current vs. Ambient Temperature



PACKAGE DIMENSIONS in millimeters

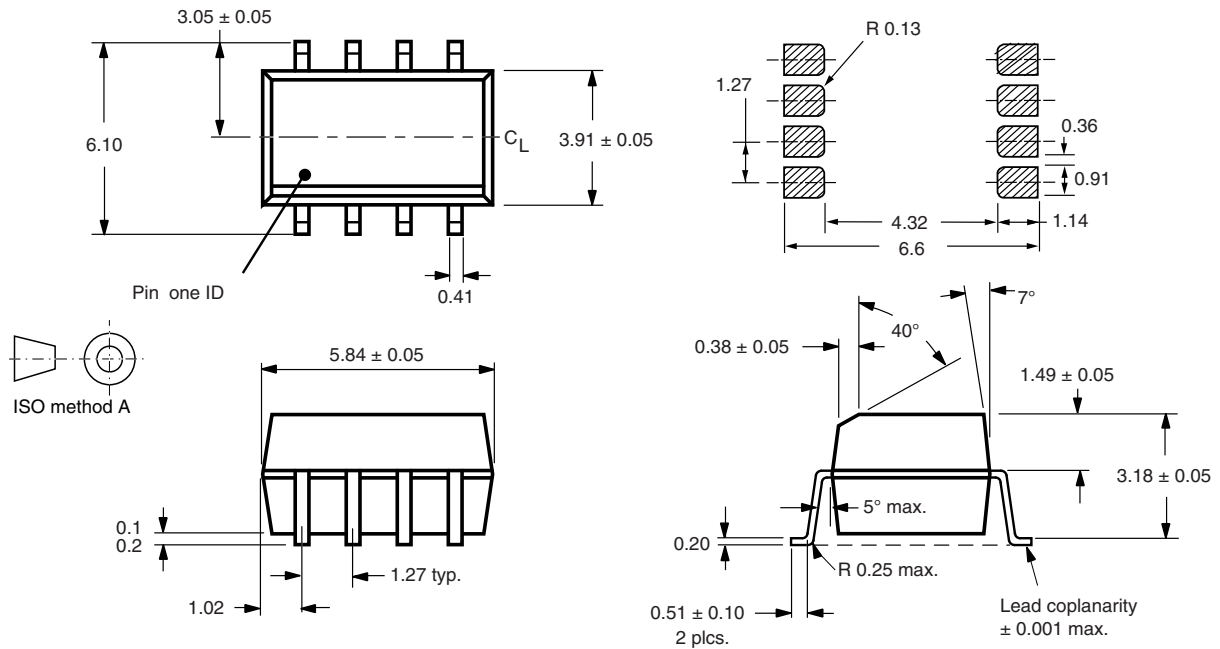

i178020

PACKAGE MARKING (example of VOD207T)

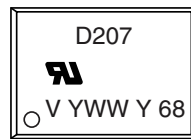

TAPE AND REEL PACKAGING

Dimensions in millimeters

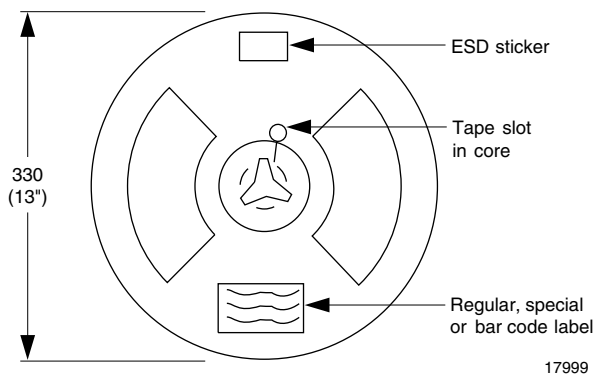

Fig. 10 - Tape and Reel Shipping Medium (EIA-481, revision A, and IEC 60286), 2000 units per reel

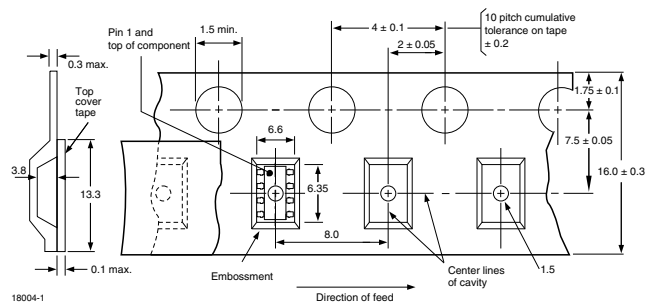

Fig. 11 - Tape Dimensions, 2000 Parts per Reel



Disclaimer

ALL PRODUCT, PRODUCT SPECIFICATIONS AND DATA ARE SUBJECT TO CHANGE WITHOUT NOTICE TO IMPROVE RELIABILITY, FUNCTION OR DESIGN OR OTHERWISE.

Vishay Intertechnology, Inc., its affiliates, agents, and employees, and all persons acting on its or their behalf (collectively, "Vishay"), disclaim any and all liability for any errors, inaccuracies or incompleteness contained in any datasheet or in any other disclosure relating to any product.

Vishay makes no warranty, representation or guarantee regarding the suitability of the products for any particular purpose or the continuing production of any product. To the maximum extent permitted by applicable law, Vishay disclaims (i) any and all liability arising out of the application or use of any product, (ii) any and all liability, including without limitation special, consequential or incidental damages, and (iii) any and all implied warranties, including warranties of fitness for particular purpose, non-infringement and merchantability.

Statements regarding the suitability of products for certain types of applications are based on Vishay's knowledge of typical requirements that are often placed on Vishay products in generic applications. Such statements are not binding statements about the suitability of products for a particular application. It is the customer's responsibility to validate that a particular product with the properties described in the product specification is suitable for use in a particular application. Parameters provided in datasheets and/or specifications may vary in different applications and performance may vary over time. All operating parameters, including typical parameters, must be validated for each customer application by the customer's technical experts. Product specifications do not expand or otherwise modify Vishay's terms and conditions of purchase, including but not limited to the warranty expressed therein.

Except as expressly indicated in writing, Vishay products are not designed for use in medical, life-saving, or life-sustaining applications or for any other application in which the failure of the Vishay product could result in personal injury or death. Customers using or selling Vishay products not expressly indicated for use in such applications do so at their own risk. Please contact authorized Vishay personnel to obtain written terms and conditions regarding products designed for such applications.

No license, express or implied, by estoppel or otherwise, to any intellectual property rights is granted by this document or by any conduct of Vishay. Product names and markings noted herein may be trademarks of their respective owners.

Material Category Policy

Vishay Intertechnology, Inc. hereby certifies that all its products that are identified as RoHS-Compliant fulfill the definitions and restrictions defined under Directive 2011/65/EU of The European Parliament and of the Council of June 8, 2011 on the restriction of the use of certain hazardous substances in electrical and electronic equipment (EEE) - recast, unless otherwise specified as non-compliant.

Please note that some Vishay documentation may still make reference to RoHS Directive 2002/95/EC. We confirm that all the products identified as being compliant to Directive 2002/95/EC conform to Directive 2011/65/EU.

Vishay Intertechnology, Inc. hereby certifies that all its products that are identified as Halogen-Free follow Halogen-Free requirements as per JEDEC JS709A standards. Please note that some Vishay documentation may still make reference to the IEC 61249-2-21 definition. We confirm that all the products identified as being compliant to IEC 61249-2-21 conform to JEDEC JS709A standards.