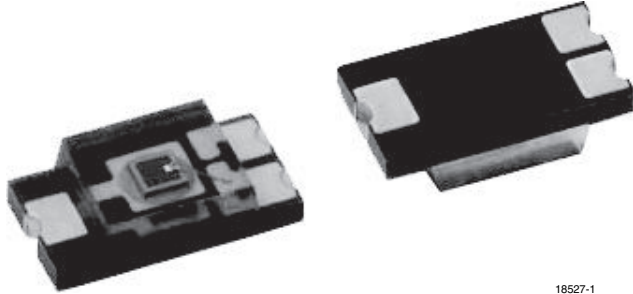


Ambient Light Sensor



18527-1

DESCRIPTION

TEMD6010FX01 ambient light sensor is a PIN photodiode with high speed and high photo sensitivity in a clear, surface mount plastic package. The detector chip has 0.27 mm² sensitive area. It is sensitive to visible light much like the human eye and has peak sensitivity at 540 nm.

FEATURES

- Package type: surface mount
- Package form: 1206
- Dimensions (L x W x H in mm): 4 x 2 x 1.05
- Radiant sensitive area (in mm²): 0.27
- AEC-Q101 qualified
- High photo sensitivity
- Adapted to human eye responsivity
- Supression filter for near infrared radiation
- Angle of half sensitivity: $\phi = \pm 60^\circ$
- Floor life: 168 h, MSL 3, acc. J-STD-020
- Lead (Pb)-free reflow soldering
- Material categorization: For definitions of compliance please see www.vishay.com/doc?99912

 AUTOMOTIVE
GRADE

RoHS
COMPLIANT
GREEN
(5-2009)

APPLICATIONS

- Automotive sensors
- Ambient light sensors
- Backlight dimming
- Mobil phones
- Notebooks
- Computers

PRODUCT SUMMARY

COMPONENT	I_{ra} (μ A)	ϕ (deg)	$\lambda_{0.5}$ (nm)
TEMD6010FX01	0.04	± 60	430 to 610

Note

- Test conditions see table "Basic Characteristics"

ORDERING INFORMATION

ORDERING CODE	PACKAGING	REMARKS	PACKAGE FORM
TEMD6010FX01	Tape and reel	MOQ: 3000 pcs, 3000 pcs/reel	1206

Note

- MOQ: minimum order quantity

ABSOLUTE MAXIMUM RATINGS ($T_{amb} = 25^\circ\text{C}$, unless otherwise specified)

PARAMETER	TEST CONDITION	SYMBOL	VALUE	UNIT
Reverse voltage		V_R	16	V
Power dissipation		P_V	100	mW
Junction temperature		T_j	100	$^\circ\text{C}$
Operating temperature range		T_{amb}	- 40 to + 100	$^\circ\text{C}$
Storage temperature range		T_{stg}	- 40 to + 100	$^\circ\text{C}$
Soldering temperature	Acc. reflow solder profile fig. 7	T_{sd}	260	$^\circ\text{C}$
Thermal resistance junction/ambient	Soldered on PCB with pad dimensions: 4 mm x 4 mm	R_{thJA}	450	K/W

BASIC CHARACTERISTICS ($T_{amb} = 25\text{ }^{\circ}\text{C}$, unless otherwise specified)						
PARAMETER	TEST CONDITION	SYMBOL	MIN.	TYP.	MAX.	UNIT
Breakdown voltage	$I_R = 100\text{ }\mu\text{A}$, $E = 0\text{ lx}$	$V_{(BR)}$	16			V
Reverse dark current	$V_{CE} = 10\text{ V}$, $E = 0\text{ lx}$	I_{ro}		0.1	5	nA
Diode capacitance	$V_R = 0\text{ V}$, $f = 1\text{ MHz}$, $E = 0\text{ lx}$	C_D		60		pF
	$V_R = 5\text{ V}$, $f = 1\text{ MHz}$, $E = 0\text{ lx}$	C_D		24		pF
Reverse light current	$E_e = 1\text{ mW/cm}^2$, $\lambda = 550\text{ nm}$, $V_R = 5\text{ V}$	I_{ra}		1		μA
	$E_V = 100\text{ lx}$, CIE illuminant A, $V_R = 5\text{ V}$	I_{ra}	0.03	0.04	0.09	μA
Temperature coefficient of I_{ra}	$E_V = 100\text{ lx}$, CIE illuminant A, $V_R = 5\text{ V}$	$TK_{I_{ra}}$		0.2		%/K
Angle of half sensitivity		φ		± 60		deg
Wavelength of peak sensitivity		λ_p		540		nm
Range of spectral bandwidth		$\lambda_{0.5}$		430 to 610		nm

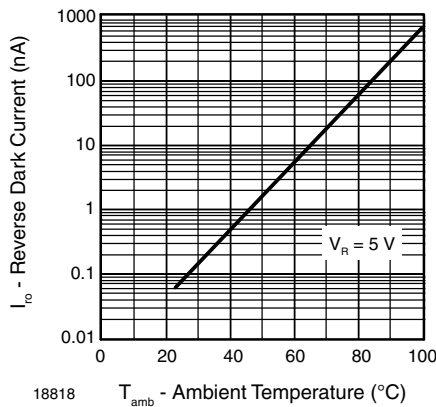
BASIC CHARACTERISTICS ($T_{amb} = 25\text{ }^{\circ}\text{C}$, unless otherwise specified)


Fig. 1 - Reverse Dark Current vs. Ambient Temperature

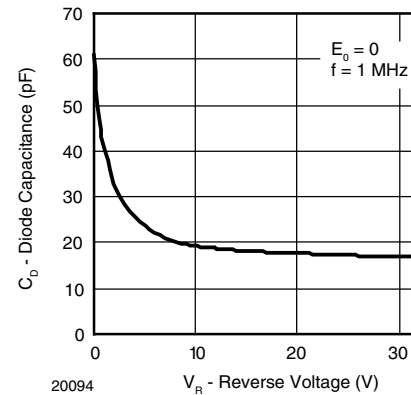


Fig. 3 - Diode Capacitance vs. Reverse Voltage

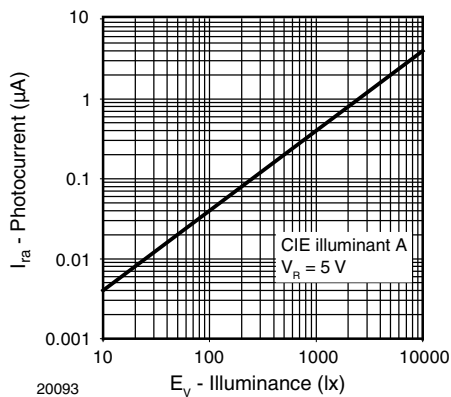


Fig. 2 - Reverse Light Current vs. Illuminance

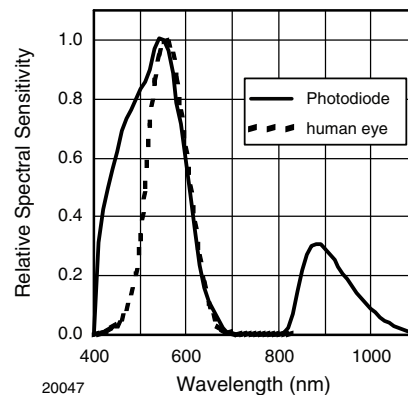


Fig. 4 - Relative Spectral Sensitivity vs. Wavelength

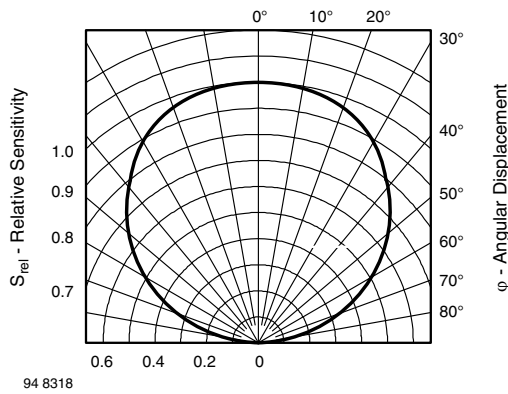


Fig. 1 - Relative Radiant Sensitivity vs. Angular Displacement

REFLOW SOLDER PROFILE

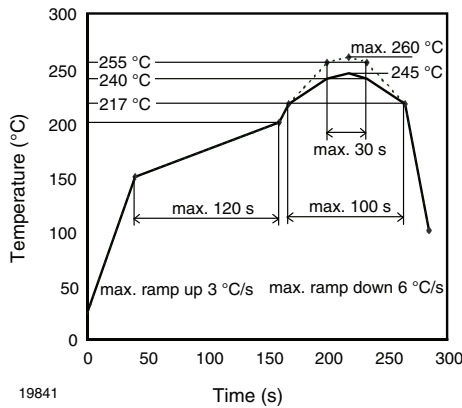
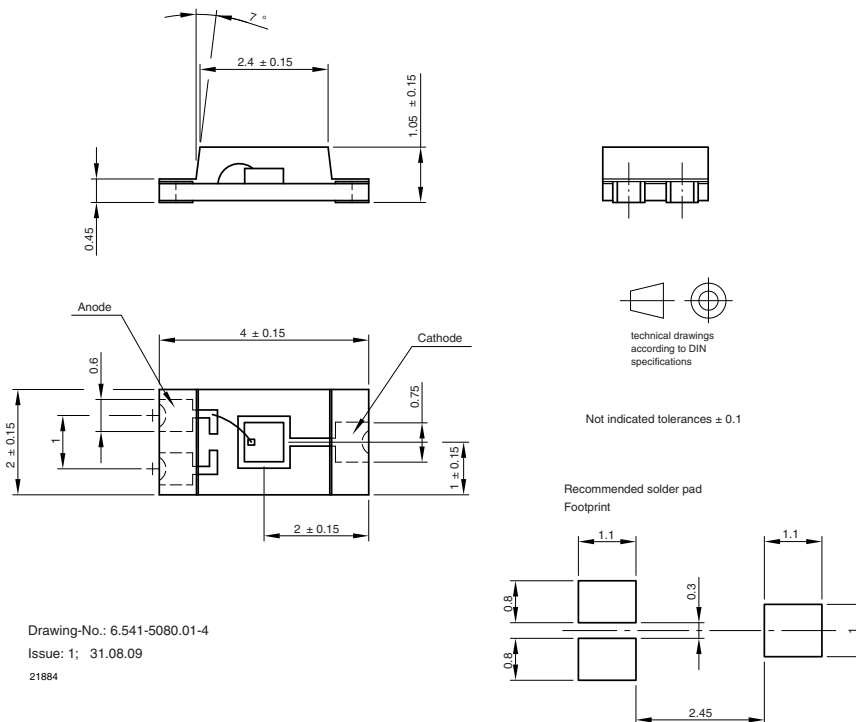


Fig. 5 - Lead (Pb)-free Reflow Solder Profile acc. J-STD-020D

PACKAGE DIMENSIONS in millimeters



DRYPACK

Devices are packed in moisture barrier bags (MBB) to prevent the products from moisture absorption during transportation and storage. Each bag contains a desiccant.

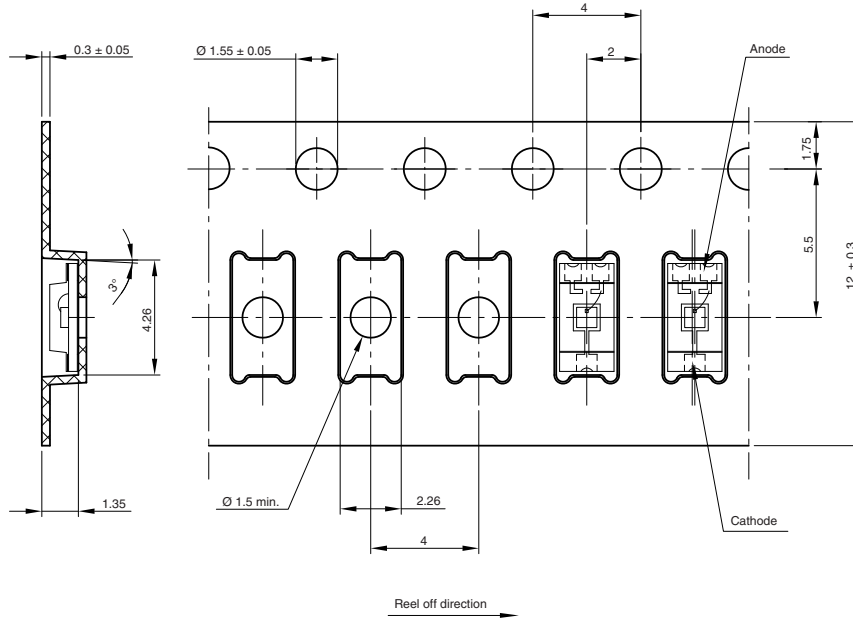
FLOOR LIFE

Time between soldering and removing from MBB must not exceed the time indicated in J-STD-020:
 Moisture sensitivity: level 3
 Floor life: 168 h
 Conditions: $T_{amb} < 30\text{ }^{\circ}\text{C}$, $\text{RH} < 60\%$

DRYING

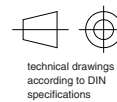
In case of moisture absorption devices should be baked before soldering. Conditions see J-STD-020 or label. Devices taped on reel dry using recommended conditions:
 192 h at $40\text{ }^{\circ}\text{C}$ (+ 5 °C), $\text{RH} < 5\%$
 or
 96 h at $60\text{ }^{\circ}\text{C}$ (+ 5 °C), $\text{RH} < 5\%$.

BLISTER TAPE DIMENSIONS in millimeters



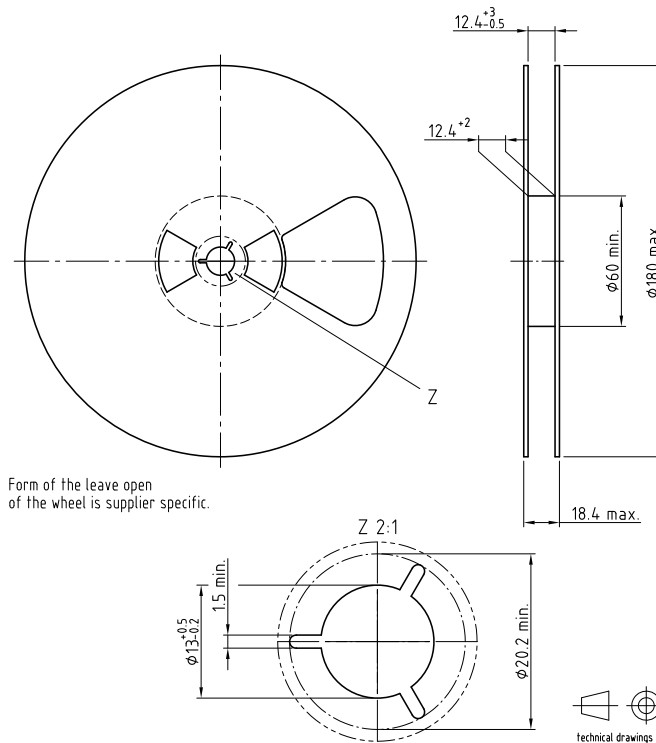
Drawing-No.: 9.700-5329.02-4
 Issue: 2; 31.08.09
 20877

Not indicated tolerances ±0.1



REEL DIMENSIONS in millimeters

Volume: 3000 pcs/reel



Form of the leave open of the wheel is supplier specific.

Drawing-No.: 9.800-5097.01-4
 Issue: 1; 05.05.08
 20874





Disclaimer

ALL PRODUCT, PRODUCT SPECIFICATIONS AND DATA ARE SUBJECT TO CHANGE WITHOUT NOTICE TO IMPROVE RELIABILITY, FUNCTION OR DESIGN OR OTHERWISE.

Vishay Intertechnology, Inc., its affiliates, agents, and employees, and all persons acting on its or their behalf (collectively, "Vishay"), disclaim any and all liability for any errors, inaccuracies or incompleteness contained in any datasheet or in any other disclosure relating to any product.

Vishay makes no warranty, representation or guarantee regarding the suitability of the products for any particular purpose or the continuing production of any product. To the maximum extent permitted by applicable law, Vishay disclaims (i) any and all liability arising out of the application or use of any product, (ii) any and all liability, including without limitation special, consequential or incidental damages, and (iii) any and all implied warranties, including warranties of fitness for particular purpose, non-infringement and merchantability.

Statements regarding the suitability of products for certain types of applications are based on Vishay's knowledge of typical requirements that are often placed on Vishay products in generic applications. Such statements are not binding statements about the suitability of products for a particular application. It is the customer's responsibility to validate that a particular product with the properties described in the product specification is suitable for use in a particular application. Parameters provided in datasheets and/or specifications may vary in different applications and performance may vary over time. All operating parameters, including typical parameters, must be validated for each customer application by the customer's technical experts. Product specifications do not expand or otherwise modify Vishay's terms and conditions of purchase, including but not limited to the warranty expressed therein.

Except as expressly indicated in writing, Vishay products are not designed for use in medical, life-saving, or life-sustaining applications or for any other application in which the failure of the Vishay product could result in personal injury or death. Customers using or selling Vishay products not expressly indicated for use in such applications do so at their own risk. Please contact authorized Vishay personnel to obtain written terms and conditions regarding products designed for such applications.

No license, express or implied, by estoppel or otherwise, to any intellectual property rights is granted by this document or by any conduct of Vishay. Product names and markings noted herein may be trademarks of their respective owners.

Material Category Policy

Vishay Intertechnology, Inc. hereby certifies that all its products that are identified as RoHS-Compliant fulfill the definitions and restrictions defined under Directive 2011/65/EU of The European Parliament and of the Council of June 8, 2011 on the restriction of the use of certain hazardous substances in electrical and electronic equipment (EEE) - recast, unless otherwise specified as non-compliant.

Please note that some Vishay documentation may still make reference to RoHS Directive 2002/95/EC. We confirm that all the products identified as being compliant to Directive 2002/95/EC conform to Directive 2011/65/EU.

Vishay Intertechnology, Inc. hereby certifies that all its products that are identified as Halogen-Free follow Halogen-Free requirements as per JEDEC JS709A standards. Please note that some Vishay documentation may still make reference to the IEC 61249-2-21 definition. We confirm that all the products identified as being compliant to IEC 61249-2-21 conform to JEDEC JS709A standards.