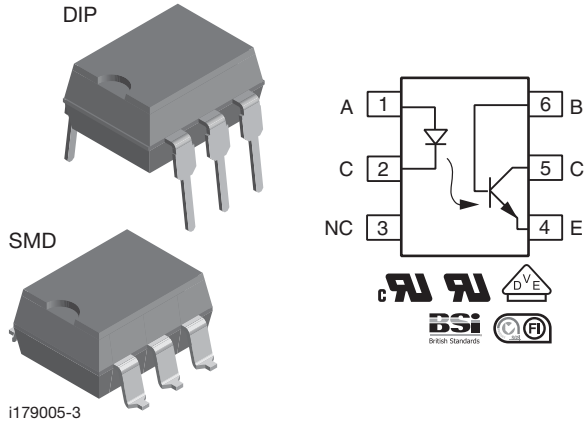


## Optocoupler, Phototransistor Output, Low Input Current, with Base Connection


**FEATURES**

- Guaranteed at  $I_F = 1.0 \text{ mA}$
- High collector emitter voltage,  $BV_{CEO} = 70 \text{ V}$
- Long term stability
- Industry standard DIP package
- Compliant to RoHS Directive 2002/95/EC and in accordance to WEEE 2002/96/EC


**RoHS  
COMPLIANT**
**AGENCY APPROVALS**

- UL file no. E52744 system code H, double protection
- cUL tested to CSA 22.2 bulletin 5A
- DIN EN 60747-5-2 (VDE 0884)/DIN EN 60747-5-5 (pending), available with option 1
- BSI: EN 60065:2002, EN 60950-1:2006
- FIMKO

**DESCRIPTION**

The IL202, IL203 is optically coupled pairs employing a gallium arsenide infrared LED and a silicon NPN phototransistor. Signal information, including a DC level, can be transmitted by the device while maintaining a high degree of electrical isolation between input and output. The IL202, IL203 can be used to replace relays and transformers in many digital interface applications, as well as analog applications such as CRT modulation.

<b>ORDERING INFORMATION</b>		
<div style="display: flex; justify-content: space-around; align-items: center;"> <div style="text-align: center;"> <span style="border: 1px solid black; padding: 2px;">I</span> <span style="border: 1px solid black; padding: 2px;">L</span> <span style="border: 1px solid black; padding: 2px;">2</span> <span style="border: 1px solid black; padding: 2px;">0</span> <span style="border: 1px solid black; padding: 2px;">#</span> </div> <div style="text-align: center;">-</div> <div style="text-align: center;"> <span style="border: 1px solid black; padding: 2px;">X</span> <span style="border: 1px solid black; padding: 2px;">0</span> <span style="border: 1px solid black; padding: 2px;">0</span> <span style="border: 1px solid black; padding: 2px;">#</span> </div> <div style="text-align: center;"> <span style="border: 1px solid black; padding: 2px;">T</span> </div> </div> <div style="display: flex; justify-content: space-around; margin-top: 5px;"> <div style="text-align: center;">PART NUMBER</div> <div style="text-align: center;">PACKAGE OPTION</div> <div style="text-align: center;">TAPE AND REEL</div> </div>		
AGENCY CERTIFIED/PACKAGE	CTR (%)	
<b>UL, cUL, BSI, FIMKO</b>	<b>125 to 250</b>	<b>225 to 450</b>
DIP-6	-	IL203
SMD-6, option 9	-	IL203-X009T
<b>VDE, UL, cUL, BSI, FIMKO</b>	<b>125 to 250</b>	<b>225 to 450</b>
DIP-6	IL202-X001	-

## Vishay Semiconductors Optocoupler, Phototransistor Output, Low Input Current, with Base Connection

<b>ABSOLUTE MAXIMUM RATINGS</b> ( $T_{amb} = 25\text{ }^{\circ}\text{C}$ , unless otherwise specified)				
PARAMETER	TEST CONDITION	SYMBOL	VALUE	UNIT
<b>INPUT</b>				
Peak reverse voltage		$V_R$	6.0	V
Forward continuous current		$I_F$	60	mA
Power dissipation		$P_{diss}$	100	mW
Derate linearly from 25 °C			1.33	mW/°C
<b>OUTPUT</b>				
Collector emitter breakdown voltage		$BV_{CEO}$	70	V
Emitter collector breakdown voltage		$BV_{ECO}$	7.0	V
Collector base breakdown voltage		$BV_{CBO}$	70	V
Power dissipation		$P_{diss}$	200	mW
Derate linearly from 25 °C			2.6	mW/°C
<b>COUPLER</b>				
Isolation test voltage	$t = 1.0\text{ s}$	$V_{ISO}$	5300	$V_{RMS}$
Total package dissipation (LED and detector)		$P_{tot}$	250	mW
Derate linearly from 25 °C			3.3	mW/°C
Creepage distance			$\geq 7.0$	mm
Clearance distance			$\geq 7.0$	mm
Storage temperature		$T_{stg}$	- 55 to + 150	°C
Operating temperature		$T_{amb}$	- 55 to + 100	°C
Lead soldering time	$\leq 260\text{ }^{\circ}\text{C}$		10	s

### Note

- Stresses in excess of the absolute maximum ratings can cause permanent damage to the device. Functional operation of the device is not implied at these or any other conditions in excess of those given in the operational sections of this document. Exposure to absolute maximum ratings for extended periods of the time can adversely affect reliability.

<b>ELECTRICAL CHARACTERISTICS</b> ( $T_{amb} = 25\text{ }^{\circ}\text{C}$ , unless otherwise specified)						
PARAMETER	TEST CONDITION	SYMBOL	MIN.	TYP.	MAX.	UNIT
<b>INPUT</b>						
Forward voltage	$I_F = 20\text{ mA}$	$V_F$		1.2	1.5	V
	$I_F = 1.0\text{ mA}$	$V_F$		1.0	1.2	V
Breakdown voltage	$I_R = 10\text{ }\mu\text{A}$	$V_F$	6.0	20		V
Reverse current	$V_R = 6.0\text{ V}$	$I_R$		0.1	10	$\mu\text{A}$
<b>OUTPUT</b>						
DC forward current gain	$V_{CE} = 5.0\text{ V}, I_C = 100\text{ }\mu\text{A}$	$h_{FE}$	100	200		
Collector emitter breakdown voltage	$I_C = 100\text{ }\mu\text{A}$	$BV_{CEO}$	70			V
Emitter collector breakdown voltage	$I_E = 100\text{ }\mu\text{A}$	$BV_{ECO}$	7.0	10		V
Collector base breakdown voltage	$I_C = 10\text{ }\mu\text{A}$	$BV_{CBO}$	70	90		V
Leakage current collector emitter	$V_{CE} = 10\text{ V}, T_A = 25\text{ }^{\circ}\text{C}$	$I_{CEO}$		5.0	50	nA

### Note

- Minimum and maximum values are testing requirements. Typical values are characteristics of the device and are the result of engineering evaluation. Typical values are for information only and are not part of the testing requirements.

<b>CURRENT TRANSFER RATIO</b> ( $T_{amb} = 25\text{ }^{\circ}\text{C}$ , unless otherwise specified)							
PARAMETER	TEST CONDITION	PART	SYMBOL	MIN.	TYP.	MAX.	UNIT
Current transfer ratio (collector to base)	$I_F = 10\text{ mA}, V_{CB} = 10\text{ V}$		$CTR_{CB}$	15			%
Collector emitter saturation voltage	$I_F = 10\text{ mA}, I_C = 2.0\text{ mA}$		$V_{CEsat}$			0.4	V
DC current transfer ratio	$I_F = 10\text{ mA}, V_{CE} = 10\text{ V}$	IL202	$CTR_{DC}$	125	200	250	%
		IL203	$CTR_{DC}$	225	300	450	%
	$I_F = 1.0\text{ mA}, V_{CE} = 10\text{ V}$	IL202	$CTR_{DC}$	30			%
		IL203	$CTR_{DC}$	50			%

Optocoupler, Phototransistor Output, Vishay Semiconductors  
 Low Input Current, with Base Connection

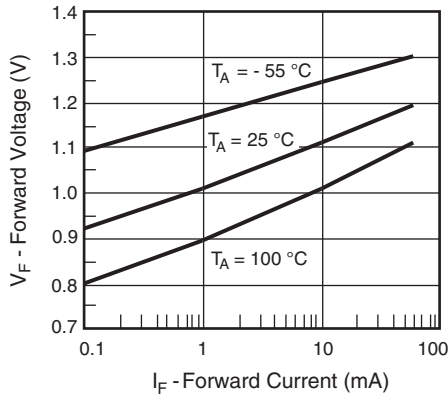
**TYPICAL CHARACTERISTICS** ( $T_{amb} = 25\text{ }^{\circ}\text{C}$ , unless otherwise specified)


Fig. 1 - Forward Voltage vs. Forward Current

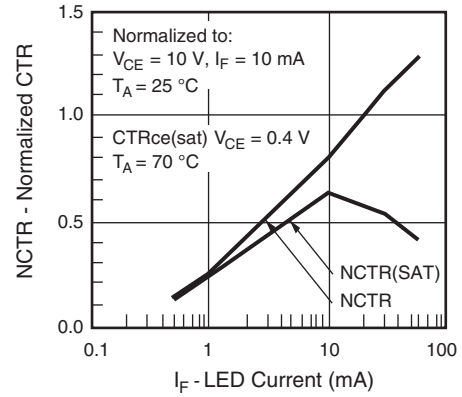


Fig. 4 - Normalized Non-Saturated and Saturated CTR vs. LED Current

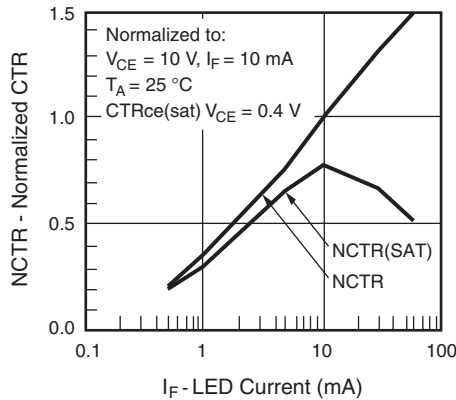


Fig. 2 - Normalized Non-Saturated and Saturated CTR vs. LED Current

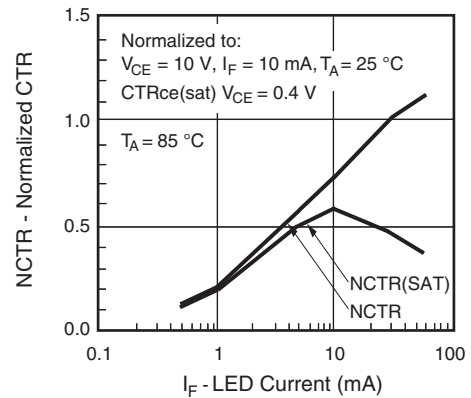


Fig. 5 - Normalized Non-Saturated and Saturated CTR vs. LED Current

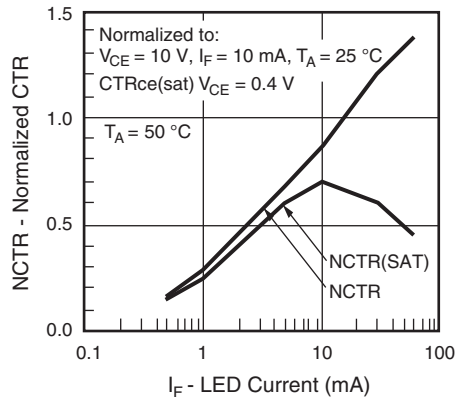


Fig. 3 - Normalized Non-Saturated and Saturated CTR vs. LED Current

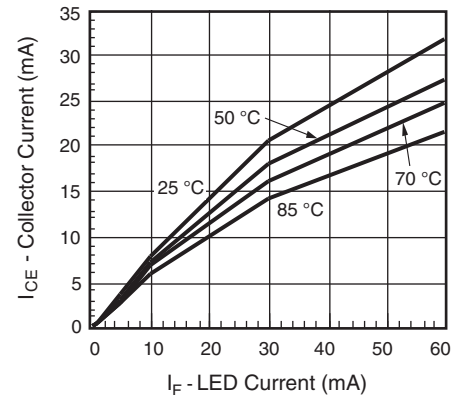


Fig. 6 - Collector Emitter Current vs. Temperature and LED Current

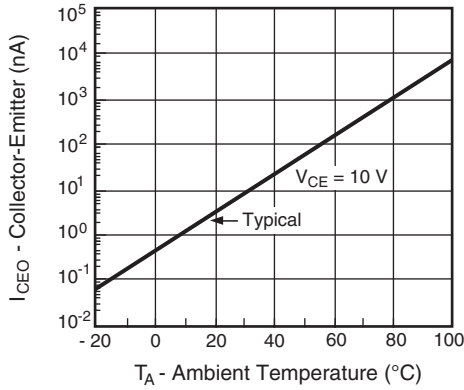


Fig. 7 - Collector Emitter Leakage Current vs. Temperature

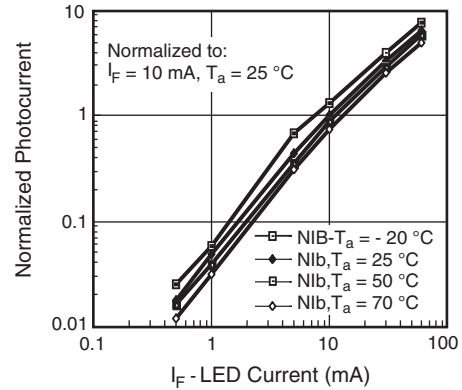


Fig. 10 - Normalized Photocurrent vs.  $I_F$  and Temperature

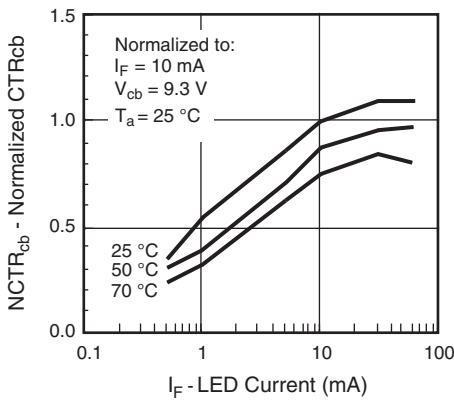


Fig. 8 - Normalized  $CTR_{cb}$  vs. LED Current and Temperature

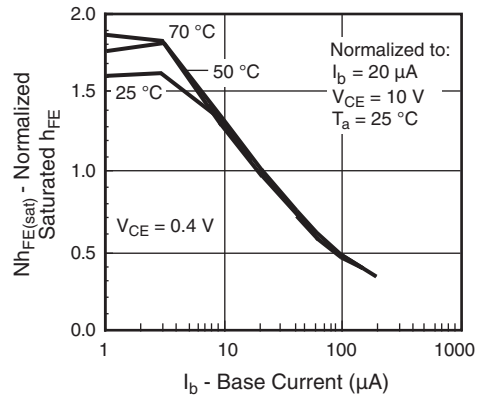


Fig. 11 - Normalized Saturated  $h_{FE}$  vs. Base Current and Temperature

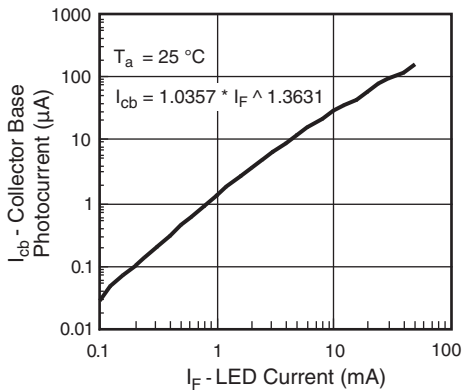


Fig. 9 - Collector Base Photocurrent vs. LED Current

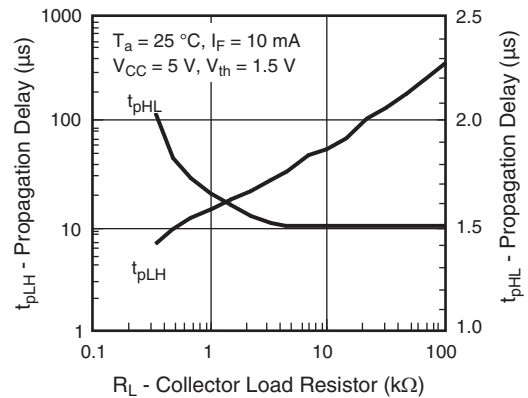


Fig. 12 - Propagation Delay vs. Collector Load Resistor

# Optocoupler, Phototransistor Output, Vishay Semiconductors Low Input Current, with Base Connection

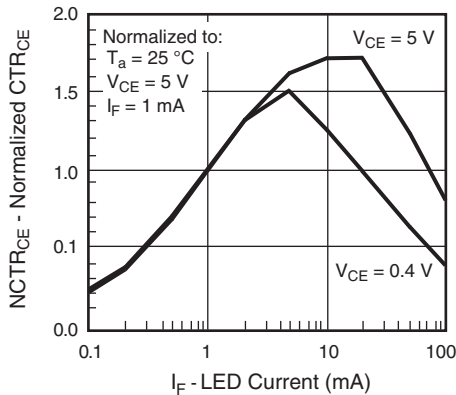


Fig. 13 - Normalized Non-Saturated and Saturated CTR<sub>CE</sub> vs. LED Current

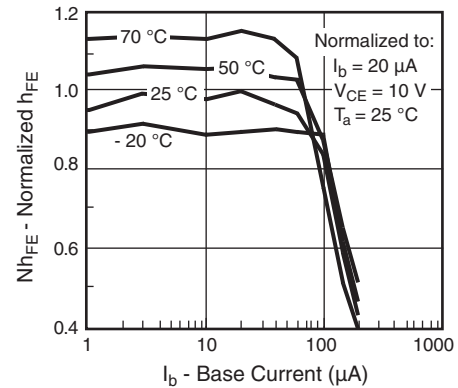
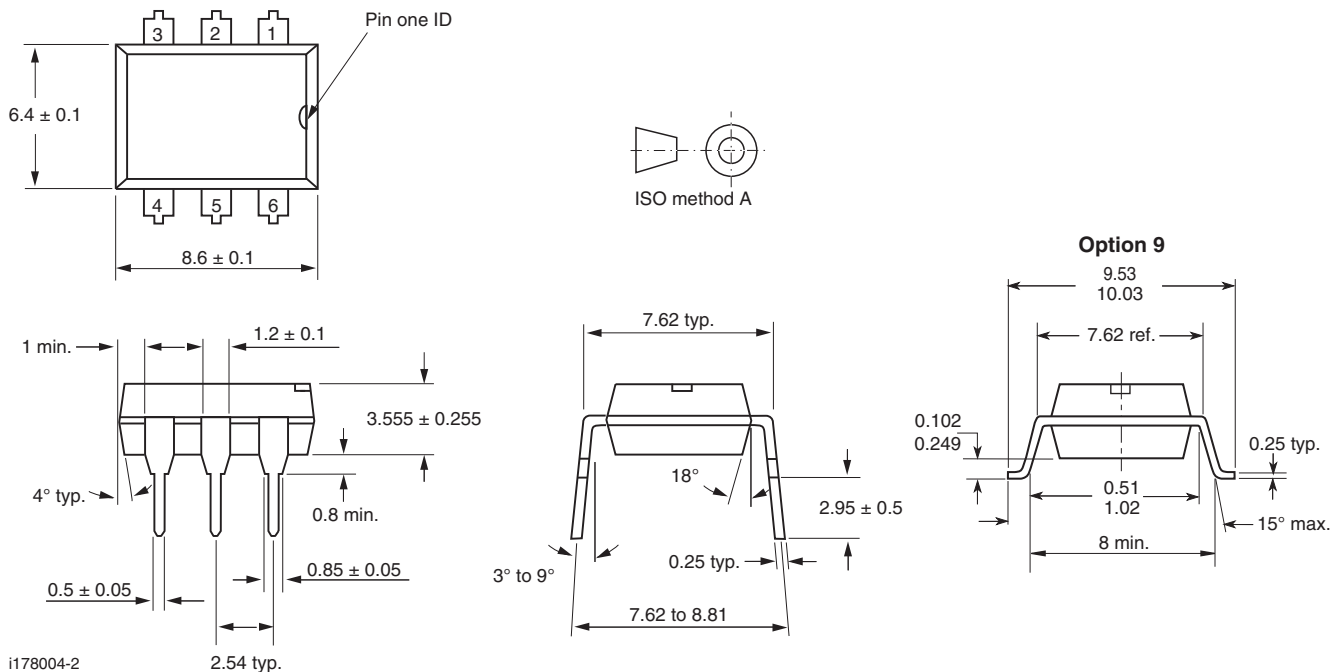


Fig. 14 - Normalized Non-Saturated h<sub>FE</sub> vs. Base Current and Temperature

### PACKAGE DIMENSIONS in millimeters



### PACKAGE MARKING (example)



#### Notes

- Only option 1 is reflected in the package marking
- The VDE logo is only marked on option 1 parts
- Tape and reel suffix (T) is not part of the package marking



## Disclaimer

ALL PRODUCT, PRODUCT SPECIFICATIONS AND DATA ARE SUBJECT TO CHANGE WITHOUT NOTICE TO IMPROVE RELIABILITY, FUNCTION OR DESIGN OR OTHERWISE.

Vishay Intertechnology, Inc., its affiliates, agents, and employees, and all persons acting on its or their behalf (collectively, "Vishay"), disclaim any and all liability for any errors, inaccuracies or incompleteness contained in any datasheet or in any other disclosure relating to any product.

Vishay makes no warranty, representation or guarantee regarding the suitability of the products for any particular purpose or the continuing production of any product. To the maximum extent permitted by applicable law, Vishay disclaims (i) any and all liability arising out of the application or use of any product, (ii) any and all liability, including without limitation special, consequential or incidental damages, and (iii) any and all implied warranties, including warranties of fitness for particular purpose, non-infringement and merchantability.

Statements regarding the suitability of products for certain types of applications are based on Vishay's knowledge of typical requirements that are often placed on Vishay products in generic applications. Such statements are not binding statements about the suitability of products for a particular application. It is the customer's responsibility to validate that a particular product with the properties described in the product specification is suitable for use in a particular application. Parameters provided in datasheets and/or specifications may vary in different applications and performance may vary over time. All operating parameters, including typical parameters, must be validated for each customer application by the customer's technical experts. Product specifications do not expand or otherwise modify Vishay's terms and conditions of purchase, including but not limited to the warranty expressed therein.

Except as expressly indicated in writing, Vishay products are not designed for use in medical, life-saving, or life-sustaining applications or for any other application in which the failure of the Vishay product could result in personal injury or death. Customers using or selling Vishay products not expressly indicated for use in such applications do so at their own risk. Please contact authorized Vishay personnel to obtain written terms and conditions regarding products designed for such applications.

No license, express or implied, by estoppel or otherwise, to any intellectual property rights is granted by this document or by any conduct of Vishay. Product names and markings noted herein may be trademarks of their respective owners.

## Material Category Policy

**Vishay Intertechnology, Inc. hereby certifies that all its products that are identified as RoHS-Compliant fulfill the definitions and restrictions defined under Directive 2011/65/EU of The European Parliament and of the Council of June 8, 2011 on the restriction of the use of certain hazardous substances in electrical and electronic equipment (EEE) - recast, unless otherwise specified as non-compliant.**

**Please note that some Vishay documentation may still make reference to RoHS Directive 2002/95/EC. We confirm that all the products identified as being compliant to Directive 2002/95/EC conform to Directive 2011/65/EU.**

**Vishay Intertechnology, Inc. hereby certifies that all its products that are identified as Halogen-Free follow Halogen-Free requirements as per JEDEC JS709A standards. Please note that some Vishay documentation may still make reference to the IEC 61249-2-21 definition. We confirm that all the products identified as being compliant to IEC 61249-2-21 conform to JEDEC JS709A standards.**