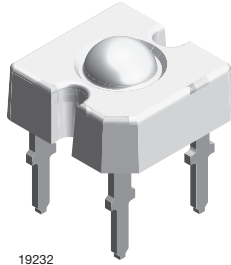


TELUX LED



19232

DESCRIPTION

The TELUX series is a clear, non diffused LED for applications where supreme luminous flux is required.

It is designed in an industry standard 7.62 mm square package utilizing highly developed with super bright, AlInGaP technology.

The supreme heat dissipation of TELUX allows applications at high ambient temperatures.

All packing units are binned for luminous flux, forward voltage, and color to achieve the most homogenous light appearance in application.

PRODUCT GROUP AND PACKAGE DATA

- Product group: LED
- Package: TELUX
- Product series: power
- Angle of half intensity: $\pm 55^\circ$

FEATURES

- High luminous flux
- Supreme heat dissipation: R_{thJP} is 90 K/W
- High operating temperature:
 $T_{amb} = -40^\circ\text{C}$ to $+110^\circ\text{C}$
- Meets SAE and ECE color requirements for the automobile industry for color red
- Packed in tubes for automatic insertion
- Luminous flux, forward voltage, and color categorized for each tube
- Small mechanical tolerances allow precise usage of external reflectors or lightguides
- Compatible with wave solder processes according to CECC 00802
- ESD-withstand voltage: Up to 2 kV according to JESD 22-A114-B
- AEC-Q101 qualified
- Material categorization: For definitions of compliance please see www.vishay.com/doc?99912



RoHS
COMPLIANT
HALOGEN
FREE
GREEN
(5-2008)

APPLICATIONS

- Exterior lighting
- Dashboard illumination
- Tail-, stop-, and turn signals of motor vehicles
- Replaces small incandescent lamps
- Traffic signals and signs

PARTS TABLE

PART	COLOR	LUMINOUS FLUX (mIm)			at I_F (mA)	WAVELENGTH (nm)			at I_F (mA)	FORWARD VOLTAGE (V)			at I_F (mA)	TECHNOLOGY
		MIN.	TYP.	MAX.		MIN.	TYP.	MAX.		MIN.	TYP.	MAX.		
TLWR9000	Red	2500	3200	-	70	611	615	634	70	1.83	2.2	2.67	70	AlInGaP on GaAs

ABSOLUTE MAXIMUM RATINGS ($T_{amb} = 25^\circ\text{C}$, unless otherwise specified)

PARAMETER	TEST CONDITION	SYMBOL	VALUE	UNIT
Reverse voltage	$I_R = 100 \mu\text{A}$	V_R	10	V
DC forward current	$T_{amb} \leq 85^\circ\text{C}$	I_F	70	mA
Surge forward current	$t_p \leq 10 \mu\text{s}$	I_{FSM}	0.1	A
Power dissipation	$T_{amb} \leq 85^\circ\text{C}$	P_V	187	mW
Junction temperature		T_j	125	$^\circ\text{C}$
Operating temperature range		T_{amb}	-40 to +110	$^\circ\text{C}$
Storage temperature range		T_{stg}	-55 to +110	$^\circ\text{C}$
Soldering temperature	$t \leq 5 \text{ s}$, 1.5 mm from body preheat temperature $100^\circ\text{C}/30 \text{ s}$	T_{sd}	260	$^\circ\text{C}$
Thermal resistance junction/ambient	With anode heatsink of 70 mm^2	R_{thJA}	200	K/W

OPTICAL AND ELECTRICAL CHARACTERISTICS ($T_{amb} = 25\text{ }^{\circ}\text{C}$, unless otherwise specified)						
TLWR9000, RED						
PARAMETER	TEST CONDITION	SYMBOL	MIN.	TYP.	MAX.	UNIT
Total flux	$I_F = 70\text{ mA}$, $R_{thJA} = 200\text{ K/W}$	ϕ_V	2500	3200	-	lm
Luminous intensity/total flux	$I_F = 70\text{ mA}$, $R_{thJA} = 200\text{ K/W}$	I_V/ϕ_V	-	0.5	-	mcd/lm
Dominant wavelength	$I_F = 70\text{ mA}$, $R_{thJA} = 200\text{ K/W}$	λ_d	611	615	634	nm
Peak wavelength	$I_F = 70\text{ mA}$, $R_{thJA} = 200\text{ K/W}$	λ_p	-	624	-	nm
Angle of half intensity	$I_F = 70\text{ mA}$, $R_{thJA} = 200\text{ K/W}$	φ	-	± 55	-	deg
Forward voltage	$I_F = 70\text{ mA}$, $R_{thJA} = 200\text{ K/W}$	V_F	1.83	2.2	2.67	V
Reverse voltage		V_R	10	20	-	V
Temperature coefficient of λ_{dom}	$I_F = 70\text{ mA}$	$T_C\lambda_{dom}$	-	17	-	nm/K
Temperature coefficient of V_F	$I_F = 70\text{ mA}$, $T > 25\text{ }^{\circ}\text{C}$	T_{CVF}	-	-2.9	-	mV/K

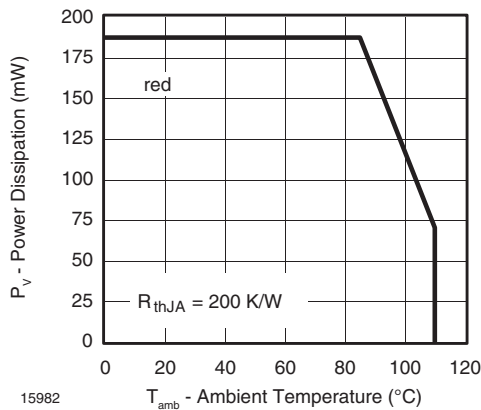
TYPICAL CHARACTERISTICS ($T_{amb} = 25\text{ }^{\circ}\text{C}$, unless otherwise specified)


Fig. 1 - Forward Current vs. Ambient Temperature

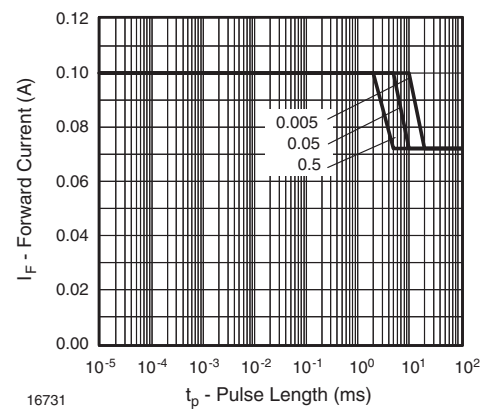


Fig. 3 - Forward Current vs. Pulse Length

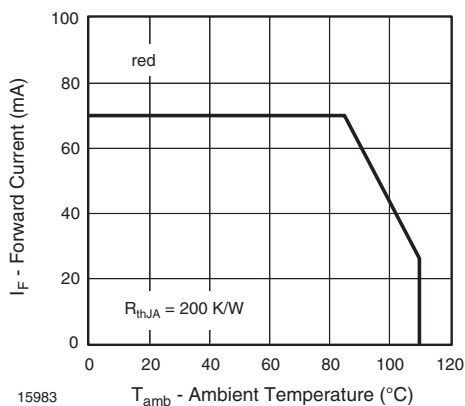


Fig. 2 - Forward Current vs. Ambient Temperature

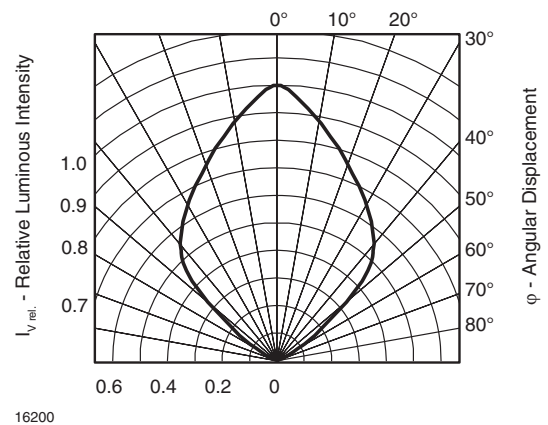


Fig. 4 - Relative Luminous Intensity vs. Angular Displacement

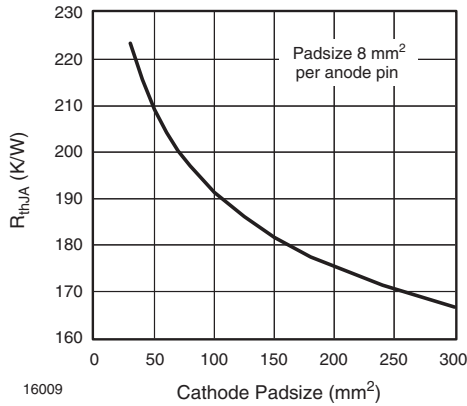
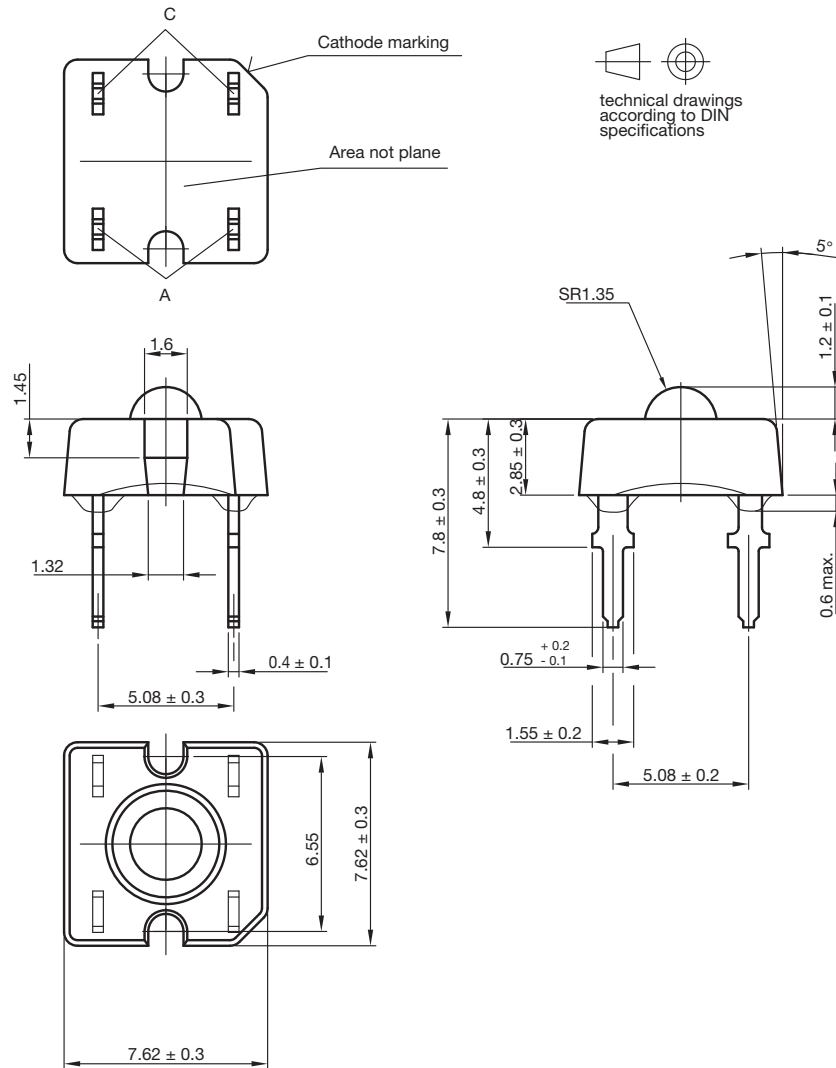


Fig. 5 - Thermal Resistance Junction Ambient vs. Cathode Padsize

PACKAGE DIMENSIONS in millimeters



Drawing-No.: 6.544-5321.02-4
Issue: 3; 26.06.06



Disclaimer

ALL PRODUCT, PRODUCT SPECIFICATIONS AND DATA ARE SUBJECT TO CHANGE WITHOUT NOTICE TO IMPROVE RELIABILITY, FUNCTION OR DESIGN OR OTHERWISE.

Vishay Intertechnology, Inc., its affiliates, agents, and employees, and all persons acting on its or their behalf (collectively, "Vishay"), disclaim any and all liability for any errors, inaccuracies or incompleteness contained in any datasheet or in any other disclosure relating to any product.

Vishay makes no warranty, representation or guarantee regarding the suitability of the products for any particular purpose or the continuing production of any product. To the maximum extent permitted by applicable law, Vishay disclaims (i) any and all liability arising out of the application or use of any product, (ii) any and all liability, including without limitation special, consequential or incidental damages, and (iii) any and all implied warranties, including warranties of fitness for particular purpose, non-infringement and merchantability.

Statements regarding the suitability of products for certain types of applications are based on Vishay's knowledge of typical requirements that are often placed on Vishay products in generic applications. Such statements are not binding statements about the suitability of products for a particular application. It is the customer's responsibility to validate that a particular product with the properties described in the product specification is suitable for use in a particular application. Parameters provided in datasheets and/or specifications may vary in different applications and performance may vary over time. All operating parameters, including typical parameters, must be validated for each customer application by the customer's technical experts. Product specifications do not expand or otherwise modify Vishay's terms and conditions of purchase, including but not limited to the warranty expressed therein.

Except as expressly indicated in writing, Vishay products are not designed for use in medical, life-saving, or life-sustaining applications or for any other application in which the failure of the Vishay product could result in personal injury or death. Customers using or selling Vishay products not expressly indicated for use in such applications do so at their own risk. Please contact authorized Vishay personnel to obtain written terms and conditions regarding products designed for such applications.

No license, express or implied, by estoppel or otherwise, to any intellectual property rights is granted by this document or by any conduct of Vishay. Product names and markings noted herein may be trademarks of their respective owners.

Material Category Policy

Vishay Intertechnology, Inc. hereby certifies that all its products that are identified as RoHS-Compliant fulfill the definitions and restrictions defined under Directive 2011/65/EU of The European Parliament and of the Council of June 8, 2011 on the restriction of the use of certain hazardous substances in electrical and electronic equipment (EEE) - recast, unless otherwise specified as non-compliant.

Please note that some Vishay documentation may still make reference to RoHS Directive 2002/95/EC. We confirm that all the products identified as being compliant to Directive 2002/95/EC conform to Directive 2011/65/EU.

Vishay Intertechnology, Inc. hereby certifies that all its products that are identified as Halogen-Free follow Halogen-Free requirements as per JEDEC JS709A standards. Please note that some Vishay documentation may still make reference to the IEC 61249-2-21 definition. We confirm that all the products identified as being compliant to IEC 61249-2-21 conform to JEDEC JS709A standards.