

SmartWire-DT



XV Series HMI-PLC with SmartWire-DT



## 9.1 SmartWire-DT Panel Wiring Solution

System Overview	
Product Description	V7-T9-2
Features	V7-T9-2
System Overview Diagram	V7-T9-3
System Components	
Product Description	V7-T9-6
Product Selection	V7-T9-7
Accessories	V7-T9-8
System Controllers	
Product Description	V7-T9-11
Features	V7-T9-11
Standards and Certifications	V7-T9-11
Contactor Modules	
Product Description	V7-T9-12
Features	V7-T9-12
Product Identification	V7-T9-13
Product Selection	V7-T9-14
Pilot Device Modules	
Product Description	V7-T9-15
Features	V7-T9-15
Product Identification	V7-T9-16
Product Selection	V7-T9-18
Technical Data and Specifications	V7-T9-20
Dimensions	V7-T9-34

SmartWire-DT Panel Wiring Solution



### System Overview

#### Product Description

The SmartWire-DT system uses a continuous green flat cable located in the control cabinet to connect motor starters, pushbutton actuators, and indicator lights. It eliminates the need for most of the conventional point-to-point control wiring—and even integrates 24 Vdc control power for contactor coils on the eight conductor flat cable. The start of the SmartWire-DT system is a gateway—it establishes the connection to standard programmable logic controller (PLC) fieldbuses, such as EtherNet/IP, Modbus TCP, PROFIBUS-DP and CANopen. Because SmartWire-DT directly integrates the input/output (I/O) level in the switching devices, no conventional PLC I/O modules are needed—instead communication enabled modules are attached to standard Eaton motor control components. Thus, the PLC in the control cabinet simply consists of a central processing unit (CPU) module.

Typical faults such as loose connections and miswired terminations are eliminated using the flat cable and the specialized connectors. Furthermore, each SmartWire-DT enabled device has individual diagnostic LEDs built in, which reduce commissioning time and troubleshooting in the field.

### Contents

#### Description

	<i>Page</i>
SmartWire-DT Panel Wiring Solution	
System Components	<b>V7-T9-6</b>
System Controllers	<b>V7-T9-11</b>
Contactor Modules	<b>V7-T9-12</b>
Pilot Device Modules	<b>V7-T9-15</b>
Technical Data and Specifications	<b>V7-T9-20</b>
Dimensions	<b>V7-T9-34</b>

Nodes on the SmartWire-DT network are automatically assigned addresses on the gateway with the push of a button—assigning addresses in the order that the nodes are connected. The system employs time monitoring and a watchdog timeout using the established target configuration as a reference—safely monitoring the integrity of the control scheme. SmartWire-DT has a maximum network length of 2000 ft, can be extended to pushbutton control stations outside of the control cabinet, and can connect up to 99 nodes per gateway. A software program called SWD-Assist enables the layout, planning, and system configuration of a SmartWire-DT network.

#### Features

- Connects directly to standard XTCE contactors, XTRE control relays, and M22 pilot devices
- Supports EtherNet/IP, Modbus TCP, PROFIBUS-DP and CANopen fieldbuses
- Supports up to 99 nodes on Ethernet and CANopen, and 58 nodes on PROFIBUS-DP
- Automatically assigns addresses to SmartWire-DT nodes
- Integrates and supplies 24 Vdc power to contactor and relay coils over the network
- Includes diagnostic bi-color LEDs on each node connection

### System Overview Diagram

#### SmartWire-DT Connection System

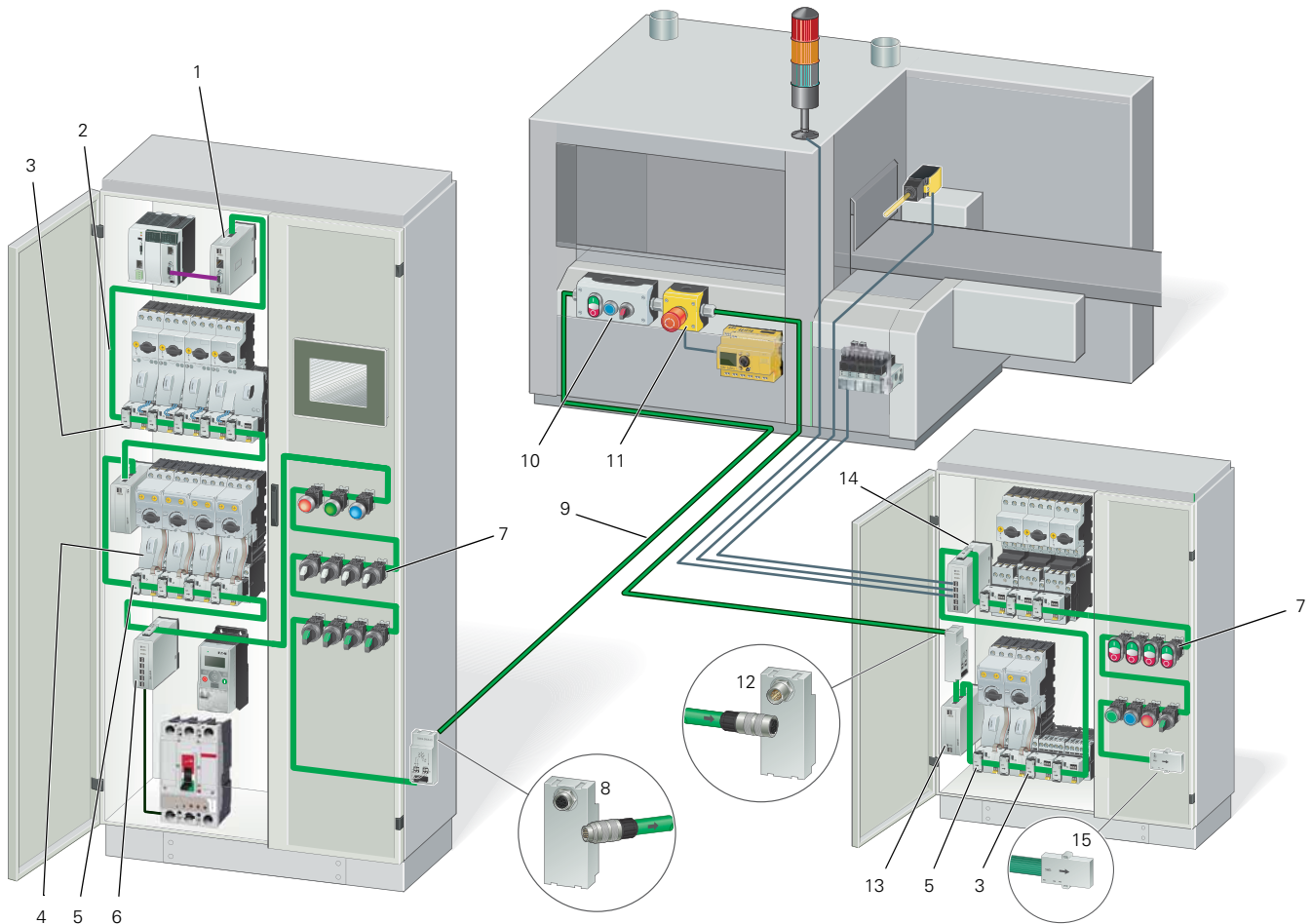

9

Item Number	Description
1	Gateway to PLC fieldbus network
2	Flat cable
3	Modules for XT contactors with XTPR manual motor protectors
4	Powerfeed module 1 (optional 24 Vdc power feeder)
5	Modules for XT contactors with XTPE electronic manual motor protectors
6	Digital I/O module
7	Modules for M22 pilot devices
8	Cabinet cable adapter socket

Item Number	Description
9	Round cable
10	Pilot device control station
11	Emergency stop control station
12	Cabinet cable adapter plug
13	Powerfeed module 2 (optional 15 Vdc and 24 Vdc power feeder)
14	Digital I/O module (for connection of sensors and actuators)
15	Terminating resistor

# 9.1

## Connectivity Solutions

### SmartWire-DT Panel Wiring Solution

#### System Components Overview

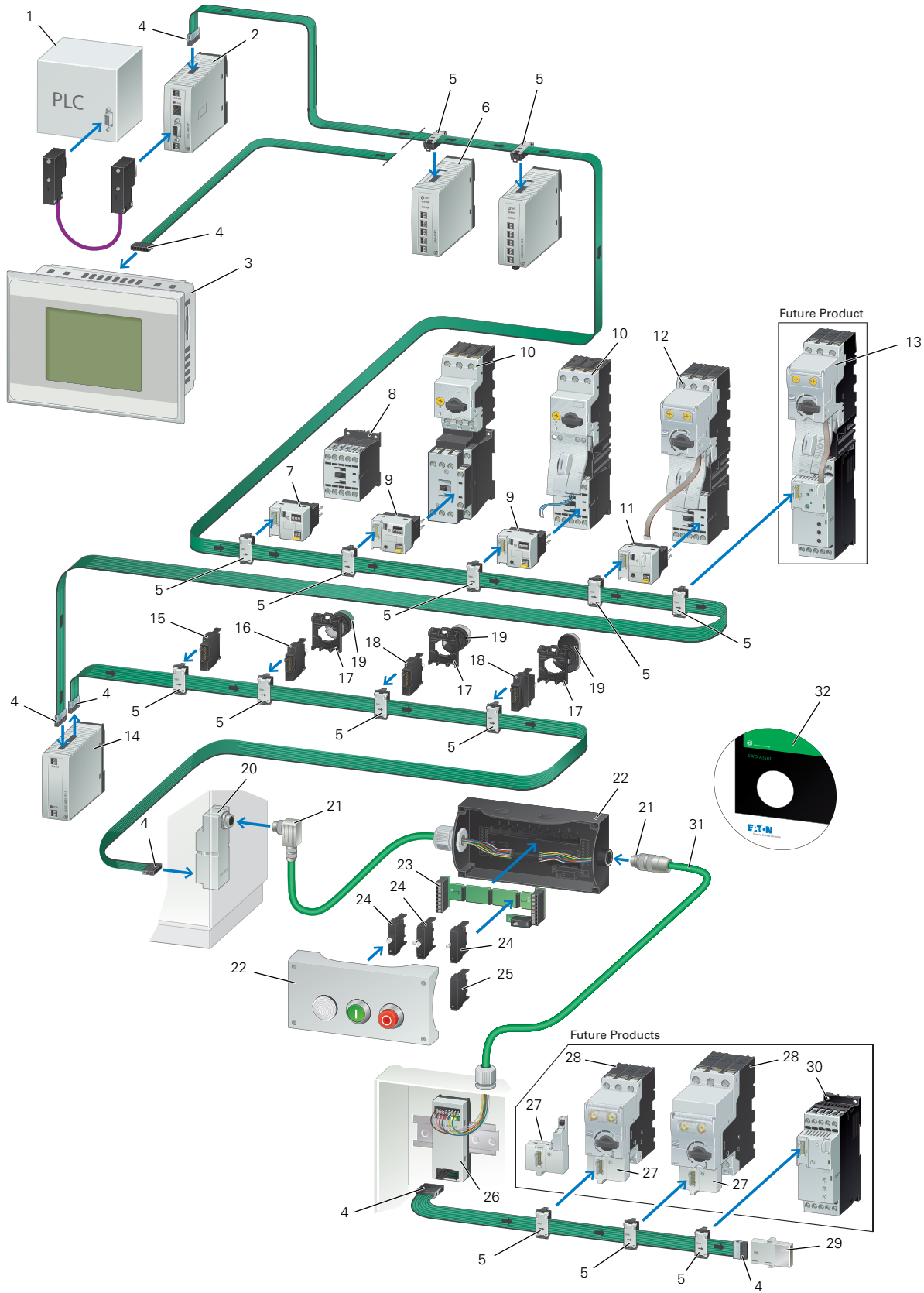

Item Number	Description
1	Programmable logic controller (PLC)
2	Gateway
3	XV HMI-PLC
4	Flat plugs
5	Device plug
6	I/O modules
7	Contactormodule
8	XT Contactors
9	Contactormodule with HOA switch
10	XTPR manual motor controller
11	PKE contactormodule
12	XTPE manual motor controller
13	Soft starter DS7 with electronic motor protection from XTPE
14	Powerfeed module
15	Universal module, front mount
16	M22 LED elements, front mount

Item Number	Description
17	M22 mounting adapter
18	SmartWire-DT M22 modules
19	M22 pilot devices
20	Cabinet cable adapter
21	Plug connector
22	M22 surface mounting enclosure
23	PCB module for M22 pushbutton stations
24	M22 modules, base mount
25	Universal module, base mount
26	Adapter for flat/round cable for DIN rail mounting
27	XTPE module (manual motor protection)
28	XTPE manual motor protector
29	Terminating resistor
30	DS7 soft starters
31	Round cable, 8-pole
32	SmartWire-DT configuration software, SWD-Assist

#### System Components



### System Components

#### Product Description

The start of the SmartWire-DT system is a gateway module. The gateway connects as a node to a programmable logic controller (PLC) fieldbus. The PLC used must have a fieldbus polling master module or input/output (I/O) scanner card so that the gateway can connect as a node on the fieldbus network. SmartWire-DT can connect to EtherNet/IP, Modbus TCP, PROFIBUS-DP and CANopen fieldbuses. To plan and lay out a SmartWire-DT network, a MS Windows compatible software program called SWD-Assist is available as a free download from the Eaton website. The SWD-Assist configuration software will calculate the control power requirements needed and generate a bill of materials of all the required components.

#### Gateway Modules

Gateway modules connect the SmartWire-DT system to the PLC. They are connected as nodes to the existing PLC fieldbus and are the start of the SmartWire-DT connection system. Gateways are available with Ethernet, PROFIBUS-DP and CANopen protocols.

#### Powerfeed Modules

Powerfeed modules feed auxiliary 24 Vdc power and/or 15 Vdc network power into the SmartWire-DT flat cable. The auxiliary 24 Vdc power is needed for the power supply of contactors and the 15 Vdc network power is used for supplying power to additional SmartWire-DT nodes. Powerfeed modules are also used to create zone control or groups of devices controlled by a single Emergency Stop.

#### Digital and Analog I/O Modules

Digital and analog I/O modules are connected as nodes on the SmartWire-DT network and allow standard or generic devices to be connected to the SmartWire-DT system. They can be connected anywhere along the flat cable network and can therefore be positioned in the control panel to help reduce the I/O wiring.

### Contents

#### Description

	<i>Page</i>
System Components	
Product Selection .....	<b>V7-T9-7</b>
Accessories .....	<b>V7-T9-8</b>
System Controllers .....	<b>V7-T9-11</b>
Contactor Modules .....	<b>V7-T9-12</b>
Pilot Device Modules .....	<b>V7-T9-15</b>
Technical Data and Specifications .....	<b>V7-T9-20</b>
Dimensions .....	<b>V7-T9-34</b>

#### Contactor Modules

Contactor modules fit into standard XT contactors and control relays directly on top, in place of a top mounted auxiliary contact block. The modules fit all XTCE size B and C frame contactors and XTRE control relays.

#### Pilot Device Modules

Pilot device modules fit into standard M22 pilot devices in both front mount and base mount configurations. Single and double contact modules with and without LEDs are available to meet a wide variety of control circuit requirements.

#### Flat and Round Cables

The flat cable is an 8 AWG 24 conductor cable that is flexible, durable, and rated for 600V so that it can be placed in the panel wiring duct along with 480V or 600V power conductors. It has two prominent features: (a) arrows indicating the front of the cable and the direction away from the gateway and (b) black edging indicating the polarity of the flat cable, the 15 Vdc wire and the reference mark for installing the device plugs and flat plugs.

The round cable has 4 AWG 20 and 4 AWG 24 wires and is 300V rated. It is used outside the control panel to connect peripherals such as pushbutton control stations to the SmartWire-DT network. Cable adapters are available to transition a flat cable to a round cable connection and IP67 type connectors are available to provide quick-disconnect cable connections on the round cable.

#### Other System Accessories

Other accessories for the SmartWire-DT system include connectors, jumpers, bushings, plugs, and sockets, flat to round cable adapters and crimping tools.

### Product Selection

#### Gateway Module



#### Gateway Modules

Gateway modules connect the SmartWire-DT system to the programmable logic controller (PLC). They are connected as nodes to the existing PLC fieldbus and are the start of the SmartWire-DT connection system.

Description	Pkg. Qty.	Catalog Number
<b>Ethernet Gateway</b> Connection to EtherNet/IP or Modbus TCP Automatic baud rate detection 10/100 Mbps Address set with DIP switch or DHCP Two RJ45 sockets Connection of up to 99 SmartWire-DT nodes	1	<b>EU5C-SWD-EIP-MODTCP</b>
<b>PROFIBUS-DP Gateway</b> Automatic baud rate detection from 9.6 Kbps to 12 Mbps Address range 1–126 9-pole SUB-D socket Connection of up to 58 SmartWire-DT nodes	1	<b>EU5C-SWD-DP</b>
<b>CANopen Gateway</b> Automatic baud rate detection from 10 Kbps to 1 Mbps Address range 1–32 9-pole SUB-D socket Connection of up to 99 SmartWire-DT nodes	1	<b>EU5C-SWD-CAN</b>

#### Powerfeed Module



#### Powerfeed Modules

Powerfeed modules feed auxiliary 24 Vdc power and/or 15 Vdc network power into the SmartWire-DT flat cable. The auxiliary 24 Vdc power is needed for the power supply of contactors and the 15 Vdc network power is used for supplying power to additional SmartWire-DT nodes. Powerfeed modules are also used to create zone control or groups of devices controlled by a single Emergency Stop.

Description	Pkg. Qty.	Catalog Number
Powerfeed module 1 (for 24 Vdc auxiliary power)	1	<b>EU5C-SWD-PF1-1</b>
Powerfeed module 2 (for 24 Vdc auxiliary power and 15 Vdc network power)	1	<b>EU5C-SWD-PF2-1</b>

#### Digital I/O Module



#### Digital I/O Modules

Digital input/output (I/O) modules are connected as nodes on the SmartWire-DT network and allow standard or generic devices to be connected to the SmartWire-DT system. They can be connected anywhere along the flat cable network and can therefore be positioned in the control panel to help reduce the I/O wiring.

Description	Pkg. Qty.	Catalog Number
Digital module with 8 digital inputs 24 Vdc	1	<b>EU5E-SWD-8DX</b>
Digital module with 4 digital inputs 24 Vdc three-wire connections	1	<b>EU5E-SWD-4DX</b>
Digital module with 8 digital outputs 24 Vdc 10.5A	1	<b>EU5E-SWD-X8D</b>
Digital module with 4 digital inputs 24 Vdc and 4 transistor outputs 24 Vdc/0.5A	1	<b>EU5E-SWD-4D4D</b>
Digital module with 4 digital inputs 24 Vdc and 2 relay outputs 250 Vac	1	<b>EU5E-SWD-4D2R</b>

#### Analog I/O Module



#### Analog I/O Modules

Analog input/output (I/O) modules are connected as nodes on the SmartWire-DT network and allow standard or generic devices to be connected to the SmartWire-DT system. They can be connected anywhere along the flat cable network and can therefore be positioned in the control panel to help reduce the I/O wiring.





Description	Pkg. Qty.	Catalog Number
Analog module with 4 analog inputs 0–10V or 0–20 mA	1	<b>EU5E-SWD-4AX</b>
Analog module with 2 analog inputs 0–10V or 0–20 mA and 2 analog outputs 0–10V or 0–20 mA	1	<b>EU5E-SWD-2A2A</b>
RTD module with 4 temperature inputs PT100, PT1000 or Ni1000	1	<b>EU5E-SWD-4PT</b>



#### Accessories



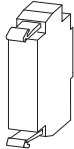
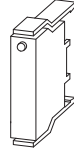
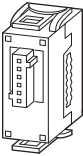

##### System Accessories

Accessories for the SmartWire-DT system includes cables, connectors, jumpers, bushings, plugs, sockets, flat to round cable adapters, and crimping tools.

	Description	Length	Pkg. Qty.	Catalog Number
<b>Flat Cable, 8 AWG 24, 600V</b>				
<b>Flat Cable</b> 	For SmartWire-DT network <b>inside</b> the control panel	328.1 ft (100m)	1	<b>SWD4-100LF8-24</b>
	Complete with flat plugs SWD4-8MF2 installed at both ends	9.8 ft (3m)	1	<b>SWD4-3LF8-24-2S</b>
		16.4 ft (5m)	1	<b>SWD4-5LF8-24-2S</b>
		32.8 ft (10m)	1	<b>SWD4-10LF8-24-2S</b>
<b>Round Cable, 4 AWG 20 and 4 AWG 24, 300V</b>				
<b>Round Cable</b> 	For SmartWire-DT network <b>outside</b> of the control panel	164.0 ft (50m)	1	<b>SWD4-50LR8-24</b>
<b>Universal (Placeholder) Modules</b>				
<b>Universal—Front</b> 	Front mount		20	<b>M22-SWD-NOP</b>
<b>Universal—Base</b> 	Base mount		20	<b>M22-SWD-NOPC</b>
<b>Device Plugs</b>				
<b>Device Plug</b> 	For connection to SmartWire-DT modules or nodes	—	10	<b>SWD4-8SF2-5</b>
<b>Flat Plugs</b>				
<b>Flat Plug</b> 	For connection to SmartWire-DT system components: gateways, powerfeed modules, coupling and terminating resistor	—	10	<b>SWD4-8MF2</b>

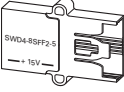
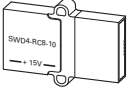

System Accessories, continued

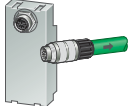
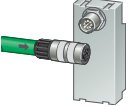
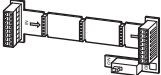
	Description	Pkg. Qty.	Catalog Number
<b>Device Plug Jumpers</b>			
<b>Device Plug Jumper</b>	For bridging open, spare or inverted device plugs	5	SWD4-SEL8-10
			
<b>Control Station PCB Jumpers</b>			
<b>PCB Jumper</b>	For bridging open mounting locations on the control station printed circuit board	5	M22-SWD-SEL8-10
			
<b>Coupling</b>			
<b>Coupling</b>	For connecting or joining flat cables with flat plugs	1	SWD4-8SFF2-5
			
<b>Terminating Resistor</b>			
<b>Terminating Resistor</b>	For terminating the end of the network on a flat cable	1	SWD4-RC8-10
			
<b>Panel Cable Adapter</b>			
<b>Adapter</b>	For flat cable (plug) to round cable terminals	1	SWD4-8FRF-10
			
<b>Cabinet Cable Adapter Socket</b>			
<b>Adapter Socket</b>	For flat cable (plug) to round cable (plug)	1	SWD4-SFL8-20
			
<b>Cabinet Cable Adapter Plug</b>			
<b>Adapter Plug</b>	For flat cable (plug) to round cable (socket)	1	SWD4-SML8-20
			
<b>PCBs</b>			
<b>PCB</b>	For surface mounting M22 enclosures and for base-mount pilot device modules Includes a built-in switchable terminating resistor		
			
	Element enclosure PCB 1	1	M22-SWD-I1-LP01
	Element enclosure PCB 2	1	M22-SWD-I2-LP01
	Element enclosure PCB 3	1	M22-SWD-I3-LP01
	Element enclosure PCB 4	1	M22-SWD-I4-LP01
	Element enclosure PCB 6	1	M22-SWD-I6-LP01

#### System Accessories, continued

	Description	Pkg. Qty.	Catalog Number
<b>Connectors for Round Cables</b>			
<b>Connector Socket</b> 	Round cable 8-pole socket	1	<b>SWD4-SF8-67</b>
<b>Connector Plug</b> 	Round cable 8-pole plug	1	<b>SWD4-SM8-67</b>
<b>Connector (Right Angle)</b> 	Right angle round cable 8-pole socket	1	<b>SWD4-SF8-67W</b>
	Right angle round cable 8-pole plug	1	<b>SWD4-SM8-67W</b>
<b>Enclosure Bushings</b>			
<b>Bushing Socket</b> 	Enclosure bushing, 8-pole socket, M20	1	<b>SWD4-SF8-20</b>
<b>Bushing Plug</b> 	Enclosure bushing, 8-pole plug, M20	1	<b>SWD4-SM8-20</b>
<b>Cord Grip</b>			
<b>Cord Grip</b> 	Round cable cord grip, M20	1	<b>V-M20</b>
<b>Crimping Tool</b>			
<b>Device Plug Tool</b> 	Device plug crimping tool	1	<b>SWD4-CRP-1</b>
<b>Flat Plug Tool</b> 	Flat plug crimping tool	1	<b>SWD4-CRP-2</b>

### System Controllers



### Contents

<b>Description</b>	<b>Page</b>
System Components .....	<b>V7-T9-6</b>
System Controllers	
Contactor Modules .....	<b>V7-T9-12</b>
Pilot Device Modules .....	<b>V7-T9-15</b>
Technical Data and Specifications .....	<b>V7-T9-20</b>
Dimensions .....	<b>V7-T9-34</b>

## System Controllers

### XV Series HMI-PLC with SmartWire-DT

#### Product Description

The XV HMI-PLC controller with SmartWire-DT™ master is a powerful combination of logic, visualization and connectivity to motor control devices. It is ideal for small to mid-range PLC applications where integrated logic and visualization is advantageous and/or where remote administration is critical. The SmartWire-DT master can accept 99 nodes on a 2000 foot-long network.

#### Features

- Built-in SmartWire-DT master for 99 nodes
- Brilliant image display with 65,536 colors
- High resolution resistive touch TFT displays
- 3.5 in, 5.7 in or 7 in widescreen displays in robust plastic housings and bezels, or
- 5.7 in, 8.4 in or 10.4 in displays in high-end aluminum front bezels and metal housings
- Ethernet and RS485 serial ports on all models
- PROFIBUS-DP or CANopen master on all models larger than 3.5 in
- Programmable with IEC 61131-3 compliant XSoft-CoDeSys software
- Easy connection direct to motor control components or I/O modules on SmartWire-DT flat cable

#### Standards and Certifications

- CE
- UL
- cUL
- RoHS



**Note:** For product selection of XV Series HMI-PLCs with SmartWire-DT, see Tab 4 in this volume.

#### Contactorm Modules



#### Contactorm Modules

##### Product Description

Contactorm modules fit onto standard XT contactors and control relays directly on top, in place of a top mounted auxiliary contact block. The modules fit all XTCE size B and C frame contactors and XTRE control relays.

These modules facilitate direct connection to the SmartWire-DT flat cable and eliminate the traditional point-to-point wiring to the PLC input and output modules as well as wiring to the contactorm coils.

##### Features

- Integrated 24 Vdc coil power on network and plug-in modules
- Integrated switch position polling
- Integrated mechanical switch position display
- Integrated feedback circuit to PLC
- Built-in diagnostic bi-color LEDs on each module
- Connection to SmartWire-DT flat cable via quick disconnect device plugs

#### Contents

<i>Description</i>	<i>Page</i>
System Components .....	<b>V7-T9-6</b>
System Controllers .....	<b>V7-T9-11</b>
Contactorm Modules	
Product Identification .....	<b>V7-T9-13</b>
Product Selection .....	<b>V7-T9-14</b>
Pilot Device Modules .....	<b>V7-T9-15</b>
Technical Data and Specifications .....	<b>V7-T9-20</b>
Dimensions .....	<b>V7-T9-34</b>

**Product Identification**

**SmartWire-DT Contactor Modules**

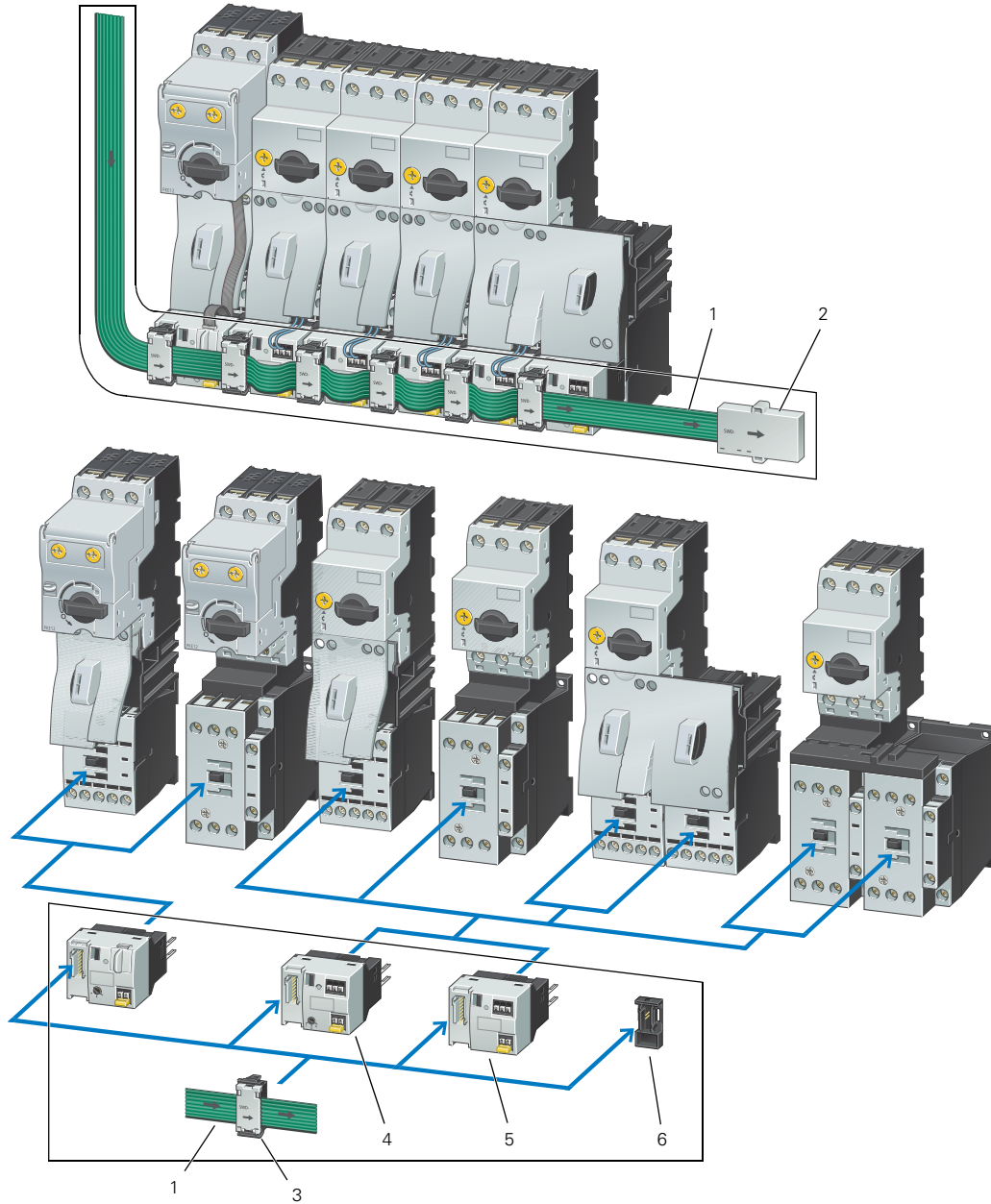

Item Number	Description
1	Flat cable
2	Terminating resistor (SWD4-RC8-10)
3	Device plug (SWD4-85F2-5)
4	Modules for XT contactors with XTPR manual motor protectors, with 1-0-A switch (DIL-SWD-32-002)
5	Modules for XT contactors with XTPR manual motor protectors (DIL-SWD-32-001)
6	Device plug jumper (SWD4-SEL8-10)

#### Product Selection

##### Contactor Modules

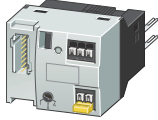
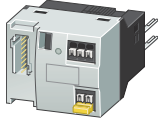

##### Contactor Modules <sup>①②③</sup>

SmartWire-DT module for attachment to XTCE007–XTCE032 contactors and XTRE control relays. One module is required per contactor.

Description	Pkg. Qty.	Catalog Number
Two digital inputs for voltage-free contacts. One electrical interlock for the surface mounting of reversing combinations. Messages: Switch status contactor, status of the digital inputs 1 and 2. Commands: Contactor actuation.	5	DIL-SWD-32-001
Two digital inputs for voltage-free contacts. One electrical interlock for the surface mounting of reversing combinations. 1-0-A switch for manual or automatic operation. Messages: Contactor switching position, status of the digital inputs 1 and 2, 1-0-A switch position. Commands: Contactor actuation.	5	DIL-SWD-32-002

#### 9

##### PKE Contactor Module



##### PKE Contactor Module

SmartWire-DT module for connection of XTPE manual motor controllers. One module is required per contactor and XTPE manual motor protector.

Description	Pkg. Qty.	Catalog Number
Connecting cable between module and XTPE trip block included as standard. One electrical interlock for the surface mounting of reversing starters. 1-0-A switch for manual or automatic operation. Selectable overload relay function for connecting the contactor on overload. Messages: Switch position contactor/PKE/1-0-A switch Motor current in % Thermal motor image in % Trip-indicating auxiliary contact (Overload, Short-circuit,...) Set value of overload releases Set value Verification time (CLASS), Part no. Trip block. Commands: Contactor actuation, activation of overload relay function (ZMR)	4	PKE-SWD-32

##### Design Note

The number of motor starters or XTCE contactors that can be connected is dependent upon the power consumption of the contactor coils. To increase the number of SmartWire-DT modules that can be connected. Powerfeed modules can be used.

24 Vdc		XTCE007	XTCE009	XTCE012	XTCE015	XTCE018	XTCE025	XTCE032
Pick-up power	W	3	3	4.5	4.5	12	12	12
Sealing power	W	3	3	4.5	4.5	0.5	0.5	0.5

##### Notes

- ① Take account of the maximum current consumption of the contactor coils per SmartWire-DT line.
- ② A2 connections must not be linked.
- ③ Connection terminals for electrical interlocking are not suitable for safety technology.

Pilot Device Modules



**Contents**

<i><b>Description</b></i>	<i><b>Page</b></i>
System Components .....	<b>V7-T9-6</b>
System Controllers .....	<b>V7-T9-11</b>
Contactor Modules .....	<b>V7-T9-12</b>
Pilot Device Modules	
Product Identification .....	<b>V7-T9-16</b>
Product Selection .....	<b>V7-T9-18</b>
Technical Data and Specifications .....	<b>V7-T9-20</b>
Dimensions .....	<b>V7-T9-34</b>

**Pilot Device Modules**

**Product Description**

Pilot device modules fit onto standard M22 pilot devices in both front mount and base mount configurations. Single and double contact modules with and without LEDs are available to meet a wide variety of control circuit requirements.

These modules facilitate direct connection to the SmartWire-DT flat cable and eliminate the traditional point-to-point wiring to the PLC input and output modules.

**Features**

- Front or base mount modules
- Built-in diagnostic bi-color LEDs on each module
- Connection to SmartWire-DT flat cable via quick disconnect device plugs



# 9.1

## Connectivity Solutions

### SmartWire-DT Panel Wiring Solution

#### Product Identification

#### Pilot Device Modules Connections

9

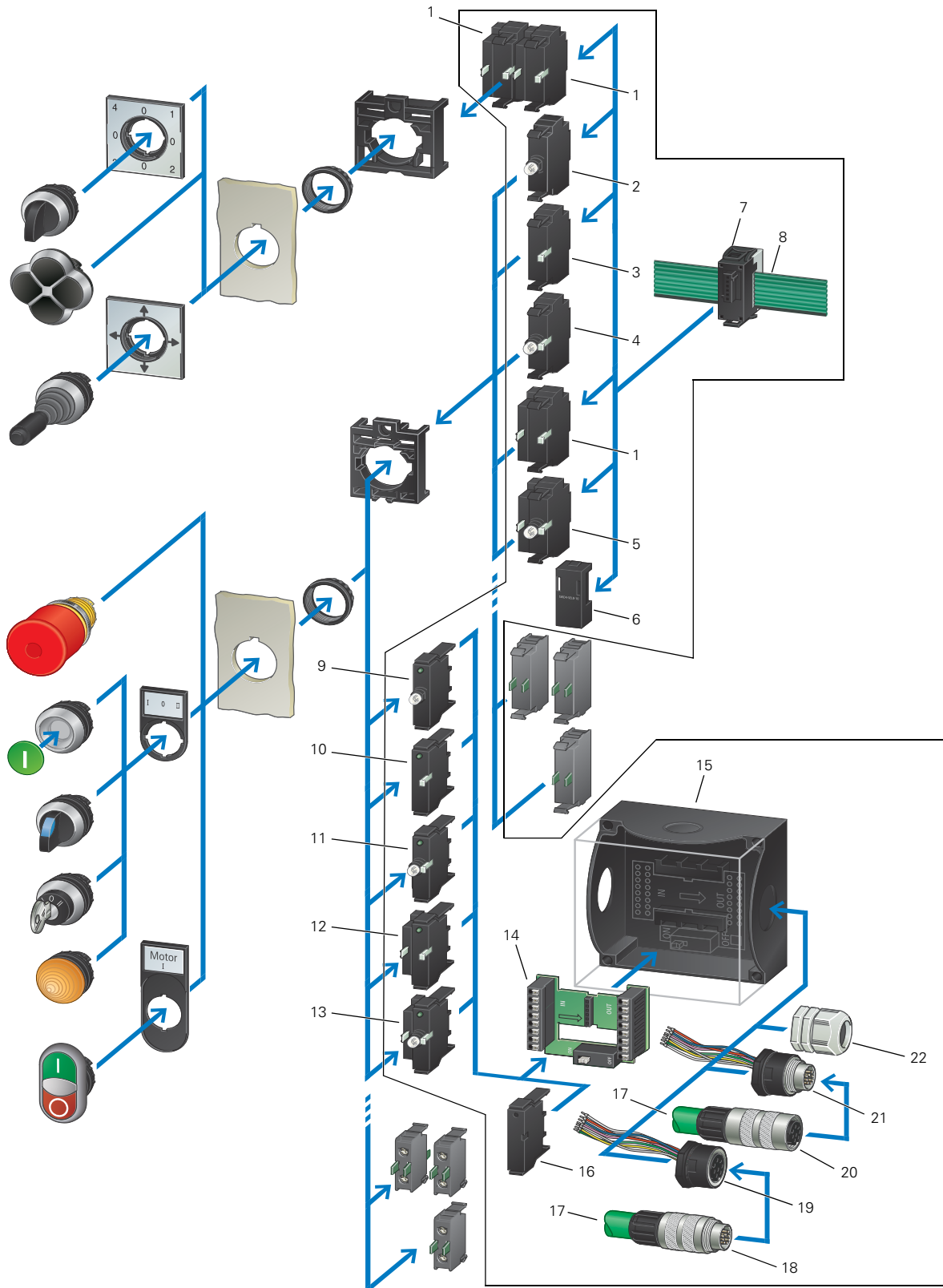







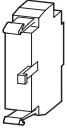

## Pilot Device Modules Connections

Item Number	Description
1	M22 contact module, front mount (M22-SWD-KC22)
2	M22 LED module, front mount (M22-SWD-LED_)
3	Module, front mount (M22-SWD-K11)
4	M22 contact module with LED, front mount (M22-SWD-K11LED_)
5	M22 contact module with LED, front mount (M22-SWD-K22LED_)
6	Device plug jumper (SWD4-SEL8-10)
7	Device plug (SWD4-85F2-5)
8	Flat cable
9	M22 LED module, base mount (M22-SWD-LEDC_)
10	M22 contact module, base mount (M22-SWD-KC11)
11	M22 contact module with LED, base mount (M22-SWD-K11LEDC_)
12	M22 contact module, base mount (M22-SWD-KC22)
13	M22 contact module with LED, base mount (M22-SWD-K22LEDC_)
14	1 element enclosure PCB (M22-SWD-I1-1P01)
15	M22 control station enclosure with M20 knockouts
16	Control station PCB jumper (M22-SWD-SEL8-10)
17	Round cable
18	Round cable plug (SWD4-SM8-67)
19	Enclosure bushing socket (SWD4-SF8-20)
20	Round cable socket (SWD4-SF8-67)
21	Enclosure bushing plug (SWD4-SM8-20)
22	M20 cord grip (V-M20)

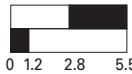
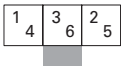
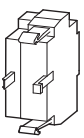

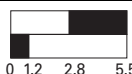
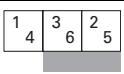
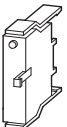

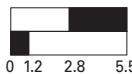
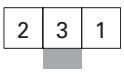
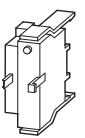

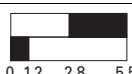
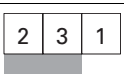

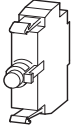

#### Product Selection

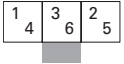
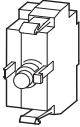
##### M22 Pilot Device Modules Connections

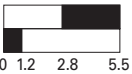

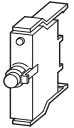
##### M22 Contact Modules, without LEDs

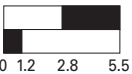
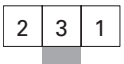
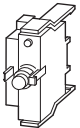
	Number of Changeover Contacts	Contact Sequence	Contact Travel Diagram Stroke in Connection with Front Element	Configuration	Pkg. Qty.	Catalog Number
<b>Front Mount</b>						
 <p><b>M22-SWD-K11</b></p>	1		 <p>0 1.2 2.8 5.5</p>		20	<b>M22-SWD-K11</b>
 <p><b>M22-SWD-K22</b></p>	2		 <p>0 1.2 2.8 5.5</p>		10	<b>M22-SWD-K22</b>
<b>Base Mount</b>						
 <p><b>M22-SWD-KC11</b></p>	1		 <p>0 1.2 2.8 5.5</p>		20	<b>M22-SWD-KC11</b>
 <p><b>M22-SWD-KC22</b></p>	2		 <p>0 1.2 2.8 5.5</p>		10	<b>M22-SWD-KC22</b>

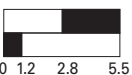
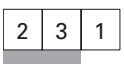
M22 Contact Modules, with LEDs

	Number of Changeover Contacts	Contact Sequence	Contact Travel Diagram Stroke in Connection with Front Element	Configuration	Color LED	Pkg. Qty.	Catalog Number
<b>Front Mount</b>							
	1				○	20	M22-SWD-K11LED-W
					●		M22-SWD-K11LED-B
					●		M22-SWD-K11LED-G
					●		M22-SWD-K11LED-R
	2				○	10	M22-SWD-K22LED-W
					●		M22-SWD-K22LED-B
					●		M22-SWD-K22LED-G
					●		M22-SWD-K22LED-R
<b>Base Mount</b>							
	1				○	20	M22-SWD-K11LEDC-W
					●		M22-SWD-K11LEDC-B
					●		M22-SWD-K11LEDC-G
					●		M22-SWD-K11LEDC-R
	2				○	10	M22-SWD-K22LEDC-W
					●		M22-SWD-K22LEDC-B
					●		M22-SWD-K22LEDC-G
					●		M22-SWD-K22LEDC-R

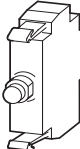
M22 LED Modules

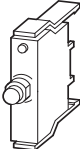
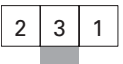
	Configuration	Color LED	Pkg. Qty.	Catalog Number
<b>Front Mount</b>				
		○	20	M22-SWD-LED-W
		●		M22-SWD-LED-B
		●		M22-SWD-LED-G
		●		M22-SWD-LED-R
<b>Base Mount</b>				
		○	20	M22-SWD-LEDC-W
		●		M22-SWD-LEDC-B
		●		M22-SWD-LEDC-G
		●		M22-SWD-LEDC-R

## Technical Data and Specifications

### XV Series HMI-PLCs

Model	XV-102			XV-152		
	3.5 in	5.7 in	7.0 in	5.7 in	8.4 in	10.4 in
Operating system	WinCE 5.0 Professional	WinCE 5.0 Professional	WinCE 5.0 Professional	WinCE 5.0 Professional	WinCE 5.0 Professional	WinCE 5.0 Professional
Touchscreen technology	Resistive	Resistive	Resistive	Resistive	Resistive	Resistive
Display, colors	Color TFT, 64k colors	Color TFT, 64k colors	Color TFT, 64k colors	Color TFT, 64k colors	Color TFT, 64k colors	Color TFT, 64k colors
Pixel resolution (landscape) portrait mode also available	QVGA 320 x 240	VGA 640 x 480	WVGA 800 x 480	VGA 640 x 480	VGA 640 x 480	VGA 640 x 480
Brightness (cd/m <sup>2</sup> )	250	250	250	350	350	350
Backlight	LED, selectable dimming	LED, selectable dimming	LED, selectable dimming	LED, selectable dimming	LED, selectable dimming	LED, selectable dimming
Lifespan of backlight (half-life)	40,000 hrs	40,000 hrs	40,000 hrs	40,000 hrs	40,000 hrs	40,000 hrs
Processor	32 bit RISC, 400 MHz	32 bit RISC, 400 MHz	32 bit RISC, 400 MHz	32 bit RISC, 400 MHz	32 bit RISC, 400 MHz	32 bit RISC, 400 MHz
Volatile memory	64 MB DRAM	64 MB DRAM	64 MB DRAM	64 MB DRAM	64 MB DRAM	64 MB DRAM
Non-volatile memory	125 KB NVRAM/64 MB NAND, 1 SD card slot	125 KB NVRAM/64 MB NAND/ 2 MB NOR, 1 SD card slot		125 KB NVRAM/64 MB NAND/ 2 MB NOR, 1 SD card slot		
Real time clock	Yes	Yes	Yes	Yes	Yes	Yes
Communication ports	Ethernet 10/100, RS-485 or RS-232 USB Device		Ethernet 10/100, RS-485, RS-232 USB Host, USB Device	Ethernet 10/100, RS-485, RS-232 USB Host, USB Device		
Slots for COMMM modules	None	None	None	None	None	None
Power supply rated voltage	24 Vdc nominal (–20%/+25%) with polarity protection			24 Vdc nominal (–20%/+25%) with polarity protection		
Continuous current consumption (max. amps)	0.2	0.4	0.4	0.4	0.6	0.6
Starting current inrush (A <sup>2</sup> s)	1.5	1.5	1.5	1.5	1.5	1.5
Ambient conditions						
Operation—relative humidity, non-condensing	0 to 50°C, 10 to 95%	0 to 50°C, 10 to 95%	0 to 50°C, 10 to 95%	0 to 50°C, 10 to 95%	0 to 50°C, 10 to 95%	0 to 50°C, 10 to 95%
Storage/transport—relative humidity, non-condensing	–20 to 60°C, 10 to 95%	–20 to 60°C, 10 to 95%	–20 to 60°C, 10 to 95%	–20 to 60°C, 10 to 95%	–20 to 60°C, 10 to 95%	–20 to 60°C, 10 to 95%
Shock	IEC 60068-2-27 15g for 11 ms duration			IEC 60068-2-27 15g for 11 ms duration		
Vibration	IEC 60068-2-6 5–9 Hz: 3.5 mm displacement 9–60 Hz: 0.15 mm displacement 60–150 Hz: 2g acceleration			IEC 60068-2-6 5–9 Hz: 3.5 mm displacement 9–60 Hz: 0.15 mm displacement 60–150 Hz: 2g acceleration		
Agency certifications and standards	CE, UL/cUL, CSA (pending), RoHS			CE, UL/cUL, CSA (pending), RoHS		
Protection type						
Front	IP65, NEMA 4X (indoor)	IP65, NEMA 4X (indoor)	IP65, NEMA 4X (indoor)	IP65, NEMA 4X (indoor)	IP65, NEMA 4X (indoor)	IP65, NEMA 4X (indoor)
Rear	IP20, NEMA 1	IP20, NEMA 1	IP20, NEMA 1	IP20, NEMA 1	IP20, NEMA 1	IP20, NEMA 1
Housing material	Plastic	Plastic	Plastic	Metal	Metal	Metal
Dimensions WxHxD (mm)	136 x 100 x 30	170 x 130 x 39	210 x 135 x 38	212 x 156 x 53	275 x 208 x 53	345 x 260 x 54
Mounting cutout WxH (mm)	123 x 87	157 x 117	197 x 122	198 x 142	261 x 194	329 x 238
Approximate weight lbs (kg)	0.7 (0.3)	1.3 (0.6)	1.3 (0.6)	2.9 (1.3)	4.3 (2.1)	6.1 (3.0)
Ability to run third party software	No	No	No	No	No	No
XSoft-CoDeSys-2 development software	SW-XSOFT-CODESYS-2-S (seat) SW-XSOFT-CODESYS-2-M (multi-seat)			SW-XSOFT-CODESYS-2-S (seat) SW-XSOFT-CODESYS-2-M (multi-seat)		

## Gateways and Powerfeed Modules

Description	Unit	EU5C-SWD-EIP-MODTCP Gateway	EU5C-SWD-DP Gateway	EU5C-SWD-CAN Gateway	EU5C-SWD-PF1-1 Powerfeed	EU5C-SWD-PF2-1 Powerfeed
<b>General</b>						
Standards		IEC/EN 61131-2 EN 50178	IEC/EN 61131-2 EN 50178	IEC/EN 61131-2 EN 50178	IEC/EN 61131-2 EN 50178	IEC/EN 61131-2 EN 50178
Dimensions (W x H x D)	in (mm)	1.38 x 3.54 x 4.88 (35 x 90 x 124)	1.38 x 3.54 x 5.0 (35 x 90 x 127)	1.38 x 3.54 x 5.0 (35 x 90 x 127)	1.38 x 3.54 x 4.88 (35 x 90 x 124)	1.38 x 3.54 x 4.88 (35 x 90 x 124)
Weight	lbs (kg)	0.37 (0.17)	0.35 (0.16)	0.35 (0.16)	0.24 (0.11)	0.37 (0.17)
Mounting		Top-hat rail IEC/EN 60715, 35 mm		DIN rail IEC/EN 60715, 35 mm		
Mounting position		Vertical	Vertical	Vertical	Vertical	Vertical
<b>Ambient Conditions, Mechanical</b>						
Degree of protection (IEC/EN 60529)		IP20	IP20	IP20	IP20	IP20
Vibrations (IEC/EN 61131-2:2008)						
Constant amplitude 3.5 mm	Hz	5–8.4	5–8.4	5–8.4	5–8.4	5–8.4
Constant acceleration 1g	Hz	8.4–150	8.4–150	8.4–150	8.4–150	8.4–150
Mechanical shock resistance (IEC/EN 60068-2-27) semi-sinusoidal 15g/11 ms	Impacts	9	9	9	9	9
Drop to IEC/EN 60068-2-31 (drop height)	in (mm)	1.97 (50)	1.97 (50)	1.97 (50)	1.97 (50)	1.97 (50)
Free fall, packaged (IEC/EN 60068-2-32)	ft (m)	1.0 (0.3)	1.0 (0.3)	1.0 (0.3)	1.0 (0.3)	1.0 (0.3)
<b>Electromagnetic Compatibility (EMC)</b>						
Overvoltage category		II	II	II	II	II
Pollution degree		2	2	2	2	2
Electrostatic discharge (IEC/EN 61131-2:2008)						
Air discharge (Level 3)	kV	8	8	8	8	8
Contact discharge (Level 2)	kV	4	4	4	4	4
Electromagnetic fields (IEC/EN 61131-2:2008)						
80–1000 MHz	V/m	10	10	10	10	10
1.4–2 GHz	V/m	3	3	3	3	3
2–2.7 GHz	V/m	1	1	1	1	1
Radio interference suppression (SmartWire-DT)		EN 55011 Class A				
Burst (IEC/EN 61131-2:2008, Level 3)						
Supply cables	kV	2	2	2	2	2
CAN/DP bus cable	kV	1	1	1	—	—
SmartWire-DT cables	kV	1	1	1	1	1
Surge (IEC/EN 61131-2:2008, Level 1)						
Supply cables	kV	0.5	0.5	0.5	0.5	0.5
CAN/DP bus cable	kV	1	1	1	1	1
Radiated RFI (IEC/EN 61131-2:2008, Level 3)	V	10	10	10	10	10
<b>Climatic Environmental Conditions</b>						
Operating ambient temperature (IEC 60068-2)	°F (°C)	–13° to 131° (–25° to 55°)				
Condensation		Prevent with suitable measures				
Storage	°F (°C)	–40° to 158° (–40° to 70°)				
Relative humidity, non-condensing (IEC/EN 60068-2-30)	%	5–95	5–95	5–95	5–95	5–95
<b>Supply Voltage U<sub>Aux</sub></b>						
SM Puffer Bremer	V	24 Vdc (–15%/+20%)				
Residual ripple on the input voltage	%	≤5	5	5	5	5
Protection against polarity reversal		Yes	Yes	Yes	Yes	Yes
Max. current (I <sub>max</sub> )	A	3 <sup>①</sup>	3 <sup>①</sup>	3 <sup>①</sup>	3	3
Short-circuit rating		No, external fuse FAZ Z3				
Power loss	W	Normally 1	Normally 1	Normally 1	Normally 1	Normally 1
Potential isolation		No	No	No	No	No
Rated operating voltage of 24 Vdc modes	V	Typ. U <sub>Aux</sub> –0.2	Typ. U <sub>Aux</sub> –0.2	Typ. U <sub>Aux</sub> –0.2	Typ. U <sub>Aux</sub> –0.2	Typ. U <sub>Aux</sub> –0.2

**Note**

① If contactors with a total current consumption >3A are connected, a powerfeed module EU5C-SWD-PF1/2 has to be used.

## Gateways and Powerfeed Modules, continued

Description	Unit	EU5C-SWD-EIP-MODTCP Gateway	EU5C-SWD-DP Gateway	EU5C-SWD-CAN Gateway	EU5C-SWD-PF1-1 Powerfeed	EU5C-SWD-PF2-1 Powerfeed
<b>Supply Voltage U<sub>Pow</sub></b>						
Supply voltage	V	24 Vdc (–15%/+20%)				
Input voltage ripple	%	≤5	≤5	≤5	≤5	≤5
Siemens MPL, (optional)		Yes	Yes	Yes	—	Yes
Rated current (I)	A	0.7	0.7	0.7	0.7	0.7
Overload proof		Yes	Yes	Yes	Yes	Yes
Inrush current and duration	A	12.5 A/6 ms	12.5 A/6 ms	12.5 A/6 ms	12.5 A/6 ms	12.5 A/6 ms
Heat dissipation at 24 Vdc	W	3.8	3.8	3.8	3.8	3.8
Potential isolation between U <sub>Pow</sub> and 15V SmartWire-DT supply voltage		No	No	No	—	Yes
Bridging voltage dips	ms	10	10	10	—	10
Repetition rate	s	1	1	1	—	1
Status indication (LED)		Yes	Yes	Yes	No	Yes
<b>SmartWire-DT Supply Voltage</b>						
Rated operating voltage (U <sub>o</sub> )	V	14.5 ±3%	14.5 ±3%	14.5 ±3%	14.5 ±3%	14.5 ±3%
Max. current (I <sub>max</sub> )	A	0.7 ①	0.7 ①	0.7 ①	0.7	0.7
Short-circuit proof		Yes	Yes	Yes	No	Yes
<b>Connection Supply Voltages</b>						
Connection type		Push in terminals	Push in terminals	Push in terminals	Push in terminals	Push in terminals
Solid	mm <sup>2</sup>	0.2–1.5 (AWG 24–16)	0.2–1.5 (AWG 24–16)	0.2–1.5 (AWG 24–16)	0.2–1.5 (AWG 24–16)	0.2–1.5 (AWG 24–16)
Flexible with ferrule	mm <sup>2</sup>	0.25–1.5	0.25–1.5	0.25–1.5	0.25–1.5	0.25–1.5
<b>SmartWire-DT Network</b>						
Station type		SmartWire-DT master	SmartWire-DT master	SmartWire-DT master	—	—
Number of SmartWire-DT modes		99	58	99	—	—
Baud rates		125 250	125	125	—	—
Address allocation		Automatic	Automatic	Automatic	None	None
Status indication (LED)						
SmartWire-DT master		Green	Green	Green	Green	Green
Configurations		Red	Red	Red	Red	Red
Connections		Plug, 8-pole	Plug, 8-pole	Plug, 8-pole	2 x plug, 8-pole	2 x plug, 8-pole
Plug connectors		Blade terminal SWD4-8MF2	Flat plug SWD4-8MF2	Flat plug SWD4-8MF2	Two flat plugs SWD4-8MF2	Two flat plugs SWD4-8MF2
<b>Fieldbus Interface</b>						
Bus protocol		Ethernet IP/Modbus TCP slave	PROFIBUS-DP	CANopen	—	—
Baud rates		10/100 mB	Up to 12 mB	To 1 mB	—	—
Address allocation		Automatic	Automatic	Automatic	—	—
Station address		—	2–125	2–32	—	—
Address allocation		DIP switch/DHCP/BOOTP selection via DIP switch	DIP switch	DIP switch	—	—
Status display fieldbus interface (LED)		Link status: yellow (10 mB), green (100 mB) flashing	Two-colored red/green	Two-colored red/green	—	—
Terminating resistor		—	Switchable via plug	DIP switches	—	—
Connection design for field bus		2 x RJ45 (2-channel switch)	1 x SUB-D socket, 9-pole	1 x SUB-D plug, 9-pole	—	—
Potential isolation		Yes	Yes	Yes	—	—

**Note**

① If contactors with a total current consumption >0.7 A are connected, a Power Feeder module EU5C-SWD-PF2 has to be used.



## Input/Output Modules

Description	Unit	EU5E-SWD-8DX	EU5E-SWD-4DX	EU5E-SWD-4D4D	EU5E-SWD-4D2R	EU5E-SWD-X8D
<b>General</b>						
Standards		IEC/EN 61131-2; EN 50178				
Dimensions (W x H x D)	in (mm)	1.38 x 3.54 x 3.97 (35 x 90 x 101)	1.38 x 3.54 x 3.97 (35 x 90 x 101)	1.38 x 3.54 x 3.97 (35 x 90 x 101)	1.38 x 3.54 x 3.97 (35 x 90 x 101)	1.38 x 3.54 x 3.97 (35 x 90 x 101)
Weight	lbs (kg)	0.22 (0.10)	0.22 (0.10)	0.22 (0.10)	0.22 (0.10)	0.22 (0.10)
Mounting		DIN rail IEC/EN 60715, 35 mm	Top-hat rail IEC/ EN 60715, 35 mm	DIN rail IEC/EN 60715, 35 mm	DIN rail IEC/EN 60715, 35 mm	Top-hat rail IEC/ EN 60715, 35 mm
Mounting position		Vertical	Vertical	Vertical	Vertical	Vertical
<b>Ambient Conditions, Mechanical</b>						
Degree of protection (IEC/EN 60529)		IP20	IP20	IP20	IP20	IP20
Vibrations (IEC/EN 61131-2:2008)						
Constant amplitude 3.5 mm	Hz	5–8.4	5–8.4	5–8.4	5–8.4	5–8.4
Constant acceleration 1g	Hz	8.4–150	8.4–150	8.4–150	8.4–150	8.4–150
Mechanical shock resistance (IEC/EN 60068-2-27) semi-sinusoidal 15g/11 ms	Impacts	9	9	9	9	9
Drop to IEC/EN 60068-2-31 (drop height)	in (mm)	1.97 (50)	1.97 (50)	1.97 (50)	1.97 (50)	1.97 (50)
Free fall, packaged (IEC/EN 60068-2-32)	ft (m)	1.0 (0.3)	1.0 (0.3)	1.0 (0.3)	1.0 (0.3)	1.0 (0.3)
<b>Electromagnetic Compatibility (EMC)</b>						
Overvoltage category		II	II	II	II	II
Pollution degree		2	2	2	2	2
Electrostatic discharge (IEC/EN 61131-2:2008)						
Air discharge (Level 3)	kV	8	8	8	8	8
Contact discharge (Level 2)	kV	4	4	4	4	4
Electromagnetic fields (IEC/EN 61131-2:2008)						
80–1000 MHz	V/m	10	10	10	10	10
1.4–2 GHz	V/m	3	3	3	3	3
2–2.7 GHz	V/m	1	1	1	1	1
Radio interference suppression (SmartWire-DT)		EN 55011 Class A	EN 55011 Class A	EN 55011 Class A	EN 55011 Class A	EN 55011 Class A
Burst (IEC/EN 61131-2:2008, Level 3)						
Supply cables	kV	2	2	2	2	2
Signal lines	kV	1	1	1	1	1
SmartWire-DT cables	kV	1	1	1	1	1
Surge (IEC/EN 61131-2:2008, Level 1)						
Supply cables	kV	0.5	0.5	0.5	0.5	0.5
Radiated RFI (IEC/EN 61131-2:2008, Level 3)	V	10	10	10	10	10
<b>Climatic Environmental Conditions</b>						
Operating ambient temperature (IEC 60068-2)	°F (°C)	–13° to 131° (–25° to 55°)				
Condensation		Prevent with suitable measures				
Storage	°F (°C)	–40° to 158° (–40° to 70°)				
Relative humidity, non-condensing (IEC/ EN 60068-2-30)	%	5–95	5–95	5–95	5–95	5–95
<b>SmartWire-DT Network</b>						
Station type		SmartWire-DT (node)	SmartWire-DT (slave)	SmartWire-DT (node)	SmartWire-DT (node)	SmartWire-DT (slave)
Address allocation		Automatic	Automatic	Automatic	Automatic	Automatic
SmartWire-DT status (LED)		Green	Green	Green	Green	Green
Connection						
Plug		8-pole	Plug, 8-pole	8-pole	8-pole	Plug, 8-pole
Connection plug		External device plug SWD4-8SF2-5				
Current consumption (15V SWD supply)		See <a href="#">Page V7-T9-33</a>	See <a href="#">Page V7-T9-33</a>	See <a href="#">Page V7-T9-33</a>	See <a href="#">Page V7-T9-33</a>	See <a href="#">Page V7-T9-33</a>

**Note**

⊙ Minimum length 8 mm.

## Input/Output Modules, continued

Description	Unit	EU5E-SWD-8DX	EU5E-SWD-4DX	EU5E-SWD-4D4D	EU5E-SWD-4D2R	EU5E-SWD-X8D
<b>Connection Supply and I/O</b>						
Connection type		Push in terminals	Push in terminals	Push in terminals	Push in terminals	Push in terminals
Solid	mm <sup>2</sup>	0.2–1.5 (AWG 24–16)	0.2–1.5 (AWG 24–16)	0.2–1.5 (AWG 24–16)	0.2–1.5 (AWG 24–16)	0.2–1.5 (AWG 24–16)
Flexible with ferrule <sup>①</sup>	mm <sup>2</sup>	0.25–1.5 (AWG 24–16)	0.25–1.5	0.25–1.5	0.25–1.5	0.25–1.5 (AWG 24–16)
<b>24 Vdc Supply for Output Supply</b>						
Rated operational voltage ( $U_e$ )	V	24 Vdc (–15%/+20%)	24 Vdc (–15%/+20%)	24 Vdc (–15%/+20%)	24 Vdc (–15%/+20%)	24 Vdc (–15%/+20%)
Residual ripple on the input voltage	%	—	≤5	5	—	≤5
Protection against polarity reversal		—	Yes	Yes	—	Yes
<b>Digital Inputs</b>						
Quantity		8	4 <sup>①</sup>	4	4	—
Input current	mA	Typ. 4 at 24 Vdc	Typ. 4 at 24 Vdc	Typ. 4 at 24 Vdc	Typ. 4 at 24 Vdc	Typ. 4 at 24 Vdc
Voltage level to IEC/EN 61131-2						
Limit value type 1		Low <5 Vdc; High >15 Vdc				
Input delay						
High		<0.2 ms	<0.2 ms	<0.2 ms	<0.2 ms	<0.2 ms
Low		<0.2 ms	<0.2 ms	<0.2 ms	<0.2 ms	<0.2 ms
SmartWire-DT status (LED)		Yellow	Yellow	Yellow	Yellow	—
<b>Power Supply I+, I-</b>						
Overload proof		—	Yes, with diagnostics	—	—	—
Output current per input supply	A	—	≤0.5	—	—	—
Supply voltage	V	—	$U_e$ 0.16V	—	—	—
<b>Transistor Outputs</b>						
Number		—	—	4	—	8
Output current	A	—	—	Normally 0.5 at 24 Vdc	—	Normally 0.5 at 24 Vdc
Short-circuit tripping current	A	—	—	Max. 1.2 over 3 ms	—	Max. 1.2 over 3 ms
Lamp load ( $R_{LL}$ )	W	—	—	3	—	≤3
Overload proof		—	—	Yes, with diagnostics	—	Yes, with diagnostics
Switching capacity		—	—	EN 60947-5-1 utilization category DC-13	—	EN 60947-5-1 utilization category DC-13
Status display	LED	—	—	—	—	Yellow
<b>Relay Outputs</b>						
Number		—	—	—	2	—
Contact type art		—	—	—	N/O contact	—
Operations						
Utilization category AC-1, 250V, 6A		—	—	—	>6 x 10 <sup>4</sup>	—
Utilization category AC-15, 250V, 3A		—	—	—	>5 x 10 <sup>4</sup>	—
Utilization category DC-13, 24V, 1A		—	—	—	>2 x 10 <sup>5</sup>	—
Safe isolation	Vac	—	—	—	230	—
Minimum load current	mA	—	—	—	100 mA, 12 Vdc	—
Pick-up/drop-out time	ms	—	—	—	5/2.5	—
Bounce duration	ms	—	—	—	Normally 1.5	—
Short-circuit protection		—	—	—	External 4A gL/gG	—
Status display outputs (LED)		—	—	Yellow	Yellow	—
<b>Potential Isolation</b>						
Inputs for SmartWire-DT		Yes	Yes	Yes	Yes	Yes
Transistor outputs for SmartWire-DT		—	Yes	Yes	—	—
Transistor outputs for inputs		—	—	No	—	—
Relays for SmartWire-DT		—	—	—	Yes	—
Relays for inputs		—	—	—	Yes	—
Relays for relays		—	—	—	Yes	—

**Note**

<sup>①</sup> Three-wire connection with power supply I+, I-.

## Analog I/O Modules

Description	Unit	EU5E-SWD-4AX	EU5E-SWD-2A2A	EU5E-SWD-4PT
<b>General</b>				
Standards		IEC/EN 61131-2/EN 50178	IEC/EN 61131-2/EN 50178	IEC/EN 61131-2/EN 50178
Dimensions (W x H x D)	in (mm)	1.38 x 3.54 x 3.97 (35 x 90 x 101)	1.38 x 3.54 x 3.97 (35 x 90 x 101)	1.38 x 3.54 x 3.97 (35 x 90 x 101)
Weight	lbs (kg)	0.22 (0.10)	0.22 (0.10)	0.22 (0.10)
Mounting		Top-hat rail IEC/EN 60715, 35 mm	Top-hat rail IEC/EN 60715, 35 mm	Top-hat rail IEC/EN 60715, 35 mm
Mounting position		Vertical	Vertical	Vertical
<b>Ambient Conditions, Mechanical</b>				
Protection type (IEC/EN 60529)		IP20	IP20	IP20
Vibrations (IEC/EN 61131-2:2008)				
Constant amplitude 3.5 mm	Hz	5–8.4	5–8.4	5–8.4
Constant acceleration 1g	Hz	8.4–150	8.4–150	8.4–150
Mechanical shock resistance (IEC/EN 60068-2-27) semi-sinusoidal 15g/11 ms				
Drop to IEC/EN 60068-2-31 (drop height)	in (mm)	1.97 (50)	1.97 (50)	1.97 (50)
Free fall, packaged (IEC/EN 60068-2-32)	ft (m)	1.0 (0.3)	1.0 (0.3)	1.0 (0.3)
<b>Electromagnetic Compatibility (EMC)</b>				
Overvoltage category				
		II	II	II
Pollution degree				
		2	2	2
Electrostatic discharge (IEC/EN 61131-2:2008)				
Air discharge (Level 3)				
	kV	8	8	8
Contact discharge (Level 2)				
	kV	4	4	4
Electromagnetic fields (IEC/EN 61131-2:2008)				
80–1000 MHz				
	V/m	10	10	10
1.4–2 GHz				
	V/m	3	3	3
2–2.7 GHz				
	V/m	1	1	1
Radio interference suppression (SmartWire-DT)				
		EN 55011 Class A	EN 55011 Class A	EN 55011 Class A
Burst (IEC/EN 61131-2:2008, Level 3)				
Supply cables				
	kV	2	2	2
Signal lines				
	kV	2	2	2
SmartWire-DT cables				
	kV	2	2	2
Surge (IEC/EN 61131-2:2008, Level 1)				
		Supply cables 1.0 kV	Supply cables 1.0 kV	Supply cables 1.0 kV
Radiated RFI (IEC/EN 61131-2:2008, Level 3)				
	V	10	10	10
<b>Climatic Environmental Conditions</b>				
Operating ambient temperature (IEC 60068-2)				
	°F (°C)	13° to 131° (–25° to 55°)	13° to 131° (–25° to 55°)	13° to 131° (–25° to 55°)
Condensation				
		Prevent with suitable measures	Prevent with suitable measures	Prevent with suitable measures
Storage				
	°F (°C)	–40° to 158° (–40° to 70°)	–40° to 158° (–40° to 70°)	–40° to 158° (–40° to 70°)
Relative humidity, non-condensing (IEC/EN 60068-2-30)				
	%	5–95	5–95	5–95
<b>SmartWire-DT Network</b>				
Station type				
		SmartWire-DT slave	SmartWire-DT slave	SmartWire-DT slave
Baud rate setting				
		Automatic	Automatic	Automatic
SmartWire-DT status LED				
	LED	Green	Green	Green
Connection				
		Plug: 8-pole/Connection plug: External device plug SWD4-8SF2-5		
Current consumption (15V SWD supply)				
		See <a href="#">Page V7-T9-33</a>	See <a href="#">Page V7-T9-33</a>	See <a href="#">Page V7-T9-33</a>
<b>Connection Supply and I/O</b>				
Connection type				
		Push in terminals	Push in terminals	Push in terminals
Solid				
	mm <sup>2</sup>	0.25–1.5 (AWG 24–16)	0.25–1.5 (AWG 24–16)	0.25–1.5 (AWG 24–16)
Flexible with ferrule <sup>①</sup>				
	mm <sup>2</sup>	0.25–1.5 (AWG 24–16)	0.25–1.5 (AWG 24–16)	0.25–1.5 (AWG 24–16)
<b>24 Vdc Supply for Output Supply</b>				
Rated operational voltage (U <sub>e</sub> )				
	V	24 Vdc –15%/+20%	24 Vdc –15%/+20%	24 Vdc –15%/+20%
Residual ripple on the input voltage				
	%	≤5	≤5	≤5
Current consumption				
	mA	10	50	—
Protection against polarity reversal				
		Yes	Yes	Yes

**Note**

<sup>①</sup> Minimum length 8 mm.

## Analog I/O Modules, continued

Description	Unit	EU5E-SWD-4AX	EU5E-SWD-2A2A	EU5E-SWD-4PT
<b>Analog Inputs</b>				
Quantity		Four (two-wire connection, screened, length <10m)	Two (two-wire connection, screened, length <10m)	—
Parameterization				
Part no.		Voltage, current	Voltage, current	—
Averaging		Adjustable	Adjustable	—
Voltage				
Input voltage	V	0–10	0–10	—
Input impedance	k ohms	13.3	13.3	—
Maximum current				
Input current	mA	0–20	0–20	—
Input impedance	ohms	< 250	< 250	—
Resolution	Bit	12	12	—
Conversion time	ms	20	20	—
Total error	%	±1	±1	—
Repetition accuracy	%	±0.5	±0.5	—
Dielectric strength	V	±30	±30	—
<b>Analog Outputs</b>				
Number		—	Two (two-wire connection, screened)	—
Parameterization				
Part no.		—	Voltage, current	—
Averaging		—	—	—
Voltage				
Output voltage	V	—	0–10	—
Maximum output current	mA	—	10	—
Maximum current				
Output current	mA	—	0–20	—
Load resistance	ohms	—	<500	—
Overload and short-circuit proof		—	Yes	—
Resolution	Bit	—	12	—
Conversion time	ms	—	20	—
Total error	%	—	±1	—
Repetition accuracy	%	—	±0.5	—
<b>Temperature Inputs</b>				
Number		—	—	Four (two-, three-wire connection, screened, length <10m)
Parameterization				
Averaging		—	—	Adjustable
Temperature sensor		—	—	PT100, PT1000, Ni1000
Temperature range	°F (°C)	—	—	PT100, PT1000: –58° to 392° (–50° to 200°) Ni1000: –58° to 302° (–50° to 150°)
Resolution	°F (°C)	—	—	32° (0.1°)
Conversion time	ms	—	—	250
Display		—	—	°C, °F, raw value
Total error	%	—	—	±1
Repetition accuracy	%	—	—	±0.5
<b>Potential Isolation</b>				
Inputs for SmartWire-DT		Yes	Yes	Yes
Outputs to SmartWire-DT		—	Yes	—
Input to input		No	No	No
Output to input		—	No	—
Output to output		—	No	—

## Accessories

Description	Unit	SWD4-RC8-10 Resistor	SWD4-8SF2-5 Plug	SWD4-8SFF2-5 Coupling	SWD4-SF8-20 Bushing
<b>General</b>					
Standards		IEC/EN 61131-2; EN 50178	IEC/EN 61131-2; EN 50178	IEC/EN 61131-2; EN 50178	IEC/EN 61131-2; EN 50178
Dimensions (W x H x D)	in (mm)	1.91 x 1.36 x 0.34 (48.5 x 34.5 x 10)	0.59 x 1.44 x 0.69 (15 x 36.5 x 17.5)	1.91 x 1.36 x 0.34 (48.5 x 34.5 x 10)	0.94 x 1.02 x 6.34 (24 x 26 x 162)
Weight	lbs (g)	0.022 (10)	0.012.1 (5.5)	0.010 (4.5)	0.044 (20)
Mounting position		As required	As required	As required	As required
<b>Ambient Conditions, Mechanical</b>					
Degree of protection (IEC/EN 60529)		IP20	IP20	IP20	IP67
Vibrations (IEC/EN 61131-2:2008)					
Constant amplitude 3.5 mm	Hz	5–8.4	5–8.4	5–8.4	—
Constant acceleration 1g	Hz	8.4–150	8.4–150	8.4–150	—
Mechanical shock resistance (IEC/EN 60068-2-27) semi-sinusoidal 15g/11 ms	Impacts	9	9	9	—
Drop to IEC/EN 60068-2-31 (drop height)	in (mm)	1.97 (50)	—	—	—
Free fall, packaged (IEC/EN 60068-2-32)	ft (m)	1.0 (0.3)	—	—	—
<b>Electromagnetic Compatibility (EMC)</b>					
Overvoltage category		II	—	—	—
Pollution degree		2	—	—	—
Electrostatic discharge (IEC/EN 61131-2:2008)					
Air discharge (Level 3)	kV	8	—	—	—
Contact discharge (Level 2)	kV	4	—	—	—
Electromagnetic fields (IEC/EN 61131-2:2008)					
80–1000 MHz	V/m	10	—	—	—
1.4–2 GHz	V/m	3	—	—	—
2–2.7 GHz	V/m	1	—	—	—
Radio interference suppression (SmartWire-DT)		EN 55011 Class A	—	—	—
Burst (IEC/EN 61131-2:2008, Level 3)					
SmartWire-DT cables	kV	1	—	—	—
Radiated RFI (IEC/EN 61131-2:2008, Level 3)	V	10	—	—	—
<b>Climatic Environmental Conditions</b>					
Operating ambient temperature (IEC 60068-2)	°F (°C)	–13° to 131° (–25° to 55°)	–13° to 131° (–25° to 55°)	–13° to 131° (–25° to 55°)	–13° to 131° (–25° to 55°)
Condensation		Prevent with suitable measures			
Storage	°F (°C)	–40° to 158° (–40° to 70°)	–40° to 158° (–40° to 70°)	–40° to 158° (–40° to 70°)	–40° to 158° (–40° to 70°)
Relative humidity, non-condensing (IEC/EN 60068-2-30)	%	5–95	5–95	5–95	5–95
<b>Connection Options</b>					
SWD-In		Plug, 8-pole	Plug connector	Plug, 8-pole	—
Number of insertion cycles		≥200	1	>200	—
SWD-Out		—	Socket, 8-pole	Plug, 8-pole	Socket, 8-pole
Number of insertion cycles		—	≥200	≥200	≥500
Current consumption (15V SWD supply)		See <a href="#">Page V7-T9-33</a>	See <a href="#">Page V7-T9-33</a>	See <a href="#">Page V7-T9-33</a>	See <a href="#">Page V7-T9-33</a>

## Accessories, continued

Description	Unit	SWD4-SM8-20 Bushing	SWD4-8FRF-10 Adapter	SWD4-SFL8-20 Adapter	SWD4-SML8-20 Adapter
<b>General</b>					
Standards		IEC/EN 61131-2; EN 50178	IEC/EN 61131-2; EN 50178	IEC/EN 61131-2; EN 50178	IEC/EN 61131-2; EN 50178
Dimensions (W x H x D)	in (mm)	0.94 x 1.02 x 6.69 (24 x 26 x 170)	1.38 x 3.54 x 1.38 (35 x 90 x 35)	1.38 x 3.27 x 1.57 (35 x 83 x 40)	1.38 x 3.27 x 1.82 (35 x 83 x 46)
Weight	lbs (g)	0.050 (22.5)	0.093 (42)	0.110 (50)	0.110 (50)
Mounting position		As required	As required	As required	As required
<b>Ambient Conditions, Mechanical</b>					
Degree of protection (IEC/EN 60529)		IP67	IP20	IP67	IP67
Vibrations (IEC/EN 61131-2:2008)					
Constant amplitude 3.5 mm	Hz	—	5–8.4	5–8.4	5–8.4
Constant acceleration 1g	Hz	—	8.4–150	8.4–150	8.4–150
Mechanical shock resistance (IEC/EN 60068-2-27) semi-sinusoidal 15g/11 ms	Impacts	—	9	9	9
Drop to IEC/EN 60068-2-31 (drop height)	in (mm)	—	—	—	—
Free fall, packaged (IEC/EN 60068-2-32)	ft (m)	—	—	—	—
<b>Electromagnetic Compatibility (EMC)</b>					
Overvoltage category		—	—	—	—
Pollution degree		—	—	—	—
Electrostatic discharge (IEC/EN 61131-2:2008)					
Air discharge (Level 3)	kV	—	8	8	8
Contact discharge (Level 2)	kV	—	4	4	4
Electromagnetic fields (IEC/EN 61131-2:2008)					
80–1000 MHz	V/m	—	—	10	10
1.4–2 GHz	V/m	—	—	3	3
2–2.7 GHz	V/m	—	—	1	1
Radio interference suppression (SmartWire-DT)					
Burst (IEC/EN 61131-2:2008, Level 3)		—	—	—	—
SmartWire-DT cables	kV	—	—	—	—
Radiated RFI (IEC/EN 61131-2:2008, Level 3)	V	—	—	10	10
<b>Climatic Environmental Conditions</b>					
Operating ambient temperature (IEC 60068-2)	°F (°C)	–13° to 131° (–25° to 55°)	–13° to 131° (–25° to 55°)	–13° to 131° (–25° to 55°)	–13° to 131° (–25° to 55°)
Condensation		Prevent with suitable measures			
Storage	°F (°C)	–40° to 158° (–40° to 70°)	–40° to 158° (–40° to 70°)	–40° to 158° (–40° to 70°)	–40° to 158° (–40° to 70°)
Relative humidity, non-condensing (IEC/EN 60068-2-30)	%	5–95	5–95	5–95	5–95
<b>Connection Options</b>					
SWD-In		Plug, 8-pole	Plug, 8-pole	Plug, 8-pole	Plug, 8-pole
Number of insertion cycles		≥500	≥200	≥200	≥500
SWD-Out		—	Push in terminals	Socket, 8-pole	Plug, 8-pole
Number of insertion cycles		—	—	≥500	≥200
Current consumption (15V SWD supply)		See <b>Page V7-T9-33</b>	See <b>Page V7-T9-33</b>	See <b>Page V7-T9-33</b>	See <b>Page V7-T9-33</b>

## Contactor Modules

Description	Unit	DIL-SWD-32-001	DIL-SWD-32-002	PKE-SWD-32
<b>General</b>				
Standards		IEC/EN 61131-2 EN 50178 IEC/EN 60947	IEC/EN 61131-2 EN 50178 IEC/EN 60947	IEC/EN 61131-2 EN 50178 IEC/EN 60947
Dimensions (W x H x D)	in (mm)	1.77 x 1.50 x 3.0 (45 x 38 x 76)	1.77 x 1.50 x 3.0 (45 x 38 x 76)	1.77 x 1.50 x 3.0 (45 x 38 x 76)
Weight	lbs (kg)	0.9 (0.04)	0.9 (0.04)	0.9 (0.04)
Mounting		on XTCE007–XTCE032	on XTCE007–XTCE032	—
Mounting position		as XTCE007–XTCE032	as XTCE007–XTCE032	—
<b>Ambient Conditions, Mechanical</b>				
Degree of protection (IEC/EN 60529)		IP20	IP20	—
Vibrations (IEC/EN 61131-2:2008)				
Constant amplitude 3.5 mm	Hz	5–8.4	5–8.4	5–8.4
Constant acceleration 1g	Hz	8.4–150	8.4–150	8.4–150
Mechanical shock resistance (IEC/EN 60068-2-27) semi-sinusoidal 15g/11 ms	Impacts	9	9	9
Drop to IEC/EN 60068-2-31 (drop height)	in (mm)	1.97 (50)	1.97 (50)	1.97 (50)
Free fall, packaged (IEC/EN 60068-2-32)	ft (m)	1.0 (0.3)	1.0 (0.3)	1.0 (0.3)
<b>Electromagnetic Compatibility (EMC)</b>				
Overvoltage category		II	II	II
Pollution degree		2	2	2
Electrostatic discharge (IEC/EN 61131-2:2008)				
Air discharge (Level 3)	kV	8	8	8
Contact discharge (Level 2)	kV	4	4	4
Electromagnetic fields (IEC/EN 61131-2:2008)				
80–1000 MHz	V/m	10	10	10
1.4–2 GHz	V/m	3	3	3
2–2.7 GHz	V/m	1	1	1
Radio interference suppression (SmartWire-DT)		EN 55011 Class A	EN 55011 Class A	EN 55011 Class A
Burst (IEC/EN 61131-2:2008, Level 3)				
CAN/DP bus cable	kV	1	1	1
SmartWire-DT cables	kV	1	1	1
Radiated RFI (IEC/EN 61131-2:2008, Level 3)	V	10	10	10
<b>Climatic Environmental Conditions</b>				
Operating ambient temperature (IEC 60068-2)	°F (°C)	–13° to 140° (–25° to 60°)	–13° to 140° (–25° to 60°)	–13° to 140° (–25° to 60°)
Condensation		Prevent with suitable measures	Prevent with suitable measures	Prevent with suitable measures
Storage	°F (°C)	–22° to 158° (–30° to 70°)	–22° to 158° (–30° to 70°)	–22° to 158° (–30° to 70°)
Relative humidity, non-condensing (IEC/EN 60068-2-30)	%	5–95	5–95	5–95



### Contactor Modules, continued

Description	Unit	DIL-SWD-32-001	DIL-SWD-32-002	PKE-SWD-32
<b>SmartWire-DT Network</b>				
Station type		SmartWire-DT station (mode)	SmartWire-DT station (mode)	SmartWire-DT (slave)
Address allocation		Automatic	Automatic	Automatic
SmartWire-DT status LED		Green/orange	Green/orange	Green/orange
<b>Connections</b>				
Plug		8-pole	8-pole	8-pole
Plug connectors		External device plug SWD4-8SF2-5	External device plug SWD4-8SF2-5	External device plug SWD4-8SF2-5
Current consumption (15V SWD supply)		See <b>Page V7-T9-33</b>	See <b>Page V7-T9-33</b>	See <b>Page V7-T9-33</b>
<b>Mode Parameter</b>				
Manual/automatic mode		No	Yes	Yes
Setting		—	Rotary switch	Rotary switch
<b>Connection Auxiliary Contact</b>				
Number		2	2	—
Rated voltage ( $U_b$ ) <sup>①</sup>	Vdc	15	15	—
Input current at 1 signal, typical	mA	3	3	—
Potential isolation		No	No	—
Cable length	ft (m)	≤9.2 (2.8)	≤9.2 (2.8)	≤9.2 (2.8)
Connection type		Push in terminals	Push in terminals	Push in terminals
<b>Terminal Capacities</b>				
Solid	mm <sup>2</sup>	0.2–1.5 (AWG 24–16)	0.2–1.5 (AWG 24–16)	0.2–1.5 (AWG 24–16)
Flexible with ferrule <sup>②</sup>	mm <sup>2</sup>	0.25–1.5	0.25–1.5	0.25–1.5

#### Notes

① Own supply.

② Minimum length: 8 mm.

## Pilot Device Modules

Description	Unit	M22-SWD-K11	M22-SWD-KC11	M22-SWD-LED_	M22-SWD-LEDC_	M22-SWD-K11-LED_
<b>General</b>						
Standards		IEC/EN 61131-2 EN 50178	IEC/EN 61131-2 EN 50178	IEC/EN 61131-2 EN 50178	IEC/EN 61131-2 EN 50178	IEC/EN 61131-2 EN 50178
Dimensions (W x H x D)	in (mm)	0.47 x 1.65 x 1.54 (12 x 42 x 39)	0.47 x 1.77 x 1.46 (12 x 45 x 37)	0.39 x 1.65 x 1.77 (10 x 42 x 45)	0.39 x 1.77 x 1.65 (10 x 45 x 42)	0.47 x 1.65 x 1.77 (12 x 42 x 45)
Weight	lbs (g)	0.022 (10)	0.022 (10)	0.022 (10)	0.022 (10)	0.022 (10)
Mounting position		As required	As required	As required	As required	As required
<b>Ambient Conditions, Mechanical</b>						
Degree of protection (IEC/EN 60529)		IP20	IP20	IP20	IP20	IP20
Vibrations (IEC/EN 61131-2:2008)						
Constant amplitude 3.5 mm	Hz	5–8.4	5–8.4	5–8.4	5–8.4	5–8.4
Constant acceleration 1g	Hz	8.4–150	8.4–150	8.4–150	8.4–150	8.4–150
Mechanical shock resistance (IEC/EN 60068-2-27) semi-sinusoidal 15g/11 ms	Impacts	9	9	9	9	9
Drop to IEC/EN 60068-2-31 (drop height)	in (mm)	1.97 (50)	1.97 (50)	1.97 (50)	1.97 (50)	1.97 (50)
Free fall, packaged (IEC/EN 60068-2-32)	ft (m)	1.0 (0.3)	1.0 (0.3)	1.0 (0.3)	1.0 (0.3)	1.0 (0.3)
<b>Electromagnetic Compatibility (EMC)</b>						
Overvoltage category		Not applicable	Not applicable	Not applicable	Not applicable	Not applicable
Pollution degree		2	2	2	2	2
Electrostatic discharge (IEC/EN 61131-2:2008)						
Air discharge (Level 3)	kV	8	8	8	8	8
Contact discharge (Level 2)	kV	4	4	4	4	4
Electromagnetic fields (IEC/EN 61131-2:2008)						
80–1000 MHz	V/m	10	10	10	10	10
1.4–2 GHz	V/m	3	3	3	3	3
2–2.7 GHz	V/m	1	1	1	1	1
Radio interference suppression (SmartWire-DT)		EN 55011 Class A	EN 55011 Class A	EN 55011 Class A	EN 55011 Class A	EN 55011 Class A
Burst (IEC/EN 61131-2:2008, Level 3)						
Supply cables	kV	2	2	2	2	2
SmartWire-DT cables	kV	1	1	1	1	1
Radiated RFI (IEC/EN 61131-2:2008, Level 3)	V	10	10	10	10	10
<b>Climatic Environmental Conditions</b>						
Operating ambient temperature (IEC 60068-2)	°F (°C)	–22° to 131° (–30° to 55°)	–22° to 131° (–30° to 55°)	–22° to 131° (–30° to 55°)	–22° to 131° (–30° to 55°)	–22° to 131° (–30° to 55°)
Condensation		Prevent with suitable measures				
Storage	°F (°C)	–40° to 176° (–40° to 80°)	–40° to 176° (–40° to 80°)	–40° to 176° (–40° to 80°)	–40° to 176° (–40° to 80°)	–40° to 176° (–40° to 80°)
Relative humidity, non-condensing (IEC/EN 60068-2-30)	%	9–95	9–95	9–95	9–95	9–95
<b>SmartWire-DT Network</b>						
Station type		SmartWire-DT station (node)				
Address allocation		Automatic	Automatic	Automatic	Automatic	Automatic
SmartWire-DT status LED		Green	Green	Green	Green	Green
Connections						
Plug		8-pole	8-pole	8-pole	8-pole	8-pole
Plug connectors		SWD4-8SF2-5	M22-SWD-I_LP	SWD4-8SF2-5	M22-SWD-I_LP	SWD4-8SF2-5
Number of insertion cycles		≥50	≥50	≥50	≥50	≥50
Current consumption (15V SWD supply)		See <b>Page V7-T9-33</b>	See <b>Page V7-T9-33</b>	See <b>Page V7-T9-33</b>	See <b>Page V7-T9-33</b>	See <b>Page V7-T9-33</b>
<b>Function Element</b>						
Contacts		1 changeover contact	1 changeover contact	—	—	1 changeover contact
Lifespan mechanical/electrical (operations)		1 x 10 <sup>6</sup>	1 x 10 <sup>6</sup>	—	—	1 x 10 <sup>6</sup>
LED display		No	No	Yes	Yes	Yes
Diagnostics		Yes	Yes	No	No	Yes
Mounting		Front mount	Base mount	Front mount	Base mount	Front mount

## Pilot Device Modules, continued

Description	Unit	M22-SWD-K11LEDC_	M22-SWD-K22	M22-SWD-KC22	M22-SWD-K22-LED_	M22-SWD-K22LEDC_
<b>General</b>						
Standards		IEC/EN 61131-2 EN 50178	IEC/EN 61131-2 EN 50178	IEC/EN 61131-2 EN 50178	IEC/EN 61131-2 EN 50178	IEC/EN 61131-2 EN 50178
Dimensions (W x H x D)	in (mm)	0.47 x 1.77 x 1.65 (12 x 45 x 42)	0.67 x 1.65 x 1.54 (17 x 42 x 39)	0.67 x 1.77 x 1.46 (17 x 45 x 37)	0.67 x 1.65 x 1.77 (17 x 42 x 45)	0.67 x 1.77 x 1.65 (17 x 45 x 42)
Weight	lbs (g)	0.022 (10)	0.030 (14)	0.030 (14)	0.030 (14)	0.030 (14)
Mounting position		As required	As required	As required	As required	As required
<b>Ambient Conditions, Mechanical</b>						
Degree of protection (IEC/EN 60529)		IP20	IP20	IP20	IP20	IP20
Vibrations (IEC/EN 61131-2:2008)						
Constant amplitude 3.5 mm	Hz	5–8.4	5–8.4	5–8.4	5–8.4	5–8.4
Constant acceleration 1g	Hz	8.4–150	8.4–150	8.4–150	8.4–150	8.4–150
Mechanical shock resistance (IEC/EN 60068-2-27) semi-sinusoidal 15g/11 ms	Impacts	9	9	9	9	9
Drop to IEC/EN 60068-2-31 (drop height)	in (mm)	1.97 (50)	1.97 (50)	1.97 (50)	1.97 (50)	1.97 (50)
Free fall, packaged (IEC/EN 60068-2-32)	ft (m)	1.0 (0.3)	1.0 (0.3)	1.0 (0.3)	1.0 (0.3)	1.0 (0.3)
<b>Electromagnetic Compatibility (EMC)</b>						
Overvoltage category		Not applicable	Not applicable	Not applicable	Not applicable	Not applicable
Pollution degree		2	2	2	2	2
Electrostatic discharge (IEC/EN 61131-2:2008)						
Air discharge (Level 3)	kV	8	8	8	8	8
Contact discharge (Level 2)	kV	4	4	4	4	4
Electromagnetic fields (IEC/EN 61131-2:2008)						
80–1000 MHz	V/m	10	10	10	10	10
1.4–2 GHz	V/m	3	3	3	3	3
2–2.7 GHz	V/m	1	1	1	1	1
Radio interference suppression (SmartWire-DT)		EN 55011 Class A	EN 55011 Class A	EN 55011 Class A	EN 55011 Class A	EN 55011 Class A
Burst (IEC/EN 61131-2:2008, Level 3)						
Supply cables	kV	2	2	2	2	2
SmartWire-DT cables	kV	1	1	1	1	1
Radiated RFI (IEC/EN 61131-2:2008, Level 3)	V	10	10	10	10	10
<b>Climatic Environmental Conditions</b>						
Operating ambient temperature (IEC 60068-2)	°F (°C)	–22° to 131° (–30° to 55°)	–22° to 131° (–30° to 55°)	–22° to 131° (–30° to 55°)	–22° to 131° (–30° to 55°)	–22° to 131° (–30° to 55°)
Condensation		Prevent with suitable measures				
Storage	°F (°C)	–40° to 176° (–40° to 80°)	–40° to 176° (–40° to 80°)	–40° to 176° (–40° to 80°)	–40° to 176° (–40° to 80°)	–40° to 176° (–40° to 80°)
Relative humidity, non-condensing (IEC/EN 60068-2-30)	%	9–95	5–95	5–95	5–95	5–95
<b>SmartWire-DT Network</b>						
Station type		SmartWire-DT station (node)				
Address allocation		Automatic	Automatic	Automatic	Automatic	Automatic
SmartWire-DT status LED		Green	Green	Green	Green	Green
Connections						
Plug		8-pole	8-pole	8-pole	8-pole	8-pole
Plug connectors		M22-SWD-I_LP	SWD4-8SF2-5	M22-SWD-I_LP	SWD4-8SF2-5	M22-SWD-I_LP
Number of insertion cycles		≥50	≥50	≥50	≥50	≥50
Current consumption (15V SWD supply)		See <b>Page V7-T9-33</b>	See <b>Page V7-T9-33</b>	See <b>Page V7-T9-33</b>	See <b>Page V7-T9-33</b>	See <b>Page V7-T9-33</b>
<b>Function Element</b>						
Contacts		1 contact	2 contacts	2 contacts	2 contacts	2 contacts
Lifespan mechanical/electrical (operations)		1 x 10 <sup>6</sup>	1 x 10 <sup>6</sup>	1 x 10 <sup>6</sup>	1 x 10 <sup>6</sup>	1 x 10 <sup>6</sup>
LED display		Yes	No	No	Yes	Yes
Diagnostics		Yes	Yes	Yes	Yes	Yes
Mounting		Base mount	Front mount	Base mount	Front mount	Base mount

**Current Consumption Ratings****Power Consumption/Current Consumption  
24 Vdc Control Voltage  $U_{AUX}$** 

Description	Unit	DIL-SWD-32_
<b>Pick-Up Power</b>		
For XTCE007–XTCE009	W	3
For XTCE012–XTCE015	W	4,5
For XTCE018–XTCE032	W	12
<b>Pick-Up Current</b>		
For XTCE007–XTCE009	mA	125
For XTCE012–XTCE015	mA	188
For XTCE018–XTCE032	mA	500
<b>Holding Power</b>		
For XTCE007–XTCE009	W	3
For XTCE012–XTCE015	W	4,5
For XTCE018–XTCE032	W	0,5
<b>Holding Current</b>		
For XTCE007–XTCE009	mA	125
For XTCE012–XTCE015	mA	188
For XTCE018–XTCE032	mA	21

**Current Consumption 15 Vdc Supply Voltage**

Catalog Number	Current Consumption (mA)	Catalog Number	Current Consumption (mA)
DIL-SWD-32-001	40	M22-SWD-K22	7
DIL-SWD-32-002	40	M22-SWD-K22LED-B	19
EU5E-SWD-4D2R	45	M22-SWD-K22LED-G	19
EU5E-SWD-4D4D	45	M22-SWD-K22LED-R	19
EU5E-SWD-8DX	12	M22-SWD-K22LED-W	19
M22-SWD-I1-LP01 ①	17	M22-SWD-K22LEDC-B	19
M22-SWD-I2-LP01 ①	17	M22-SWD-K22LEDC-G	19
M22-SWD-I3-LP01 ①	17	M22-SWD-K22LEDC-R	19
M22-SWD-I4-LP01 ①	17	M22-SWD-K22LEDC-W	19
M22-SWD-I6-LP01 ①	17	M22-SWD-KC11	7
M22-SWD-K11	7	M22-SWD-KC22	7
M22-SWD-K11LED-B	19	M22-SWD-LED-B	19
M22-SWD-K11LED-G	19	M22-SWD-LED-G	19
M22-SWD-K11LED-R	19	M22-SWD-LED-R	19
M22-SWD-K11LED-W	19	M22-SWD-LED-W	19
M22-SWD-K11LEDC-B	19	M22-SWD-LEDC-B	19
M22-SWD-K11LEDC-G	19	M22-SWD-LEDC-G	19
M22-SWD-K11LEDC-R	19	M22-SWD-LEDC-R	19
M22-SWD-K11LEDC-W	19	M22-SWD-LEDC-W	19
		SWD4-RC8-10	17

**Note**

① With terminating resistor switched on.

#### Dimensions

Approximate Dimensions in Inches (mm)

#### Gateways

##### EU5C-SWD\_

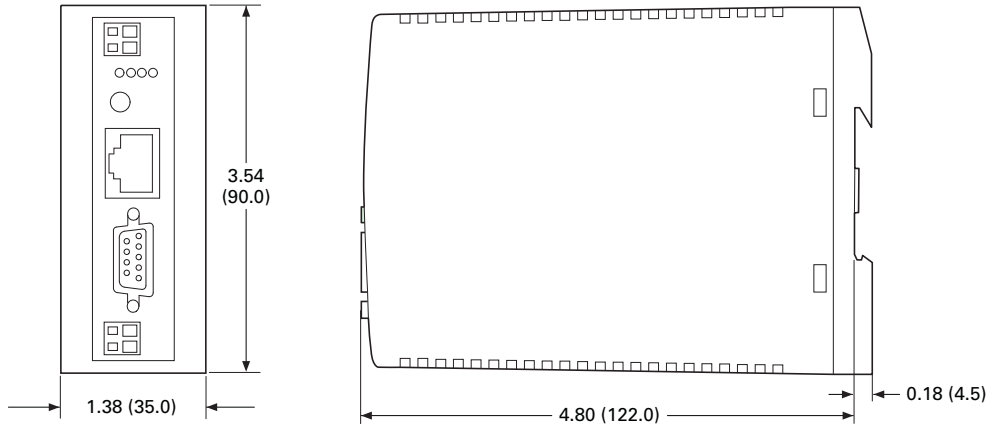

#### Powerfeed Modules

##### EU5C-SWD-PF\_

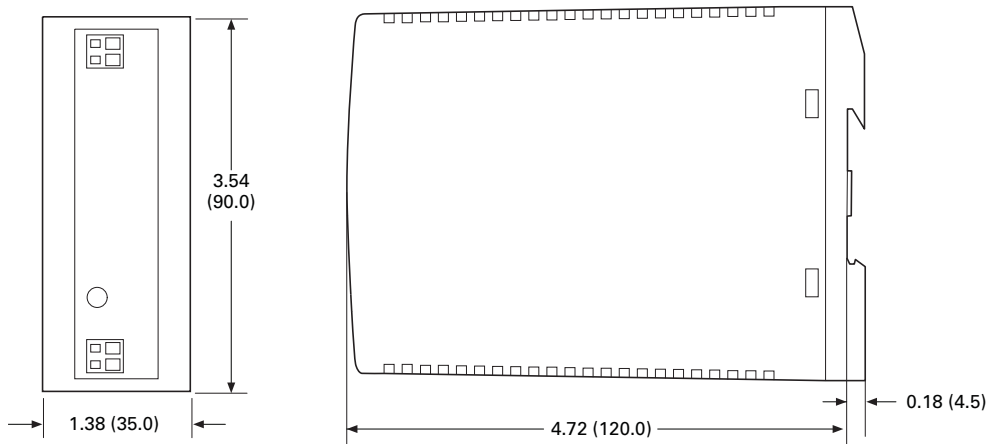

#### I/O Modules

##### EU5E-SWD\_

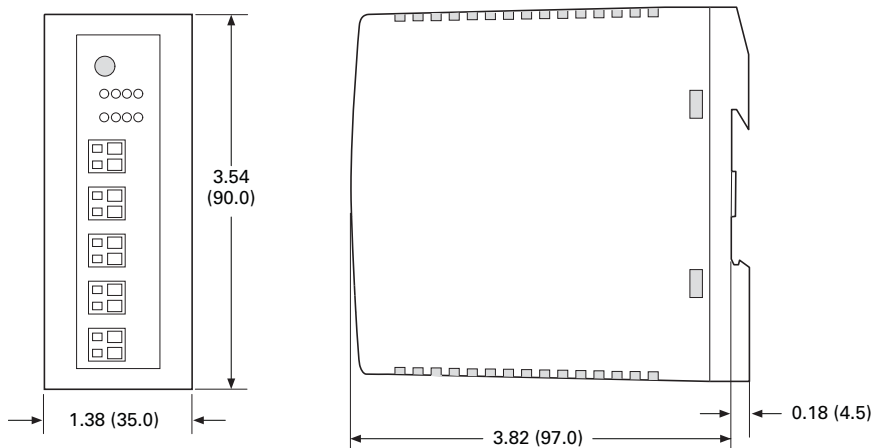

Approximate Dimensions in Inches (mm)

**Terminating Resistor**

**SWD4-RC8-10**

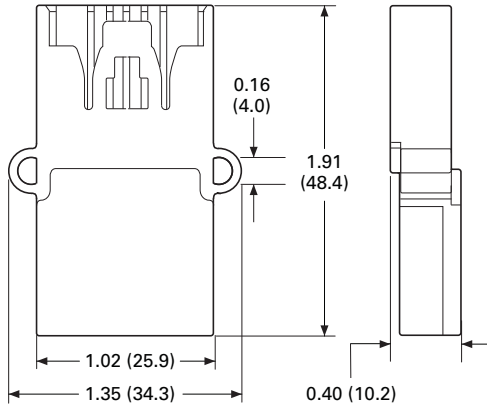

**Coupling**

**SWD4-8SFF2-5**

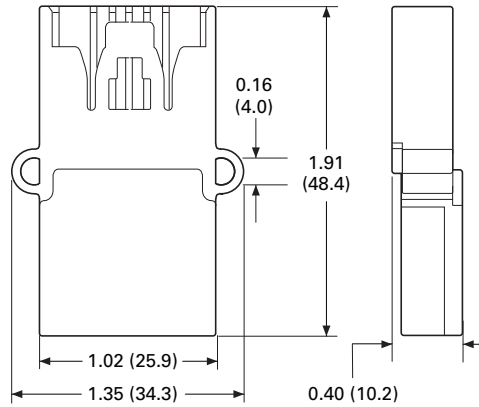

**Enclosure Bushing Plug**

**SWD4-SM8-20**

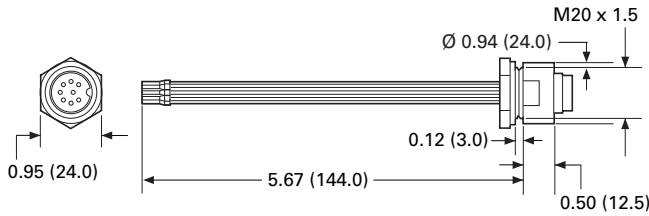

**Enclosure Bushing Socket**

**SWD4-SF8-20**

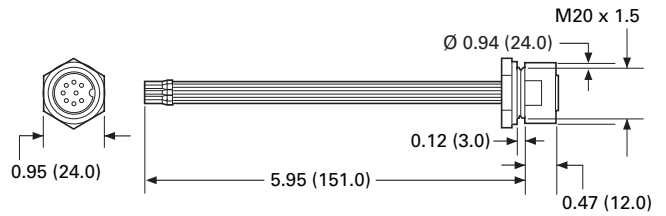

**Cabinet Cable Adapter Plug**

**SWD4-SML8-20**

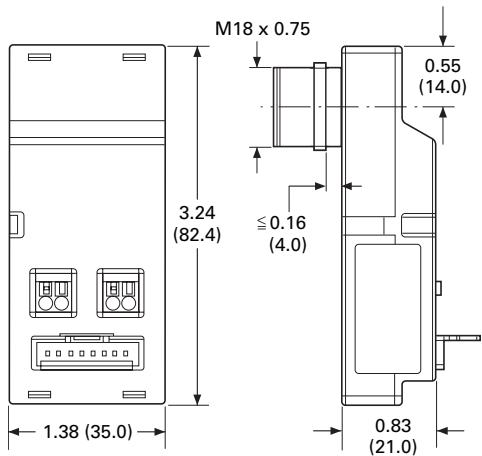

**Cabinet Cable Adapter Socket**

**SWD4-SFL8-20**

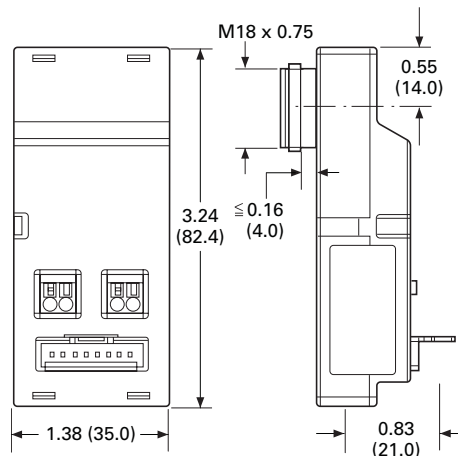

# 9.1

## Connectivity Solutions

### SmartWire-DT Panel Wiring Solution

Approximate Dimensions in Inches (mm)

#### Panel Cable Adapter

SWD4-8FRF-10

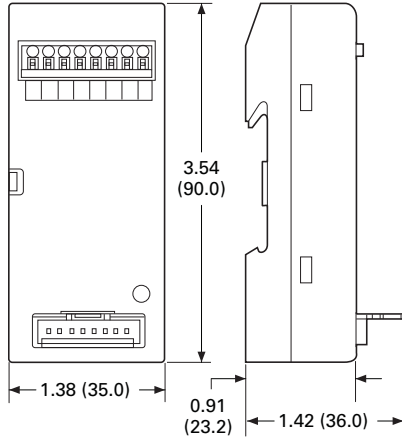

#### Round Cable Socket

SWD4-SF8-67

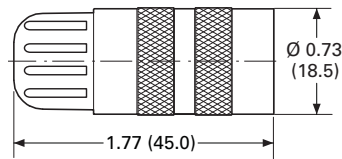

#### Round Cable Plug

SWD4-SM8-67

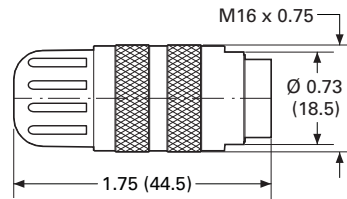

#### Right Angle Round Cable Socket

SWD4-SF8-67W

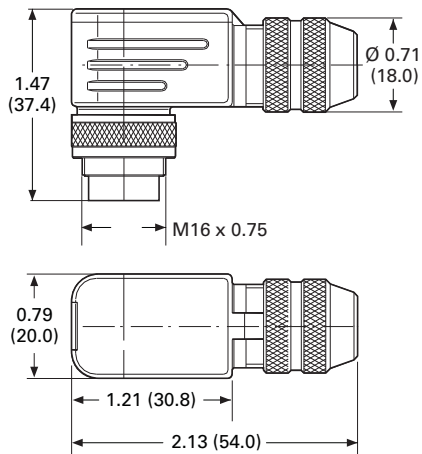

#### Right Angle Round Cable Plug

SWD4-SM8-67W

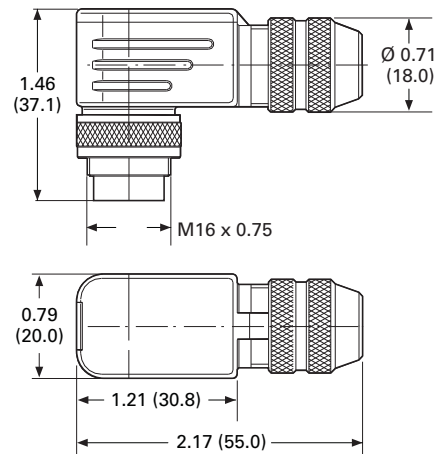



Approximate Dimensions in Inches (mm)

**Contactor Modules**

**DIL-SWD-32-001 and DIL-SWD-32-002**

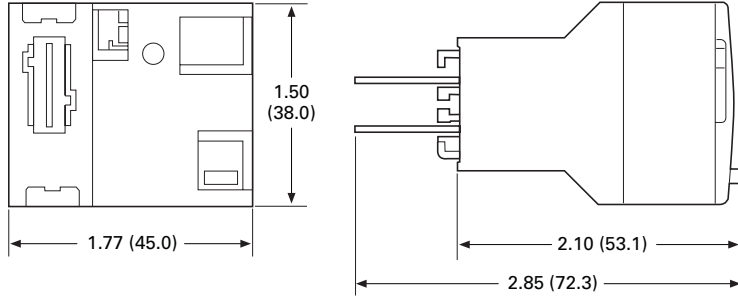

**SmartWire-DT PKE Modules**

**PKE-SWD-32**

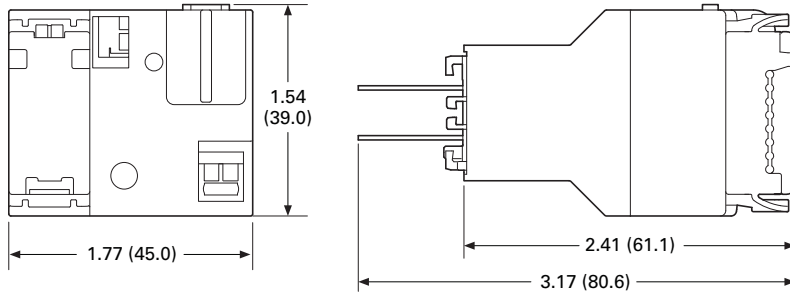

**Pilot Device Modules**

**M22-SWD-K\_, M22-SWD-LED\_**

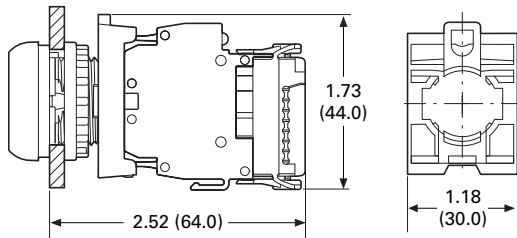

**Device Plug**

**SWD4-8SF2-5**

