

ASMT-Jx32

3W Mini Power LED Light Source

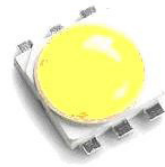

Data Sheet



Description

The 3W Mini Power LED Light Source is a high performance energy efficient device which can handle high thermal and high driving current. The metal slug is electrically isolated.

The White Mini Power LED is available in the range of color temperature from 2700K to 10000K.

The low profile package design and ultra small footprint is suitable for a wide variety of applications especially where space and height is a constraint.

The package is compatible with reflow soldering process. To facilitate easy pick & place assembly, the LEDs are packed in EIA-compliant tape and reel.

Features

- Available in Cool White, Neutral White and Warm White
- Small footprint and low profile
- Symmetrical outline
- Energy efficient
- Direct heat transfer from metal slug to mother board
- Compatible with reflow soldering process
- High current operation
- Long operation life
- Wide viewing angle
- Silicone encapsulation
- Non-ESD sensitive (threshold > 16kV)
- MSL 1 products

Applications

- Sign backlight
- Safety, exit and emergency sign lightings
- Specialty lighting such as task lighting and reading lights
- Retail display
- Commercial lighting
- Accent or marker lightings, strip or step lightings
- Portable lightings, bicycle head lamp, torch lights
- Decorative lighting
- Architectural lighting
- Pathway lighting
- Street lighting
- Pedestrian street lighting
- Tunnel lighting

CAUTION: Customer is advised to keep the LEDs in the MBB when not in use as prolonged exposure to environment might cause the silver plated leads to tarnish, which might cause difficulties in soldering.

Package Dimensions

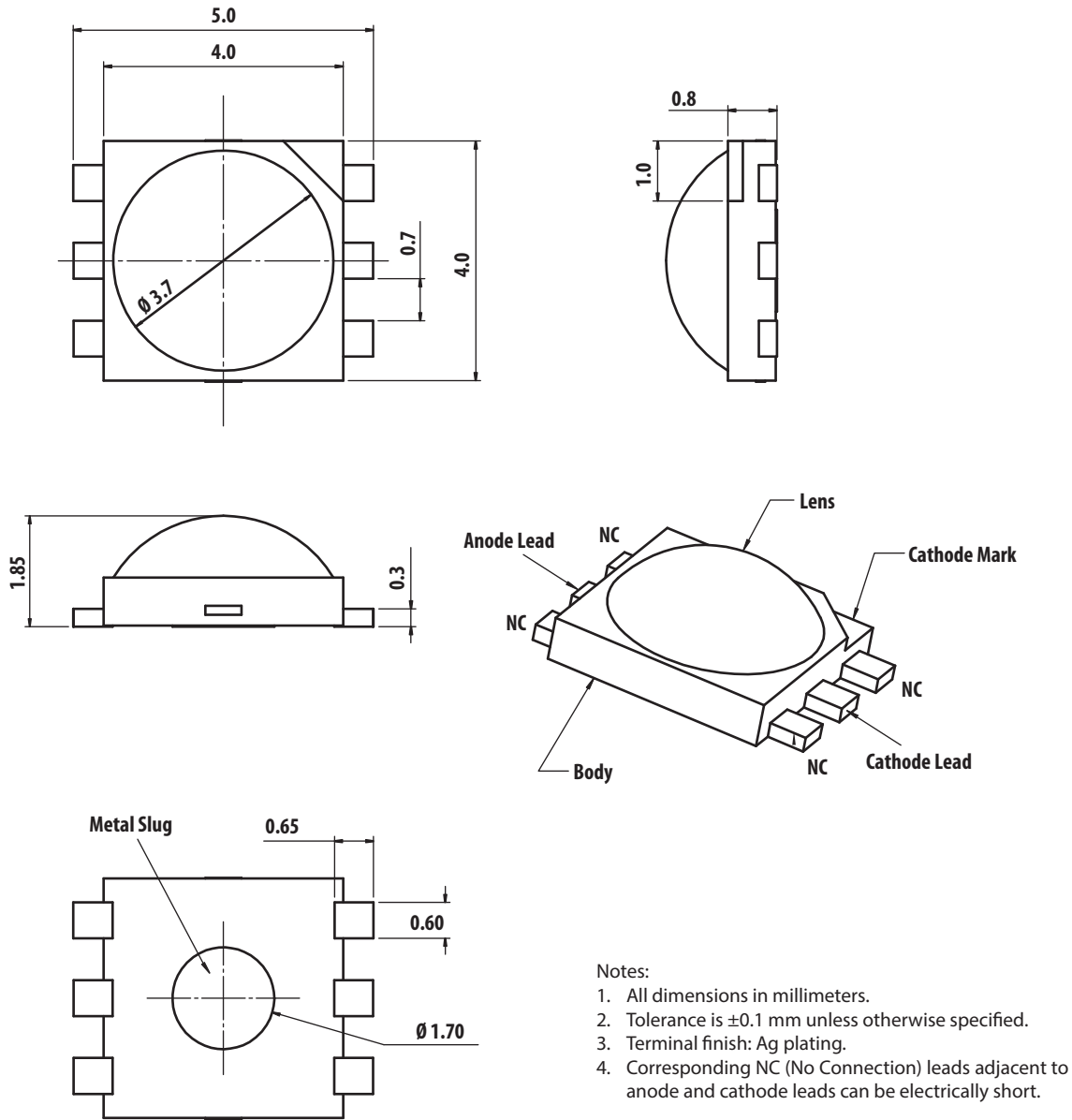
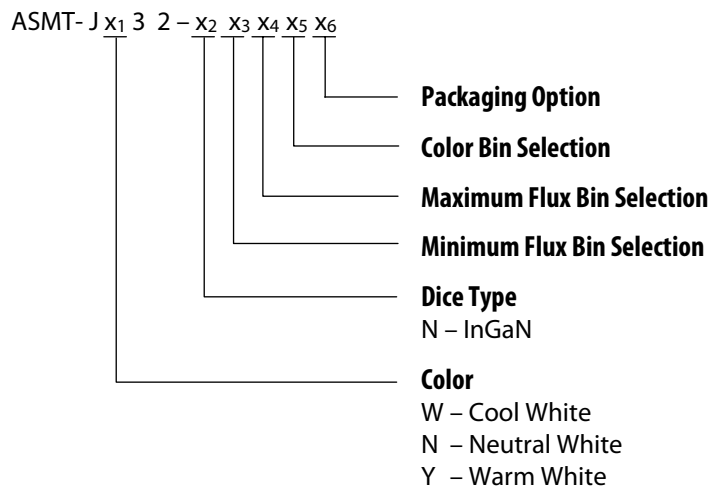

Figure 1. ASMT-Jx32 package outline drawing

Part Numbering System



Note:

1. Please refer to Page 8 for selection details.

Device Selection Guide ($T_J = 25^\circ\text{C}$)

Part Number	Color	Luminous Flux (lm), $\Phi_V^{[1,2]}$			Test Current (mA)	Dice Technology	Electrically Isolated Metal Slug
		Min.	Typ.	Max.			
ASMT-JW32-NVW01	Cool White	99.6	110.0	129.5	350	InGaN	Yes
ASMT-JW32-NWX01		113.6	125.0	147.7	350	InGaN	Yes
ASMT-JW32-NWXH1		113.6	125.0	147.7	350	InGaN	Yes
ASMT-JW32-NWXJ1		113.6	125.0	147.7	350	InGaN	Yes
ASMT-JW32-NWXK1		113.6	125.0	147.7	350	InGaN	Yes
ASMT-JN32-NWX01	Neutral White	113.6	125.0	147.7	350	InGaN	Yes
ASMT-JN32-NWXG1		113.6	125.0	147.7	350	InGaN	Yes
ASMT-JN32-NWXH1		113.6	125.0	147.7	350	InGaN	Yes
ASMT-JY32-NUW01	Warm White	87.4	105.0	129.5	350	InGaN	Yes
ASMT-JY32-NUWH1		87.4	105.0	129.5	350	InGaN	Yes
ASMT-JY32-NUWJ1		87.4	105.0	129.5	350	InGaN	Yes
ASMT-JY32-NUWK1		87.4	105.0	129.5	350	InGaN	Yes

Notes:

1. Φ_V is the total luminous flux output as measured with an integrating sphere at 25ms mono pulse condition.
2. Flux tolerance is $\pm 10\%$

Absolute Maximum Ratings

Parameter	ASMT-Jx32	Units
DC Forward Current ^[1]	700	mA
Peak Pulsing Current	2400	mA
Power Dissipation	2730	mW
LED Junction Temperature	135	°C
Operating Metal Slug Temperature Range at 350 mA	-40 to +120	°C
Operating Metal Slug Temperature Range at 700 mA	-40 to +105	°C
Storage Temperature Range	-40 to +120	°C
Soldering Temperature	Refer to Figure 15	
Reverse Voltage ^[2]	Not recommended	

Notes:

1. Derate linearly based on Figure 11.
2. Not designed for reverse bias operation.

Optical Characteristics at 350 mA (T_J = 25°C)

Part Number	Color	Correlated Color Temperature, CCT (Kelvin)		Viewing Angle, 2θ _½ ^[1] (°)	Luminous Efficiency (lm/W)
		Min.	Max.	Typ.	Typ.
ASMT-JW32-NVW01	Cool White	4500	10000	140	98
ASMT-JW32-NWX01		4500	10000	140	112
ASMT-JW32-NWXH1		4500	5650	140	112
ASMT-JW32-NWXJ1		5000	6300	140	112
ASMT-JW32-NWXK1		5650	7000	140	112
ASMT-JN32-NWX01	Neutral White	3500	4500	140	112
ASMT-JN32-NWXG1		3500	4100	140	112
ASMT-JN32-NWXH1		3800	4500	140	112
ASMT-JY32-NUW01	Warm White	2700	3500	140	94
ASMT-JY32-NUWH1		2700	3050	140	94
ASMT-JY32-NUWJ1		2850	3250	140	94
ASMT-JY32-NUWK1		3050	3500	140	94

Note:

1. θ_½ is the off-axis angle where the luminous intensity is ½ the peak intensity.

Electrical Characteristic at 350 mA ($T_J = 25^\circ\text{C}$)

Dice Type	Forward Voltage, V_F (Volts)			Thermal Resistance, $R_{\theta J-MS}(\text{°C/W})$ [1]
	Min.	Typ	Max.	Typ.
InGaN	2.8	3.2	3.5	9

Note:

1. $R_{\theta J-MS}$ is Thermal Resistance from LED junction to metal slug.

Optical and Electrical Characteristic at 700 mA ($T_J = 25^\circ\text{C}$)

Part Number	Color	Luminous Flux (lm), ϕ_v	Forward Voltage, V_F (Volts)
		Typ.	Typ.
ASMT-JW32-NVW01	Cool White	187.0	3.6
ASMT-JW32-NWX01		213.0	3.6
ASMT-JW32-NWXH1		213.0	3.6
ASMT-JW32-NWXJ1		213.0	3.6
ASMT-JW32-NWXK1		213.0	3.6
ASMT-JN32-NWX01	Neutral White	213.0	3.6
ASMT-JN32-NWXG1		213.0	3.6
ASMT-JN32-NWXH1		213.0	3.6
ASMT-JY32-NUW01	Warm White	179.0	3.6
ASMT-JY32-NUWH1		179.0	3.6
ASMT-JY32-NUWJ1		179.0	3.6
ASMT-JY32-NUWK1		179.0	3.6

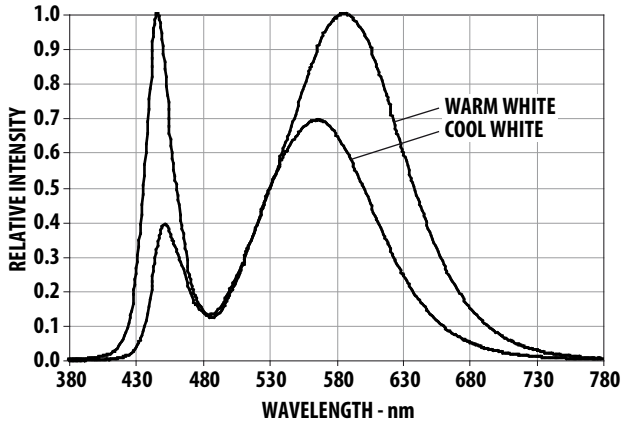

Figure 2. Relative Intensity vs. Wavelength for Cool White and Warm White

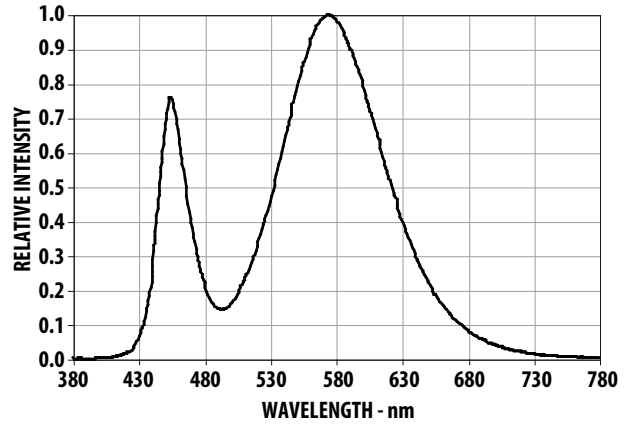

Figure 3. Relative Intensity vs. Wavelength for Neutral White

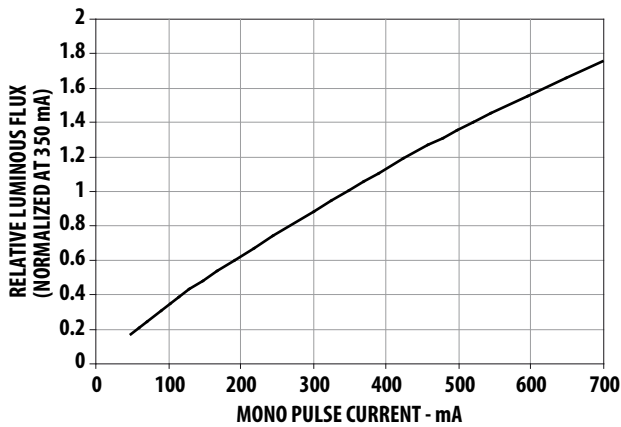

Figure 4. Relative Luminous Flux vs. Mono Pulse Current

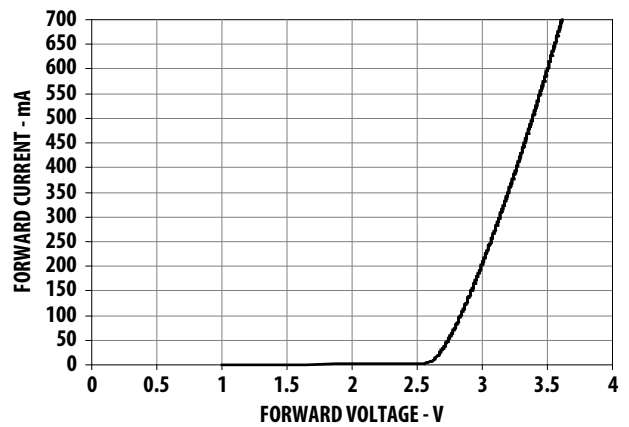

Figure 5. Forward Current vs. Forward Voltage

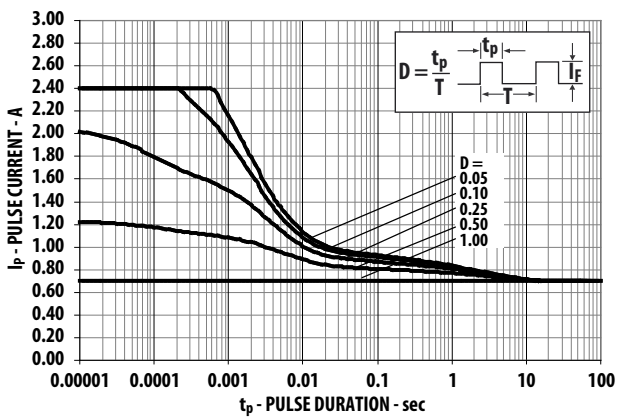

Figure 6. Maximum pulse current vs. pulse duration
Derated based on $T_A = 25^\circ\text{C}$, $R\theta_{J-A} = 30^\circ\text{C/W}$.

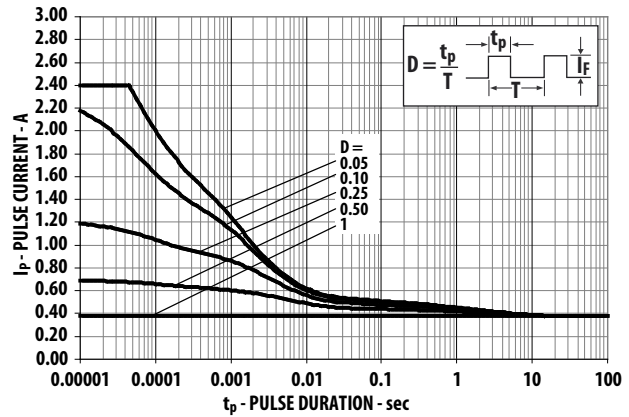

Figure 7. Maximum pulse current vs. pulse duration
Derated based on $T_A = 85^\circ\text{C}$, $R\theta_{J-A} = 30^\circ\text{C/W}$.

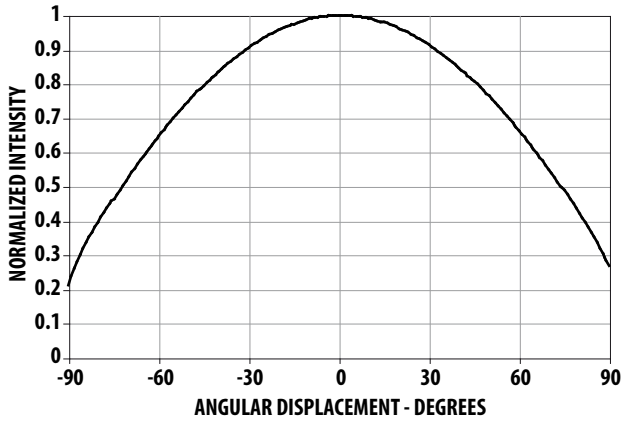

Figure 8. Radiation Pattern for Cool White, Warm White and Neutral White

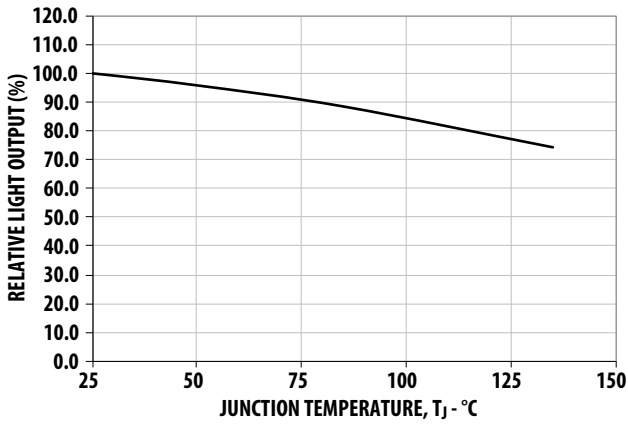

Figure 9. Relative Light Output vs. Junction Temperature

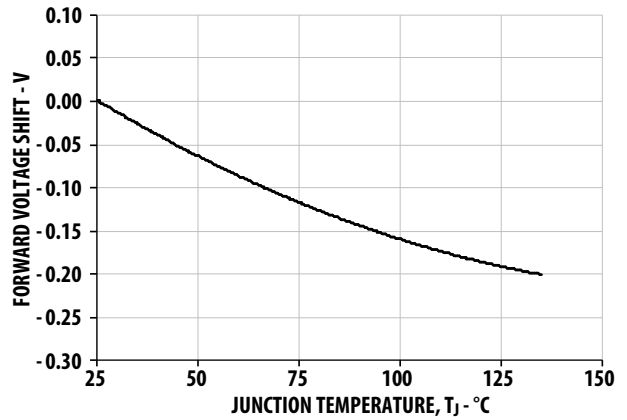

Figure 10. Forward Voltage Shift vs. Junction Temperature

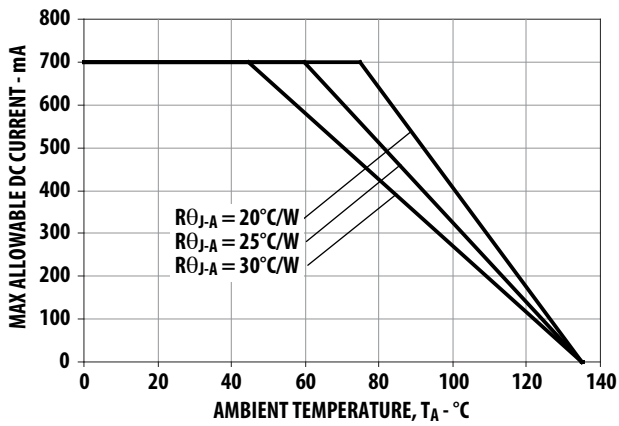

Figure 11. Maximum Forward Current vs. Ambient Temperature. Derated based on $T_{JMAX} = 135^\circ\text{C}$, $R_{\theta J-A} = 20^\circ\text{C/W}$, 25°C/W and 30°C/W

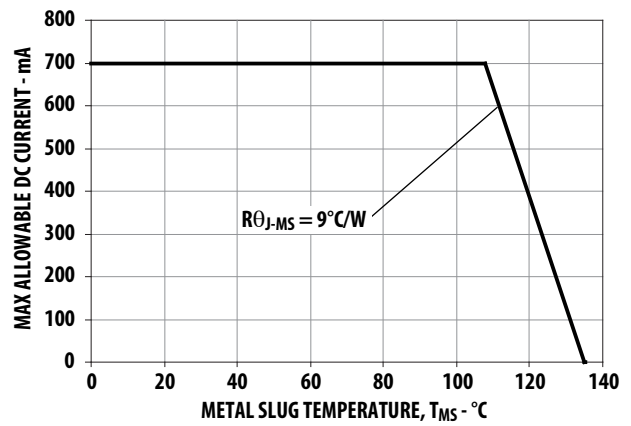

Figure 12. Maximum Forward Current vs. Metal Slug Temperature. Derated based on $T_{JMAX} = 135^\circ\text{C}$, $R_{\theta J-MS} = 9^\circ\text{C/W}$

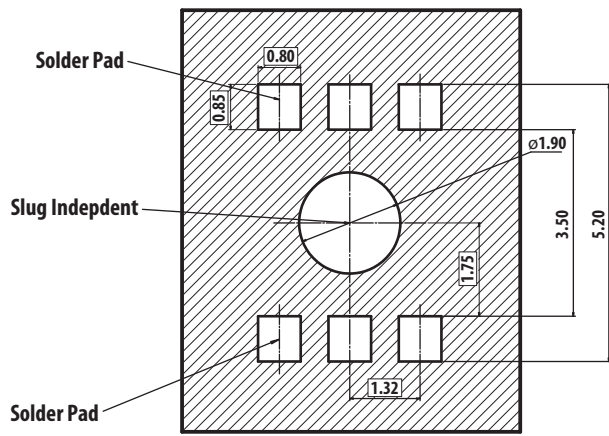

Figure 13. Recommended soldering land pattern

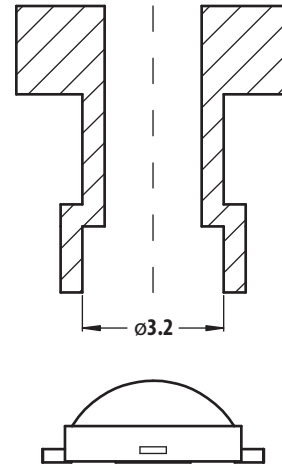

Figure 14. Recommended pick and place nozzle tip. Inner diameter = 3.2 mm

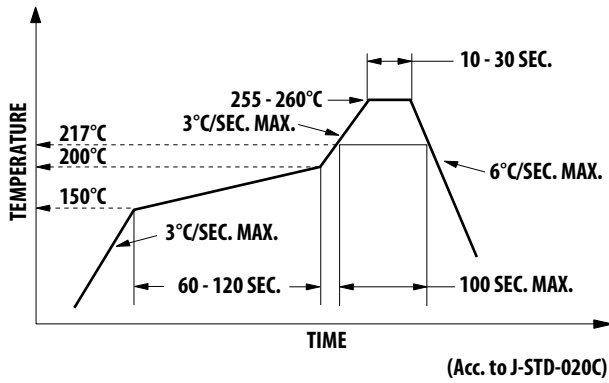

Figure 15. Recommended Reflow Soldering Profile

Note:

For detail information on reflow soldering of Avago surface mount LEDs, do refer to Avago Application Note AN1060 Surface Mounting SMT LED Indicator Components.

Option Selection Details

ASMT-J x₁ 3 2 – x₂ x₃ x₄ x₅ x₆

x₃ – Minimum Flux Bin Selection

x₄ – Maximum Flux Bin Selection

x₅ – Color Bin Selection

x₆ – Packaging Option

Flux Bin Limit [x₃, x₄]

Bin ID	Luminous Flux (lm) at 350 mA	
	Min.	Max.
U	87.4	99.6
V	99.6	113.6
W	113.6	129.5
X	129.5	147.7

Color Bin Selection [x₅]

Individual reel will contain parts from one color bin selection only.

Cool White

Selection	Bin ID
0	Full Distribution
E	VM, UM, VN and UN
F	WM, VM, WN and VN
G	XM, WM, XN and WN
H	UN, VN, U0 and V0
J	WN, VN, W0 and V0
K	XN, WN, X0 and W0
L	V0, U0, VP and UP
M	W0, V0, WP, VP and WQ
N	X0, W0, XP, WP and WQ
P	Y0
Q	YA

Warm White

Selection	Bin ID
0	Full Distribution
E	NM, MM, N1 and M1
F	PM, NM, P1 and N1
G	QM, PM, Q1 and P1
H	M1, N1, M0 and N0
J	P1, N1, P0 and N0
K	Q1, P1, Q0 and P0
L	N0, M0, NA and MA
M	P0, N0, PA and NA
N	Q0, P0, QA and PA

Neutral White

Selection	Bin ID
0	Full Distribution
E	SM, RM, S1 and R1
F	TM, SM, TN and S1
G	S1, R1, S0 and R0
H	TN, S1, T0 and S0
J	S0, R0, SA and RA
K	T0, S0, TP and SA

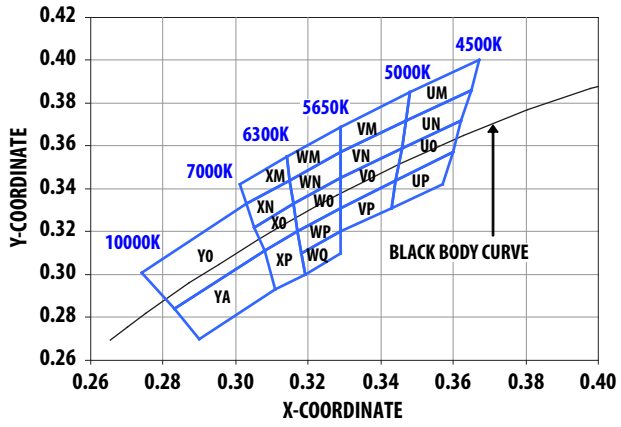

Figure 16. Color bin Structure for Cool White

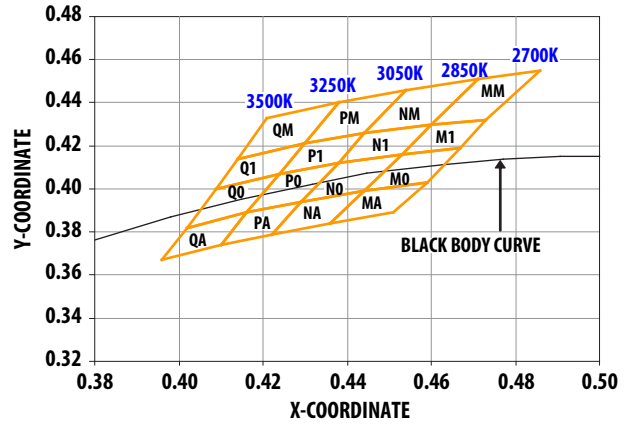

Figure 17. Color bin structure for Warm White

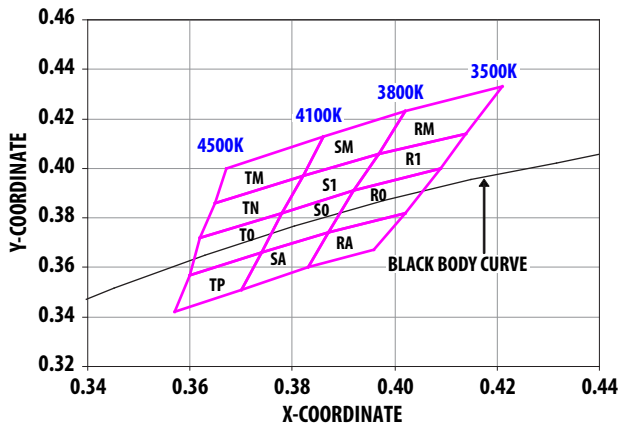

Figure 18. Color bin structure for Neutral White

Color Bin Limits

Cool White	Color Limits (Chromaticity Coordinates)				
Bin UM	x	0.365	0.367	0.348	0.347
	y	0.386	0.400	0.385	0.372
Bin UN	x	0.365	0.362	0.346	0.347
	y	0.386	0.372	0.359	0.372
Bin U0	x	0.362	0.360	0.344	0.346
	y	0.372	0.357	0.344	0.359
Bin UP	x	0.360	0.357	0.343	0.344
	y	0.357	0.342	0.331	0.344
Bin VM	x	0.329	0.329	0.348	0.347
	y	0.357	0.369	0.385	0.372
Bin VN	x	0.329	0.329	0.347	0.346
	y	0.345	0.357	0.372	0.359
Bin V0	x	0.329	0.329	0.346	0.344
	y	0.331	0.345	0.359	0.344
Bin VP	x	0.329	0.344	0.343	0.329
	y	0.331	0.344	0.331	0.320
Bin WM	x	0.329	0.329	0.315	0.314
	y	0.369	0.357	0.344	0.355
Bin WN	x	0.329	0.316	0.315	0.329
	y	0.345	0.333	0.344	0.357
Bin W0	x	0.329	0.329	0.317	0.316
	y	0.345	0.331	0.320	0.333
Bin WP	x	0.329	0.329	0.318	0.317
	y	0.331	0.320	0.310	0.320
Bin WQ	x	0.329	0.329	0.319	0.318
	y	0.320	0.310	0.300	0.310
Bin XM	x	0.301	0.314	0.315	0.303
	y	0.342	0.355	0.344	0.333
Bin XN	x	0.305	0.303	0.315	0.316
	y	0.322	0.333	0.344	0.333
Bin XO	x	0.308	0.305	0.316	0.317
	y	0.311	0.322	0.333	0.320
Bin XP	x	0.308	0.317	0.319	0.311
	y	0.311	0.320	0.300	0.293
Bin YO	x	0.308	0.283	0.274	0.303
	y	0.311	0.284	0.301	0.333
Bin YA	x	0.308	0.311	0.290	0.283
	y	0.311	0.293	0.270	0.284

Tolerance: ±0.01

Warm White	Color Limits (Chromaticity Coordinates)				
Bin MM	x	0.471	0.460	0.473	0.486
	y	0.451	0.430	0.432	0.455
Bin M1	x	0.460	0.453	0.467	0.473
	y	0.430	0.416	0.419	0.432
Bin M0	x	0.453	0.444	0.459	0.467
	y	0.416	0.399	0.403	0.419
Bin MA	x	0.459	0.444	0.436	0.451
	y	0.403	0.399	0.384	0.389
Bin NM	x	0.454	0.444	0.460	0.471
	y	0.446	0.426	0.430	0.451
Bin N1	x	0.444	0.438	0.453	0.460
	y	0.426	0.412	0.416	0.430
Bin N0	x	0.438	0.429	0.444	0.453
	y	0.412	0.394	0.399	0.416
Bin NA	x	0.444	0.429	0.422	0.436
	y	0.399	0.394	0.379	0.384
Bin PM	x	0.438	0.430	0.444	0.454
	y	0.440	0.421	0.426	0.446
Bin P1	x	0.430	0.424	0.438	0.444
	y	0.421	0.407	0.412	0.426
Bin P0	x	0.424	0.416	0.429	0.438
	y	0.407	0.389	0.394	0.412
Bin PA	x	0.429	0.416	0.410	0.422
	y	0.394	0.389	0.374	0.379
Bin QM	x	0.421	0.414	0.430	0.438
	y	0.433	0.414	0.421	0.440
Bin Q1	x	0.414	0.409	0.424	0.430
	y	0.414	0.400	0.407	0.421
Bin Q0	x	0.409	0.402	0.416	0.424
	y	0.400	0.382	0.389	0.407
Bin QA	x	0.416	0.402	0.396	0.410
	y	0.389	0.382	0.367	0.374

Tolerance: ±0.01

Neutral White	Color Limits (Chromaticity Coordinates)				
		x	y	z	u
Bin RM	x	0.421	0.414	0.397	0.402
	y	0.433	0.414	0.406	0.423
Bin R1	x	0.414	0.409	0.392	0.397
	y	0.414	0.400	0.391	0.406
Bin R0	x	0.392	0.387	0.402	0.409
	y	0.391	0.374	0.382	0.400
Bin RA	x	0.387	0.383	0.396	0.402
	y	0.374	0.360	0.367	0.382
Bin SM	x	0.402	0.397	0.382	0.386
	y	0.423	0.406	0.397	0.413
Bin S1	x	0.397	0.392	0.378	0.382
	y	0.406	0.391	0.382	0.397
Bin S0	x	0.392	0.387	0.374	0.378
	y	0.391	0.374	0.366	0.382
Bin SA	x	0.387	0.383	0.370	0.374
	y	0.374	0.360	0.351	0.366
Bin TM	x	0.386	0.382	0.365	0.367
	y	0.413	0.397	0.386	0.400
Bin TN	x	0.382	0.378	0.362	0.365
	y	0.397	0.382	0.372	0.386
Bin T0	x	0.378	0.374	0.360	0.362
	y	0.382	0.366	0.357	0.372
Bin TP	x	0.374	0.370	0.357	0.360
	y	0.366	0.351	0.342	0.357

Tolerance: ± 0.01

Packaging Option [x₆]

Selection	Option
1	Tape and Reel

Example

ASMT-JW32-NUV01

ASMT-JW32-Nxxxx – Cool White, InGaN,
Electrically isolated Heat Sink

- X₃ = U – Minimum Flux Bin U
- X₄ = V – Maximum Flux Bin V
- X₅ = 0 – Full Distribution
- X₆ = 1 – Tape and Reel Option

Tape and Reel – Option 1

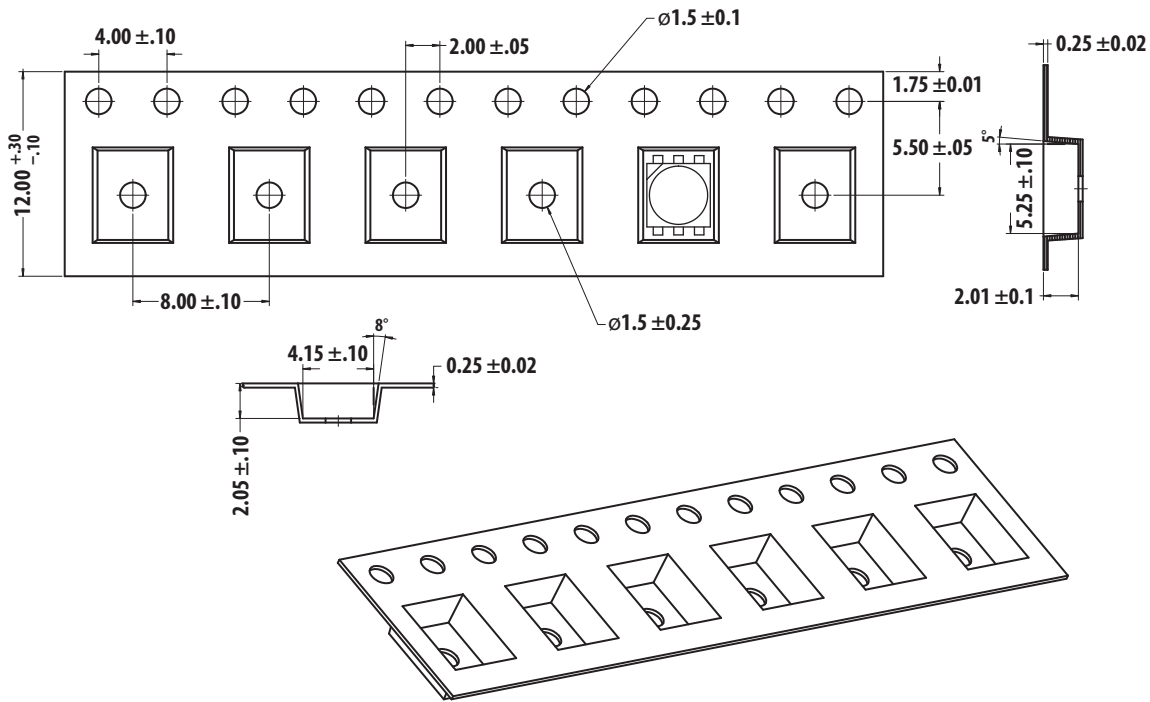
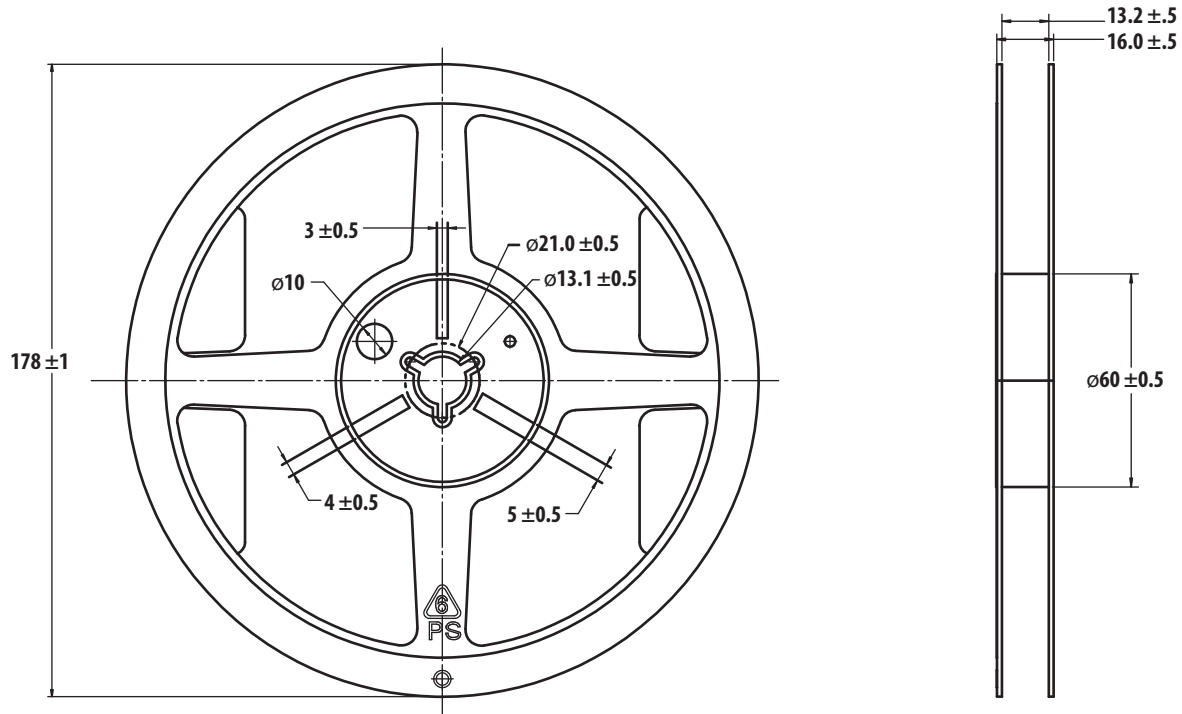

Figure 19. Carrier Tape Dimensions



Notes:

1. Empty component pockets sealed with top cover tape.
2. 250 or 500 pieces per reel.
3. Drawing not to scale.
4. All dimensions are in millimeters.

Figure 20. Reel dimensions

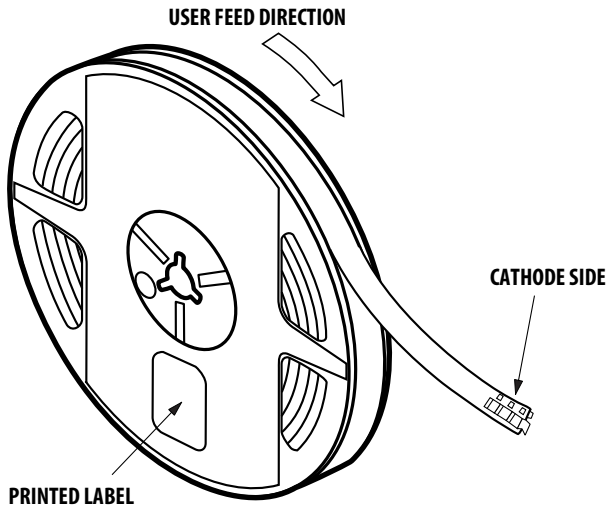

Figure 21. Reeling Orientation

DISCLAIMER: Avago's products and software are not specifically designed, manufactured or authorized for sale as parts, components or assemblies for the planning, construction, maintenance or direct operation of a nuclear facility or for use in medical devices or applications. Customer is solely responsible, and waives all rights to make claims against avago or its suppliers, for all loss, damage, expense or liability in connection with such use.

For product information and a complete list of distributors, please go to our web site: www.avagotech.com

Avago, Avago Technologies, and the A logo are trademarks of Avago Technologies in the United States and other countries. Data subject to change. Copyright © 2005-2014 Avago Technologies. All rights reserved.
AV02-2428EN - February 6, 2014

AVAGO
TECHNOLOGIES