

# ASMT-UWBG, ASMT-UWBH

## 0.25 W Cool White Power PLCC4

### Surface Mount LED



## Data Sheet



### Description

The Avago Technologies ASMT-UWBx series 0.25W Cool White Power PLCC4 SMT LED lamps use InGaN chip technology and superior package design to enable them to produce higher light output with better flux performance. They can be driven at high current and are able to dissipate the heat more efficiently resulting in better performance with higher reliability. These lamps are able to operate under a wide range of environmental conditions making them ideal for various applications including fluorescent replacement, under cabinet lighting, retail display lighting and panel lights.

To facilitate easy pick and place assembly, the LEDs are packed in EIA-compliant tape and reel. Every reel is shipped in single intensity and color bin, to provide close uniformity.

### Features

- 4000 K to 8000 K CCT
- ANSI bin
- Wide view angle 120°
- High reliability package with enhanced silicone resin encapsulation

### Applications

- Fluorescent replacement
- Under cabinet lighting
- Panel lights
- Retail display lighting

**CAUTION:** Static sensitive device. Please observe appropriate precautions during handling and processing.

## Package Drawing

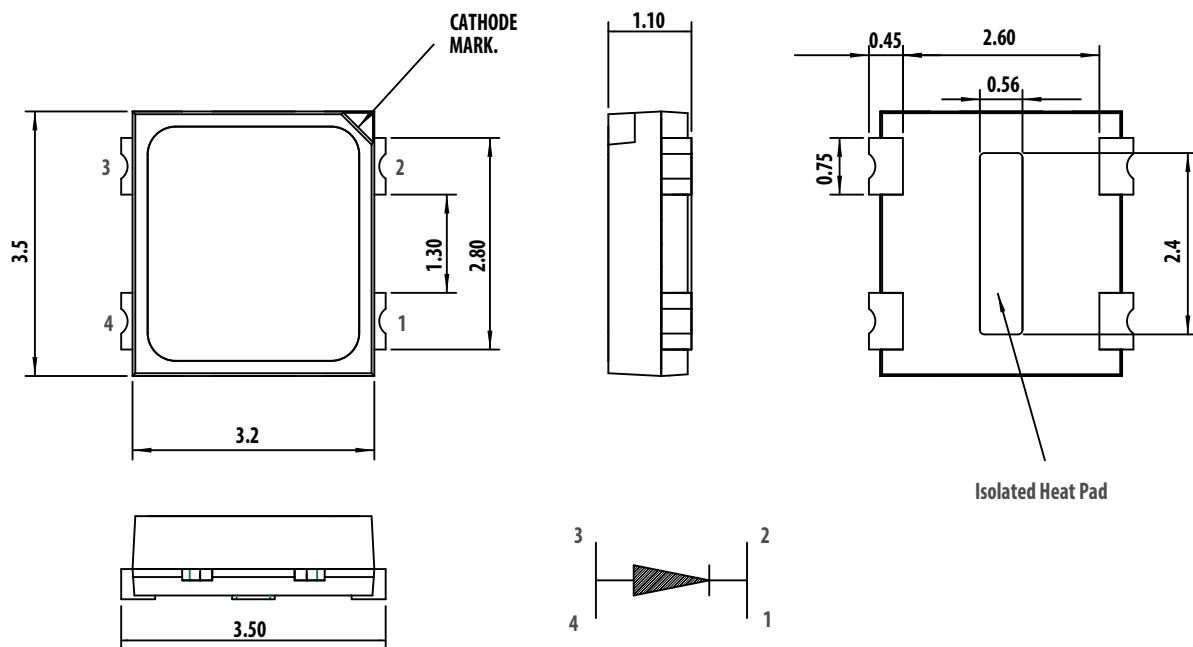

### Notes:

1. Dimensions in mm.
2. Tolerance  $xx.x \pm 0.2$ .
3. Tolerance  $xx.xx \pm 0.1$ .
4. Terminal Finish: Ag plating.

## Device Selection Guide

Color	Part Number	CCT (K)	CRI				Luminous Flux (lm) <sup>1,2</sup>		Test Current (mA)	Chip
			Typ	Min	Typ	Max	Typ	Max		
Cool White	ASMT-UWBG-NAC08	4000 ~ 8000	85	18.1	19.0	35.2	80	InGaN		
Cool White	ASMT-UWBG-NACA8	8000	85	18.1	19.0	35.2	80	InGaN		
Cool White	ASMT-UWBG-NACB8	6500	85	18.1	19.0	35.2	80	InGaN		
Cool White	ASMT-UWBG-NACC8	5700	85	18.1	19.0	35.2	80	InGaN		
Cool White	ASMT-UWBG-NACD8	5000	85	18.1	19.0	35.2	80	InGaN		
Cool White	ASMT-UWBG-NACE8	4500	85	18.1	19.0	35.2	80	InGaN		
Cool White	ASMT-UWBG-NACF8	4000	85	18.1	19.0	35.2	80	InGaN		
Cool White	ASMT-UWBH-NBD08	4000 ~ 8000	75	23.5	24.7	39.8	80	InGaN		
Cool White	ASMT-UWBH-NBDA8	8000	75	23.5	24.7	39.8	80	InGaN		
Cool White	ASMT-UWBH-NBDB8	6500	75	23.5	24.7	39.8	80	InGaN		
Cool White	ASMT-UWBH-NBDC8	5700	75	23.5	24.7	39.8	80	InGaN		
Cool White	ASMT-UWBH-NBDD8	5000	75	23.5	24.7	39.8	80	InGaN		
Cool White	ASMT-UWBH-NBDE8	4500	75	23.5	24.7	39.8	80	InGaN		
Cool White	ASMT-UWBH-NBDF8	4000	75	23.5	24.7	39.8	80	InGaN		

### Notes:

1. Luminous flux is the total luminous flux output as measured with an integrating sphere at mono pulse conditions.
2. Tolerance  $\pm 12\%$ .

## Part Numbering System

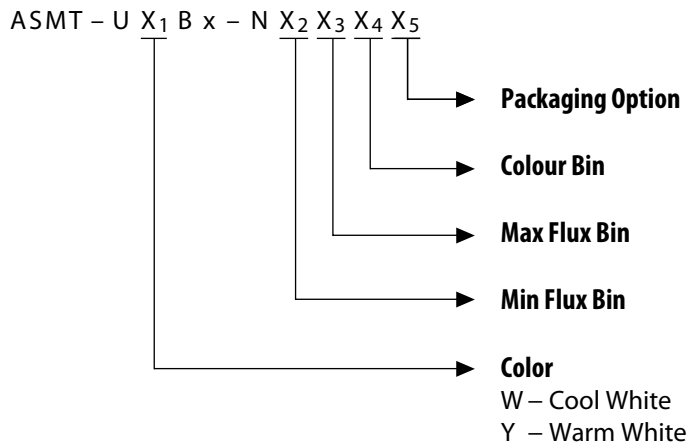

### Absolute Maximum Ratings ( $T_A = 25^\circ\text{C}$ )

Parameter	Rating	Unit
DC Forward Current	100	mA
Peak Forward Current (D = 10%, f = 1 kHz)	200	mA
Power Dissipation	360	mW
Reverse Voltage	Not recommended	V
Junction Temperature	125	$^\circ\text{C}$
Operating Temperature	-40 to 100	$^\circ\text{C}$
Storage Temperature	-40 to 100	$^\circ\text{C}$

### Optical / Electrical Characteristics ( $T_J = 25^\circ\text{C}$ )

Parameter	Test Condition	Min	Typ	Max	Unit
Viewing Angle $2\theta_{1/2}$ <sup>1</sup>			120		degree
Forward Voltage $V_F$ <sup>2</sup>	$I_F = 80\text{ mA}$		3.2	3.4	V
Thermal Resistance $R_{TH}$	junction to pin		50		$^\circ\text{C}/\text{W}$

Notes:

- $\theta_{1/2}$  is the off-axis angle where the luminous intensity is  $\frac{1}{2}$  the peak intensity.
- Tolerance  $\pm 0.1\text{ V}$ .

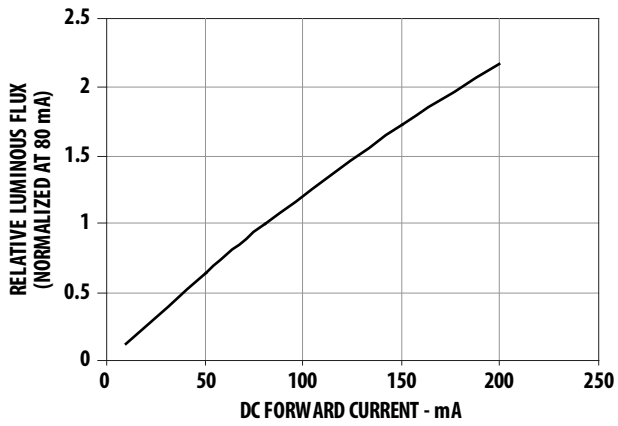

Figure 1. Relative Luminous Flux vs. Forward Current

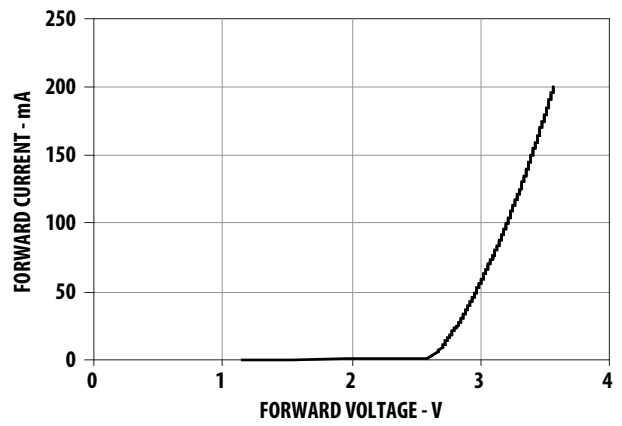

Figure 2. Forward Current vs. Forward Voltage

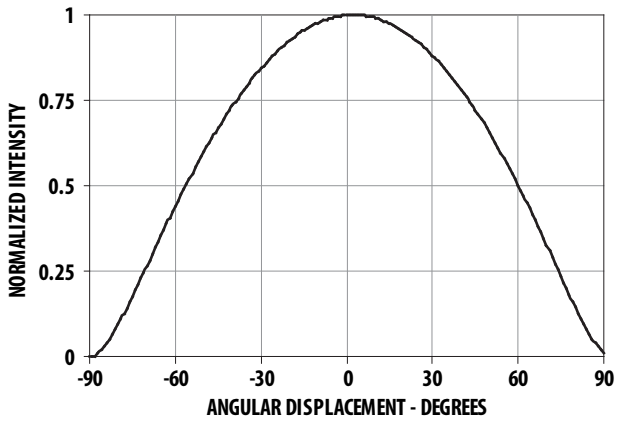

Figure 3. Radiation Diagram

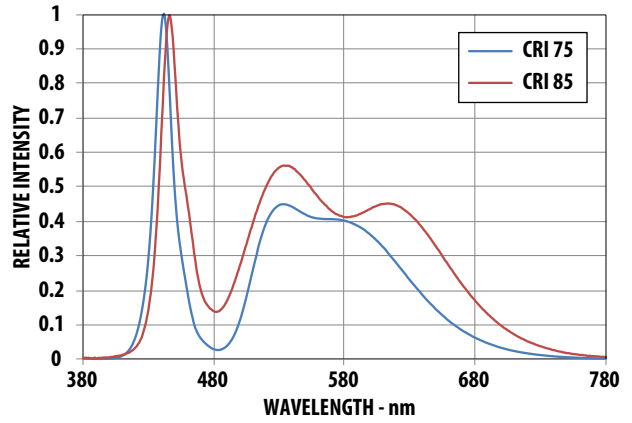

Figure 4. Spectrum Distribution

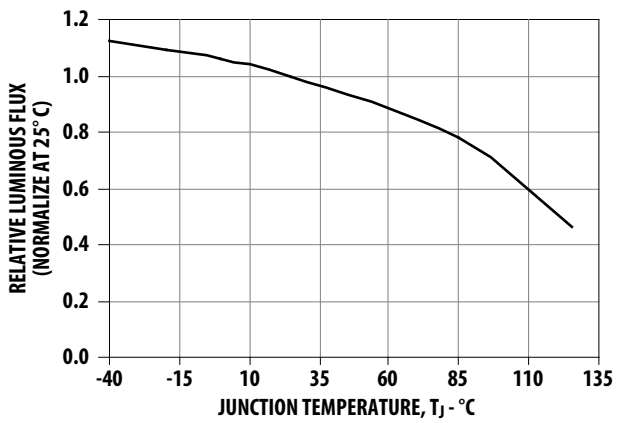

Figure 5. Relative Light Output

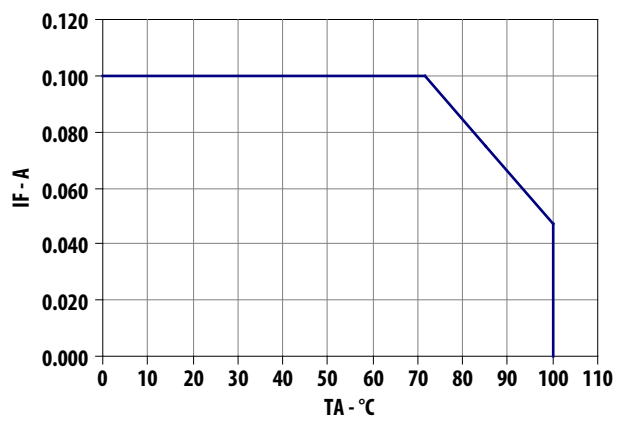

Figure 6. Forward Current Derating Curve. RTHja 140°C/W.

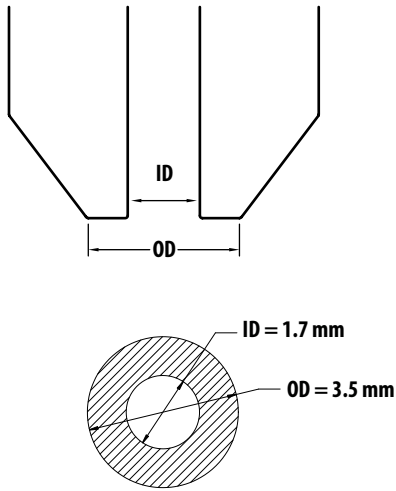

Figure 7. Recommended Pick and Place Nozzle Size

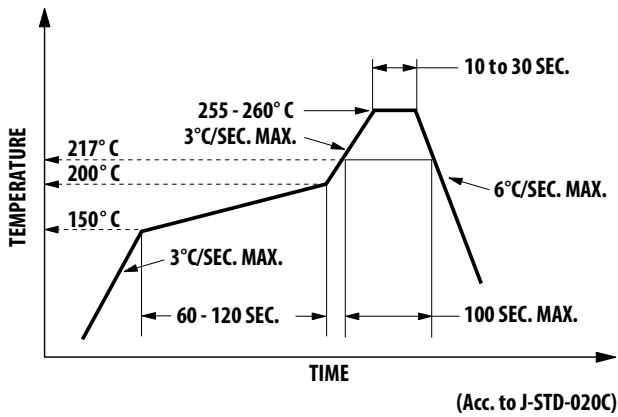

Figure 8. Recommended Pb Free Reflow Soldering Profile

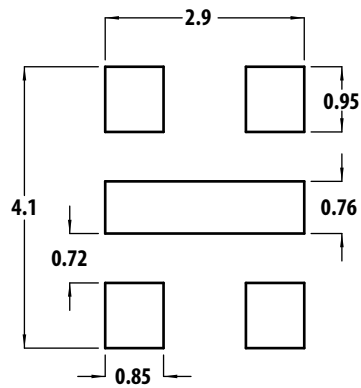

Figure 9. Recommended Solder Pad

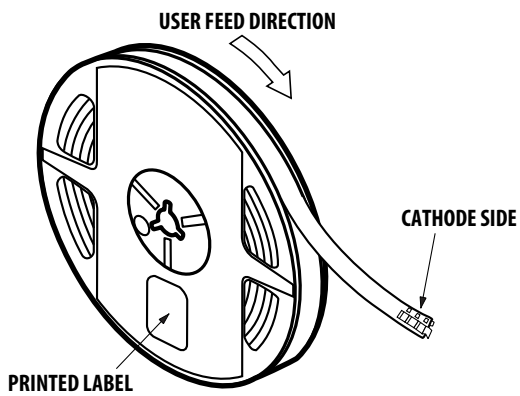

Figure 10. Reeling Orientation

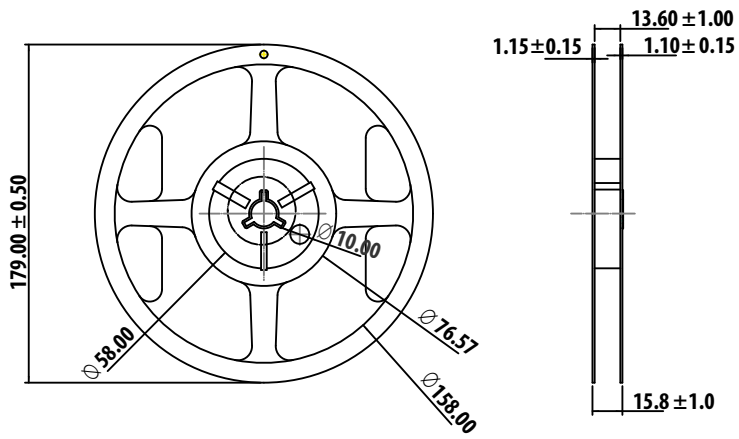

Figure 11. Reel Dimensions

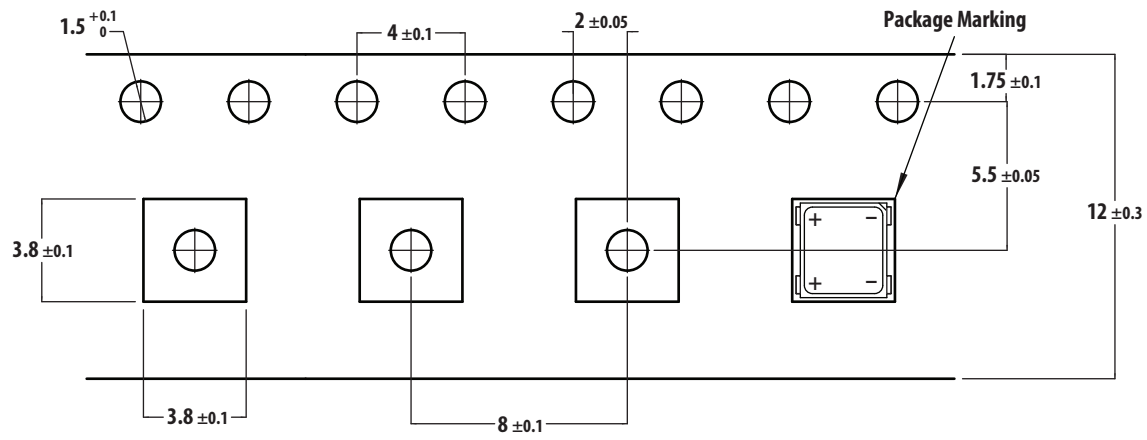

Figure 12. Carrier Tape Dimensions

## Handling Precaution

The encapsulation material of the product is made of silicone for better reliability of the product. As silicone is a soft material, please do not press on the silicone or poke a sharp object onto the silicone. These might damage the product and cause premature failure. During assembly or handling, the unit should be held on the body only.

## Moisture Sensitivity

This product is qualified as Moisture Sensitive Level 2 per Jedec J-STD-020. Precautions when handling this moisture sensitive product is important to ensure the reliability of the product.

### A. Storage before use

- Unopen moisture barrier bag (MBB) can be stored at <40°C/90%RH for 12 months. If the actual shelf life has exceeded 12 months and the HIC indicates that baking is not required, then it is safe to reflow the LEDs per the original MSL rating.
- It is not recommended to open the MBB prior to assembly (e.g. for IQC).

### B. Control after opening the MBB

- The humidity indicator card (HIC) shall be read immediately upon opening of MBB.
- The LEDs must be kept at <30°C / 60%RH at all time and all high temperature related process including soldering, curing or rework need to be completed within 1 year.

### C. Control for unfinished reel

- For any unuse LEDs, they need to be stored in sealed MBB with desiccant or desiccator at <5%RH.

### D. Control of assembled boards

- If the PCB soldered with the LEDs is to be subjected to other high temperature processes, the PCB need to be stored in sealed MBB with desiccant or desiccator at <5%RH to ensure no LEDs have exceeded their floor life of 1 year.

### E. Baking is required if:

- 60% HIC indicator is NOT blue.
- The LEDs are exposed to condition of >30°C / 60% RH at any time.
- The LEDs floor life exceeded 1 year.

Recommended baking condition: 60±5°C for 20 hours.

## Device Color (X<sub>1</sub>)

W	Cool White
Y	Warm White

## Flux Bin (X<sub>2</sub>X<sub>3</sub>)

Individual reel will contain parts from one bin only.

X <sub>2</sub>	Min Flux Bin
X <sub>3</sub>	Max Flux Bin

Bin	Min (lm)	Max (lm)
A	18.1	23.5
B	23.5	30.6
C	30.6	35.2
D	35.2	39.8
E	39.8	45.7
F	45.7	51.7
G	51.7	56.8
H	56.8	62
J	62.0	67.2
K	67.2	73.9

Tolerance ± 12%

## Color Bin (X<sub>4</sub>)

Individual reel will contain parts from one sub bin only.

Bin	Sub Bin
A	1A, 1B, 1C, 1D
B	2A, 2B, 2C, 2D
C	3A, 3B, 3C, 3D
D	4A, 4B, 4C, 4D
E	5A, 5B, 5C, 5D
F	6A, 6B, 6C, 6D
G	7A, 7B, 7C, 7D
H	8A, 8B, 8C, 8D
J	9A, 9B, 9C, 9D
K	1A, 1B, 1C, 1D, 2A, 2B, 2C, 2D
L	2A, 2B, 2C, 2D, 3A, 3B, 3C, 3D
M	3A, 3B, 3C, 3D, 4A, 4B, 4C, 4D
N	4A, 4B, 4C, 4D, 5A, 5B, 5C, 5D
P	5A, 5B, 5C, 5D, 6A, 6B, 6C, 6D
R	7A, 7B, 7C, 7D, 8A, 8B, 8C, 8D
S	8A, 8B, 8C, 8D, 9A, 9B, 9C, 9D
O	1A, 1B, 1C, 1D, 2A, 2B, 2C, 2D, 3A, 3B, 3C, 3D, 4A, 4B, 4C, 4D, 5A, 5B, 5C, 5D, 6A, 6B, 6C, 6D
1	7A, 7B, 7C, 7D, 8A, 8B, 8C, 8D, 9A, 9B, 9C, 9D

Sub Bin	Chromaticity Coordinates				
1A	x	0.2950	0.2920	0.2984	0.3009
	y	0.2970	0.3060	0.3133	0.3042
1B	x	0.2920	0.2895	0.2962	0.2984
	y	0.3060	0.3135	0.3220	0.3133
1C	x	0.2984	0.2962	0.3028	0.3048
	y	0.3133	0.3220	0.3304	0.3207
1D	x	0.2984	0.3048	0.3068	0.3009
	y	0.3133	0.3207	0.3113	0.3042
2A	x	0.3048	0.3130	0.3144	0.3068
	y	0.3207	0.3290	0.3186	0.3113
2B	x	0.3028	0.3115	0.3130	0.3048
	y	0.3304	0.3391	0.3290	0.3207
2C	x	0.3115	0.3205	0.3213	0.3130
	y	0.3391	0.3481	0.3373	0.3290
2D	x	0.3130	0.3213	0.3221	0.3144
	y	0.3290	0.3373	0.3261	0.3186
3A	x	0.3215	0.3290	0.3290	0.3222
	y	0.3350	0.3417	0.3300	0.3243
3B	x	0.3207	0.3290	0.3290	0.3215
	y	0.3462	0.3538	0.3417	0.3350
3C	x	0.3290	0.3376	0.3371	0.3290
	y	0.3538	0.3616	0.3490	0.3417
3D	x	0.3290	0.3371	0.3366	0.3290
	y	0.3417	0.3490	0.3369	0.3300



**Color Bin (X<sub>4</sub>) (continued)**

<b>Sub Bin</b>	<b>Chromaticity Coordinates</b>				
4A	x	0.3371	0.3451	0.3440	0.3366
	y	0.3490	0.3554	0.3427	0.3369
4B	x	0.3376	0.3463	0.3451	0.3371
	y	0.3616	0.3687	0.3554	0.3490
4C	x	0.3463	0.3551	0.3533	0.3451
	y	0.3687	0.3760	0.3620	0.3554
4D	x	0.3451	0.3533	0.3515	0.3440
	y	0.3554	0.3620	0.3487	0.3427
5A	x	0.3530	0.3615	0.3590	0.3512
	y	0.3597	0.3659	0.3521	0.3465
5B	x	0.3548	0.3641	0.3615	0.3530
	y	0.3736	0.3804	0.3659	0.3597
5C	x	0.3641	0.3736	0.3702	0.3615
	y	0.3804	0.3874	0.3722	0.3659
5D	x	0.3615	0.3702	0.3670	0.3590
	y	0.3659	0.3722	0.3578	0.3521
6A	x	0.3670	0.3702	0.3825	0.3783
	y	0.3578	0.3722	0.3798	0.3646
6B	x	0.3702	0.3736	0.3869	0.3825
	y	0.3722	0.3874	0.3958	0.3798
6C	x	0.3825	0.3869	0.4006	0.3950
	y	0.3798	0.3958	0.4044	0.3875
6D	x	0.3783	0.3825	0.3950	0.3898
	y	0.3646	0.3798	0.3875	0.3716
7A	x	0.3889	0.3941	0.4080	0.4017
	y	0.3690	0.3848	0.3916	0.3751
7B	x	0.3941	0.3996	0.4146	0.4080
	y	0.3848	0.4015	0.4089	0.3916
7C	x	0.4080	0.4146	0.4299	0.4221
	y	0.3916	0.4089	0.4165	0.3984
7D	x	0.4017	0.4080	0.4221	0.4147
	y	0.3751	0.3916	0.3984	0.3814
8A	x	0.4147	0.4221	0.4342	0.4259
	y	0.3814	0.3984	0.4028	0.3853
8B	x	0.4221	0.4299	0.4430	0.4342
	y	0.3984	0.4165	0.4212	0.4028
8C	x	0.4342	0.4430	0.4562	0.4465
	y	0.4028	0.4212	0.4260	0.4071
8D	x	0.4259	0.4342	0.4465	0.4373
	y	0.3853	0.4028	0.4071	0.3893
9A	x	0.4373	0.4465	0.4582	0.4483
	y	0.3893	0.4071	0.4099	0.3919
9B	x	0.4465	0.4562	0.4687	0.4582
	y	0.4071	0.4260	0.4289	0.4099
9C	x	0.4582	0.4687	0.4813	0.4700
	y	0.4099	0.4289	0.4319	0.4126
9D	x	0.4483	0.4582	0.4700	0.4593
	y	0.3919	0.4099	0.4126	0.3944

Tolerance ±0.01

## Color Bin

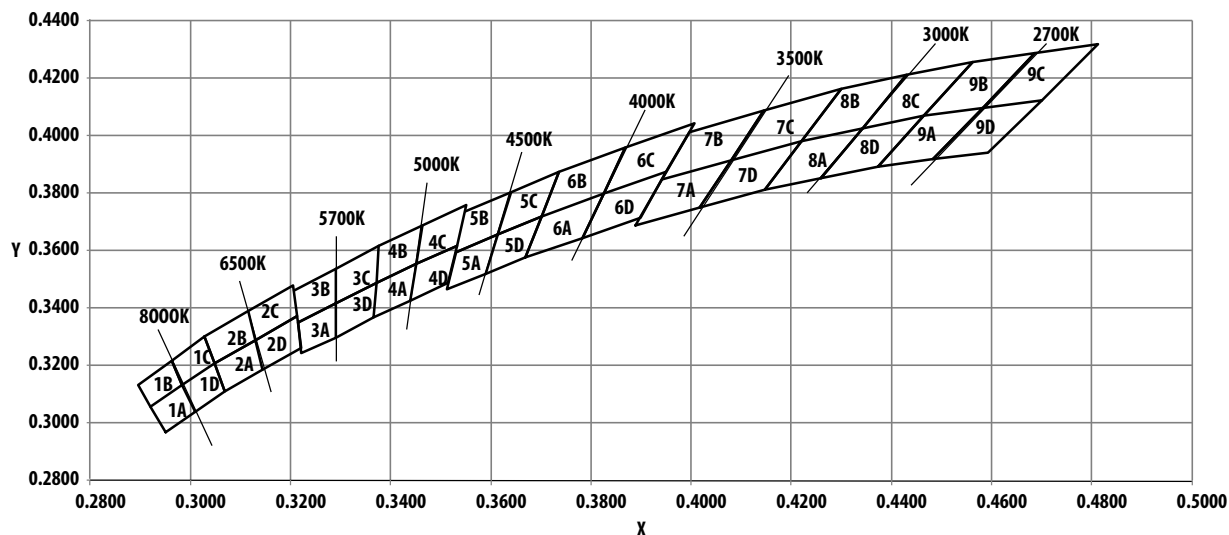

Figure 13. Color Bin

### Packaging Option (X<sub>5</sub>)

Option	Test Current	Package Type	Reel Size
8	80 mA	Top Mount	7 Inch

### Forward Voltage Bin

Bin	Min (V)	Max (V)
F05	2.8	3.0
F06	3.0	3.2
F07	3.2	3.4

Tolerance  $\pm 0.1$  V

**DISCLAIMER:** Avago's products and software are not specifically designed, manufactured or authorized for sale as parts, components or assemblies for the planning, construction, maintenance or direct operation of a nuclear facility or for use in medical devices or applications. Customer is solely responsible, and waives all rights to make claims against avago or its suppliers, for all loss, damage, expense or liability in connection with such use.

For product information and a complete list of distributors, please go to our web site: [www.avagotech.com](http://www.avagotech.com)

Avago, Avago Technologies, and the A logo are trademarks of Avago Technologies in the United States and other countries. Data subject to change. Copyright © 2005-2014 Avago Technologies. All rights reserved. AV02-3369EN - February 18, 2014

**Avago**  
TECHNOLOGIES