

NCP1351ADAPGEVB

NCP1351 57 W Adapter Evaluation Board User's Manual



ON Semiconductor®

<http://onsemi.com>

EVAL BOARD USER'S MANUAL

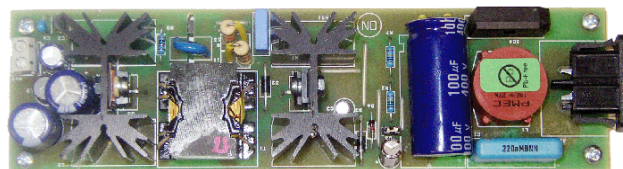

Figure 1. Evaluation Board Photo

The NCP1351 at a Glance

Fixed t_{on} , variable t_{off} current-mode control: implementing a fixed peak current mode control (hence the more appropriate term “quasi-fixed” t_{on}), the NCP1351 modulates the off time duration according to the output power demand. In high power conditions, the switching frequency increases until a maximum is hit. This upper limit depends on an external capacitor selected by the designer. In light load conditions, the off time expands and the NCP1351 operates at a lower frequency. As the frequency reduces, the contribution of all frequency-dependent losses accordingly goes down (driver current, drain capacitive losses, switching losses), naturally improving the efficiency at various load levels.

Peak Current Compression at Light Loads: Reducing the frequency will certainly force the converter to operate into the audible region. To prevent the transformer mechanical resonance, the NCP1351 gradually reduces – compresses – the peak current setpoint as the load becomes lighter. When the current reaches 30% of the nominal value, the compression stops and the off duration keeps expanding towards low frequencies.

Low Standby-power: the frequency reduction technique offers an excellent solution for designers looking for low standby power converters. Also, compared to the skip-cycle method, the smooth off time expansion does not bring additional ripple in no-load conditions: the output voltage remains quiet.

Natural Frequency Dithering: the quasi-fixed t_{on} mode of operation improves the EMI signature since the switching frequency varies with the natural bulk ripple voltage.

Extremely Low Start-up Current: built on a proprietary circuitry, the NCP1351 startup section does not consume more than 10 μ A during the startup sequence. The designer can thus easily combine startup time and standby consumption.

Overload Protection Based on Fault Timer: every designer knows the pain of building converters where a precise over current limit must be obtained. When the fault detection relies on the auxiliary V_{CC} , the pain even increases. Here, the NCP1351 observes the lack of feedback current starts a timer to countdown. At the end of its charge, the timer either triggers an auto-recovery sequence (auto-restart, B version) or permanently latches-off (A).

Latch Fault Input: a dedicated input lets the designer externally trigger the latch to build additional protections such as over-voltage (OVP) or over-temperature (OTP).

The Schematic

The design must fulfil the following specifications:

Input voltage: 90 – 265 Vac

Output voltage: 19 V @ 3 A

Over voltage protection

Over power protection

Auto-recovery short-circuit protection

Offering a good EMI signature, the 65 kHz maximum switching frequency has become an industry standard for the vast majority of power supplies connected on the mains. With the NCP1351, selecting a C_t capacitor of 270 pF fixes the upper limit to 65 kHz. As a result, when the controller detects a need for a higher frequency, implying an overload condition, it will start to charge the timer capacitor: if the overload disappears, the timer capacitor goes back to zero. If the fault remains, the timer capacitor voltage reaches 5 V and starts the auto-recovery process.

The transformer has been derived using the design recommendations described in the NCP1351 data-sheet. We came-up to the following values:

$$L_p = 770 \mu\text{H}$$

$$N_p:N_s = 1:0.25$$

$$N_p:N_{aux} = 1:0.18$$

It is also possible to use the Excel® spreadsheet available from the ON Semiconductor website which also gives transformer parameters. The core is a PQ26x25 made of a 3F3 material and has been manufactured by Delta Electronics (reference 86H-6232). The leakage inductance is kept around 1%, leading to a good efficiency and reduced losses in no-load conditions. The schematic appears on Figure 3. The converter operates in CCM with a 40% duty-cycle at low mains and stays CCM at high line. Despite

NCP1351ADAPGEVB

the frequency variation, it is possible to evaluate the input voltage point at which the converter leaves CCM:

$$V_{in, crit} = \frac{2P_{out}V_{out}}{I_{peak}V_{out}\eta - 2NP_{out}} = \frac{2 \times 57 \times 19}{2 \times 19 \times 0.9 - 2 \times 0.25 \times 57} = 380 \text{ Vdc} \quad (\text{eq. 1})$$

Where:

I_{peak} is the selected peak current in the inductor

V_{out} , the output voltage

η , the converter efficiency

P_{out} , the delivered power

N , the transformer turn ratio, $N_p:N_s = 1:N$

Since we are limited to 265 Vac, we can see that the converter will always be in CCM at full power. To the opposite, we can also predict the power level at which the converter leaves CCM at low and high line conditions:

$$P_{out, crit} = \frac{\eta I_{peak} V_{in} V_{out}}{V_{out} + N V_{in}} \quad (\text{eq. 2})$$

For an input voltage of 120 Vdc, the converter enters DCM for an output power below 42 W. When the voltage increases to 330 Vdc, the power level at which CCM is excited is 55 W.

Two 1 M Ω resistors ensure a clean start-up sequence with the 4.7 μ F capacitor (C_3), directly from the bulk capacitor. Despite a small value for C_3 , the V_{CC} still maintains in no-load conditions thanks to the split configuration:

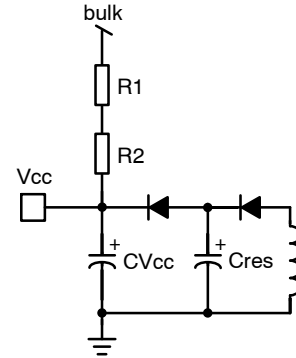

Figure 2.

The split V_{CC} configuration helps to start-up in a small period of time (CV_{CC} to charge alone) but the addition of a second, larger capacitor (C_{res}), ensures enough V_{CC} in standby.

The primary-side feedback current is fixed to roughly 300 μ A via R_5 and an additional bias is provided for the TL431. 1 mA at least must flow in the TL431 in worse case conditions (full load). Failure to respect this will degrade the power supply output impedance and regulation will suffer. A 1.5 k Ω has proven to do just well, without degrading the standby power.

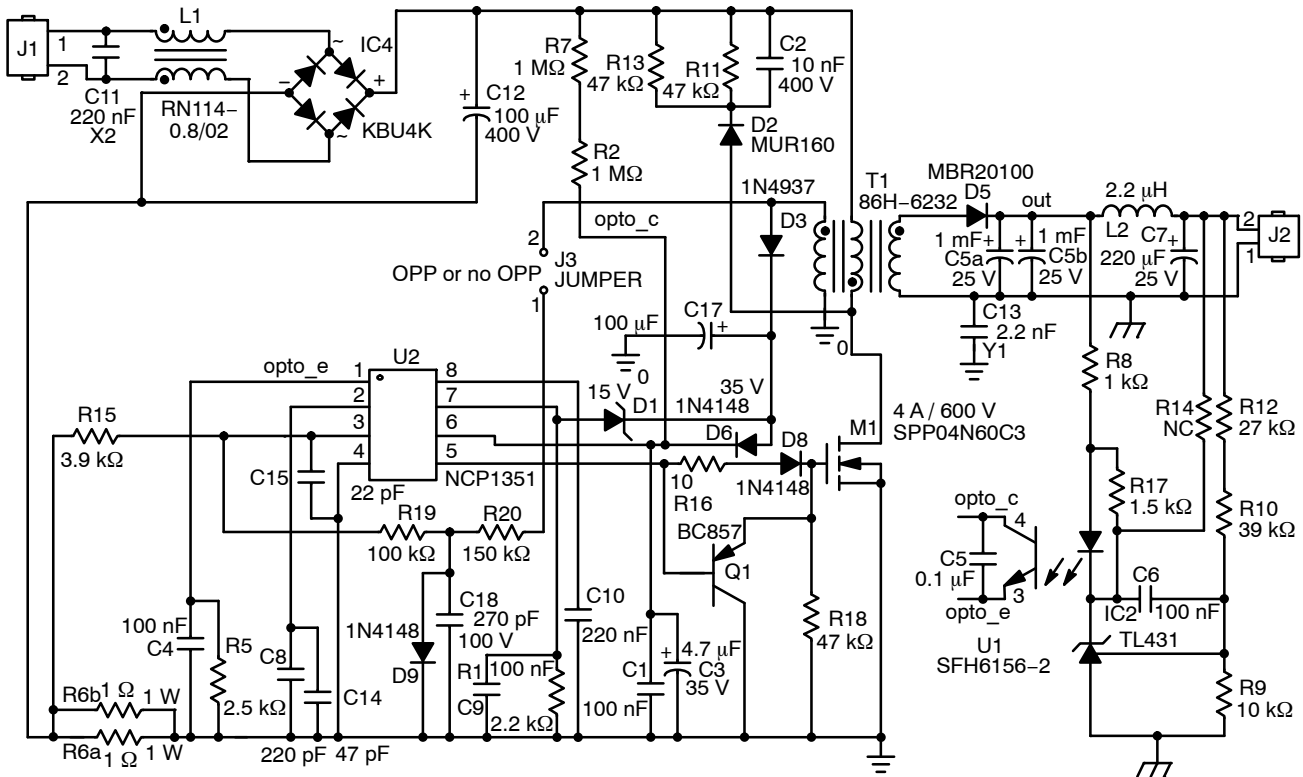

Figure 3. The 57 W Adapter Board Featuring the NCP1351 Controller

NCP1351ADAPGEVB

The overvoltage protection uses a 15 V zener diode (D₁) connected to the auxiliary V_{CC}. When the voltage on this rail exceeds 15 V plus the NCP1351 5 V latch trip point (total is thus 20 V), the circuit latches-off and immediately pulls the V_{CC} pin down to 6 V. The reset occurs when the injected current into the V_{CC} pin passes below a few μ A, that is to say when the power supply is disconnected from the mains

outlet. To speed-up this reset phase, a connection via a diode to the half-wave point will reset the circuit faster (Figure 4). Please note that the half-wave resistor equals the original bulk start-up resistor divided by 3.14. This provides the same startup current, despite the half-wave signal. The power dissipation is also slightly reduced (by 30% roughly).

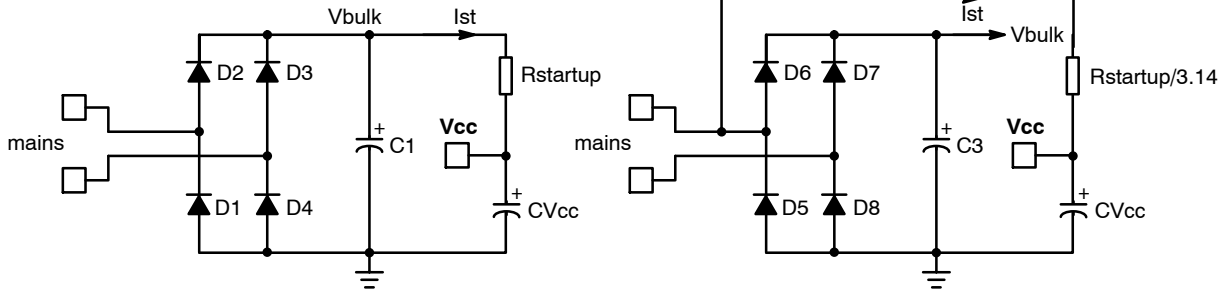

Figure 4.

Connecting the startup resistor to the mains before the diode bridge helps to speed-up the NCP1351 reset time when latched.

To satisfy the maximum power limit, we can install an Over Power Protection (OPP) circuit. Given the negative sensing technique, we can use a portion of the auxiliary signal during the on time, as it also swings negative. However, we need this compensation at high line only since standby power can be affected. For this reason, we have installed a small integrator made of C₁₈-R₂₀. To avoid charging C₁₈ during the flyback stroke, D₉ clamps the

positive excursion and offers a stronger negative voltage during the on time.

Finally, the clamping network maintains the drain voltage below 520 V at high-line (375 Vdc) which provides 85% derating for the 600 V BV_{dss} device.

Measurements

Once assembled, the board has been operated during 15 mn at full power to allow some warm-up time. We used a WT210A from Yokogawa to perform all power related measurements coupled to an electronic ac source.

EFFICIENCY

V _{IN} (P _{OUT})	110 Vac	230 Vac
57 W	89.8%	91.2%
30 W	90%	91%
10 W	89%	88.5%
1 W	72%	68.3%
0.5 W	60.7%	58%

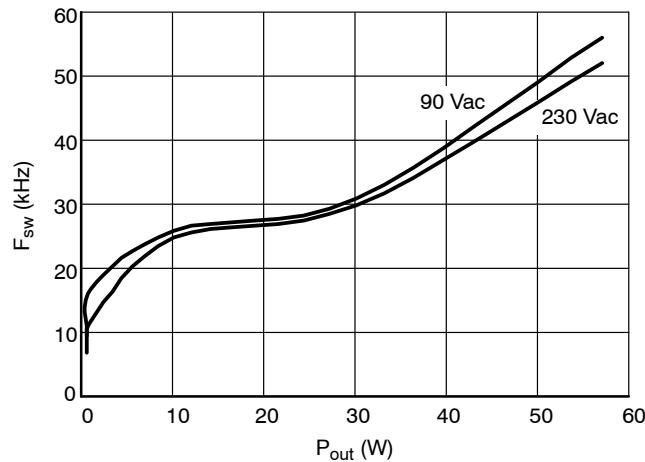

Figure 5. Switching Frequency F_{sw} vs. P_{out}

NCP1351ADAPGEVB

V_{IN} (P _{OUT})	110 Vac	230 Vac
0.5 Output Power		
0.5 W	833 mW	865 mW
No-load Power		
No-load	112 mW	139 mW
Overpower Protection Level		
V_{IN} (P _{OUT})	90 Vac	265 Vac
Overpower	3.2 A	4.1 A
Start-up Time		
V_{IN} (I _{OUT} = 3 A)	90 Vac	230 Vac
Start-up Duration	1.5 s	0.5 s

On the above arrays, we can see the excellent efficiency at different loading conditions. The first explanation is the low leakage inductance on the tested transformer (below 1% of the primary inductance). Also, the frequency reduction in lighter load configurations helps for the switching losses. The no-load standby power stays below 150 mW at high line, a good performance for a 60 W adapter. Please note that the high-voltage probe observing the drain was removed and the load totally disconnected to avoid leakage. The OPP proves to work ok. Perhaps an improved margin would help

at 90 Vac, which could be obtained by slightly increasing R₁₉ or, if necessary, by increasing R₁₅.

Despite operation in the audible range, we did not notice any noise problems coming from either the transformer or the RCD clamp capacitor.

Scope shots

Below are some oscilloscope shots gathered on the demoboard:

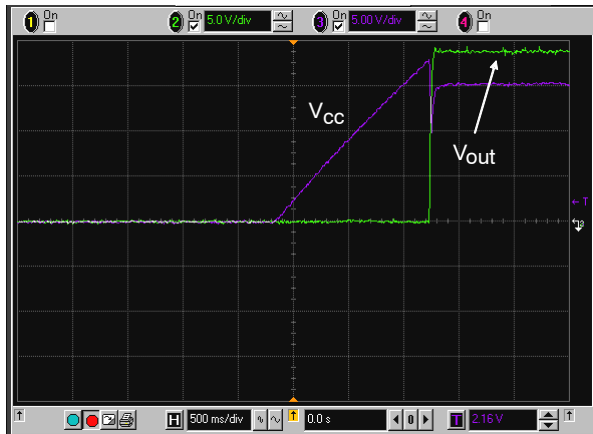

Figure 6. Startup time, $V_{in} = 90$ Vac

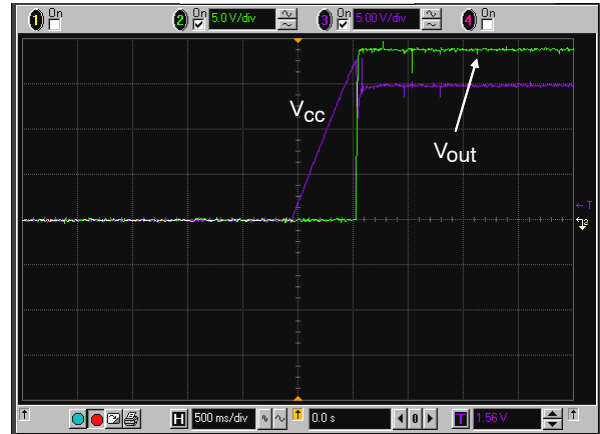

Figure 7. Startup time, $V_{in} = 230$ Vac

NCP1351ADAPGEVB

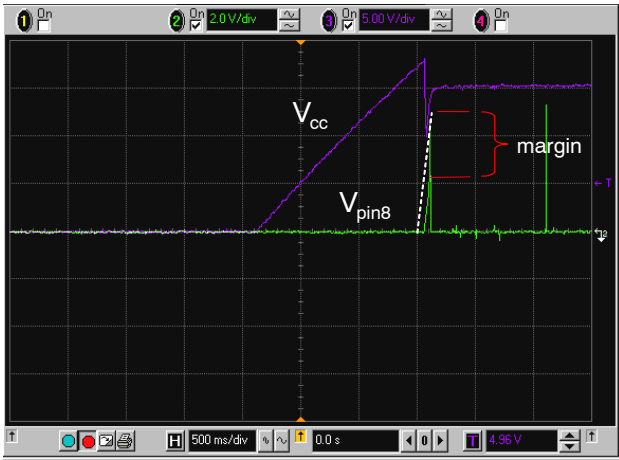

Figure 8. Startup Sequence to Test the Margin on the 100 ms Timer. $V_{in} = 90 \text{ Vac}$ $I_{out} = 3 \text{ A}$

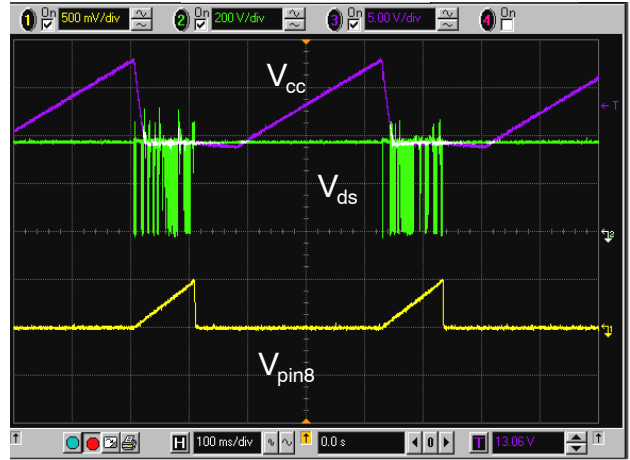

Figure 9. Short-circuit, $V_{in} = 265 \text{ Vac}$

On the above picture, a short-circuit has been made at the highest line voltage. During the burst operation, the input power was maintained to 6.3 W at 275 Vac. It dropped to 5.2 W at 230 Vac.

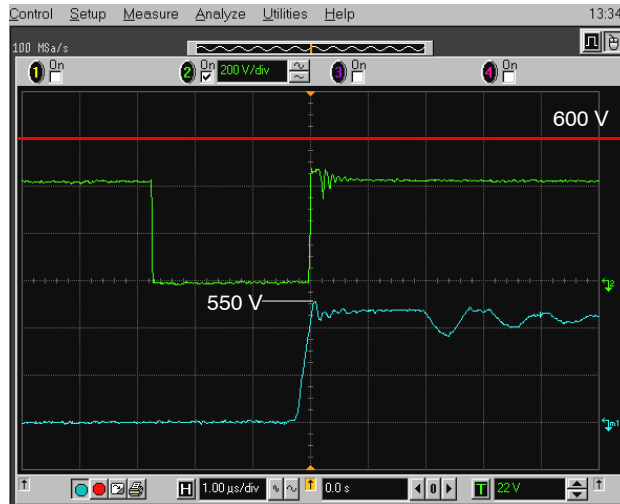

Figure 10. Maximum Output Power, $V_{in} = 265 \text{ Vac}$
Note the good margin on the drain thanks to the low leakage term

NCP1351ADAPGEVB

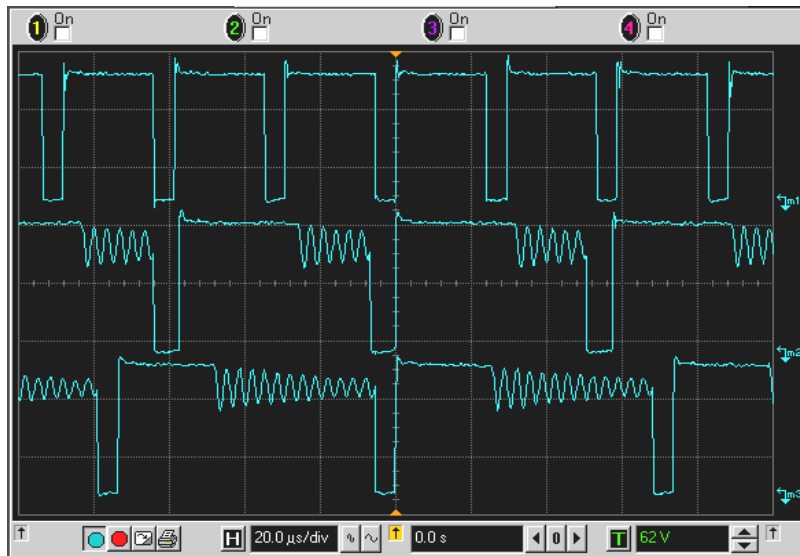

Figure 11. The Drain–source Waveform at Different Output Currents (3 A, 2 A and 1 A). The Input Voltage is 230 Vac

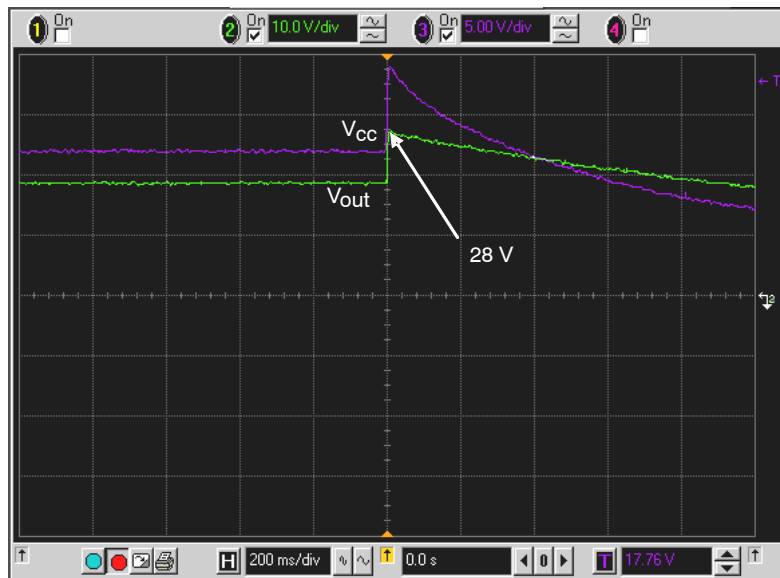

Figure 12. Short-circuit on the Optocoupler LED

The output voltage increases to 28 V and then the controller latches-off. Different levels can be obtained by changing D_1 .

NCP1351ADAPGEVB

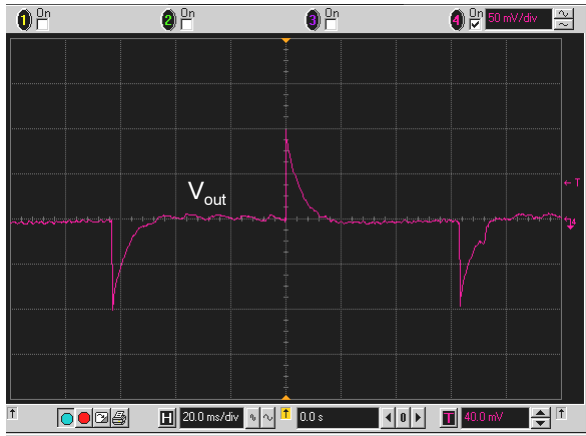

Figure 13. Load Step from 0.5 A to 3 A with a 1 A / μ s Slew-rate from a 90 Vac

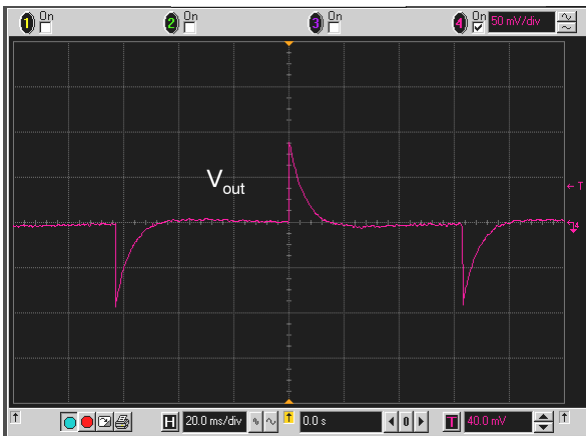

Figure 14. Load Step from 0.5 A to 3 A with a 1 A / μ s Slew-rate from a 230 Vac source

Conclusion

The adapter built with the NCP1351 exhibits an excellent performance on several parameters like the efficiency and the no-load standby. The OPP is made in a simple non-dissipative way and does not hamper the standby power. The limited number of surrounding components around the controller associated to useful features (timer-based protection, latch input...) makes the NCP1351 an excellent choice for cost-sensitive adapter designs.

NCP1351ADAPGEVB

BILL OF MATERIALS FOR THE NCP1351ADAPGEVB

Designator	Qty	Description	Value	Tolerance	Footprint	Manufacturer	Manufacturer Part Number	Substitution Allowed	Lead Free
C1, C4, C5, C9	3	SMD capacitor	100 nF/50 V	5%	SMD 1206	PHYCOMP	2238 581 15649	yes	yes
C2	1	capacitor	10 nF/630 V	10%	radial	Vishay	2222 372 61103	yes	yes
C3	1	electrolytic capacitor	4.7 μ F/50 V	20%	radial	Panasonic	ECA1HM4R7	yes	yes
C5b, C5a	2	electrolytic capacitor	1000 μ F/35 V	20%	radial	Panasonic	EEUFC1V102	no	yes
C6	1	capacitor	100 nF/50 V	10%	radial	AVX	SR215C104KTR	yes	yes
C7	1	electrolytic capacitor	220 μ F/25 V	20%	radial	Panasonic	EEUFC1E221	yes	yes
C8	1	SMD capacitor	220 pF/50 V	5%	SMD 1206	PHYCOMP	2238 863 15471	yes	yes
C10	1	SMD capacitor	220 nF/50 V	10%	SMD 1206	AVX	CM316X7R224K50AT	yes	yes
C11	1	X2 capacitor	220 nF/630 V	20%	radial	Evov Rifa	PHE840MD6220M	yes	yes
C12	1	electrolytic capacitor	100 μ F/400 V	20%	radial	Panasonic	ECA2GM101	yes	yes
C13	1	Y1 capacitor	2.2 nF/250 V	20%	radial	Ceramite	440LD22	yes	yes
C14	1	SMD capacitor	47 pF/50 V	5%	SMD 1206	PHYCOMP	2238 863 15479	yes	yes
C15	1	SMD capacitor	22 pF/50 V	5%	SMD 1206	PHYCOMP	2238 863 15229	yes	yes
C17	1	electrolytic capacitor	100 μ F/35 V	20%	radial	Panasonic	ECA1VM101	yes	yes
C18	1	SMD capacitor	270 pF/50 V	5%	SMD 0805	PHYCOMP	2238 861 15271	yes	yes
D1	1	zener diode	15 V/225 mW	5%	SOT23	ON Semiconductor	BZX84C15LT1G	yes	yes
D2	1	ultrafast rectifier	1 A/600 V	0%	axial	ON Semiconductor	MUR160G	yes	yes
D3	1	high-speed diode	1 A/600 V	0%	axial	ON Semiconductor	1N4937G	yes	yes
D5	1	schottky diode	20 A/100 V	0%	TO220	ON Semiconductor	MBR20100CTG	yes	yes
D6	1	high-speed diode	0.2 A/75 V	0%	axial	Philips Semiconductor	1N4148	yes	yes
D8,D9	1	high-speed diode	0.2 A/100 V	0%	SOD-123	ON Semiconductor	MMSD4148G	yes	yes
HS1, HS2	2	heatsink	6.2 $^{\circ}$ C/W	0%	radial	Seifert	KL195/25.4/SWI	yes	yes
IC2	1	shunt regulator	2.5-36 V/ 1-100 mA	2%	TO92	ON Semiconductor	TL431ILPG	yes	yes
IC4	1	diode bridge	4 A/800 V	0%	radial	Multicomp	KBU4K	yes	yes
J1	1	connector	230 Vac/	0%	radial	Schurter	0721-PP	yes	yes
J2	1	connector	2"	0%	rad5.08mm	Weidmuller	PM5.08/2/90	yes	yes
L1	1	Common mode	2*27 mH/0.8 A	0%	radial	Schaffner	RN114-0.8/02	yes	yes
L2	1	Inductor	2.2 μ H/10 A	0%	radial	Würth Elektronik	744772022	yes	yes
M1	1	power MOSFET N-Channel	4 A/600 V	0%	TO220	Infineon	SPP04N60C3	yes	yes
Q1	1	PNP transistor	-100 mA/-45 V	0%	TO92	ON Semiconductor	BC857	yes	yes
R1	1	SMD resistor	2.2 k Ω /0.25 W	1%	SOT23	Welwyn	WCR12062K22%	yes	yes
R2, R7	2	resistor	1 M Ω /0.33 W	5%	axial	Vishay	SFR2500001004JR500	yes	yes
R5	1	SMD resistor	2.5 k Ω /0.25 W	2%	SMD 1206	Welwyn	WCR12062K52%	yes	yes
R6b, R6a	2	SMD resistor	1 Ω /1 W	5%	SMD 2512	PHYCOMP	232276260108	yes	yes
R8	1	resistor	1 k Ω /0.4 W	5%	axial	Vishay	SFR2500001001JR500	yes	yes
R9	1	SMD resistor	10 k Ω /0.25 W	2%	SMD 1206	Welwyn	WCR120610K2%	yes	yes
R10	1	SMD resistor	39 k Ω /0.25 W	2%	SMD 1206	Welwyn	WCR120639K2%	yes	yes
R11, R13	2	resistor	47 k Ω /2 W	5%	axial	Multicomp	MCF2W47K	yes	yes
R12	1	SMD resistor	27 k Ω /0.25 W	2%	SMD 1206	Welwyn	WCR120627K2%	yes	yes

NCP1351ADAPGEVB

BILL OF MATERIALS FOR THE NCP1351ADAPGEVB

Designator	Qty	Description	Value	Tolerance	Footprint	Manufacturer	Manufacturer Part Number	Substitution Allowed	Lead Free
R14	1	SMD resistor	NC					yes	yes
R15	1	SMD resistor	5.1 k Ω /0.25 W	2%	SMD 1206	Welwyn	WCR12063K92%	yes	yes
R16	1	SMD resistor	10 Ω /0.25 W	2%	SMD 1206	Welwyn	WCR120610R2%	yes	yes
R17	1	SMD resistor	1.5 k Ω /0.25 W	2%	SMD 1206	Welwyn	WCR12061K52%	yes	yes
R18	1	SMD resistor	47 k Ω /0.25 W	2%	SMD 1206	Welwyn	WCR120647K2%	yes	yes
R19	1	SMD resistor	100 k Ω /0.25 W	2%	SMD 1206	Welwyn	WCR1206100K2%	yes	yes
R20	1	SMD resistor	150 k Ω /0.25 W	2%	SMD 1206	Welwyn	WCR1206150K2%	yes	yes
TP1, TP2, TP3, TP4	4	pcb foot	T POINT A		FIX 4 H	Richco	LCBS-TF-M4-8-01	yes	yes
T1	1	Transformer	86H-6232		radial	Delta	86H-6232	no	yes
U1	1	optocoupler	sfh6156/		SMD	Vishay	SFH6156-2T	no	yes
U2	1	CMOS IC	NCP1351B		SO-8	ON Semiconductor	NCP1351B	no	yes

NOTE: Screws, nuts, and washers attached to heatsinks MUST be non-conductive (Nylon).

TEST PROCEDURE FOR THE NCP1351 ADAPTER EVALUATION BOARD

NOTE: Be careful when manipulating the boards in operation, lethal voltages up to 400 V are present on the primary side. An isolation transformer is also recommended for safer manipulations.

Necessary Equipment

- 1 Current limited 90 \pm 265 Vrms AC source (current limited to avoid board destruction in case of a defective part) or a 380 VDC source (AGILENT 6811)
- 1 AC Volt-Meter able to measure up to 300 V AC. (KEITHLEY 2000)
- 1 AC Amp-Meter able to measure up to 3 A AC. (KEITHLEY 2000)
- 1 DC Volt-Meter able to measure up to 20 V DC. (KEITHLEY 2000)

- 1 DC Amp-Meter able to measure up to 5 A DC. (KEITHLEY 2000)
- 1 DC Electronic Load 0 – 4 A (AGILENT 6060B)

Test Procedure

1. Apply 90 \pm 230 V AC over the Vin pins. Output pins (+Vout (+), Ground (-)) are left floating.
2. Measure the output voltage between pins +Vout et Ground with a volt-meter on the auto range. The measurement should be between 18.8 and 19.2 V.
3. Connect the electronic load between pin +Vout et Ground. Verify that the output voltage stays above 19 V. Set current 3 A.
4. If every step is going well, the board is considered to be ok.



AC/DC 19 V – 3 A adapter

Figure 15. Test Setup

NCP1351ADAPGEVB

PCB layout

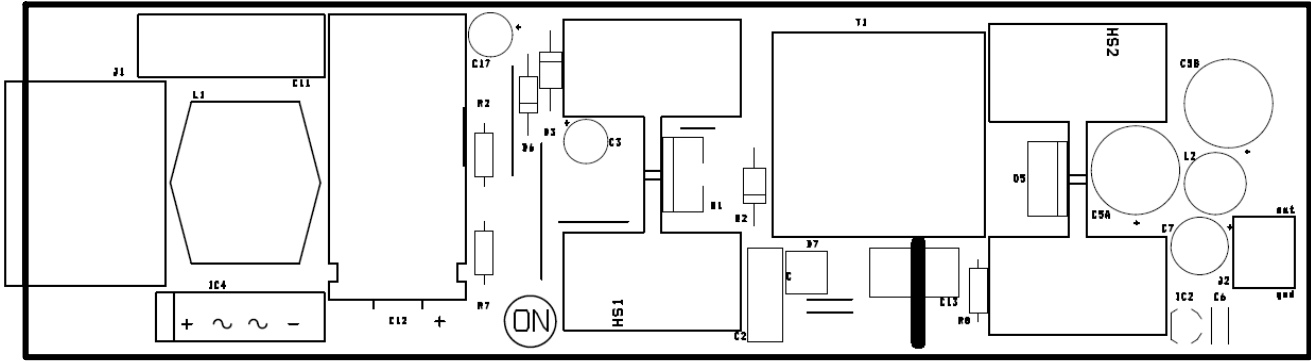

Figure 16. Top Side Components

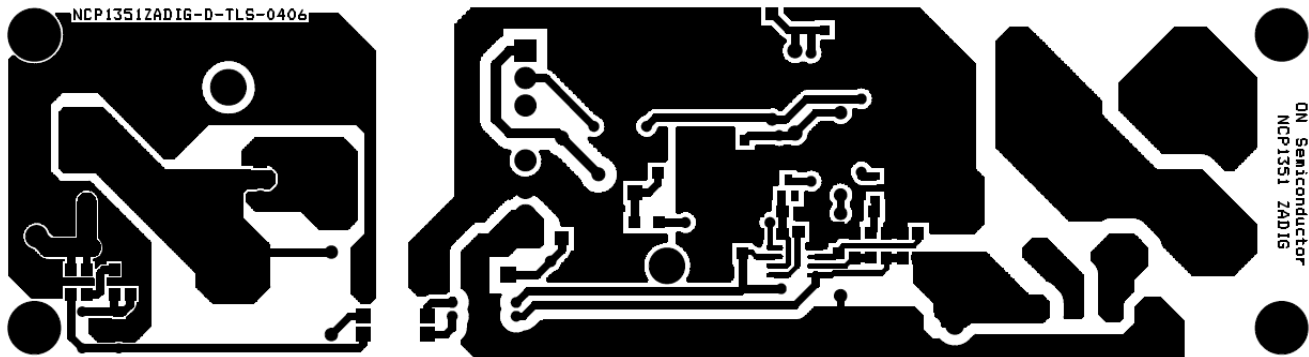

Figure 17. Copper Traces

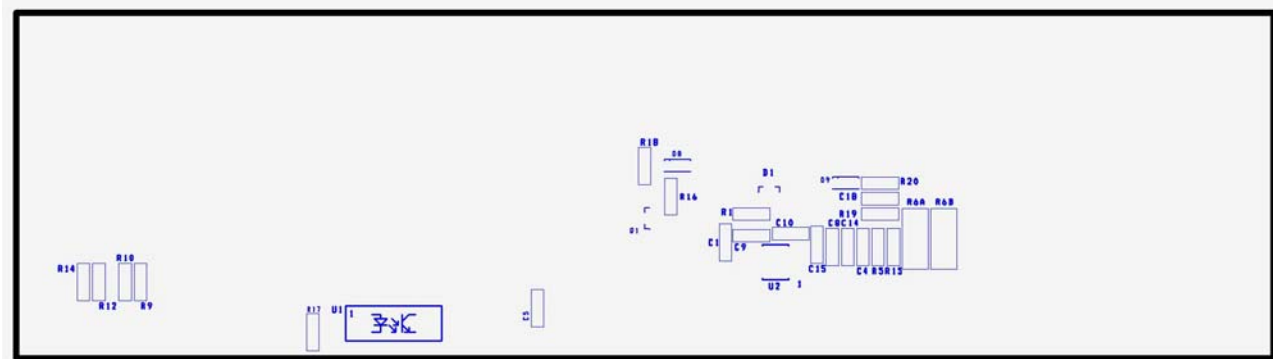

Figure 18. SMD components

ON Semiconductor and **ON** are registered trademarks of Semiconductor Components Industries, LLC (SCILLC). SCILLC owns the rights to a number of patents, trademarks, copyrights, trade secrets, and other intellectual property. A listing of SCILLC's product/patent coverage may be accessed at www.onsemi.com/site/pdf/Patent-Marking.pdf. SCILLC reserves the right to make changes without further notice to any products herein. SCILLC makes no warranty, representation or guarantee regarding the suitability of its products for any particular purpose, nor does SCILLC assume any liability arising out of the application or use of any product or circuit, and specifically disclaims any and all liability, including without limitation special, consequential or incidental damages. "Typical" parameters which may be provided in SCILLC data sheets and/or specifications can and do vary in different applications and actual performance may vary over time. All operating parameters, including "Typicals" must be validated for each customer application by customer's technical experts. SCILLC does not convey any license under its patent rights nor the rights of others. SCILLC products are not designed, intended, or authorized for use as components in systems intended for surgical implant into the body, or other applications intended to support or sustain life, or for any other application in which the failure of the SCILLC product could create a situation where personal injury or death may occur. Should Buyer purchase or use SCILLC products for any such unintended or unauthorized application, Buyer shall indemnify and hold SCILLC and its officers, employees, subsidiaries, affiliates, and distributors harmless against all claims, costs, damages, and expenses, and reasonable attorney fees arising out of, directly or indirectly, any claim of personal injury or death associated with such unintended or unauthorized use, even if such claim alleges that SCILLC was negligent regarding the design or manufacture of the part. SCILLC is an Equal Opportunity/Affirmative Action Employer. This literature is subject to all applicable copyright laws and is not for resale in any manner.

PUBLICATION ORDERING INFORMATION

LITERATURE FULFILLMENT:
Literature Distribution Center for ON Semiconductor
P.O. Box 5163, Denver, Colorado 80217 USA
Phone: 303-675-2175 or 800-344-3860 Toll Free USA/Canada
Fax: 303-675-2176 or 800-344-3867 Toll Free USA/Canada
Email: orderlit@onsemi.com

N. American Technical Support: 800-282-9855 Toll Free
USA/Canada
Europe, Middle East and Africa Technical Support:
Phone: 421 33 790 2910
Japan Customer Focus Center
Phone: 81-3-5817-1050

ON Semiconductor Website: www.onsemi.com
Order Literature: <http://www.onsemi.com/orderlit>
For additional information, please contact your local
Sales Representative