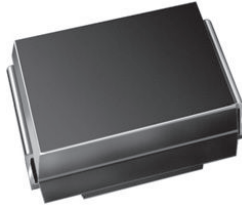


## Surface Mount Ultrafast Plastic Rectifier


**DO-214AA (SMB)**

PRIMARY CHARACTERISTICS	
$I_{F(AV)}$	2.0 A
$V_{RRM}$	50 V, 100 V, 150 V, 200 V
$I_{FSM}$	50 A
$t_{rr}$	20 ns
$V_F$	0.90 V
$T_J \text{ max.}$	150 °C
Package	DO-214AA (SMB)
Diode variations	Single die

**FEATURES**

- Glass passivated chip junction
- Ideal for automated placement
- Ultrafast recovery times for high efficiency
- Low forward voltage, low power losses
- High forward surge capability
- Meets MSL level 1, per J-STD-020, LF maximum peak of 260 °C
- AEC-Q101 qualified
- Material categorization: For definitions of compliance please see [www.vishay.com/doc?99912](http://www.vishay.com/doc?99912)


**RoHS**  
COMPLIANT

**TYPICAL APPLICATIONS**

For use in high frequency rectification and freewheeling application in switching mode converters and inverters for consumer, computer, automotive, and telecommunication.

**MECHANICAL DATA**

**Case:** DO-214AA (SMB)

Molding compound meets UL 94 V-0 flammability rating  
 Base P/N-E3 - RoHS-compliant, commercial grade  
 Base P/NHE3 - RoHS-compliant, AEC-Q101 qualified

**Terminals:** Matte tin plated leads, solderable per J-STD-002 and JESD 22-B102

E3 suffix meets JESD 201 class 2 whisker test, HE3 suffix meets JESD 201 class 2 whisker test

**Polarity:** Color band denotes cathode end

MAXIMUM RATINGS (TA = 25 °C unless otherwise noted)						
PARAMETER	SYMBOL	ES2A	ES2B	ES2C	ES2D	UNIT
Device marking code		EA	EB	EC	ED	
Maximum repetitive peak reverse voltage	$V_{RRM}$	50	100	150	200	V
Maximum RMS voltage	$V_{RMS}$	35	70	105	140	V
Maximum DC blocking voltage	$V_{DC}$	50	100	150	200	V
Maximum average forward rectified current at $T_L = 110$ °C	$I_{F(AV)}$	2.0				A
Peak forward surge current 8.3 ms single half sine-wave superimposed on rated load	$I_{FSM}$	50				A
Operating junction and storage temperature range	$T_J, T_{STG}$	-55 to +150				°C

ELECTRICAL CHARACTERISTICS (TA = 25 °C unless otherwise noted)								
PARAMETER	TEST CONDITIONS		SYMBOL	ES2A	ES2B	ES2C	ES2D	UNIT
Maximum instantaneous forward voltage	2.0 A		$V_F^{(1)}$	0.90				V
Maximum DC reverse current at rated DC blocking voltage	$T_A = 25\text{ °C}$		$I_R$	10				$\mu\text{A}$
	$T_A = 100\text{ °C}$			350				
Max. reverse recovery time	$I_F = 0.5\text{ A}, I_R = 1.0\text{ A}, I_{rr} = 0.25\text{ A}$		$t_{rr}$	20				ns
Maximum reverse recovery time	$I_F = 2.0\text{ A}, V_R = 30\text{ V}, dl/dt = 50\text{ A}/\mu\text{s}, I_r = 10\% I_{RM}$		$T_J = 25\text{ °C}$	30				ns
			$T_J = 100\text{ °C}$	50				
Maximum stored charge	$I_F = 2.0\text{ A}, V_R = 30\text{ V}, dl/dt = 50\text{ A}/\mu\text{s}, I_r = 10\% I_{RM}$		$T_J = 25\text{ °C}$	10				nC
			$T_J = 100\text{ °C}$	25				
Typical junction capacitance	4.0 V, 1 MHz		$C_J$	18				pF

**Note**

(1) Pulse test: 300 ms pulse width, 1 % duty cycle

THERMAL CHARACTERISTICS (TA = 25 °C unless otherwise noted)						
PARAMETER	SYMBOL	ES2A	ES2B	ES2C	ES2D	UNIT
Typical thermal resistance	$R_{\theta JA}^{(1)}$	75				$^{\circ}\text{C}/\text{W}$
	$R_{\theta JL}^{(1)}$	20				

**Note**

(1) Units mounted on PCB 5.0 mm x 5.0 mm (0.013 mm thick) land areas

ORDERING INFORMATION (Example)				
PREFERRED P/N	UNIT WEIGHT (g)	PREFERRED PACKAGE CODE	BASE QUANTITY	DELIVERY MODE
ES2D-E3/52T	0.096	52T	750	7" diameter plastic tape and reel
ES2D-E3/5BT	0.096	5BT	3200	13" diameter plastic tape and reel
ES2DHE3/52T (1)	0.096	52T	750	7" diameter plastic tape and reel
ES2DHE3/5BT (1)	0.096	5BT	3200	13" diameter plastic tape and reel

**Note**

(1) AEC-Q101 qualified

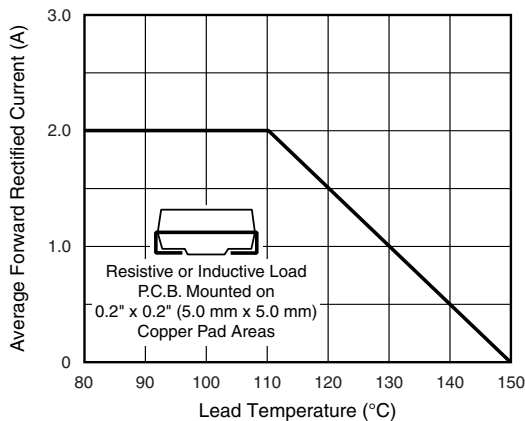
**RATINGS AND CHARACTERISTICS CURVES (TA = 25 °C unless otherwise noted)**


Fig. 1 - Maximum Forward Current Derating Curve

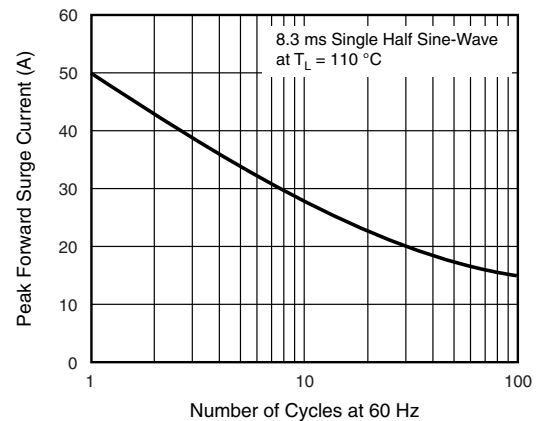


Fig. 2 - Maximum Non-Repetitive Peak Forward Surge Current

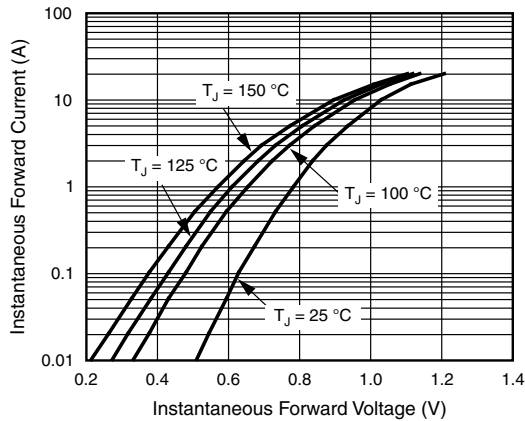


Fig. 3 - Typical Instantaneous Forward Characteristics

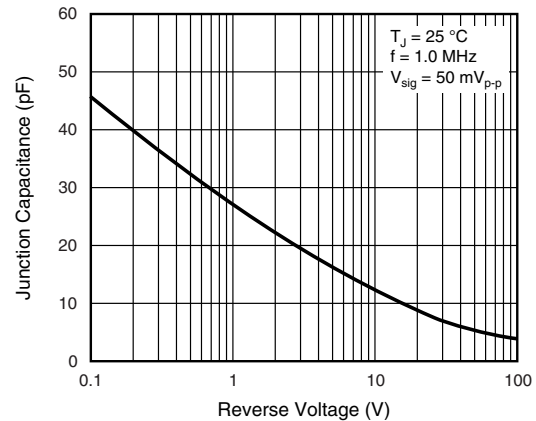


Fig. 5 - Typical Junction Capacitance

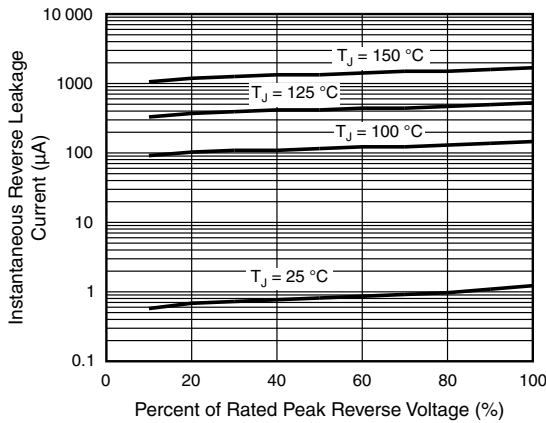
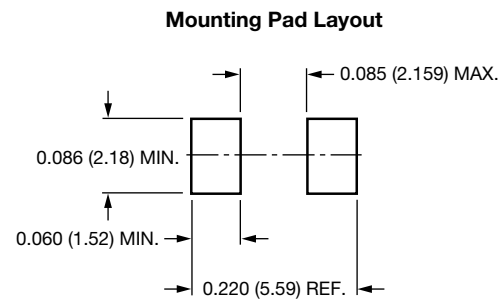
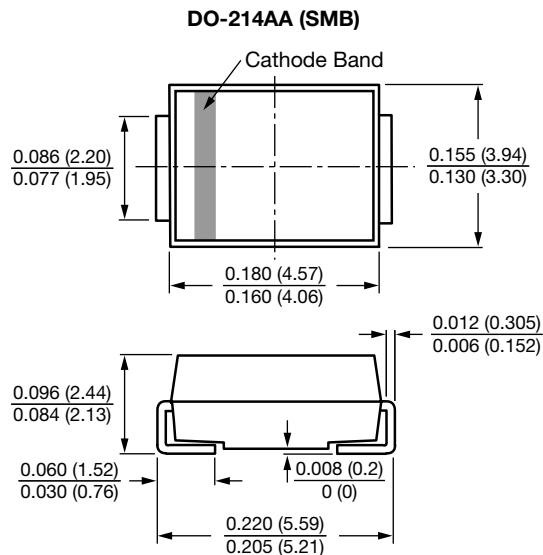


Fig. 4 - Typical Reverse Leakage Characteristics

## PACKAGE OUTLINE DIMENSIONS in inches (millimeters)





## Disclaimer

ALL PRODUCT, PRODUCT SPECIFICATIONS AND DATA ARE SUBJECT TO CHANGE WITHOUT NOTICE TO IMPROVE RELIABILITY, FUNCTION OR DESIGN OR OTHERWISE.

Vishay Intertechnology, Inc., its affiliates, agents, and employees, and all persons acting on its or their behalf (collectively, "Vishay"), disclaim any and all liability for any errors, inaccuracies or incompleteness contained in any datasheet or in any other disclosure relating to any product.

Vishay makes no warranty, representation or guarantee regarding the suitability of the products for any particular purpose or the continuing production of any product. To the maximum extent permitted by applicable law, Vishay disclaims (i) any and all liability arising out of the application or use of any product, (ii) any and all liability, including without limitation special, consequential or incidental damages, and (iii) any and all implied warranties, including warranties of fitness for particular purpose, non-infringement and merchantability.

Statements regarding the suitability of products for certain types of applications are based on Vishay's knowledge of typical requirements that are often placed on Vishay products in generic applications. Such statements are not binding statements about the suitability of products for a particular application. It is the customer's responsibility to validate that a particular product with the properties described in the product specification is suitable for use in a particular application. Parameters provided in datasheets and/or specifications may vary in different applications and performance may vary over time. All operating parameters, including typical parameters, must be validated for each customer application by the customer's technical experts. Product specifications do not expand or otherwise modify Vishay's terms and conditions of purchase, including but not limited to the warranty expressed therein.

Except as expressly indicated in writing, Vishay products are not designed for use in medical, life-saving, or life-sustaining applications or for any other application in which the failure of the Vishay product could result in personal injury or death. Customers using or selling Vishay products not expressly indicated for use in such applications do so at their own risk. Please contact authorized Vishay personnel to obtain written terms and conditions regarding products designed for such applications.

No license, express or implied, by estoppel or otherwise, to any intellectual property rights is granted by this document or by any conduct of Vishay. Product names and markings noted herein may be trademarks of their respective owners.

## Material Category Policy

**Vishay Intertechnology, Inc. hereby certifies that all its products that are identified as RoHS-Compliant fulfill the definitions and restrictions defined under Directive 2011/65/EU of The European Parliament and of the Council of June 8, 2011 on the restriction of the use of certain hazardous substances in electrical and electronic equipment (EEE) - recast, unless otherwise specified as non-compliant.**

**Please note that some Vishay documentation may still make reference to RoHS Directive 2002/95/EC. We confirm that all the products identified as being compliant to Directive 2002/95/EC conform to Directive 2011/65/EU.**

**Vishay Intertechnology, Inc. hereby certifies that all its products that are identified as Halogen-Free follow Halogen-Free requirements as per JEDEC JS709A standards. Please note that some Vishay documentation may still make reference to the IEC 61249-2-21 definition. We confirm that all the products identified as being compliant to IEC 61249-2-21 conform to JEDEC JS709A standards.**