



FEATURES

- Optimised bipolar output voltages for IGBT/ Mosfet gate drives
- Basic/supplementary insulation to UL 60950 pending²
- UL60601 (3rd Ed) recognition pending²
- Power density 0.81W/cm³
- 5.2kVDC isolation test voltage
- Ultra low coupling capacitance
- Footprint 1.96cm²
- SIP package style
- 5V, 12V, 15V & 24V inputs
- +15V/-5V, +15V/-8.7V & +20V/-5V outputs
- Operation to 100 °C
- Characterised dv/dt immunity
- Characterised partial discharge performance

PRODUCT OVERVIEW

The MGJ2 series of DC-DC converters is ideal for powering 'high side' and 'low side' gate drive circuits for IGBTs and Mosfets in bridge circuits. A choice of asymmetric output voltages allows optimum drive levels for best system efficiency and EMI. The MGJ2 series is characterised for high isolation and dv/dt requirements commonly seen in bridge circuits used in motor drives and inverters, while the MGJ2 industrial grade temperature rating and construction gives long service life and reliability.

SELECTION GUIDE

Order Code	Nominal Input Voltage	Output Voltage 1	Output Voltage 2	Output Current 1	Output Current 2	Input Current at Rated Load	Load Regulation (Typ)	Load Regulation (Max)	Ripple & Noise (Typ) ³	Ripple & Noise (Max) ³	Efficiency (Min)	Efficiency (Typ)	Isolation Capacitance	MTTF ²
	V	V	V	mA			%		mVp-p		%		pF	kHrs
MGJ2D051505SC	5	15	-5	80	40	360	5.7	7	30	50	71	76	2.8	2095
MGJ2D051509SC	5	15	-8.7	80	40	390	6	7	30	50	73	77.5	3.3	1902
MGJ2D052005SC	5	20	-5	80	40	440	6.2	8	30	50	74	78.5	3.3	1655
MGJ2D121505SC	12	15	-5	80	40	150	4.7	6	30	50	76	80	2.9	2339
MGJ2D121509SC	12	15	-8.7	80	40	155	5.3	7.5	30	50	76	80	3.5	2296
MGJ2D122005SC	12	20	-5	80	40	195	5.5	8	30	45	78	82	3.3	1799
MGJ2D151505SC	15	15	-5	80	40	120	5	7	30	50	75	80	2.9	2374
MGJ2D151509SC	15	15	-8.7	80	40	130	5	7	30	50	76	80	4	2736
MGJ2D152005SC	15	20	-5	80	40	145	6	8	30	50	78	81	3.4	1864
MGJ2D241505SC	24	15	-5	80	40	75	4.6	7	30	50	75	80.5	2.7	2194
MGJ2D241509SC	24	15	-8.7	80	40	80	4.8	7	30	50	77	82	3.5	2275
MGJ2D242005SC	24	20	-5	80	40	90	6	8	30	50	78	82	3.5	1725

INPUT CHARACTERISTICS

Parameter	Conditions	Min.	Typ.	Max.	Units
Voltage range	Continuous operation, 5V input types	4.5	5	5.5	V
	Continuous operation, 12V input types	10.8	12	13.2	
	Continuous operation, 15V input types	13.5	15	16.5	
	Continuous operation, 24V input types	21.6	24	26.4	
Input reflected ripple	5V input types		40		mA
	12V & 15V input types		20		
	24V input types		15		

OUTPUT CHARACTERISTICS

Parameter	Conditions	Min.	Typ.	Max.	Units
Rated Power	T _A = -40°C to 105°C			2	W
Voltage Set Point Accuracy	See tolerance envelopes				
Line regulation	High V _{IN} to low V _{IN}		1.0	1.1	%/%

ABSOLUTE MAXIMUM RATINGS

Short-circuit protection	Continuous
Lead temperature 1mm from case for 10 seconds	260°C
Input voltage V _{IN} , MGJ2D05xxxxSC	5.5V
Input voltage V _{IN} , MGJ2D12xxxxSC	13.2V
Input voltage V _{IN} , MGJ2D15xxxxSC	16.5V
Input voltage V _{IN} , MGJ2D24xxxxSC	26.4V

ISOLATION CHARACTERISTICS

Parameter	Conditions	Min.	Typ.	Max.	Units
Isolation test voltage	Flash tested for 1 second	5200			VDC
Resistance	Viso= 500VDC		1		GΩ

1. Calculated using MIL-HDBK-217 FN2 calculation model with nominal input voltage at full load.
2. See safety approvals section for limitations of use.
3. See ripple & noise test method.

All specifications typical at T_A=25°C, nominal input voltage and rated output current unless otherwise specified.



GENERAL CHARACTERISTICS

Parameter	Conditions	Min.	Typ.	Max.	Units
Switching frequency	All types		45		kHz

TEMPERATURE CHARACTERISTICS

Parameter	Conditions	Min.	Typ.	Max.	Units
Specification	All output types (see safety approval section for limitations)	-40		100	°C
Storage		-55		125	
Case Temperature above ambient	5V input types		24		
	All other input types		20		
Cooling	Free air convection				

TEMPERATURE DERATING GRAPHS

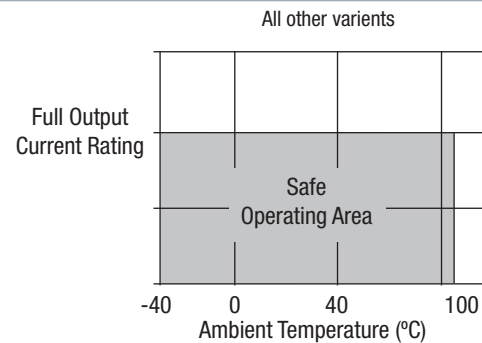
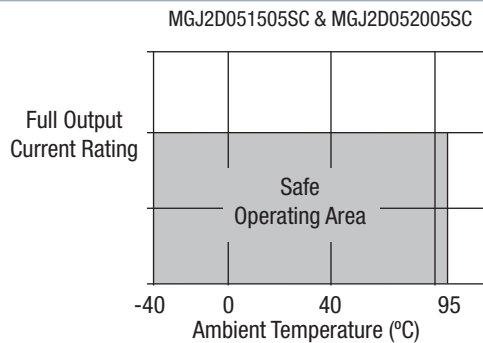

POSITIVE OUTPUT VOLTAGE TOLERANCE ENVELOPES

The voltage tolerance envelopes show typical load regulation characteristics for this product series. The tolerance envelope is the maximum output voltage variation due to changes in output loading and set point accuracy.

MGJ2D051505SC, MGJ2D051509SC, MGJ2D151505SC & MGJ2D151509SC

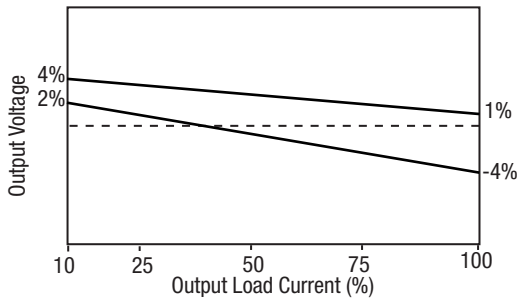

MGJ2D122005SC, MGJ2D152005SC & MGJ2D242005SC

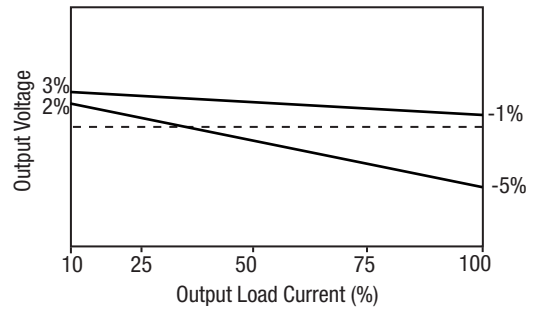

MGJ2D121509SC, MGJ2D241509SC & MGJ2D052005SC

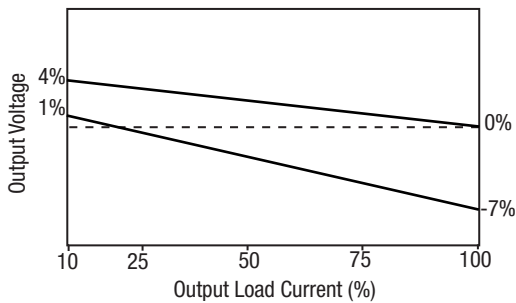

MGJ2D121505SC & MGJ2D241505SC

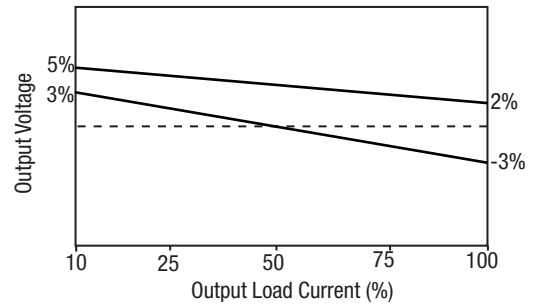

NEGATIVE OUTPUT VOLTAGE TOLERANCE ENVELOPES

MGJ2D051509SC, MGJ2D052005SC & MGJ2D121505SC

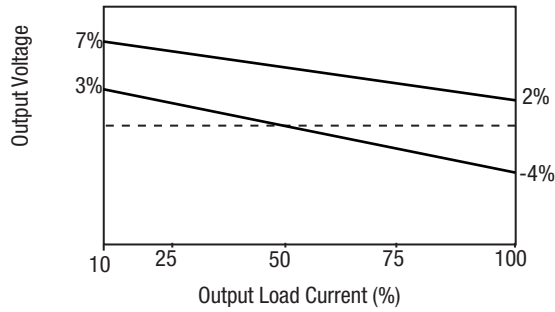

MGJ2D151505SC

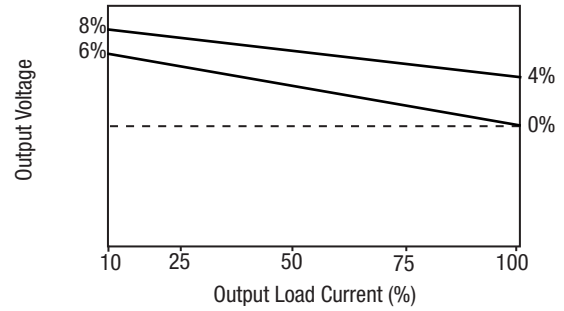

MGJ2D121509SC & MGJ2D241509SC

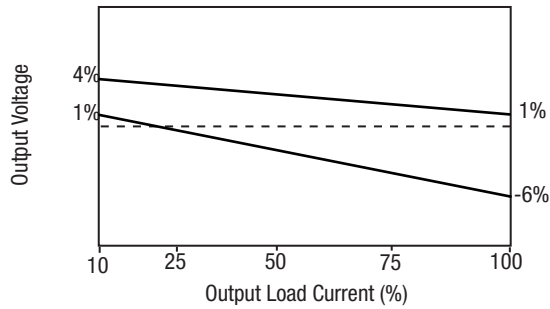

MGJ2D051505SC, MGJ2D122005SC, MGJ2D152005SC & MGJ2D242005SC

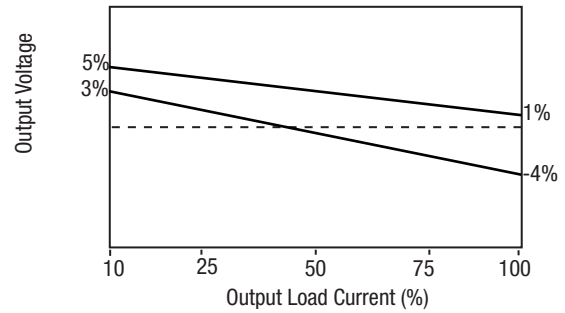

MGJ2D151509SC & MGJ2D241505SC

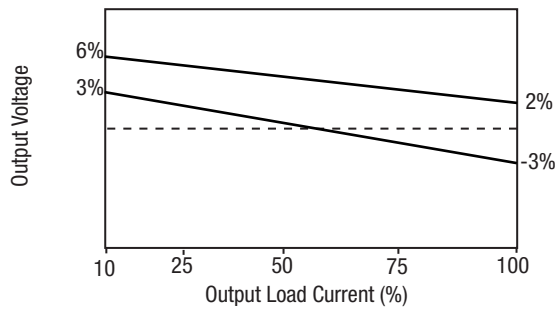

TECHNICAL NOTES

ISOLATION VOLTAGE

'Hi Pot Test', 'Flash Tested', 'Withstand Voltage', 'Proof Voltage', 'Dielectric Withstand Voltage' & 'Isolation Test Voltage' are all terms that relate to the same thing, a test voltage, applied for a specified time, across a component designed to provide electrical isolation, to verify the integrity of that isolation.

Murata Power Solutions MGJ2 series of DC/DC converters are all 100% production tested at their stated isolation voltage. This is 5.2kVDC for 1 second.

A question commonly asked is, "What is the continuous voltage that can be applied across the part in normal operation?"

The MGJ2 series is pending recognition by Underwriters Laboratory for various voltages, please see safety approval section below.

REPEATED HIGH-VOLTAGE ISOLATION TESTING

It is well known that repeated high-voltage isolation testing of a barrier component can actually degrade isolation capability, to a lesser or greater degree depending on materials, construction and environment. We therefore strongly advise against repeated high voltage isolation testing, but if it is absolutely required, that the voltage be reduced by 20% from specified test voltage.

SAFETY APPROVAL

UL 60950

The MGJ2 series is pending recognition by Underwriters Laboratory (UL) to UL 60950 for basic/supplementary insulation to a working voltage of 200Vrms in a maximum ambient temperature of 85°C and/or case temperature limit of 130°C (case temperature measured on the face opposite the pins).

RoHS COMPLIANCE INFORMATION



This series is compatible with RoHS soldering systems with a peak wave solder temperature of 260°C for 10 seconds. The pin termination finish on this product series is Tin Plate, Hot Dipped over Matte Tin with Nickel Preplate. The series is backward compatible with Sn/Pb soldering systems. For further information, please visit www.murata-ps.com/rohs

APPLICATION NOTES

Minimum load

The minimum load to meet datasheet specification is 10% of the full rated load across the specified input voltage range. Lower than 10% minimum loading will result in an increase in output voltage, which may rise to typically double the specified output voltage if the output load falls to less than 5%.

Capacitive loading and start up

Typical start up times for this series, with a typical input voltage rise time of 2.2µs and output capacitance of 10µF, are shown in the table below. The product series will start into a capacitance of 47µF with an increased start time, however, the maximum recommended output capacitance is 10µF.

	Start-up time	
	ms	
MGJ2D051505SC	3.3	
MGJ2D051509SC	4.5	
MGJ2D052005SC	5.4	
MGJ2D121505SC	3.2	
MGJ2D121509SC	4	
MGJ2D122005SC	5.5	
MGJ2D151505SC	2.5	
MGJ2D151509SC	3	
MGJ2D152005SC	4.5	
MGJ2D241505SC	2.7	
MGJ2D241509SC	3	
MGJ2D242005SC	4.2	

Typical Start-Up Wave Form

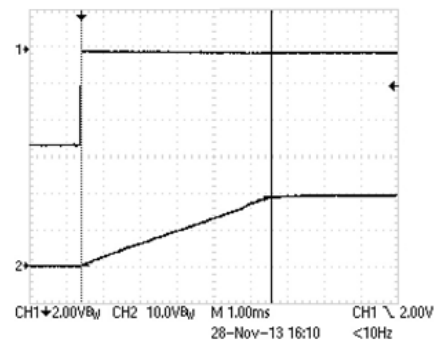

Ripple & Noise Characterisation Method

Ripple and noise measurements are performed with the following test configuration.

C1	1µF X7R multilayer ceramic capacitor, voltage rating to be a minimum of 3 times the output voltage of the DC/DC converter
C2	10µF tantalum capacitor, voltage rating to be a minimum of 1.5 times the output voltage of the DC/DC converter with an ESR of less than 100mΩ at 100 kHz
C3	100nF multilayer ceramic capacitor, general purpose
R1	450Ω resistor, carbon film, ±1% tolerance
R2	50Ω BNC termination
T1	3T of the coax cable through a ferrite toroid
RLOAD	Resistive load to the maximum power rating of the DC/DC converter. Connections should be made via twisted wires

Measured values are multiplied by 10 to obtain the specified values.

Differential Mode Noise Test Schematic

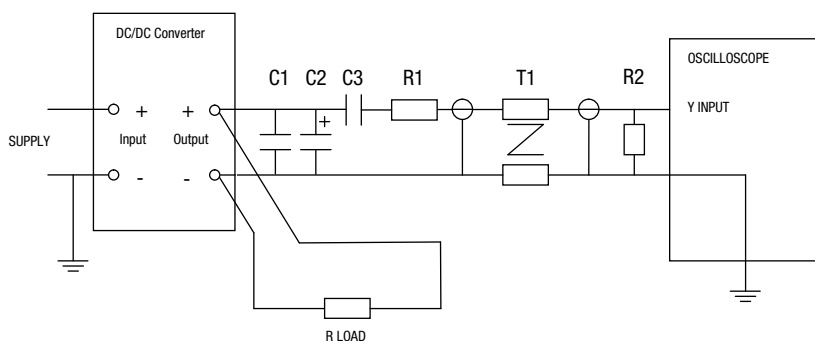

EFFICIENCY VS LOAD

5V INPUT

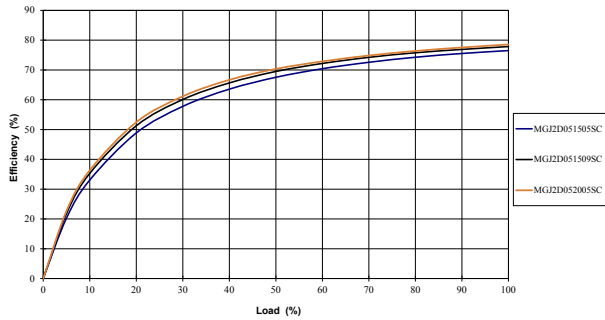

12V INPUT

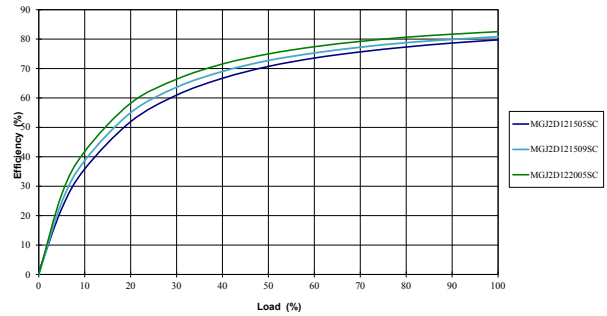

15V INPUT

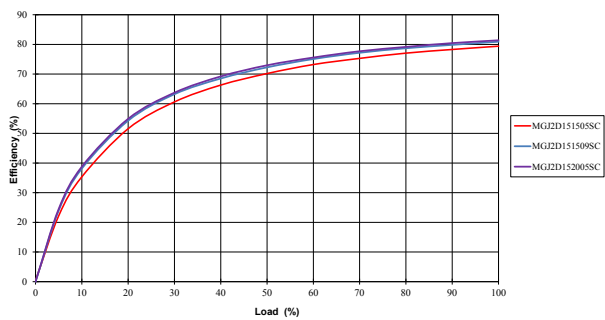

24V INPUT

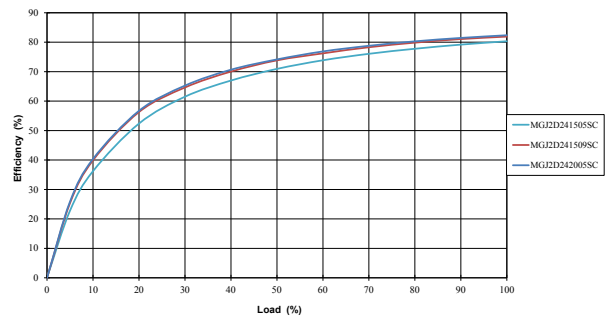

PACKAGE SPECIFICATIONS

MECHANICAL DIMENSIONS

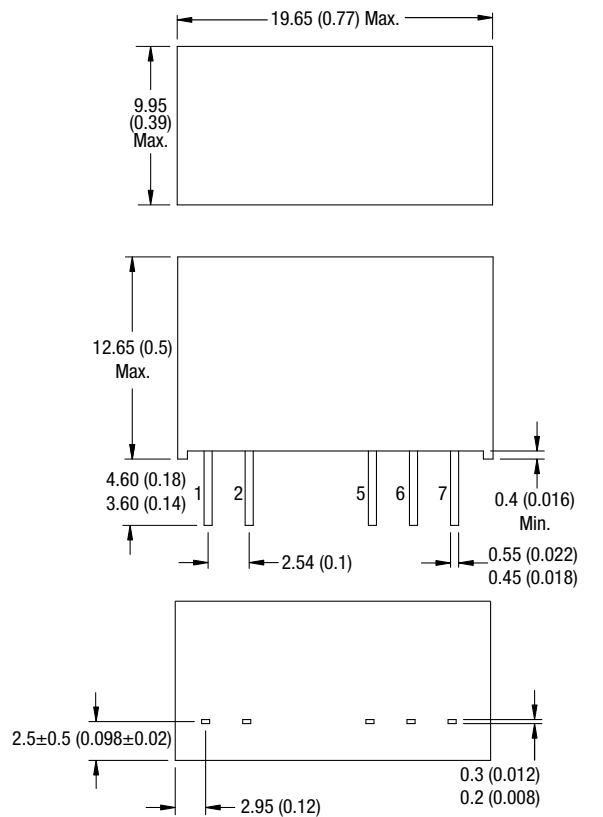

Weight: 4.2g

All dimensions in mm ±0.25mm (inches ±0.01). All pins on a 2.54 (0.1) pitch and within ±0.25 (0.01) of true position.

PIN CONNECTIONS

Pin	Function
1	+VIN
2	-VIN
5	-VOUT
6	OV
7	+VOUT

RECOMMENDED FOOTPRINT DETAILS

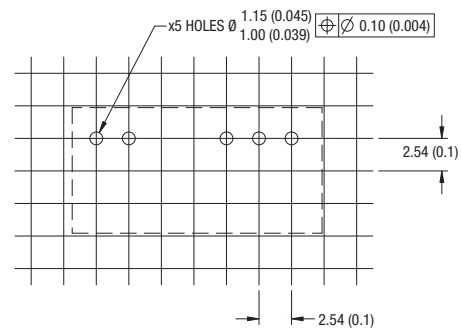

All dimensions in inches ±0.01 (mm ±0.25mm).

TUBE OUTLINE DIMENSIONS

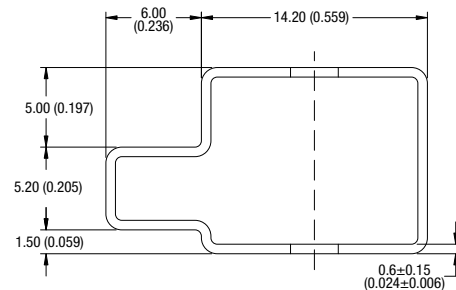

Unless otherwise stated all dimensions in inches ±0.02 (mm ±0.5mm).
Tube length : 20.669±0.079 (525mm±2mm).

Tube Quantity : 25

Murata Power Solutions, Inc.
11 Cabot Boulevard, Mansfield, MA 02048-1151 U.S.A.
ISO 9001 and 14001 REGISTERED



This product is subject to the following **operating requirements** and the **Life and Safety Critical Application Sales Policy**:
Refer to: <http://www.murata-ps.com/requirements/>

Murata Power Solutions, Inc. makes no representation that the use of its products in the circuits described herein, or the use of other technical information contained herein, will not infringe upon existing or future patent rights. The descriptions contained herein do not imply the granting of licenses to make, use, or sell equipment constructed in accordance therewith. Specifications are subject to change without notice. © 2014 Murata Power Solutions, Inc.