

# General Specifications

## Electrical Capacity (Resistive Load)

**Logic Level:** 0.4VA maximum @ 28V AC/DC maximum  
(Applicable Range 0.1mA ~ 0.1A @ 20mV ~ 28V)  
Note: Find additional explanation of operating range in Supplement section.

## Other Ratings

**Contact Resistance:** 50 milliohms maximum  
**Insulation Resistance:** 500 megohms minimum @ 500V DC  
**Dielectric Strength:** 500V AC minimum for 1 minute minimum  
**Mechanical Life:** 100,000 operations minimum  
**Electrical Life:** 50,000 operations minimum  
**Nominal Operating Force:** 1.18N  
**Contact Timing:** Nonshorting (break-before-make)  
**Angle of Throw:** 26°

## Materials & Finishes

**Actuator:** Polyamide  
**Bushing Housing:** Polyamide  
**Case Housing:** Glass fiber reinforced polyamide  
**Support Bracket:** Phosphor bronze with tin plating  
**Movable Contact:** Phosphor bronze with gold plating  
**Stationary Contacts:** Brass with tin plating  
**Terminals:** Brass with gold plating

## Environmental Data

**Operating Temperature Range:** -25°C through +55°C (-13°F through +131°F)  
**Humidity:** 90 ~ 95% humidity for 240 hours @ 40°C (104°F)  
**Vibration:** 10 ~ 55Hz with peak-to-peak amplitude of 1.5mm traversing the frequency range & returning in 5 minutes; 3 right angled directions for 2 hours  
**Shock:** 50G (490m/s<sup>2</sup>) acceleration (tested in 3 right angled directions, with 5 shocks in each direction)

## PCB Processing

**Soldering:** Wave Soldering recommended. See Profile A in Supplement section.  
Manual Soldering: See Profile A in Supplement section.  
**Cleaning:** Automated alcohol based cleaning recommended, 5 minutes maximum. Do not use high-purity alcohol (50% alcohol or more) or organic solvent. High alcohol solution can damage clear plastic. See Cleaning specifications in Supplement section.

## Standards & Certifications

The B Series illuminated toggles have not been tested for UL recognition or CSA certification. These switches are designed for use in a low-voltage, low-current, logic-level circuit. When used as intended in a logic-level circuit, the results do not produce hazardous energy.

# Distinctive Characteristics

LED provides maximum illumination to bushing and actuator, indicating actuator status in highly visible green, red, or amber for single color or red/green for bicolor. (Patent pending.)

Totally sealed body construction prevents contact contamination and allows time- and money-saving automated soldering and cleaning. Molded-in, epoxy sealed terminals lock out flux and other contaminants.

Award-winning STC contact mechanism with benefits unavailable in conventional mechanisms: smoother, positive detent actuation, increased contact stability, and unparalleled logic-level reliability. (Additional STC details in Terms & Acronyms; see Supplement section.)

.100" x .100" (2.54mm x 2.54mm) terminal spacing conforms to standard PC board grid spacing.

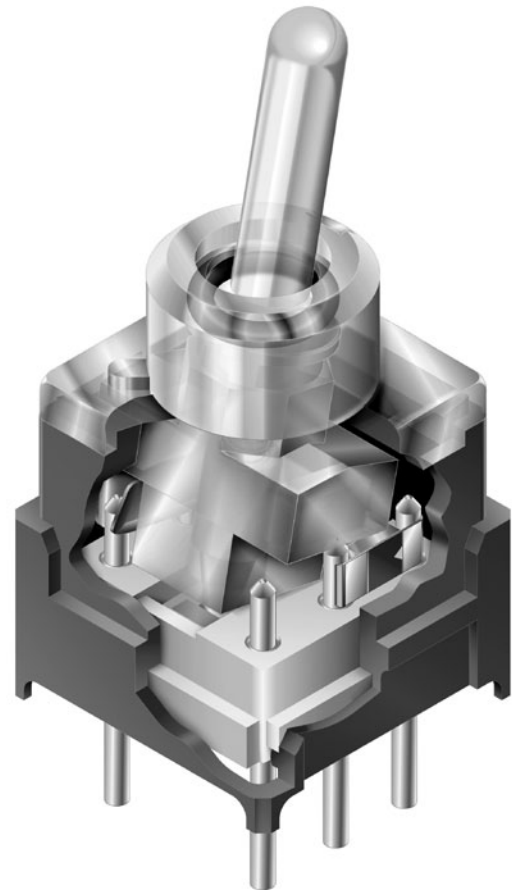

Actual Size

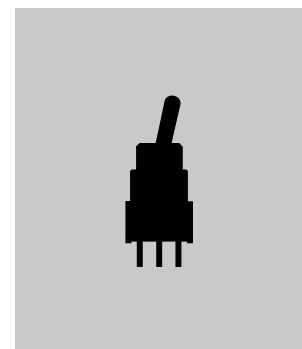

- A Toggles
- Rockers
- Pushbuttons
- Illuminated PB
- Programmable
- Keylocks
- Rotaries
- Slides
- Tactiles
- Tilt
- Touch
- Indicators
- Accessories
- Supplement

Toggles  
A

## TYPICAL SWITCH ORDERING EXAMPLE

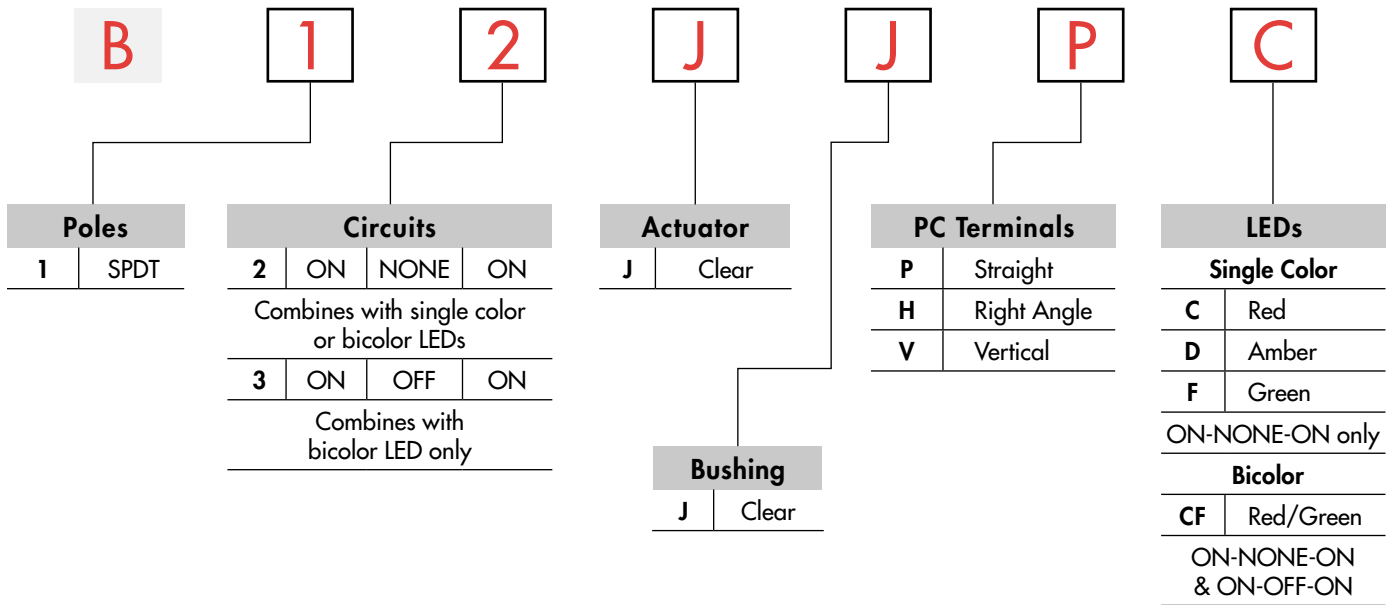

### DESCRIPTION FOR TYPICAL ORDERING EXAMPLE

**B12JJPC**

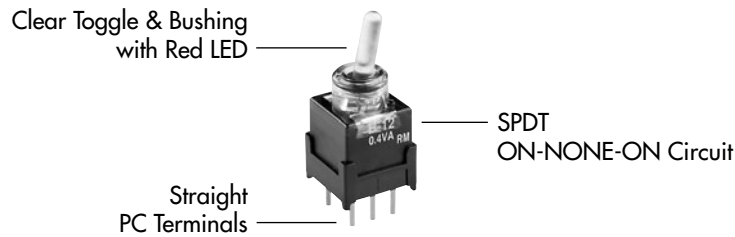

## POLE & CIRCUITS

Pole Throw	Model	Toggle Position			Connected Terminals			Throw & Schematics
		Up	Center	Down	Up	Center	Down	
SPDT	<b>B12</b> <b>B13</b>	ON	NONE	ON	2-3	NONE	2-1	<p>Note: Terminal numbers are not actually on the switch. LED circuit is isolated and requires an external power source.</p> <p>Single Color</p> <p>Bicolor</p>
		ON	OFF	ON	2-3	OPEN	2-1	

## ACTUATOR & BUSHING

**J** Clear Toggle

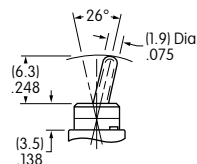

**J** Clear Bushing

Rockers

Pushbuttons

Illuminated PB

Programmable

Keylocks

Rotaries

Slides

Tactiles

Tilt

Touch

Indicators

Accessories

Supplement

## LED COLORS & SPECIFICATIONS

LEDs are an integral part of the switch and not available separately. The electrical specifications shown are determined at a basic temperature of 25°C. If the source voltage exceeds the rated voltage, a ballast resistor is required. The resistor value can be calculated by using the formula in the Supplement section.

	Colors	Single Color			Bicolor
		<b>C</b> Red	<b>D</b> Amber	<b>F</b> Green	<b>CF</b> Red/Green
Forward Peak Current	$I_{FM}$	30mA	30mA	20mA	30mA/20mA
Typical Forward Current	$I_F$	20mA	20mA	10mA	20mA/10mA
Forward Voltage	$V_F$	1.9V	1.9V	3.4V	1.9V/3.4V
Reverse Peak Voltage	$V_{RM}$	5V	5V	5V	5V/5V
Current Reduction Rate Above 25°C	$\Delta I_F$	0.43mA/°C		0.28mA/°C	0.43mA/°C/0.28mA/°C
Ambient Temperature Range		-25°C ~ +55°C			

## PC TERMINALS

**P** Straight

**H** Right Angle with Bracket

**V** Vertical with Bracket

## TYPICAL SWITCH DIMENSIONS

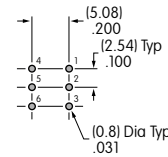
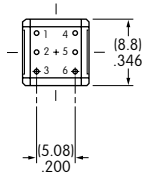
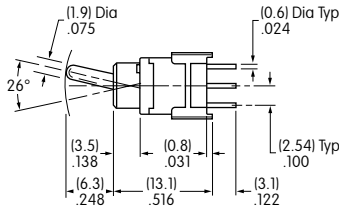
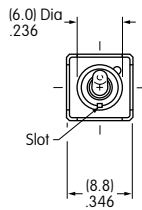

**Straight PC**



**B12JPC**

Terminal 4 is a support pin on single color models.

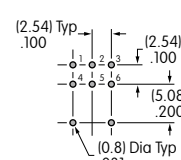
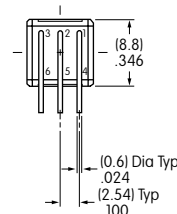
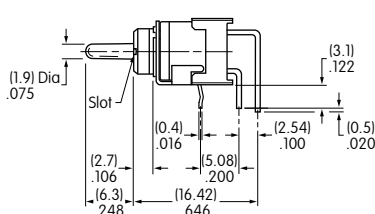
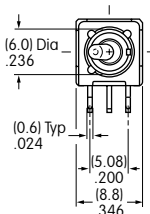
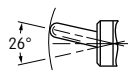

**Right Angle PC**



**B13JJHPC**

Terminal 4 is a support pin on single color models.

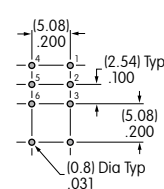
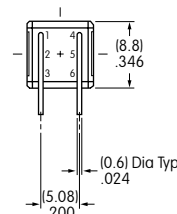
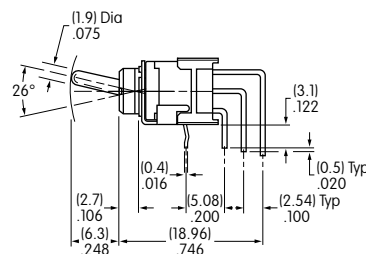
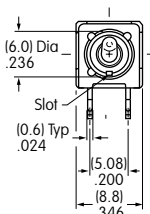

**Vertical PC**



**B13JJVPC**

Terminal 4 is a support pin on single color models.