

High Voltage with Flexible Termination System (HV FT-CAP), C0G Dielectric, 500VDC – 3000VDC (Commercial & Automotive Grade)

Overview

KEMET's High Voltage with Flexible Termination (HV FT-CAP) surface mount MLCCs in C0G dielectric address the primary failure mode of MLCCs—flex cracks, which are typically the result of excessive tensile and shear stresses produced during board flexure and thermal cycling. Featuring several of the highest CV (capacitance/voltage) values available in the industry, these devices utilize a pliable and conductive silver epoxy between the base metal and nickel barrier layers of the termination system. The addition of this epoxy layer inhibits the transfer of board stress to the rigid ceramic body, therefore mitigating flex cracks which can result in low IR or short circuit failures. Although flexible termination technology does not eliminate the potential for mechanical damage that may propagate during extreme environmental and handling conditions, it does provide superior flex performance over standard termination systems.

KEMET's high voltage surface mount MLCCs in C0G dielectric feature a 125°C maximum operating temperature and offers the most stable voltage and temperature performance of all ceramic dielectric materials. C0G (NP0) dielectric capacitors exhibit no change in capacitance with respect to time and voltage and boasts a negligible change in capacitance with reference to ambient temperature. Capacitance change is limited to ± 30 ppm/°C from -55°C to +125°C.

These devices exhibit low ESR at high frequencies and find conventional use as snubbers or filters in applications such as switching power supplies and lighting ballasts. Their exceptional performance at high frequencies has made high voltage MLCC's the preferred dielectric choice of design engineers worldwide. In addition to their use in power supplies, these capacitors are widely used in industries related to automotive(hybrid), telecommunications, medical, military, aerospace, semiconductors and test/diagnostic equipment.

Automotive Grade is available for applications requiring proven, reliable performance in harsh environments. Whether under-the-hood or in-cabin, these capacitors are designed for mission and safety critical automotive circuits. Stricter testing protocol and inspection criteria have been established for automotive grade products in recognition of potentially harsh environmental conditions. KEMET automotive grade series capacitors meet the demanding Automotive Electronics Council's AEC-Q200 qualification requirements.

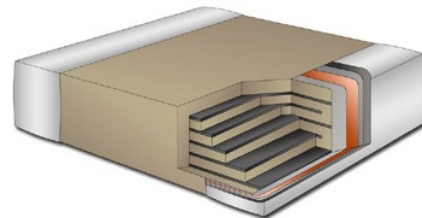

Ordering Information

C	2225	X	393	J	C	G	A	C	TU
Ceramic	Case Size (L" x W")	Specification/ Series	Capacitance Code (pF)	Capacitance Tolerance ¹	Rated Voltage (VDC)	Dielectric	Failure Rate/ Design	Termination Finish ²	Packaging/Grade (C-Spec) ³
	0805 1206 1210 1808 1812 1825 2220 2225	X= Flexible Termination	2 significant digits + number of zeros.	B = ± 0.10 pF C = ± 0.25 pF D = ± 0.5 pF F = $\pm 1\%$ G = $\pm 2\%$ J = $\pm 5\%$ K = $\pm 10\%$ M = $\pm 20\%$	C = 500 V B = 630 V D = 1000 V F = 1500 V G = 2000 V Z = 2500 V H = 3000 V	G = C0G	A = N/A	C = 100% Matte Sn L = SnPb (5% minimum)	Blank = Bulk TU = 7" Reel - Unmarked AUTO = Automotive Grade 7" Reel - Unmarked

¹ Additional capacitance tolerance offerings may be available. Contact KEMET for details.

² Additional termination finish options may be available. Contact KEMET for details.

^{2,3} SnPb termination finish option is not available on automotive grade product.

³ Additional reeling or packaging options may be available. Contact KEMET for details.

Dimensions – Millimeters (Inches)

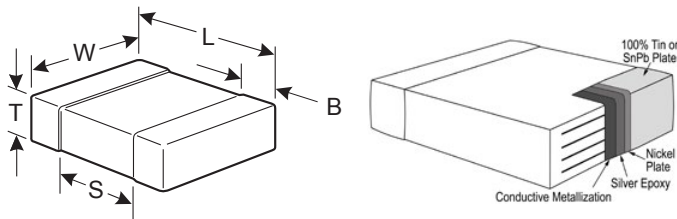

EIA Size Code	Metric Size Code	L Length	W Width	T Thickness	B Bandwidth	S Separation Minimum	Mounting Technique
0805	2012	2.00 (.079) ± 0.20 (.008)	1.25 (.049) ± 0.20 (.008)	See Table 2 for Thickness	0.50 (0.02) ± 0.25 (.010)	0.75 (.030)	Solder Wave or Solder Reflow
1206	3216	3.30 (.130) ± 0.40 (.016)	1.60 (.063) ± 0.20 (.008)		0.60 (.024) ± 0.25 (.010)	N/A	
1210	3225	3.30 (.130) ± 0.40 (.016)	2.50 (.098) ± 0.20 (.008)		0.60 (.024) ± 0.25 (.010)		Solder Reflow Only
1808	4520	4.70 (.185) ± 0.50 (.020)	2.00 (.079) ± 0.20 (.008)		0.70 (.028) ± 0.35 (.014)		
1812	4532	4.50 (.178) ± 0.40 (.016)	3.20 (.126) ± 0.30 (.012)		0.70 (.028) ± 0.35 (.014)		
1825	4564	4.60 (.181) ± 0.40 (.016)	6.40 (.252) ± 0.40 (.016)		0.70 (.028) ± 0.35 (.014)		
2220	5650	5.90 (.232) ± 0.75 (.030)	5.00 (.197) ± 0.40 (.016)		0.70 (.028) ± 0.35 (.014)		
2225	5664	5.90 (.232) ± 0.75 (.030)	6.40 (.248) ± 0.40 (.016)		0.70 (.028) ± 0.35 (.014)		

Benefits

- -55°C to +125°C operating temperature range
- Superior flex performance (up to 5mm)
- Lead (Pb)-Free, RoHS, and REACH compliant
- EIA 0805, 1206, 1210, 1808, 1812, 1825, 2220 and 2225 case sizes
- DC voltage ratings of 500 V, 630 V, 1 KV, 1.5 KV, 2 KV, 2.5 KV and 3 KV
- Capacitance offerings ranging from 1 pF to 0.039 µF
- Available capacitance tolerances of ±0.10 pF, ±0.25 pF, ±0.5 pF, ±1%, ±2%, ±5%, ±10% and ±20%
- No piezoelectric noise
- Extremely low ESR & ESL
- High thermal stability
- High ripple current capability
- Preferred capacitance solution at line frequencies & into the MHz range
- No capacitance change with respect to applied rated DC voltage
- Negligible capacitance change with respect to temperature from -55°C to +125°C
- No capacitance decay with time
- Non-polar device, minimizing installation concerns
- Commercial & Automotive (AEC-Q200) grades available
- 100% pure matte tin-plated termination finish allowing for excellent solderability
- SnPb plated termination finish option available upon request (5% min)

Applications

Typical applications include switch mode power supplies (input filters, resonators, tank circuits, snubbed circuits, output filters), high voltage coupling and DC blocking, lighting ballasts, voltage multiplier circuits, DC/DC converters and coupling capacitors in Ćuk converters. Markets include power supply, LCD fluorescent backlight ballasts, HID lighting, telecom equipment, industrial and medical equipment/control, LAN/WAN interface, analog and digital modems, and automotive.

Qualification/Certification

Commercial Grade products are subject to internal qualification. Details regarding test methods and conditions are referenced in Table 4, Performance and Reliability.

Automotive Grade products meet or exceed the requirements outlined by the Automotive Electronics Council. Details regarding test methods and conditions are referenced in document AEC-Q200, Stress Test Qualification for Passive Components. For additional information regarding the Automotive Electronics Council and AEC-Q200, please visit their website at www.aecouncil.com.

Environmental Compliance

Lead (Pb)-Free, RoHS, and REACH compliant without exemptions (excluding SnPb termination finish option).



RoHS Compliant

Electrical Parameters/Characteristics

Item	Parameters/Characteristics
Operating Temperature Range	-55°C to +125°C
Capacitance Change with Reference to +25°C and 0 VDC Applied (TCC)	±30 ppm/°C
Aging Rate (Maximum % Capacitance Loss/Decade Hour)	0%
Dielectric Withstanding Voltage (DWV)	150% of rated voltage for voltage rating of < 1000 V 120% of rated voltage for voltage rating of ≥ 1000 V (5 ±1 seconds and charge/discharge not exceeding 50 mA)
Dissipation Factor (DF) Maximum Limit @ 25°C	0.1%
Insulation Resistance (IR) Limit @ 25°C	1000 megohm microfarads or 100 GΩ (500 VDC applied for 120 ±5 secs @ 25°C)

To obtain IR limit, divide MΩ-μF value by the capacitance and compare to GΩ limit. Select the lower of the two limits.

Capacitance and Dissipation Factor (DF) measured under the following conditions:

1 MHz ±100 kHz and 1.0 Vrms ±0.2 V if capacitance ≤ 1,000 pF

1 kHz ± 50 Hz and 1.0 Vrms ±0.2 V if capacitance > 1,000 pF

Note: When measuring capacitance it is important to ensure the set voltage level is held constant. The HP4284 and Agilent E4980 have a feature known as Automatic Level Control (ALC). The ALC feature should be switched to "ON."

Post Environmental Limits

High Temperature Life, Biased Humidity, Moisture Resistance					
Dielectric	Rated DC Voltage	Capacitance Value	Dissipation Factor (Maximum %)	Capacitance Shift	Insulation Resistance
COG	All	All	0.5	0.3% or ±0.25 pF	10% of Initial Limit

Table 1A – Capacitance Range/Selection Waterfall (0805 – 1808 Case Sizes)

Capacitance	Cap Code	Case Size / Series					C0805X			C1206X					C1210X					C1808X									
		Voltage Code					C	B	D	C	B	D	F	G	C	B	D	F	G	C	B	D	F	G	Z	H			
		Rated Voltage (VDC)					500	630	1000	500	630	1000	1500	2000	500	630	1000	1500	2000	500	630	1000	1500	2000	2500	3000			
		Capacitance Tolerance					Product Availability and Chip Thickness Codes See Table 2 for Chip Thickness Dimensions																						
1.0 - 9.1 pF*	109 - 169*	B	C	D	F	G	J	K	M	DG	DG	DG	EG	EG	EG	EG	EG	FM	FM	FM	FM	FM	LB	LB	LB	LB	LB	LB	LB
10 pF	100				F	G	J	K	M	DG	DG	DG	EG	EG	EG	EG	EG	FM	FM	FM	FM	FM	LB	LB	LB	LB	LB	LB	LB
11 pF	110				F	G	J	K	M	DG	DG	DG	EG	EG	EG	EG	EG	FM	FM	FM	FM	FM	LB	LB	LB	LB	LB	LB	LB
12 pF	120				F	G	J	K	M	DG	DG	DG	EG	EG	EG	EG	EG	FM	FM	FM	FM	FM	LB	LB	LB	LB	LB	LB	LB
13 pF	130				F	G	J	K	M	DG	DG	DG	EG	EG	EG	EG	EG	FM	FM	FM	FM	FM	LB	LB	LB	LB	LB	LB	LB
15 pF	150				F	G	J	K	M	DG	DG	DG	EG	EG	EG	EG	EG	FM	FM	FM	FM	FM	LB	LB	LB	LB	LB	LB	LB
16 pF	160				F	G	J	K	M	DG	DG	DG	EG	EG	EG	EG	EG	FM	FM	FM	FM	FM	LB	LB	LB	LB	LB	LB	LB
18 pF	180				F	G	J	K	M	DG	DG	DG	EG	EG	EG	EG	EG	FM	FM	FM	FM	FM	LB	LB	LB	LB	LB	LB	LB
20 pF	200				F	G	J	K	M	DG	DG	DG	EG	EG	EG	EG	EG	FM	FM	FM	FM	FM	LB	LB	LB	LB	LB	LB	LB
22 pF	220				F	G	J	K	M	DG	DG	DG	EG	EG	EG	EG	EG	FM	FM	FM	FM	FM	LB	LB	LB	LB	LB	LB	LB
24 pF	240				F	G	J	K	M	DG	DG	DG	EG	EG	EG	EG	EG	FM	FM	FM	FM	FM	LB	LB	LB	LB	LB	LB	LB
27 pF	270				F	G	J	K	M	DG	DG	DG	EG	EG	EG	EG	EG	FM	FM	FM	FM	FM	LB	LB	LB	LB	LB	LB	LB
30 pF	300				F	G	J	K	M	DG	DG	DG	EG	EG	EG	EG	EG	FM	FM	FM	FM	FM	LB	LB	LB	LB	LB	LB	LB
33 pF	330				F	G	J	K	M	DG	DG	DG	EG	EG	EG	EG	EG	FM	FM	FM	FM	FM	LB	LB	LB	LB	LB	LB	LB
36 pF	360				F	G	J	K	M	DG	DG	DG	EG	EG	EG	EG	EG	FM	FM	FM	FM	FM	LB	LB	LB	LB	LB	LB	LB
39 pF	390				F	G	J	K	M	DG	DG	DG	EG	EG	EG	EG	EG	FM	FM	FM	FM	FM	LB	LB	LB	LB	LB	LB	LB
43 pF	430				F	G	J	K	M	DG	DG	DG	EG	EG	EG	EG	EG	FM	FM	FM	FM	FM	LB	LB	LB	LB	LB	LB	LB
47 pF	470				F	G	J	K	M	DG	DG	DG	EG	EG	EG	EG	EG	FM	FM	FM	FM	FM	LB	LB	LB	LB	LB	LB	LB
51 pF	510				F	G	J	K	M	DG	DG	DG	EF	EF	EF	EG	EG	FM	FM	FM	FM	FM	LB	LB	LB	LB	LB	LB	LB
56 pF	560				F	G	J	K	M	DG	DG	DG	EF	EF	EF	EG	EG	FM	FM	FM	FM	FM	LB	LB	LB	LB	LB	LB	LB
62 pF	620				F	G	J	K	M	DG	DG	DG	EF	EF	EF	EG	EG	FM	FM	FM	FM	FM	LB	LB	LB	LB	LB	LB	LB
68 pF	680				F	G	J	K	M	DG	DG	DG	EF	EF	EF	EG	EG	FM	FM	FM	FM	FM	LB	LB	LB	LB	LB	LB	LB
75 pF	750				F	G	J	K	M	DG	DG	DG	EF	EF	EF	EG	EG	FM	FM	FM	FM	FM	LB	LB	LB	LB	LB	LB	LB
82 pF	820				F	G	J	K	M	DG	DG	DG	EF	EF	EF	EG	EG	FM	FM	FM	FM	FM	LB	LB	LB	LB	LB	LB	LB
91 pF	910				F	G	J	K	M	DG	DG	DG	EF	EF	EF	EG	EG	FM	FM	FM	FM	FM	LB	LB	LB	LB	LB	LB	LB
100 pF	101				F	G	J	K	M	DG	DG	DG	EF	EF	EF	EG	EG	FM	FM	FM	FM	FM	LB	LB	LB	LB	LB	LC	LB
110 pF	111				F	G	J	K	M	DG	DG	DG	EF	EF	EF	EG	EG	FM	FM	FM	FM	FM	LB	LB	LB	LB	LB	LC	LB
120 pF	121				F	G	J	K	M	DG	DG	DG	EF	EF	EF	EG	EG	FG	FG	FG	FM	FM	LA	LA	LA	LA	LB	LC	LB
130 pF	131				F	G	J	K	M	DG	DG	DG	EF	EF	EF	EG	EG	FG	FG	FG	FM	FM	LA	LA	LA	LA	LB	LC	LB
150 pF	151				F	G	J	K	M	DG	DG	DG	EF	EF	EF	EG	EG	FG	FG	FG	FM	FM	LA	LA	LA	LA	LB	LC	LB
160 pF	161				F	G	J	K	M	DG	DG	DG	EF	EF	EF	EG	EG	FG	FG	FG	FM	FM	LA	LA	LA	LA	LC	LC	LC
180 pF	181				F	G	J	K	M	DG	DG	DG	EF	EF	EF	EG	EG	FG	FG	FG	FM	FM	LA	LA	LA	LA	LC	LC	LC
200 pF	201				F	G	J	K	M	DG	DG	DG	EF	EG	EG	EG	EG	FG	FG	FG	FM	FM	LA	LA	LA	LA	LC	LC	LC
220 pF	221				F	G	J	K	M	DG	DG	DG	EF	EG	EG	EG	EG	FG	FG	FG	FM	FM	LA	LA	LA	LA	LC	LC	LC
240 pF	241				F	G	J	K	M	DG	DG	DG	EF	EG	EG	EG	EG	FG	FG	FG	FM	FM	LA	LA	LA	LB	LC	LC	
270 pF	271				F	G	J	K	M	DG	DG	DG	EF	EG	EG	EG	EG	FG	FG	FG	FK	FK	LA	LA	LA	LB	LC	LC	
300 pF	301				F	G	J	K	M	DG	DG	DG	EF	EG	EG	EG	EG	FG	FG	FG	FK	FK	LA	LA	LA	LB	LC	LC	
330 pF	331				F	G	J	K	M	DG	DG	DG	EF	EG	EG	EG	EG	FG	FG	FG	FK	FK	LA	LA	LA	LB	LC	LC	
360 pF	361				F	G	J	K	M	DG	DG	DG	EG	EG	EG	EG	EG	FG	FG	FG	FK	FS	LA	LA	LA	LB	LA	LC	
390 pF	391				F	G	J	K	M	DG	DG	DG	EG	EG	EG	EG	EG	FG	FG	FG	FK	FS	LA	LA	LA	LB	LA	LC	
430 pF	431				F	G	J	K	M	DG	DG	DG	EG	EG	EG	EG	EG	FG	FM	FM	FS	FS	LA	LB	LB	LC	LA		
470 pF	471				F	G	J	K	M	DG	DG	DG	EG	EG	EG	EG	EG	FG	FM	FM	FS	FS	LA	LB	LB	LC	LA		
510 pF	511				F	G	J	K	M	DG	DG	DG	EG	EG	EG	EG	EG	FG	FM	FM	FS	FS	LA	LB	LB	LC	LB		
560 pF	561				F	G	J	K	M	DG	DG	DG	EG	EG	EG	EG	EG	FG	FM	FM	FS	FS	LA	LB	LB	LC	LB		
620 pF	621				F	G	J	K	M	DG	DG	DG	EG	EG	EG	EG	EG	FG	FM	FM	FS	FS	LA	LB	LB	LA	LC		
680 pF	681				F	G	J	K	M	DG	DG	DG	EG	EG	EG	EG	EG	FG	FM	FM	FS	FS	LB	LB	LB	LA	LC		
750 pF	751				F	G	J	K	M	DG	DG	DG	EG	EF	EG	EG	EG	FG	FM	FM	FM	FM	LB	LB	LB	LA			
820 pF	821				F	G	J	K	M	DG	DG	DG	EG	EF	EG	EG	EG	FG	FM	FM	FM	FM	LB	LB	LB	LA			
910 pF	911				F	G	J	K	M	DG	DG	DG	EG	EF	EG	EG	EG	FM	FM	FM	FY	FY	LB	LB	LB	LA			
1,000 pF	102				F	G	J	K	M	DG	DG	DG	EG	EF	EG	EG	EG	FM	FM	FM	FY	FY	LB	LB	LB	LB			
1,100 pF	112				F	G	J	K	M	DG	DG	DG	EF	EG	EG	EG	EG	FM	FK	FK	FS	FS	LC	LC	LC	LB			

*Capacitance range Includes E24 decade values only. (i.e., 10, 11, 12, 13, 15, 16, 18, 20, 22, 24, 27, 30, 33, 36, 39, 43, 47, 51, 56, 62, 68, 75, 82 and 91)

KEMET reserves the right to substitute product with an improved temperature characteristic, tighter capacitance tolerance and/or higher voltage capability within the same form factor (configuration and dimensions).

These products are protected under US Patents 7,172,985 and 7,670,981, other patents pending, and any foreign counterparts.

Table 1A – Capacitance Range/Selection Waterfall (0805 – 1808 Case Sizes) cont'd

Capacitance	Cap Code	Case Size / Series						C0805X					C1206X					C1210X					C1808X												
		Voltage Code						C	B	D	C	B	D	F	G	C	B	D	F	G	C	B	D	F	G	Z	H								
		Rated Voltage (VDC)						500	630	1000	500	630	1000	1500	2000	500	630	1000	1500	2000	500	630	1000	1500	2000	2500	3000								
		Capacitance Tolerance						Product Availability and Chip Thickness Codes See Table 2 for Chip Thickness Dimensions																											
1,200 pF	122					F	G	J	K	M						EF	EG							FM	FK	FK	FS	LC	LC	LC	LC				
1,300 pF	132					F	G	J	K	M						EF	EG							FM	FS	FS	LC	LC	LC	LC					
1,500 pF	152					F	G	J	K	M						EF	EG							FK	FS	FS	LC	LC	LC	LC					
1,600 pF	162					F	G	J	K	M						EF	EG							FK	FS	FS	LC	LC	LC						
1,800 pF	182					F	G	J	K	M						EF	EG							FK	FS	FS	LC	LC	LC						
2,000 pF	202					F	G	J	K	M						EG								FK	FL	FS	LC	LA	LB						
2,200 pF	222					F	G	J	K	M						EG								FK	FL	FS	LC	LA	LB						
2,400 pF	242					F	G	J	K	M						EG								FS	FL	FS	LC	LA	LB						
2,700 pF	272					F	G	J	K	M						EG								FS	FL	FS	LC	LA	LC						
3,000 pF	302					F	G	J	K	M														FS	FL										
3,300 pF	332					F	G	J	K	M														FS	FM										
3,600 pF	362					F	G	J	K	M														FL	FM										
3,900 pF	392					F	G	J	K	M														FL	FY										
4,300 pF	432					F	G	J	K	M														FM	FY										
4,700 pF	472					F	G	J	K	M														FM	FY					LA	LC				
5,100 pF	512					F	G	J	K	M														FY	FS					LA					
5,200 pF	562					F	G	J	K	M														FY	FS					LB					
6,200pF	622					F	G	J	K	M														FY						LC					
6,800pF	682					F	G	J	K	M														FY						LC					
7,500pF	752					F	G	J	K	M														FS											
8,200pF	822					F	G	J	K	M														FS											
Capacitance	Cap Code	Rated Voltage (VDC)						500	630	1000	500	630	1000	1500	2000	500	630	1000	1500	2000	500	630	1000	1500	2000	2500	3000								
		Voltage Code						C	B	D	C	B	D	F	G	C	B	D	F	G	C	B	D	F	G	Z	H								
		Case Size / Series						C0805X					C1206X					C1210X					C1808X												

KEMET reserves the right to substitute product with an improved temperature characteristic, tighter capacitance tolerance and/or higher voltage capability within the same form factor (configuration and dimensions).

These products are protected under US Patents 7,172,985 and 7,670,981, other patents pending, and any foreign counterparts..

Table 1B – Capacitance Range/Selection Waterfall (1812 – 2225 Case Sizes) cont'd

Cap	Cap Code	Case Size / Series				C1812X				C1825X				C2220X				C2225X															
		Voltage Code				C	B	D	F	G	Z	H	C	B	D	F	G	Z	H	C	B	D	F	G	Z	H	C	B	D	F	G	Z	H
		Rated Voltage (VDC)				500	630	1000	1500	2000	2500	3000	500	630	1000	1500	2000	2500	3000	500	630	1000	1500	2000	2500	3000	500	630	1000	1500	2000	2500	3000
		Capacitance Tolerance				Product Availability and Chip Thickness Codes See Table 2 for Chip Thickness Dimensions																											
1,100 pF	112	F	G	J	K	M	GH	GK	GK	GH	GO					HJ		JE	JK	JK	JK	JK	JK		KE	KE	KE	KF	KF	KF			
1,200 pF	122	F	G	J	K	M	GH	GK	GK	GH	GO					HJ		JE	JK	JK	JK	JK	JL		KE	KE	KE	KF	KF	KF			
1,300 pF	132	F	G	J	K	M	GH	GK	GK	GH	GO					HE	HJ	JE	JK	JK	JK	JE	JL		KE	KE	KE	KF	KF	KH			
1,500 pF	152	F	G	J	K	M	GK	GK	GK	GK	GO					HE	HK	JE	JK	JK	JK	JE	JL		KE	KE	KE	KF	KF	KH			
1,600 pF	162	F	G	J	K	M	GK	GK	GK	GK						HG	HK	JE	JK	JK	JK	JE	JL		KE	KE	KE	KF	KE	KH			
1,800 pF	182	F	G	J	K	M	GK	GK	GK	GM						HG		JE	JK	JK	JK	JE	JN		KE	KE	KE	KF	KE	KH			
2,000 pF	202	F	G	J	K	M	GK	GK	GK	GM					HE	HJ	JE	JK	JK	JE	JK				KE	KE	KE	KF	KE	KJ			
2,200 pF	222	F	G	J	K	M	GK	GK	GK	GO					HE	HJ	JE	JK	JK	JE	JK				KE	KE	KE	KF	KF	KJ			
2,400 pF	242	F	G	J	K	M	GK	GH	GK	GO					HE	HJ	JK	JK	JK	JE	JL				KE	KE	KE	KE	KH				
2,700 pF	272	F	G	J	K	M	GK	GH	GK	GO					HE	HK	JK	JK	JK	JE	JL				KE	KE	KE	KE	KH				
3,000 pF	302	F	G	J	K	M	GK	GH	GK						HE	HK	JK	JK	JK	JE	JL				KE	KE	KE	KE	KH				
3,300 pF	332	F	G	J	K	M	GK	GH	GK						HG		JK	JK	JK	JK	JN				KE	KE	KE	KE	KJ				
3,600 pF	362	F	G	J	K	M	GK	GH	GM						HG		JK	JK	JK	JK	JN				KE	KF	KF	KF	KJ				
3,900 pF	392	F	G	J	K	M	GK	GH	GM						HJ		JK	JK	JK	JK	JN				KE	KF	KF	KF	KJ				
4,300 pF	432	F	G	J	K	M	GH	GH	GO						HJ		JK	JK	JK	JK					KE	KF	KF	KF					
4,700 pF	472	F	G	J	K	M	GH	GH	GO						HJ		JK	JK	JK	JL					KE	KF	KF	KH					
5,100 pF	512	F	G	J	K	M	GH	GK	GO						HE	HG	HK		JK	JK	JK	JL			KE	KF	KF	KH					
5,600 pF	562	F	G	J	K	M	GH	GK	GO						HE	HG	HK		JK	JK	JK	JN			KE	KF	KF	KH					
6,200 pF	622	F	G	J	K	M	GH	GK							HE	HG		JK	JE	JE	JN				KE	KF	KF	KJ					
6,800 pF	682	F	G	J	K	M	GH	GM							HE	HJ		JK	JE	JK	JN				KE	KF	KF	KJ					
7,500 pF	752	F	G	J	K	M	GH	GM							HE	HJ		JK	JE	JK					KF	KE	KF						
8,200 pF	822	F	G	J	K	M	GK	GO							HE	HJ		JK	JE	JL					KF	KE	KF						
9,100 pF	912	F	G	J	K	M	GM	GO							HE	HG	HK		JE	JE	JL				KF	KE	KH						
10,000 pF	103	F	G	J	K	M	GM	GO							HE	HG	HK		JE	JE	JL				KF	KE	KH						
12,000 pF	123	F	G	J	K	M	GO								HE	HG		JE	JK	JN					KE	KE	KH						
15,000 pF	153	F	G	J	K	M	GO								HE	HJ		JE	JL						KE	KF	KJ						
18,000 pF	183	F	G	J	K	M									HG	HK		JE	JL						KE	KH							
22,000 pF	223	F	G	J	K	M									HJ			JK	JN						KF	KJ							
27,000 pF	273	F	G	J	K	M									HJ			JL	JN						KF	KJ							
33,000 pF	333	F	G	J	K	M									HK			JN							KH								
39,000 pF	393	F	G	J	K	M																			KJ								
Cap	Cap Code	Rated Voltage (VDC)				500	630	1000	1500	2000	2500	3000	500	630	1000	1500	2000	2500	3000	500	630	1000	1500	2000	2500	3000	500	630	1000	1500	2000	2500	3000
		Voltage Code				C	B	D	F	G	Z	H	C	B	D	F	G	Z	H	C	B	D	F	G	Z	H	C	B	D	F	G	Z	H
		Case Size / Series				C1812X				C1825X				C2220X				C2225X															

KEMET reserves the right to substitute product with an improved temperature characteristic, tighter capacitance tolerance and/or higher voltage capability within the same form factor (configuration and dimensions).

These products are protected under US Patents 7,172,985 and 7,670,981, other patents pending, and any foreign counterparts..

Table 2 – Chip Thickness/Packaging Quantities

Thickness Code	Case Size	Thickness ± Range (mm)	Paper Quantity		Plastic Quantity	
			7" Reel	13" Reel	7" Reel	13" Reel
DG	0805	1.25 ± 0.15	0	0	2,500	10,000
EF	1206	1.20 ± 0.15	0	0	2,500	10,000
EG	1206	1.60 ± 0.15	0	0	2,000	8,000
FG	1210	1.25 ± 0.15	0	0	2,500	10,000
FL	1210	1.40 ± 0.15	0	0	2,000	8,000
FM	1210	1.70 ± 0.20	0	0	2,000	8,000
FY	1210	2.00 ± 0.20	0	0	2,000	8,000
FK	1210	2.10 ± 0.20	0	0	2,000	8,000
FS	1210	2.50 ± 0.30	0	0	1,000	4,000
LA	1808	1.40 ± 0.15	0	0	1,000	4,000
LB	1808	1.60 ± 0.15	0	0	1,000	4,000
LC	1808	2.00 ± 0.15	0	0	1,000	4,000
GH	1812	1.40 ± 0.15	0	0	1,000	4,000
GK	1812	1.60 ± 0.20	0	0	1,000	4,000
GM	1812	2.00 ± 0.20	0	0	500	2,000
GO	1812	2.50 ± 0.20	0	0	500	2,000
HE	1825	1.40 ± 0.15	0	0	1,000	4,000
HG	1825	1.60 ± 0.20	0	0	1,000	4,000
HJ	1825	2.00 ± 0.20	0	0	500	2,000
HK	1825	2.50 ± 0.20	0	0	500	2,000
JE	2220	1.40 ± 0.15	0	0	1,000	4,000
JK	2220	1.60 ± 0.20	0	0	1,000	4,000
JL	2220	2.00 ± 0.20	0	0	500	2,000
JN	2220	2.50 ± 0.20	0	0	500	2,000
KE	2225	1.40 ± 0.15	0	0	1,000	4,000
KF	2225	1.60 ± 0.20	0	0	1,000	4,000
KH	2225	2.00 ± 0.20	0	0	500	2,000
KJ	2225	2.50 ± 0.20	0	0	500	2,000
Thickness Code	Case Size	Thickness ± Range (mm)	7" Reel	13" Reel	7" Reel	13" Reel
			Paper Quantity		Plastic Quantity	

Package quantity based on finished chip thickness specifications.

Table 3 – Chip Capacitor Land Pattern Design Recommendations per IPC–7351

EIA Size Code	Metric Size Code	Density Level A: Maximum (Most) Land Protrusion (mm)					Density Level B: Median (Nominal) Land Protrusion (mm)					Density Level C: Minimum (Least) Land Protrusion (mm)				
		C	Y	X	V1	V2	C	Y	X	V1	V2	C	Y	X	V1	V2
0805	2012	1.00	1.35	1.55	4.40	2.60	0.90	1.15	1.45	3.50	2.00	0.80	0.95	1.35	2.80	1.70
1206	3216	1.60	1.65	1.90	5.90	2.90	1.50	1.45	1.80	5.00	2.30	1.40	1.25	1.70	4.30	2.00
1210	3225	1.60	1.65	2.80	5.90	3.80	1.50	1.45	2.70	5.00	3.20	1.40	1.25	2.60	4.30	2.90
1808	4520	2.25	1.85	2.30	7.40	3.30	2.15	1.65	2.20	6.50	2.70	2.05	1.45	2.10	5.80	2.40
1812	4532	2.10	1.80	3.60	7.00	4.60	2.00	1.60	3.50	6.10	4.00	1.90	1.40	3.40	5.40	3.70
1825	4564	2.15	1.80	6.90	7.10	7.90	2.05	1.60	6.80	6.20	7.30	1.95	1.40	6.70	5.50	7.00
2220	5650	2.85	2.10	5.50	8.80	6.50	2.75	1.90	5.40	7.90	5.90	2.65	1.70	5.30	7.20	5.60
2225	5664	2.85	2.10	6.90	8.80	7.90	2.75	1.90	6.80	7.90	7.30	2.65	1.70	6.70	7.20	7.00

Density Level A: For low-density product applications. Recommended for wave solder applications and provides a wider process window for reflow solder processes. KEMET only recommends wave soldering of EIA 0603, 0805 and 1206 case sizes.

Density Level B: For products with a moderate level of component density. Provides a robust solder attachment condition for reflow solder processes.

Density Level C: For high component density product applications. Before adapting the minimum land pattern variations the user should perform qualification testing based on the conditions outlined in IPC Standard 7351 (IPC–7351).

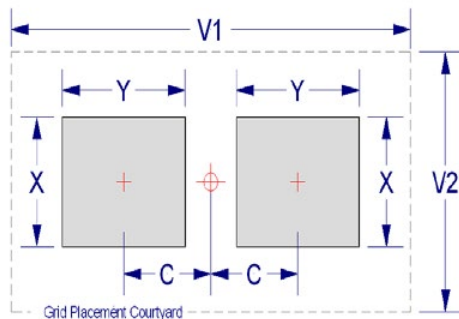

Soldering Process

Recommended Soldering Technique:

- Solder wave or solder reflow for EIA case sizes 0603, 0805 and 1206
- All other EIA case sizes are limited to solder reflow only

Recommended Reflow Soldering Profile:

KEMET's families of surface mount multilayer ceramic capacitors (SMD MLCCs) are compatible with wave (single or dual), convection, IR or vapor phase reflow techniques. Preheating of these components is recommended to avoid extreme thermal stress. KEMET's recommended profile conditions for convection and IR reflow reflect the profile conditions of the IPC/J-STD-020 standard for moisture sensitivity testing. These devices can safely withstand a maximum of three reflow passes at these conditions.

Profile Feature	Termination Finish	
	SnPb	100% Matte Sn
Preheat/Soak		
Temperature Minimum (T_{Smin})	100°C	150°C
Temperature Maximum (T_{Smax})	150°C	200°C
Time (t_s) from T_{Smin} to T_{Smax}	60 – 120 seconds	60 – 120 seconds
Ramp-Up Rate (T_L to T_p)	3°C/second maximum	3°C/second maximum
Liquidous Temperature (T_L)	183°C	217°C
Time Above Liquidous (t_L)	60 – 150 seconds	60 – 150 seconds
Peak Temperature (T_p)	235°C	260°C
Time Within 5°C of Maximum Peak Temperature (t_p)	20 seconds maximum	30 seconds maximum
Ramp-Down Rate (T_p to T_L)	6°C/second maximum	6°C/second maximum
Time 25°C to Peak Temperature	6 minutes maximum	8 minutes maximum

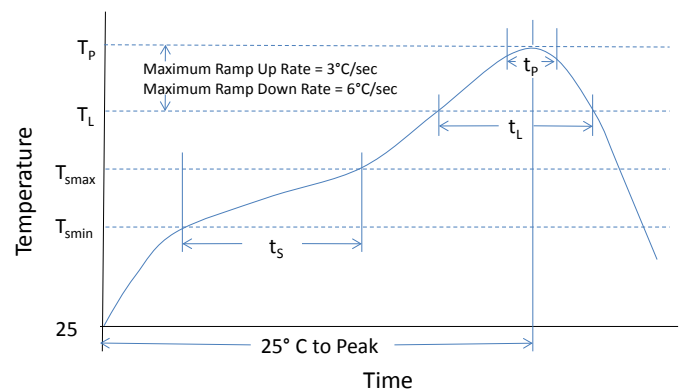

Note 1: All temperatures refer to the center of the package, measured on the capacitor body surface that is facing up during assembly reflow.

Table 4 – Performance & Reliability: Test Methods and Conditions

Stress	Reference	Test or Inspection Method
Terminal Strength	JIS-C-6429	Appendix 1, Note: Force of 1.8 kg for 60 seconds.
Board Flex	JIS-C-6429	Appendix 2, Note: Standard termination system – 2.0 mm (minimum) for all except 3 mm for COG. Flexible termination system – 3.0 mm (minimum).
Solderability	J-STD-002	Magnification 50 X. Conditions:
		a) Method B, 4 hours @ 155°C, dry heat @ 235°C
		b) Method B @ 215°C category 3
		c) Method D, category 3 @ 260°C
Temperature Cycling	JESD22 Method JA-104	1,000 cycles (-55°C to +125°C). Measurement at 24 hours +/- 2 hours after test conclusion.
Biased Humidity	MIL-STD-202 Method 103	Load Humidity: 1,000 hours 85°C/85% RH and 200 VDC maximum. Add 100 K ohm resistor. Measurement at 24 hours +/- 2 hours after test conclusion.
		Low Volt Humidity: 1,000 hours 85°C/85% RH and 1.5 V. Add 100 K ohm resistor. Measurement at 24 hours +/- 2 hours after test conclusion.
Moisture Resistance	MIL-STD-202 Method 106	t = 24 hours/cycle. Steps 7a and 7b not required. Unpowered. Measurement at 24 hours +/- 2 hours after test conclusion.
Thermal Shock	MIL-STD-202 Method 107	-55°C/+125°C. Note: Number of cycles required – 300. Maximum transfer time – 20 seconds. Dwell time – 15 minutes. Air – Air.
High Temperature Life	MIL-STD-202 Method 108	1,000 hours at 125°C (85°C for X5R, Z5U and Y5V) with 1.2 X rated voltage applied.
Storage Life	MIL-STD-202 Method 108	150°C, 0 VDC for 1,000 hours.
Vibration	MIL-STD-202 Method 204	5 g's for 20 min., 12 cycles each of 3 orientations. Note: Use 8" X 5" PCB 0.031" thick 7 secure points on one long side and 2 secure points at corners of opposite sides. Parts mounted within 2" from any secure point. Test from 10 – 2,000 Hz
Mechanical Shock	MIL-STD-202 Method 213	Figure 1 of Method 213, Condition F.
Resistance to Solvents	MIL-STD-202 Method 215	Add aqueous wash chemical, OKEM Clean or equivalent.

Storage and Handling

Ceramic chip capacitors should be stored in normal working environments. While the chips themselves are quite robust in other environments, solderability will be degraded by exposure to high temperatures, high humidity, corrosive atmospheres, and long term storage. In addition, packaging materials will be degraded by high temperature– reels may soften or warp and tape peel force may increase. KEMET recommends that maximum storage temperature not exceed 40°C and maximum storage humidity not exceed 70% relative humidity. Temperature fluctuations should be minimized to avoid condensation on the parts and atmospheres should be free of chlorine and sulfur bearing compounds. For optimized solderability chip stock should be used promptly, preferably within 1.5 years of receipt.

Construction

Reference	Item	Material
A	Termination System	Finish
B		Barrier Layer
C		Epoxy Layer
D		Base Metal
E	Inner Electrode	Ni
F	Dielectric Material	CaZrO ₃

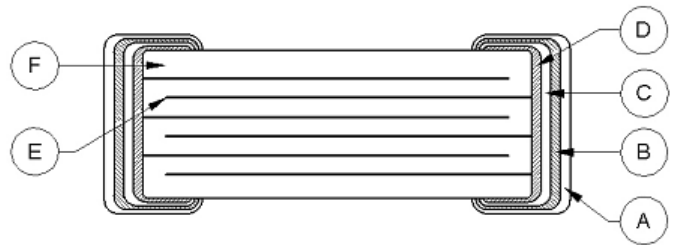

Note: Image is exaggerated in order to clearly identify all components of construction.

Capacitor Marking (Optional):

Laser marking option is not available on:

- COG, Ultra Stable X8R and Y5V dielectric devices
- EIA 0402 case size devices
- EIA 0603 case size devices with Flexible Termination option.
- KPS Commercial and Automotive grade stacked devices.

These capacitors are supplied unmarked only.

Tape & Reel Packaging Information

KEMET offers multilayer ceramic chip capacitors packaged in 8, 12 and 16 mm tape on 7" and 13" reels in accordance with EIA Standard 481. This packaging system is compatible with all tape-fed automatic pick and place systems. See Table 2 for details on reeling quantities for commercial chips.

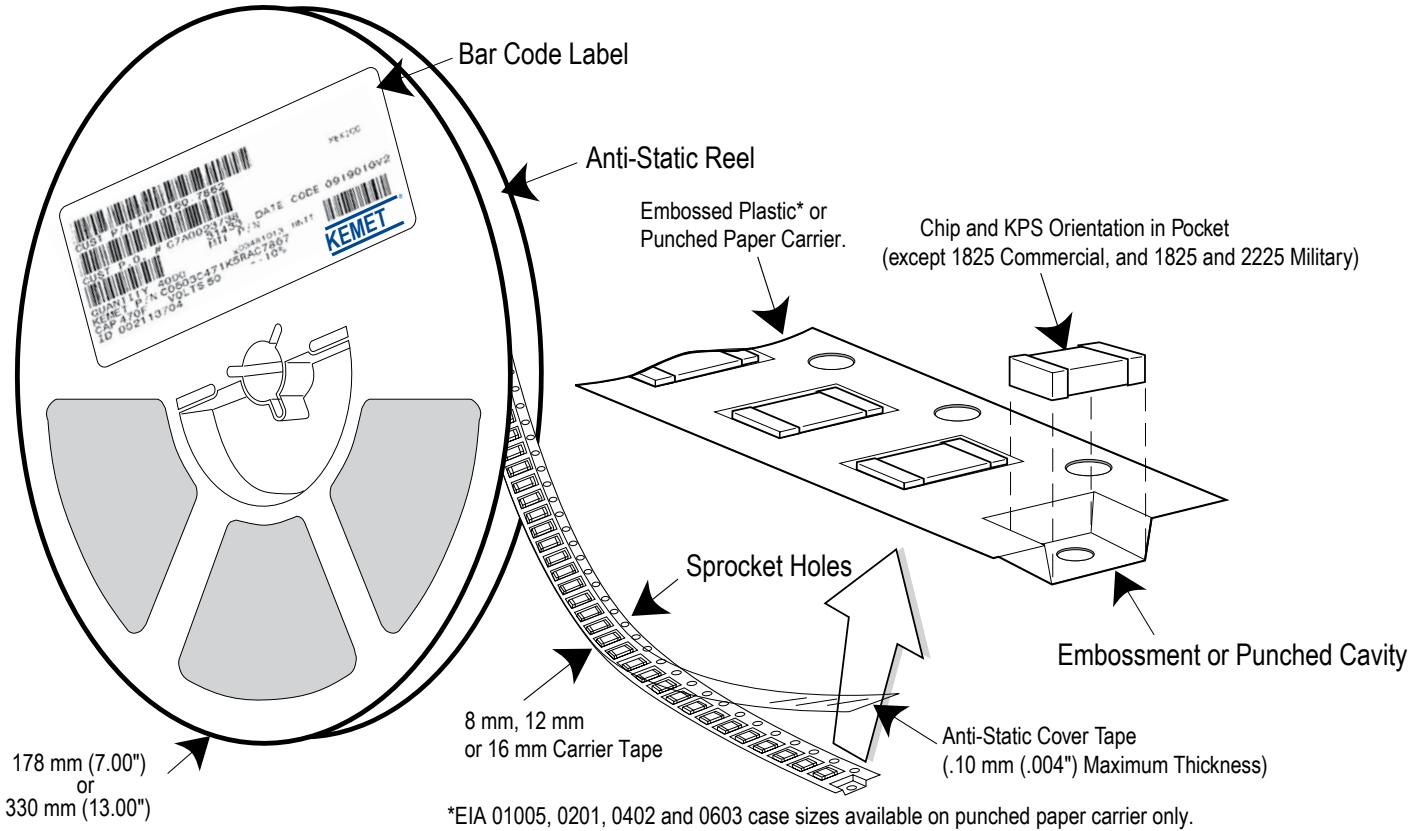

Table 5 – Carrier Tape Configuration – Embossed Plastic & Punched Paper (mm)

EIA Case Size	Tape Size (W)*	Pitch (P ₁)*
01005 – 0402	8	2
0603 – 1210	8	4
1805 – 1808	12	4
≥ 1812	12	8
KPS 1210	12	8
KPS 1812 & 2220	16	12
Array 0508 & 0612	8	4

*Refer to Figures 1 & 2 for W and P₁ carrier tape reference locations.

*Refer to Tables 6 & 7 for tolerance specifications.

Figure 1 – Embossed (Plastic) Carrier Tape Dimensions

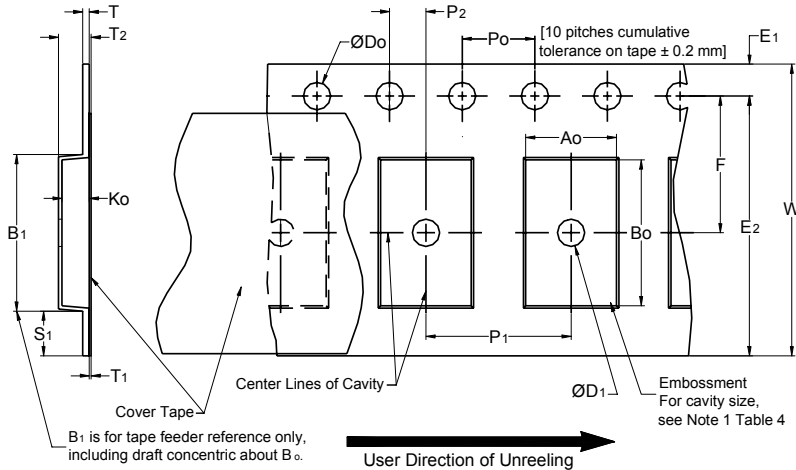

Table 6 – Embossed (Plastic) Carrier Tape Dimensions

Metric will govern

Constant Dimensions — Millimeters (Inches)									
Tape Size	D ₀	D ₁ Minimum Note 1	E ₁	P ₀	P ₂	R Reference Note 2	S ₁ Minimum Note 3	T Maximum	T ₁ Maximum
8 mm	1.5 +0.10/-0.0 (0.059 +0.004/-0.0)	1.0 (0.039)	1.75 ±0.10 (0.069 ±0.004)	4.0 ±0.10 (0.157 ±0.004)	2.0 ±0.05 (0.079 ±0.002)	25.0 (0.984)	0.600 (0.024)	0.600 (0.024)	0.100 (0.004)
12 mm		1.5 (0.059)				30 (1.181)			
16 mm									
Variable Dimensions — Millimeters (Inches)									
Tape Size	Pitch	B ₁ Maximum Note 4	E ₂ Minimum	F	P ₁	T ₂ Maximum	W Maximum	A ₀ , B ₀ & K ₀	
8 mm	Single (4 mm)	4.35 (0.171)	6.25 (0.246)	3.5 ±0.05 (0.138 ±0.002)	4.0 ±0.10 (0.157 ±0.004)	2.5 (0.098)	8.3 (0.327)	Note 5	
12 mm	Single (4 mm) & Double (8 mm)	8.2 (0.323)	10.25 (0.404)	5.5 ±0.05 (0.217 ±0.002)	8.0 ±0.10 (0.315 ±0.004)	4.6 (0.181)	12.3 (0.484)		
16 mm	Triple (12 mm)	12.1 (0.476)	14.25 (0.561)	7.5 ±0.05 (0.138 ±0.002)	12.0 ±0.10 (0.157 ±0.004)	4.6 (0.181)	16.3 (0.642)		

- The embossment hole location shall be measured from the sprocket hole controlling the location of the embossment. Dimensions of embossment location and hole location shall be applied independent of each other.
- The tape with or without components shall pass around R without damage (see Figure 6).
- If S₁ < 1.0 mm, there may not be enough area for cover tape to be properly applied (see EIA Standard 481 paragraph 4.3 section b).
- B₁ dimension is a reference dimension for tape feeder clearance only.
- The cavity defined by A₀, B₀ and K₀ shall surround the component with sufficient clearance that:
 - the component does not protrude above the top surface of the carrier tape.
 - the component can be removed from the cavity in a vertical direction without mechanical restriction, after the top cover tape has been removed.
 - rotation of the component is limited to 20° maximum for 8 and 12 mm tapes and 10° maximum for 16 mm tapes (see Figure 3).
 - lateral movement of the component is restricted to 0.5 mm maximum for 8 and 12 mm wide tape and to 1.0 mm maximum for 16 mm tape (see Figure 4).
 - for KPS Series product, A₀ and B₀ are measured on a plane 0.3 mm above the bottom of the pocket.
 - see Addendum in EIA Standard 481 for standards relating to more precise taping requirements.

Figure 2 – Punched (Paper) Carrier Tape Dimensions

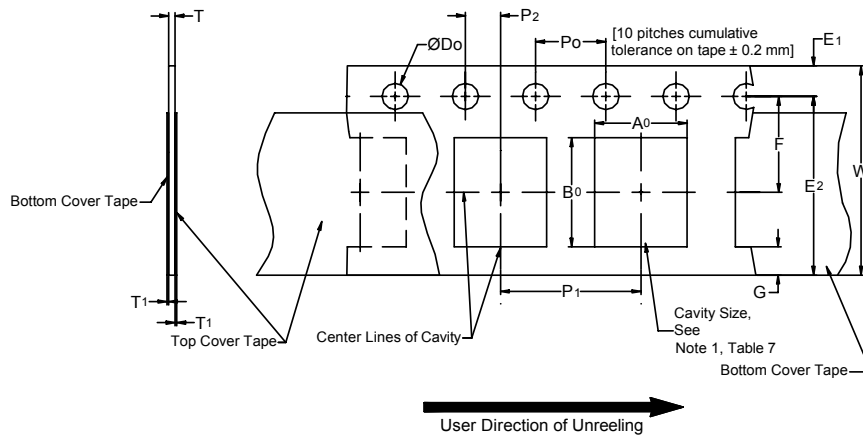

Table 7 – Punched (Paper) Carrier Tape Dimensions

Metric will govern

Constant Dimensions — Millimeters (Inches)							
Tape Size	D_0	E_1	P_0	P_2	T_1 Maximum	G Minimum	R Reference Note 2
8 mm	1.5 +0.10 -0.0 (0.059 +0.004 -0.0)	1.75 ±0.10 (0.069 ±0.004)	4.0 ±0.10 (0.157 ±0.004)	2.0 ±0.05 (0.079 ±0.002)	0.10 (0.004) Maximum	0.75 (0.030)	25 (0.984)
Variable Dimensions — Millimeters (Inches)							
Tape Size	Pitch	E2 Minimum	F	P_1	T Maximum	W Maximum	$A_0 B_0$
8 mm	Half (2 mm)	6.25 (0.246)	3.5 ±0.05 (0.138 ±0.002)	2.0 ±0.05 (0.079 ±0.002)	1.1 (0.098)	8.3 (0.327)	Note 1
8 mm	Single (4 mm)			4.0 ±0.10 (0.157 ±0.004)		8.3 (0.327)	

- The cavity defined by A_0 , B_0 and T shall surround the component with sufficient clearance that:
 - the component does not protrude beyond either surface of the carrier tape.
 - the component can be removed from the cavity in a vertical direction without mechanical restriction, after the top cover tape has been removed.
 - rotation of the component is limited to 20° maximum (see Figure 3).
 - lateral movement of the component is restricted to 0.5 mm maximum (see Figure 4).
 - see Addendum in EIA Standard 481 for standards relating to more precise taping requirements.
- The tape with or without components shall pass around R without damage (see Figure 6).

Packaging Information Performance Notes

- 1. Cover Tape Break Force:** 1.0 Kg minimum.
- 2. Cover Tape Peel Strength:** The total peel strength of the cover tape from the carrier tape shall be:

Tape Width	Peel Strength
8 mm	0.1 to 1.0 Newton (10 to 100 gf)
12 and 16 mm	0.1 to 1.3 Newton (10 to 130 gf)

The direction of the pull shall be opposite the direction of the carrier tape travel. The pull angle of the carrier tape shall be 165° to 180° from the plane of the carrier tape. During peeling, the carrier and/or cover tape shall be pulled at a velocity of 300 ±10 mm/minute.

- 3. Labeling:** Bar code labeling (standard or custom) shall be on the side of the reel opposite the sprocket holes. Refer to EIA Standards 556 and 624.

Figure 3 – Maximum Component Rotation

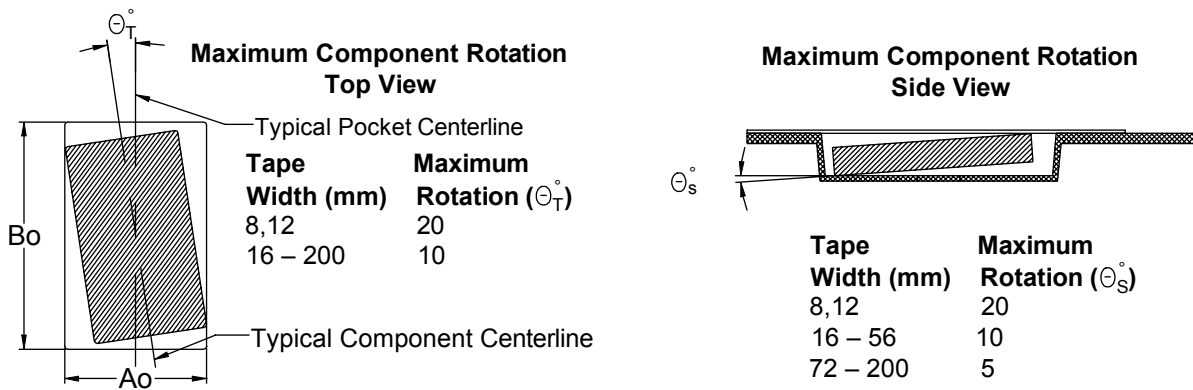

Figure 4 – Maximum Lateral Movement

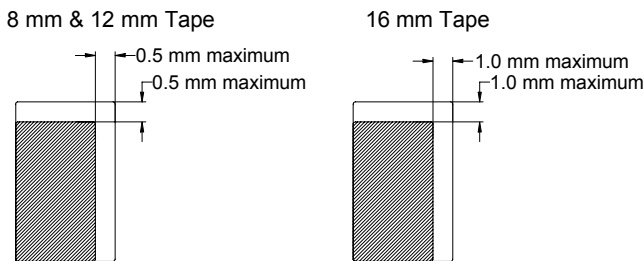

Figure 5 – Bending Radius

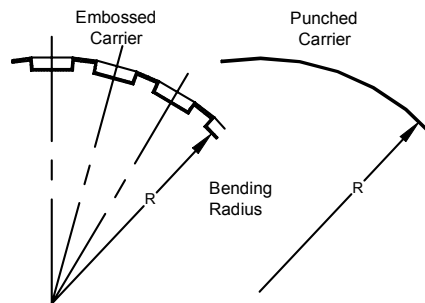

Figure 6 – Reel Dimensions

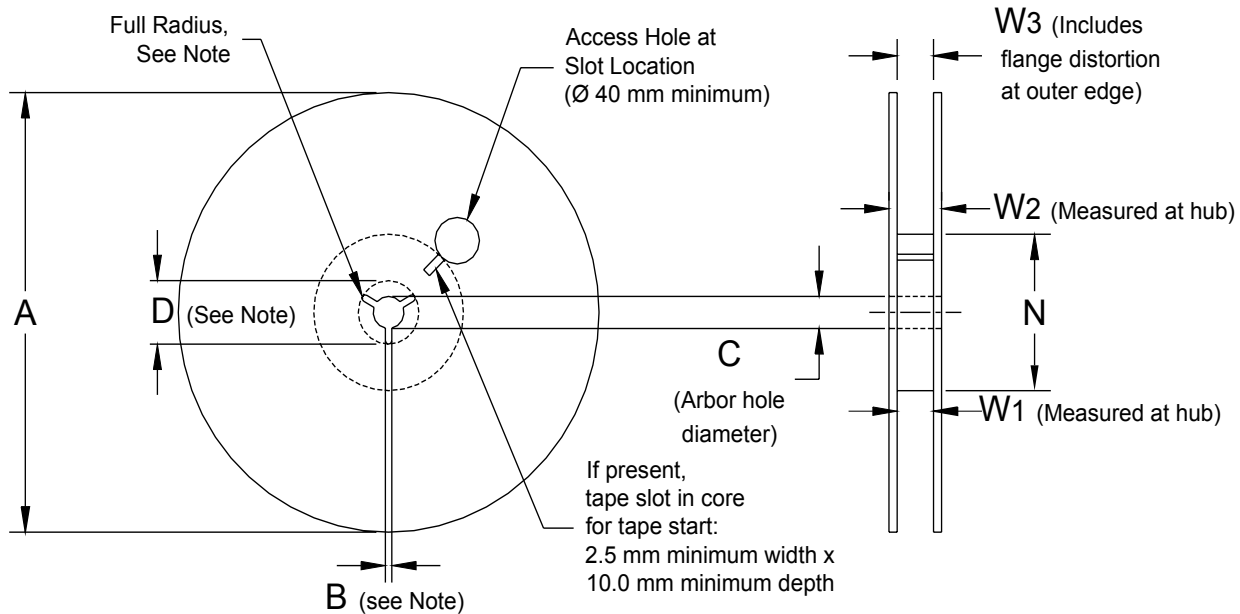

Table 8 – Reel Dimensions

Metric will govern

Constant Dimensions — Millimeters (Inches)				
Tape Size	A	B Minimum	C	D Minimum
8 mm	178 ±0.20 (7.008 ±0.008) or 330 ±0.20 (13.000 ±0.008)	1.5 (0.059)	13.0 +0.5/-0.2 (0.521 +0.02/-0.008)	20.2 (0.795)
12 mm				
16 mm				
Variable Dimensions — Millimeters (Inches)				
Tape Size	N Minimum	W ₁	W ₂ Maximum	W ₃
8 mm	50 (1.969)	8.4 +1.5/-0.0 (0.331 +0.059/-0.0)	14.4 (0.567)	Shall accommodate tape width without interference
12 mm		12.4 +2.0/-0.0 (0.488 +0.078/-0.0)	18.4 (0.724)	
16 mm		16.4 +2.0/-0.0 (0.646 +0.078/-0.0)	22.4 (0.882)	

Figure 7 – Tape Leader & Trailer Dimensions

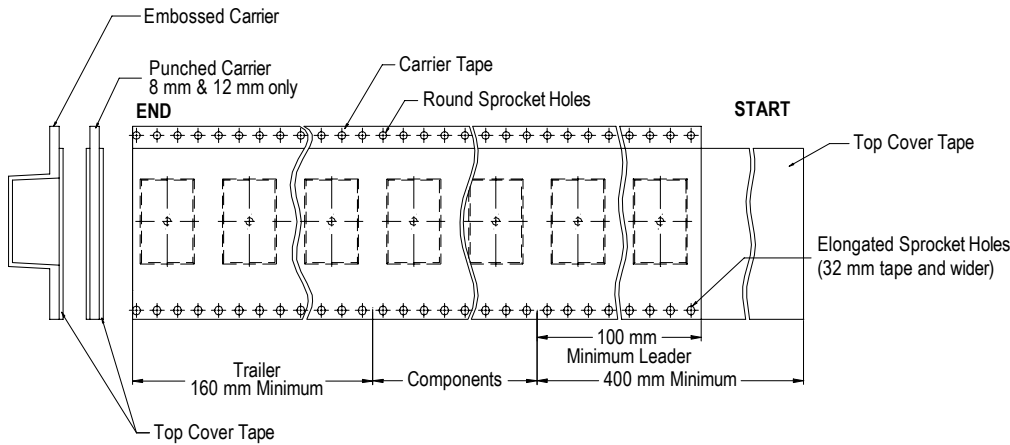
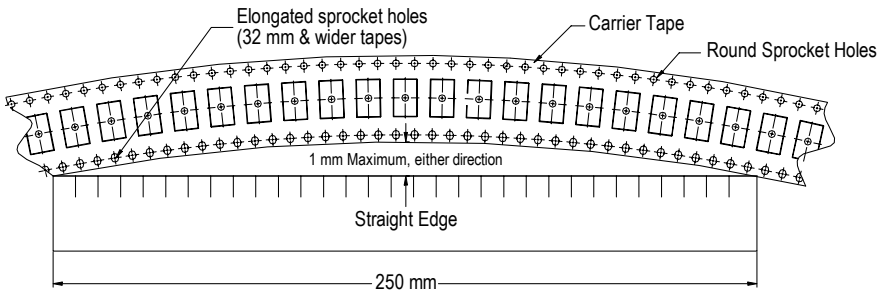

Figure 8 – Maximum Camber



Bulk Cassette Packaging (Ceramic Chips Only)

Meets Dimensional Requirements IEC-286 and EIAJ 7201

Unit mm *Reference

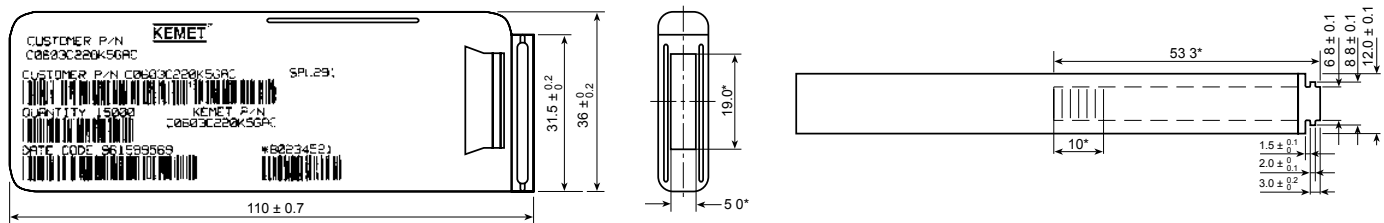

Capacitor Dimensions for Bulk Cassette

Cassette Packaging – Millimeters

EIA Size Code	Metric Size Code	L Length	W Width	B Bandwidth	S Separation Minimum	T Thickness	Number of Pieces/Cassette
0402	1005	1.0 ± 0.05	0.5 ± 0.05	0.2 to 0.4	0.3	0.5 ± 0.05	50,000
0603	1608	1.6 ± 0.07	0.8 ± 0.07	0.2 to 0.5	0.7	0.8 ± 0.07	15,000

KEMET Corporation World Headquarters

2835 KEMET Way
Simpsonville, SC 29681

Mailing Address:
P.O. Box 5928
Greenville, SC 29606

www.kemet.com
Tel: 864-963-6300
Fax: 864-963-6521

Corporate Offices
Fort Lauderdale, FL
Tel: 954-766-2800

North America

Southeast
Lake Mary, FL
Tel: 407-855-8886

Northeast
Wilmington, MA
Tel: 978-658-1663

Central
Novi, MI
Tel: 248-994-1030

West
Milpitas, CA
Tel: 408-433-9950

Mexico
Guadalajara, Jalisco
Tel: 52-33-3123-2141

Europe

Southern Europe
Paris, France
Tel: 33-1-4646-1006

Sasso Marconi, Italy
Tel: 39-051-939111

Central Europe
Landsberg, Germany
Tel: 49-8191-3350800

Kamen, Germany
Tel: 49-2307-438110

Northern Europe
Bishop's Stortford, United Kingdom
Tel: 44-1279-460122

Espoo, Finland
Tel: 358-9-5406-5000

Asia

Northeast Asia
Hong Kong
Tel: 852-2305-1168

Shenzhen, China
Tel: 86-755-2518-1306

Beijing, China
Tel: 86-10-5829-1711

Shanghai, China
Tel: 86-21-6447-0707

Taipei, Taiwan
Tel: 886-2-27528585

Southeast Asia
Singapore
Tel: 65-6586-1900

Penang, Malaysia
Tel: 60-4-6430200

Bangalore, India
Tel: 91-806-53-76817

Note: KEMET reserves the right to modify minor details of internal and external construction at any time in the interest of product improvement. KEMET does not assume any responsibility for infringement that might result from the use of KEMET Capacitors in potential circuit designs. KEMET is a registered trademark of KEMET Electronics Corporation.

Other KEMET Resources

Tools	
Resource	Location
Configure A Part: CapEdge	http://capacitoredge.kemet.com
SPICE & FIT Software	http://www.kemet.com/spice
Search Our FAQs: KnowledgeEdge	http://www.kemet.com/keask
Electrolytic LifeCalculator	http://www.kemet.com:8080/elc

Product Information	
Resource	Location
Products	http://www.kemet.com/products
Technical Resources (Including Soldering Techniques)	http://www.kemet.com/technicalpapers
RoHS Statement	http://www.kemet.com/rohs
Quality Documents	http://www.kemet.com/qualitydocuments

Product Request	
Resource	Location
Sample Request	http://www.kemet.com/sample
Engineering Kit Request	http://www.kemet.com/kits

Contact	
Resource	Location
Website	www.kemet.com
Contact Us	http://www.kemet.com/contact
Investor Relations	http://www.kemet.com/ir
Call Us	1-877-MyKEMET
Twitter	http://twitter.com/kemetcapacitors

Disclaimer

All product specifications, statements, information and data (collectively, the "Information") in this datasheet are subject to change. The customer is responsible for checking and verifying the extent to which the Information contained in this publication is applicable to an order at the time the order is placed.

All Information given herein is believed to be accurate and reliable, but it is presented without guarantee, warranty, or responsibility of any kind, expressed or implied.

Statements of suitability for certain applications are based on KEMET Electronics Corporation's ("KEMET") knowledge of typical operating conditions for such applications, but are not intended to constitute – and KEMET specifically disclaims – any warranty concerning suitability for a specific customer application or use. The Information is intended for use only by customers who have the requisite experience and capability to determine the correct products for their application. Any technical advice inferred from this Information or otherwise provided by KEMET with reference to the use of KEMET's products is given gratis, and KEMET assumes no obligation or liability for the advice given or results obtained.

Although KEMET designs and manufactures its products to the most stringent quality and safety standards, given the current state of the art, isolated component failures may still occur. Accordingly, customer applications which require a high degree of reliability or safety should employ suitable designs or other safeguards (such as installation of protective circuitry or redundancies) in order to ensure that the failure of an electrical component does not result in a risk of personal injury or property damage.

Although all product-related warnings, cautions and notes must be observed, the customer should not assume that all safety measures are indicated or that other measures may not be required.