

ALM-GN001

GNSS Filter-LNA Front-End Module



Data Sheet

Description

Avago Technologies' ALM-GN001 is an ultra low-noise GNSS front-end module that combines a low-noise amplifier (LNA) with a GNSS FBAR pre-LNA filter. The LNA uses Avago Technologies' proprietary GaAs Enhancement-mode pHEMT process to achieve high gain with very low noise figure and high linearity. Noise figure distribution is very tightly controlled. A CMOS-compatible shutdown pin is included either for turning the LNA on/off, or for current adjustment. The integrated filter utilizes an Avago Technologies' leading-edge FBAR filter for exceptional rejection at Cellular, DCS, PCS and WLAN band frequencies. Bypass functionality with an external RF switch is possible with separate RF switching.

The low noise figure and high gain, coupled with low current consumption make it suitable for use in critical low-power GNSS applications or during low-battery situations.

Component Image

Surface Mount (2.3 x 1.7 x 0.85) mm³ 6-lead DFN

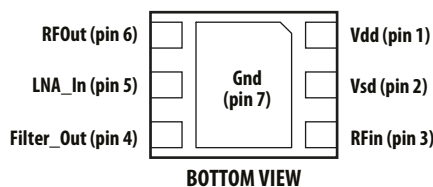
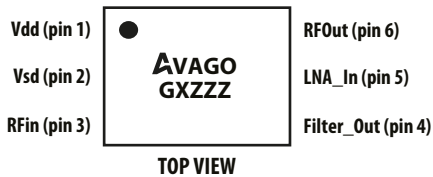

Package marking provides orientation and identification

- "A" = Avago special character
- "G" = Product code
- "X" = Month and year of manufacture
- "ZZZ" = Last 3 digits of assembly lot identification

Attention: Observe precautions for handling electrostatic sensitive devices.
 ESD Machine Model = 70 V
 ESD Human Body Model = 300 V
 Refer to Avago Application Note A004R: Electrostatic Discharge, Damage and Control.

Features

- Operating Temperature Range -40 to +85°C
- Very Low Noise Figure: 1.54dB typ.
- Exceptional Cell/DCS/PCS/WLAN-Band rejection
- Advanced GaAs E-pHEMT & FBAR Technology
- Shutdown current : < 1µA
- CMOS compatible shutdown pin (Vsd)
- ESD : > 1kV at RFin pin
- 0.85mm typical thickness
- Adjustable bias current via single control voltage pin
- Small package dimension: (2.3 x 1.7 x 0.85) mm³
- Meets MSL3, Lead-free and halogen free

Target Specifications (Typical performance @ 25° C)

At 1.575GHz, Vdd = 2.7V, Idd = 6mA

- Gain = 16dB
- NF = 1.54dB
- IIP3 = 2.5dBm, IP1dB = -4dBm
- S11 = -8dB, S22 = -13dB
- Rejection @ 824 – 849MHz: 58dBc
- Rejection @ 880 – 924MHz: 56dBc
- Rejection @ 1710 – 1785MHz: 47dBc
- Rejection @ 1850 – 1910MHz: 51dBc
- Rejection @ 2400 – 2570MHz: 51dBc

Application

- GNSS Front-end Module

Application Circuit

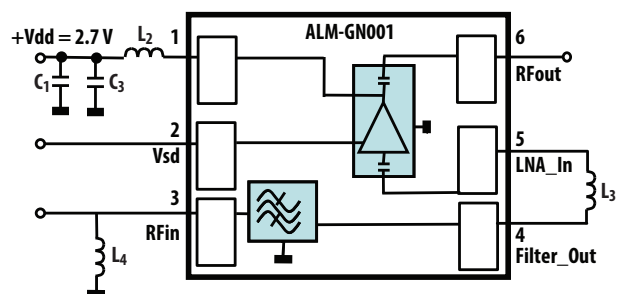

Absolute Maximum Rating ^[1] $T_A = 25^\circ\text{C}$

Symbol	Parameter	Units	Absolute Max.
Vdd	Device Drain to Source Voltage ^[2]	V	4.0
Idd	Drain Current ^[2]	mA	15
Pin,max	CW RF Input Power (Vdd = 2.7V, Idd = 6mA)	dBm	15
Pdiss	Total Power Dissipation ^[4]	mW	60
Tj	Junction Temperature	°C	150
T _{STG}	Storage Temperature	°C	-65 to 150

Thermal Resistance ^[3](Vdd = 2.7 V, Idd = 6mA), $\theta_{jc} = 107^\circ\text{C/W}$

Notes:

1. Operation of this device in excess of any of these limits may cause permanent damage.
2. Assuming DC quiescent conditions.
3. Thermal resistance measured using Infra-Red measurement technique.
4. Board (module belly) temperature TB is 25°C. Derate 9.4 mW/°C for TB > 143°C.

Electrical Specifications

TA = 25°C, Freq=1.575GHz and 1.602GHz, measured on board as in Figure 1

Table 1. Performance at Vdd = Vsd = 2.7V, Idd = 6mA (R2 = 12kOhm) nominal operating conditions

Symbol	Parameter and Test Condition	Unit	at 1.575GHz			at 1.602GHz		
			Min.	Typ.	Max.	Min.	Typ.	Max.
Passband Performance								
G	Gain	dB	14.2	16.0	18	12.7	14.9	17
NF ^[1]	Noise Figure	dB	-	1.54	2.2	-	1.84	2.5
IP1dB	Input 1dB Compressed Power	dBm	-	-4	-	-	-4	-
IIP3 ^[2]	Input 3rd Order Intercept Point (2-tone at Fc +/-1MHz)	dBm	-	2.5	-	-	2.5	-
S11	Input Return Loss	dB	-	-8	-	-	-10	-
S22	Output Return Loss	dB	-	-13	-	-	-11	-
S12	Reverse Isolation	dB	-	-24	-	-	-25	-
Idd	Supply DC current at Shutdown voltage Vsd=2.7V	mA	2.8	6	10.5	-	-	-
Ish	Shutdown Current at Vsd = 0V	uA	-	0.5	-	-	-	-
Out of Band Performance								
B5 / CDMA / GSM850 / B8 / GSM900 Rejection	Worst-case relative to 1.575GHz within (824-924)MHz band, tested at 924MHz	dBc	42	56	-	-	-	-
B3 / GSM1700 Rejection	Worst-case relative to 1.575GHz within (1710-1785)MHz band, tested at 1710MHz	dBc	36	47	-	-	-	-
B2 / CDMA1900 / GSM1900 Rejection	Worst-case relative to 1.575GHz within (1850-1910)MHz band, tested at 1850MHz	dBc	42	51	-	-	-	-
ISM / WiMax Rejection	Worst-case relative to 1.575GHz within (2400-2570)MHz band, tested at 2400MHz	dBc	42	51	-	-	-	-
IP1dB _{890MHz}	Input 1dB gain compression interferer signal level at 890MHz	dBm	-	>40	-	-	-	-
IP1dB _{1710MHz}	Input 1dB gain compression interferer signal level at 1710MHz	dBm	-	38	-	-	-	-
IP1dB _{1850MHz}	Input 1dB gain compression interferer signal level at 1850MHz	dBm	-	39	-	-	-	-
OOB IIP3 ^[3]	Out of Band Input 3rd Order Intercept Point (2-tone at 1712.7MHz and 1850MHz)	dBm	-	48	-	-	-	-

Table 2. Performance at Vdd = Vsd = 1.8V, Idd = 6mA (R2 = 00hm) nominal operating conditions

Symbol	Parameter and Test Condition	Units	at 1.575GHz (Typ.)
Passband Performance			
G	Gain	dB	15
NF [1]	Noise Figure	dB	1.59
IP1dB	Input 1dB Compressed Power	dBm	-9.8
IIP3 [2]	Input 3rd Order Intercept Point (2-tone at Fc +/- 1MHz)	dBm	2.1
S11	Input Return Loss	dB	-9
S22	Output Return Loss	dB	-19
S12	Reverse Isolation	dB	-23
Idd	Supply DC current at Shutdown (SD) voltage Vsd=1.8V	mA	6
Ish	Shutdown Current at Vsd = 0V	uA	0.5
Out of Band Performance			
B5 / CDMA / GSM850 / B8 / GSM900 Rejection	Worst-case relative to 1.575GHz within (824-924)MHz band, tested at 924MHz	dBc	55
B3 / GSM1700 Rejection	Worst-case relative to 1.575GHz within (1710-1785)MHz band, tested at 1710MHz	dBc	46
B2 / CDMA1900 / GSM1900 Rejection	Worst-case relative to 1.575GHz within (1850-1910)MHz band, tested at 1850MHz	dBc	50
ISM / WiMax Rejection	Worst-case relative to 1.575GHz within (2400-2570)MHz band, tested at 2400MHz	dBc	50

Notes:

1. Losses from demoboard deembedded
2. 1.575GHz IIP3 test condition: FRF1 = 1574MHz, FRF2 = 1576MHz with input power of -20dBm per tone measured at the worst case side band
3. 1.575GHz IIP3 test condition: FRF1 = 1712.7MHz, FRF2 = 1850MHz with input power of 10dBm per tone measured at the worst case side band

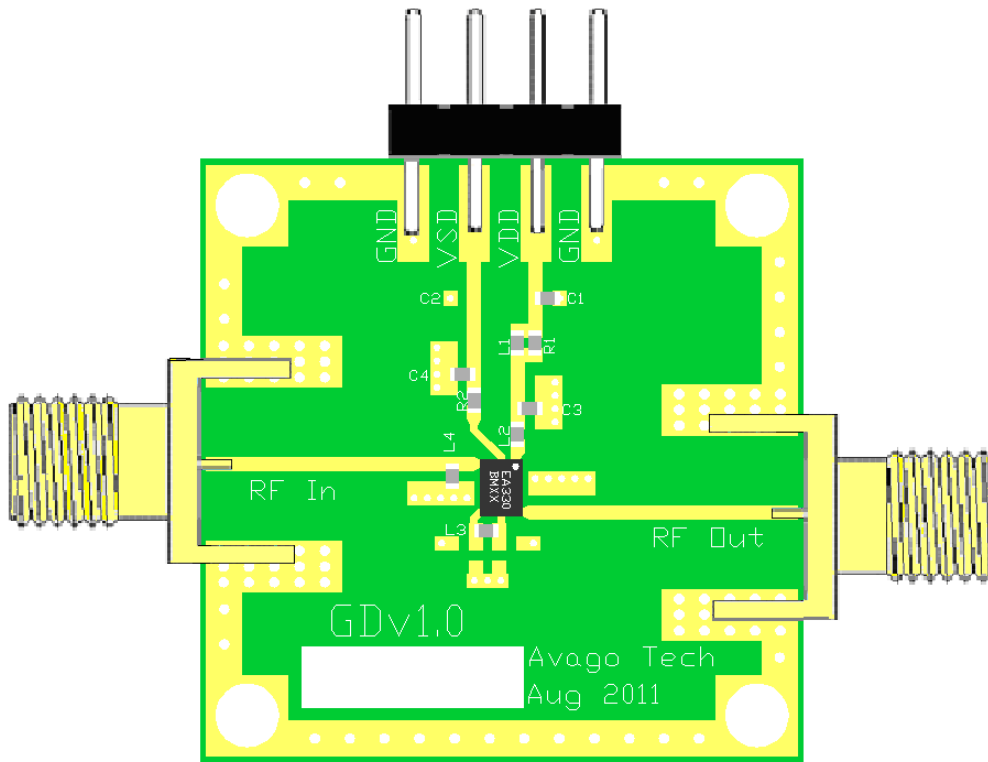

Circuit Symbol	Size	Description
L1	0402	22nH Inductor (Taiyo Yuden HK100522NJ-T)
L2	0402	3.9nH Inductor (Taiyo Yuden HK10053N9S-T)
L3	0402	9.1nH Inductor (Taiyo Yuden HK10059N1J-T)
L4	0402	12nH Inductor (Taiyo Yuden HK100512NJ-T)
C1	0402	0.1uF Capacitor (Murata GRM155R71C104KA88D)
C3	0402	15pF Capacitor (Murata GJM1555C1H150JB01D)
C4	0402	6.8pF Capacitor (Murata GJM1555C1H6R8DB01D)
R1	0402	12Ohm Resistor (Kamaya RMC1/16S-120JTH)
R2	0402	12kOhm Resistor (Kamaya RMC1/16SK123FTH)

Figure 1. Demoboard and application circuit components table

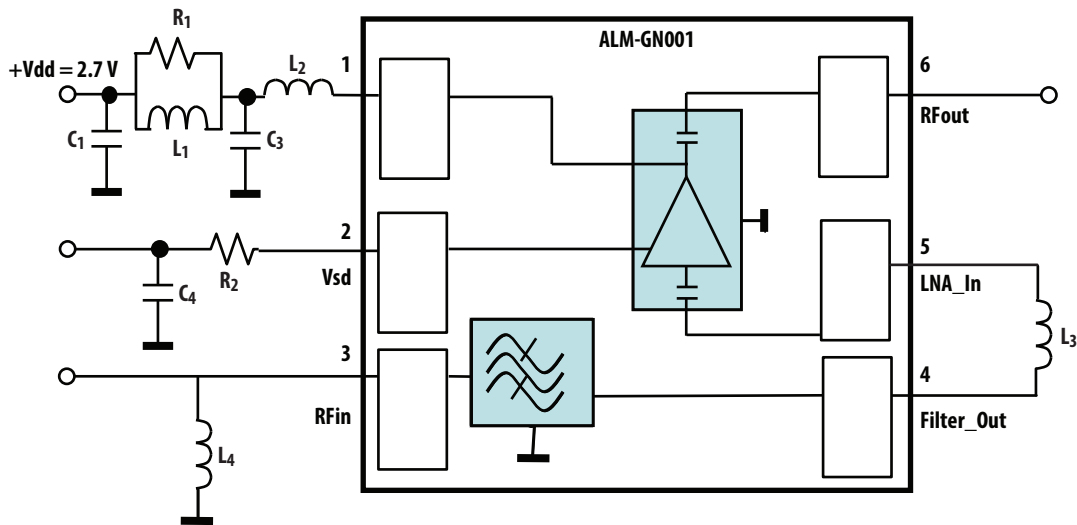

Figure 2. Application Circuit

Notes:

1. RF input match is achieved by a single shunt inductor, L4. It is used to match the module for best NF and S11.
2. The output of the module is matched.
3. Best noise performance is obtained using high-Q wirewound inductors. Low noise figures are also obtainable with standard 0402 chip inductors.
4. C1 is for low frequency stability and C3 is the bypass capacitor for RF matching and linearity.
5. Bias control is achieved by either varying the Vsd voltage with R2, or fixing the Vsd voltage to Vdd and adjusting R2 for the desired current. The component values specified in Table 1 results in 6 mA current drain. Noise figure, Gain and linearity can be further improved by increasing the bias current.
6. L1 and R1 isolates the demoboard from external disturbances during measurement. They are not needed in actual application. Likewise, C4 mitigate the effect of external noise pickup on the Vsd line. This component is not required in actual operation.
7. L3 matches the filter output to the input of the LNA for optimum noise performance.

ALM-GN001 Typical Performance Curves at 25° C

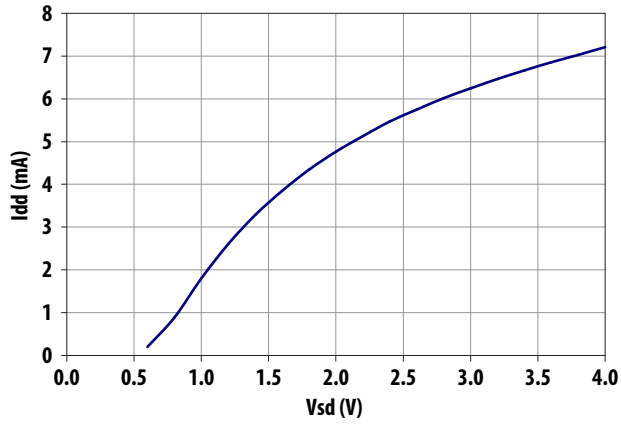

Figure 3. I_{dd} vs V_{sd} for $V_{dd} = 2.7$ V, $R_2 = 12$ kOhm

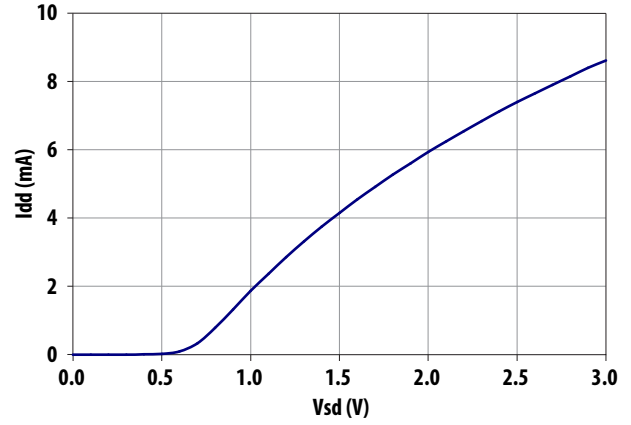

Figure 4. I_{dd} vs V_{sd} for $V_{dd} = 1.8$ V, $R_2 = 0$ Ohm

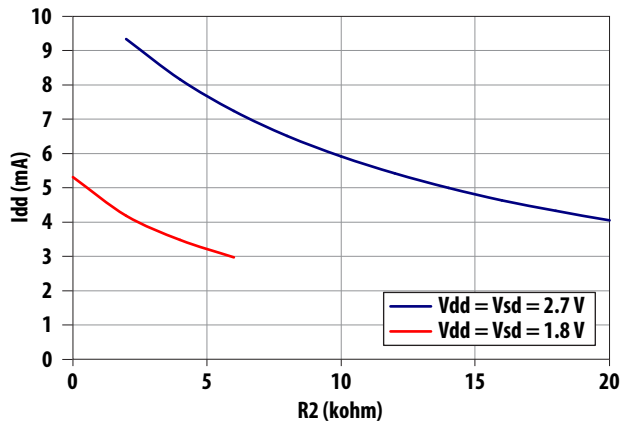

Figure 5. I_{dd} vs R_2 for $V_{dd} = V_{sd} = 2.7$ V and $V_{dd} = V_{sd} = 1.8$ V

ALM-GN001 Typical Performance Curves at 25° C

Unless otherwise stated, all measurements were made with the demoboard and components on Fig 1 at $V_{dd} = V_{sd} = 2.7V$, $I_{dd} = 6mA$, $R_2 = 12k\Omega$

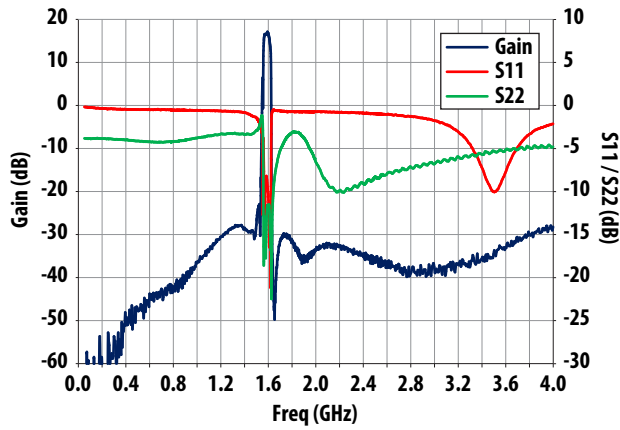

Figure 6a. Typical S-Parameter Plot

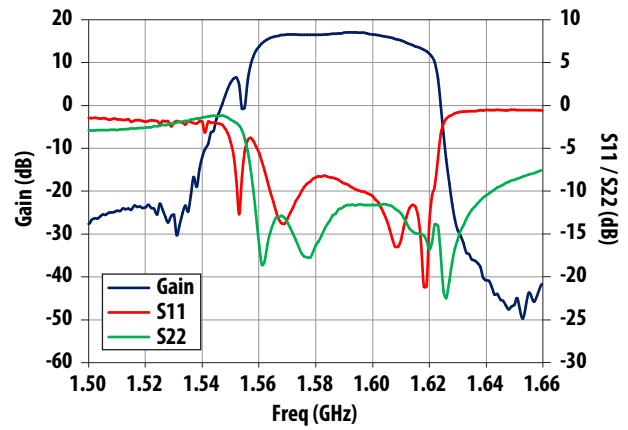

Figure 6b. Passband response of typical S-Parameter Plot

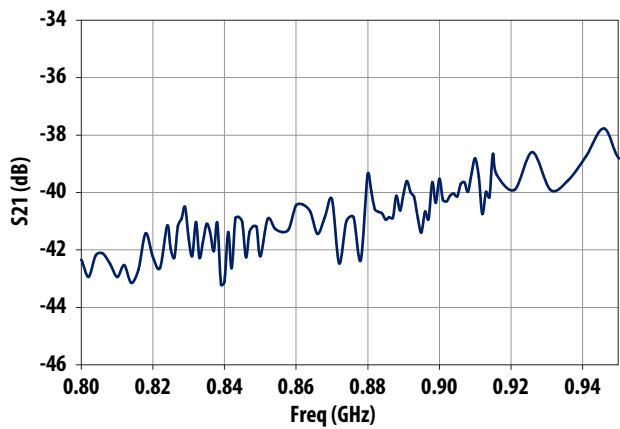

Figure 6c. S21 plot for (800-940) MHz

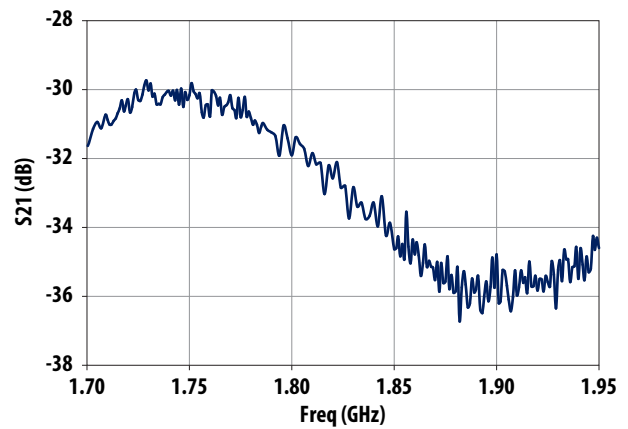

Figure 6d. S21 plot for (1700 - 1950) MHz

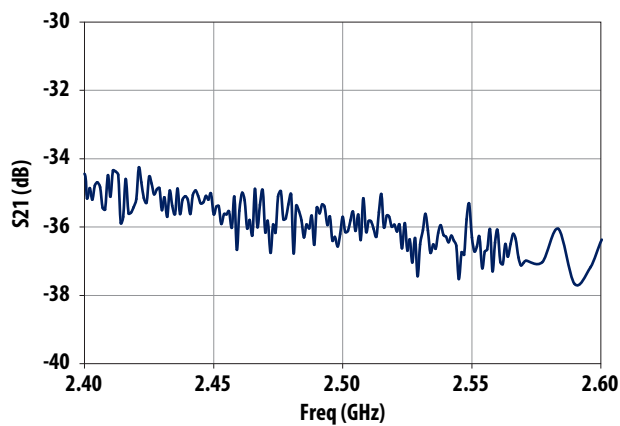

Figure 6e. S21 plot for (2400 - 2600) MHz

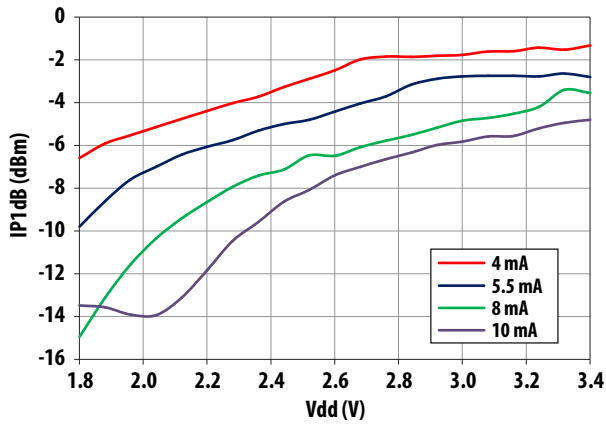

Figure 7. IP1dB vs. Vdd

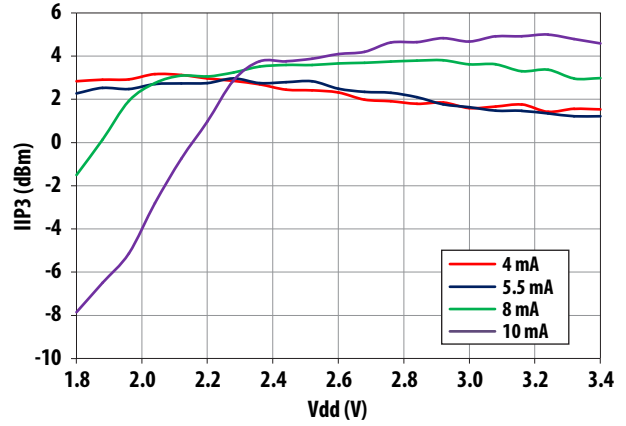

Figure 8. IIP3 vs. Vdd

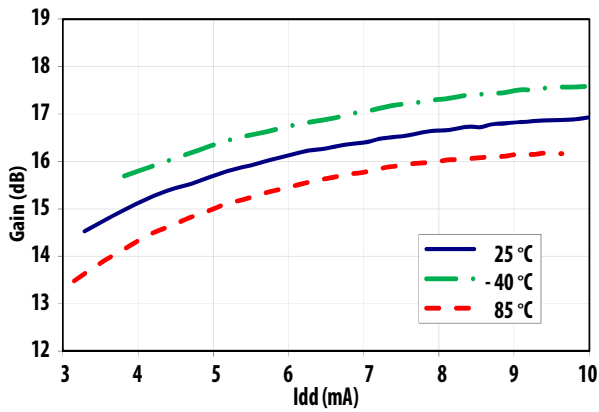

Figure 9. Gain@1.575GHz vs. Idd

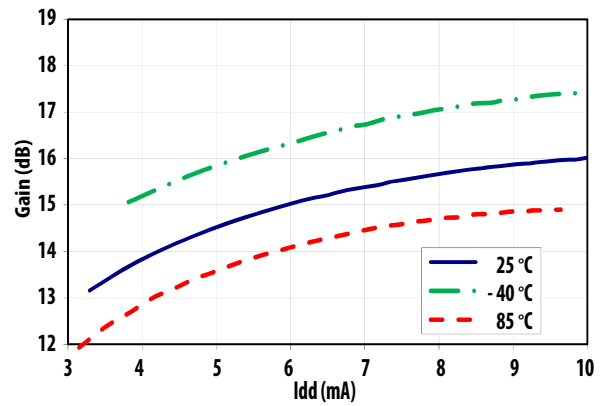

Figure 10. Gain@1.602GHz vs. Idd

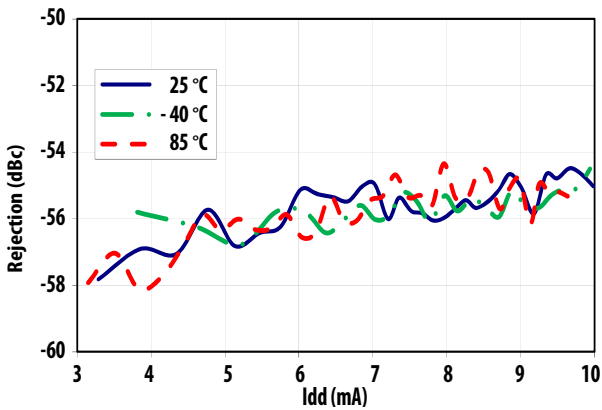

Figure 11. Rejection at 924MHz relative to 1.575GHz vs. Idd

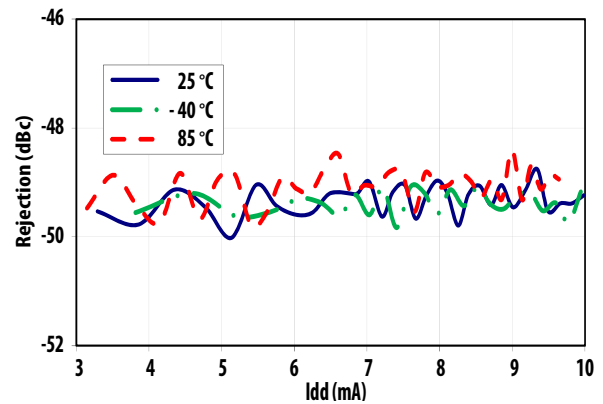

Figure 12. Rejection at 1710MHz relative to 1.575GHz vs. Idd

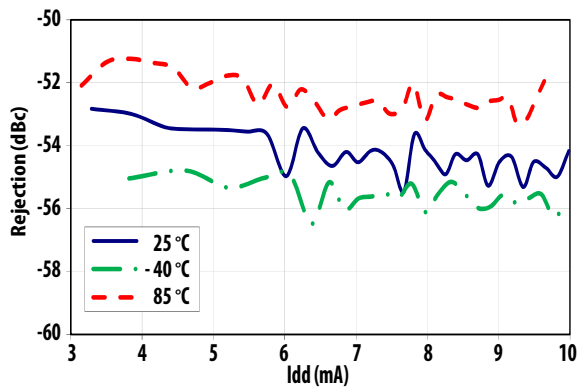

Figure 13. Rejection at 1850MHz relative to 1.575GHz vs. Idd

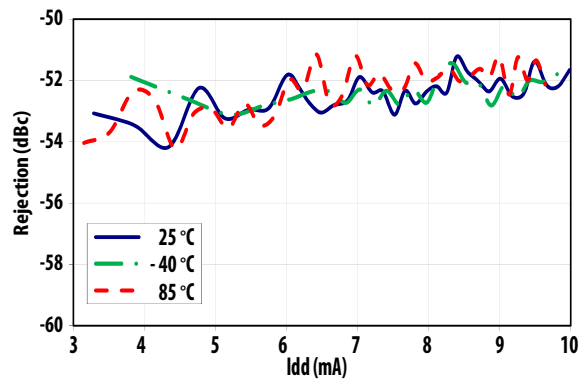

Figure 14. Rejection at 2400MHz relative to 1.575GHz vs. Idd

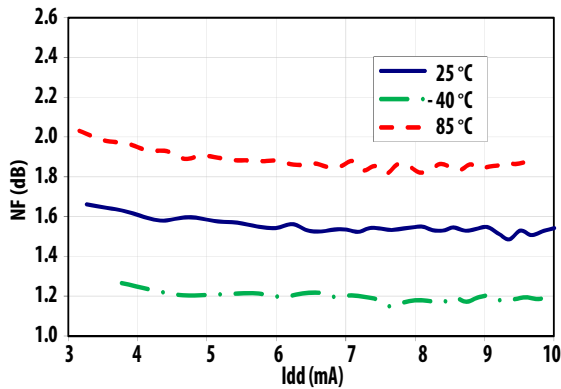

Figure 15. NF@1.575GHz vs. Idd

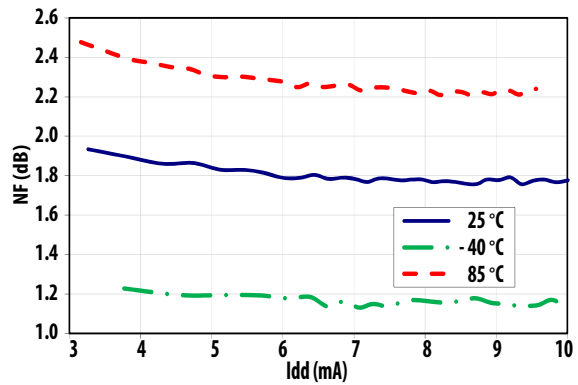

Figure 16. NF@1.602GHz vs. Idd

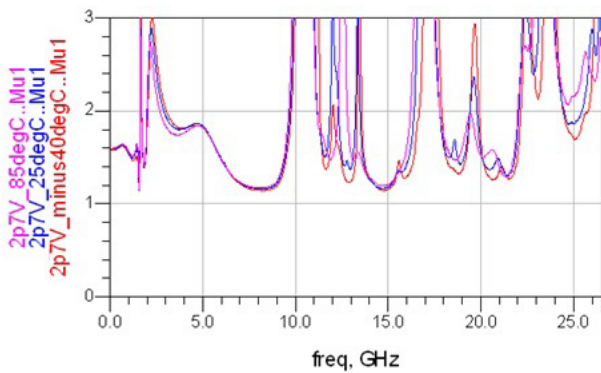

Figure 17. Edwards-Sinsky Output Stability Factor (Mu)

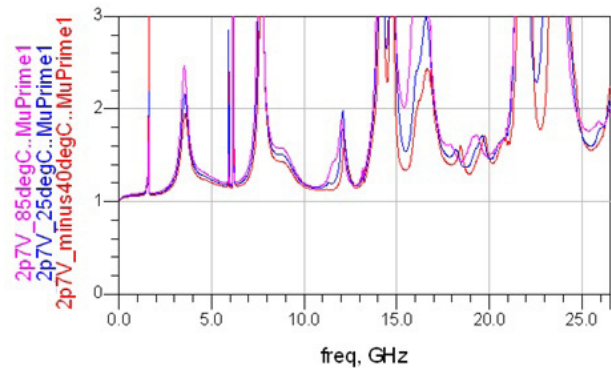

Figure 18. Edwards-Sinsky Input Stability Factor (Mu')

ALM-GN001 Typical Performance Curves at 25° C

Unless otherwise stated, all measurements were made with the demoboard and components on Fig 1 at $V_{dd} = V_{sd} = 1.8V$, $I_{dd} = 6mA$, $R_2 = 0\Omega$

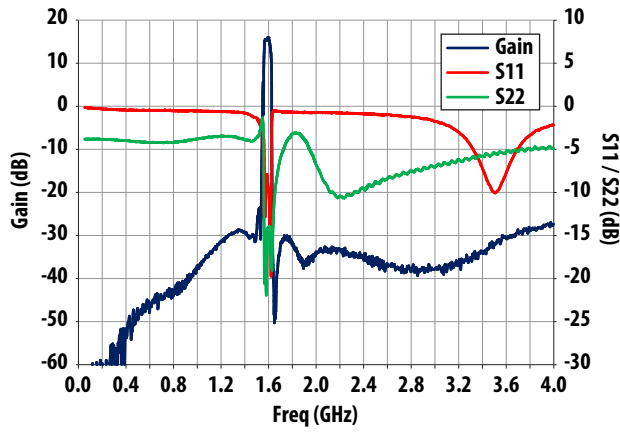

Figure 19a. Typical S-Parameter Plot

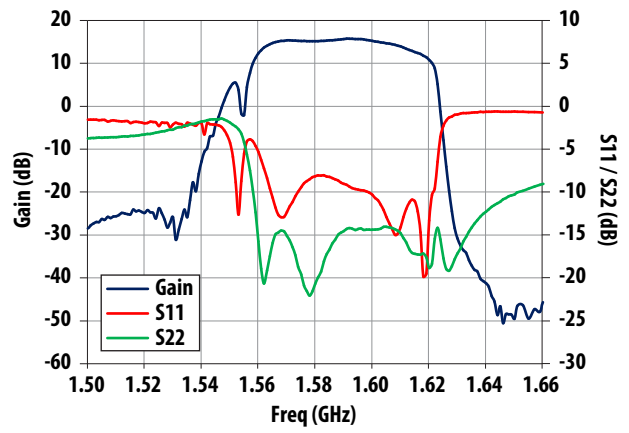

Figure 19b. Passband response of typical S-Parameter Plot

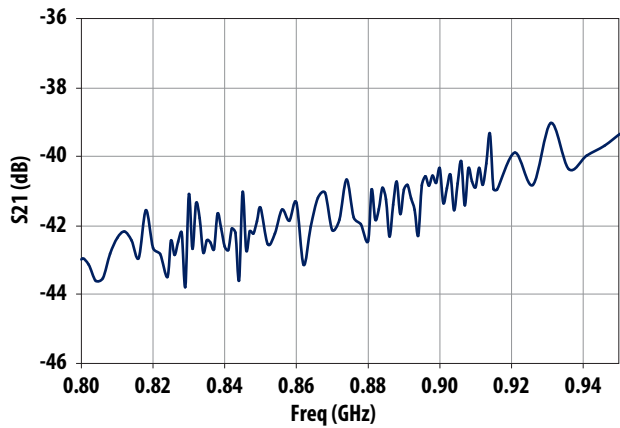

Figure 19c. S21 plot for (800-950) MHz

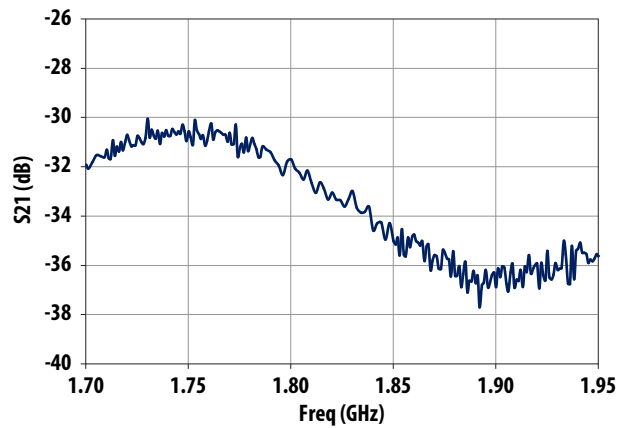

Figure 19d. S21 plot for (1700 - 1950) MHz

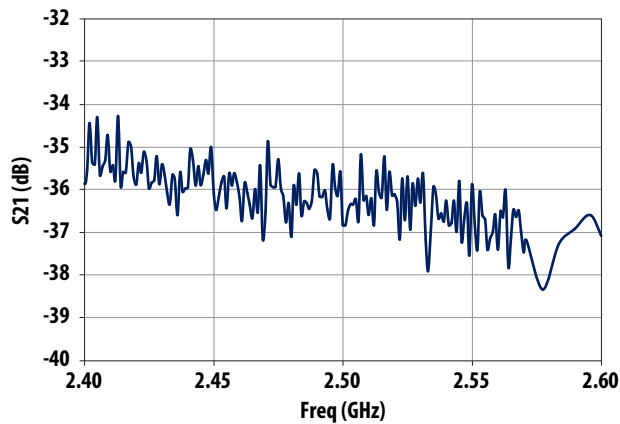

Figure 19e. S21 plot for (2400 - 2600) MHz

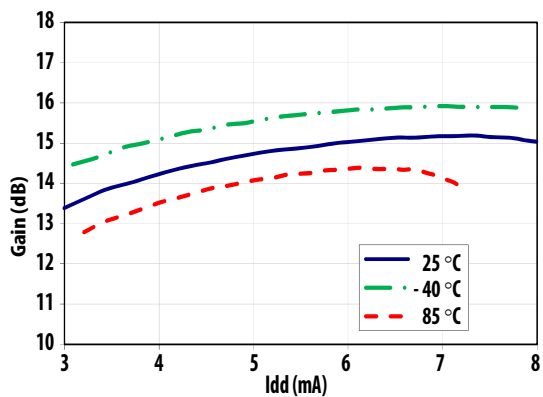

Figure 20. Gain@1.575GHz vs. Idd

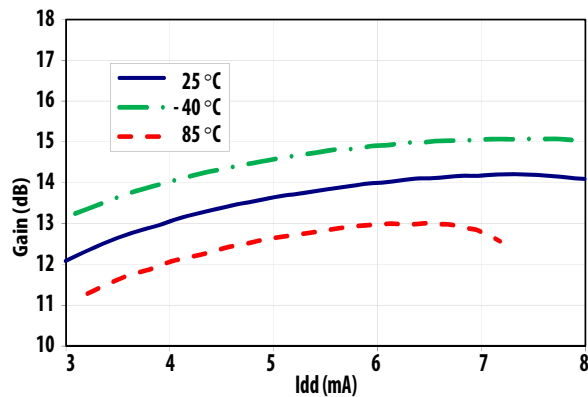

Figure 21. Gain@1.602GHz vs. Idd

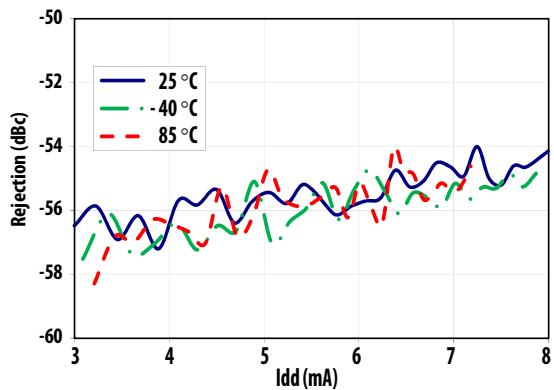

Figure 22. Rejection at 924MHz relative to 1.575GHz vs. Idd

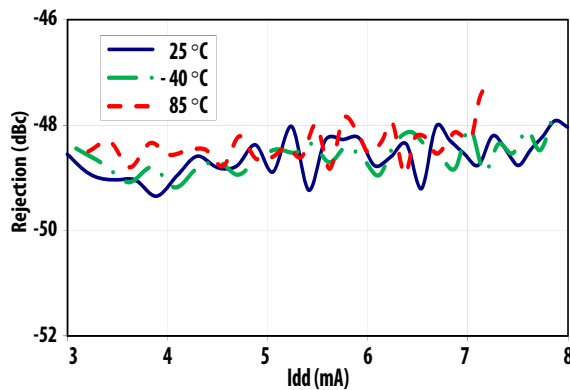

Figure 23. Rejection at 1710MHz relative to 1.575GHz vs. Idd

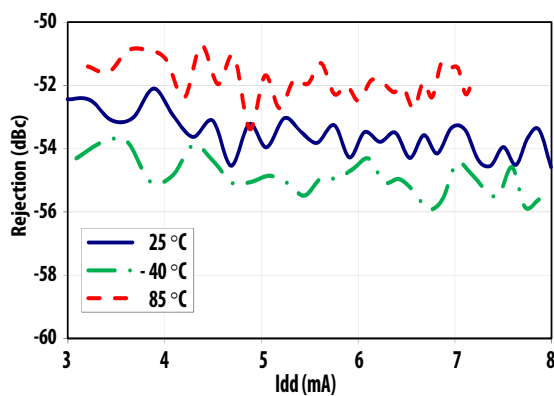

Figure 24. Rejection at 1850MHz relative to 1.575GHz vs. Idd

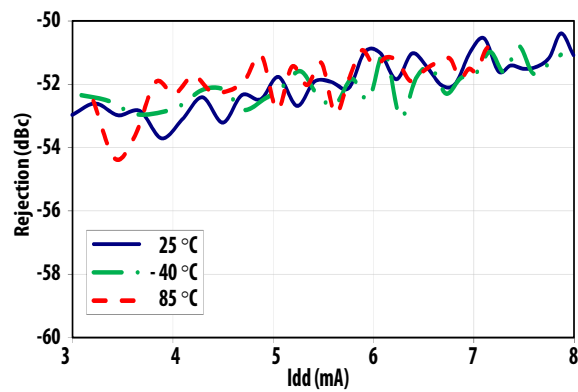

Figure 25. Rejection at 2400MHz relative to 1.575GHz vs. Idd

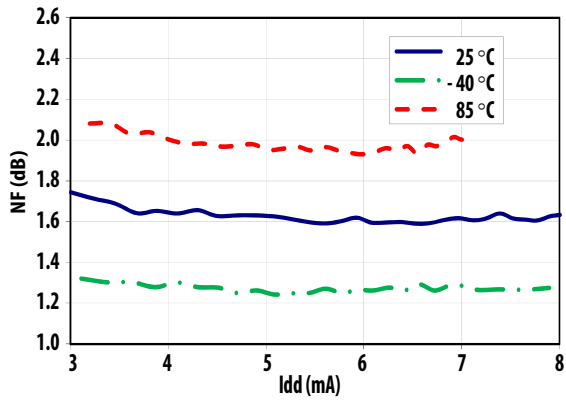

Figure 26. NF@1.575GHz vs. Idd

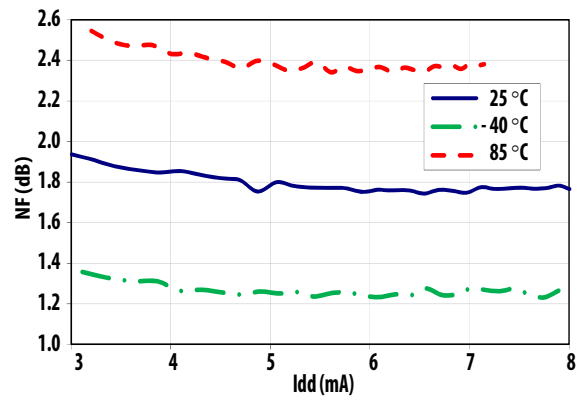

Figure 27. NF@1.602GHz vs. Idd

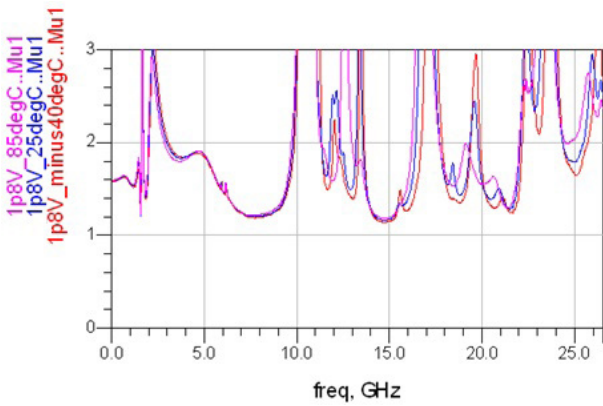

Figure 28. Edwards-Sinsky Output Stability Factor (μ)

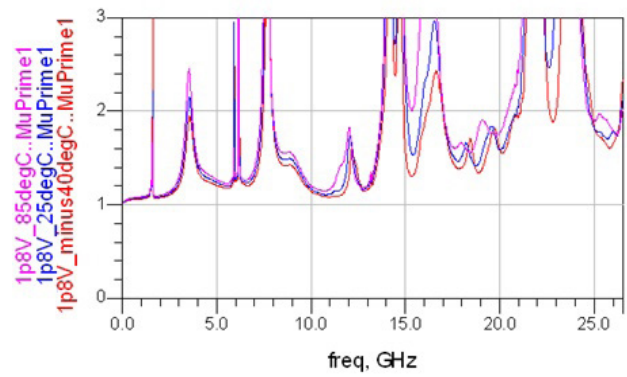

Figure 29. Edwards-Sinsky Input Stability Factor (μ')

ALM-GN001 Scattering Parameter and Measurement Reference Planes

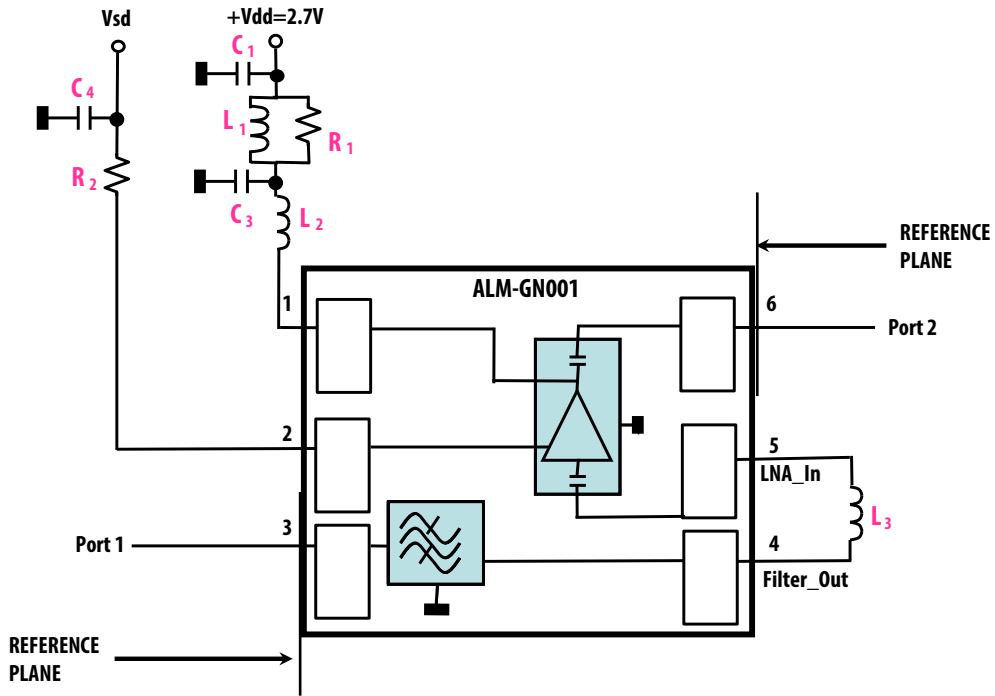

Figure 30. Circuit used for measuring small-signal and noise parameters of packaged part. Data is deembedded to reference planes as shown. Component values are as detailed in Figure 1.

The S- and Noise Parameters are measured using a coplanar waveguide PCB with 10 mils Rogers® RO4350. Figure 30 shows the input and output reference planes. The circuit values are as indicated in Figure 1.

ALM-GN001 Typical Scattering Parameters at 25°C, Vdd = 2.7V, Idd = 6mA

Freq (GHz)	S11		S21		S12		S22	
	Mag.	Ang.	Mag.	Ang.	Mag.	Ang.	Mag.	Ang.
0.05	0.00	-2.95	-84.67	106.69	-87.10	-52.96	-3.97	-3.09
0.1	-0.02	-5.69	-62.93	-35.08	-75.02	20.90	-3.97	-6.31
0.2	-0.03	-11.33	-54.44	-55.74	-86.43	135.37	-3.98	-12.84
0.3	-0.04	-17.02	-48.77	-71.22	-73.28	114.09	-4.02	-19.42
0.4	-0.09	-22.75	-45.45	-86.71	-69.87	97.21	-4.20	-26.34
0.5	-0.10	-28.39	-43.43	-99.38	-66.93	80.99	-4.29	-33.05
0.6	-0.12	-33.92	-42.66	-112.02	-63.92	72.24	-4.37	-39.43
0.7	-0.13	-39.56	-42.99	-116.61	-61.38	63.09	-4.36	-45.75
0.8	-0.14	-45.20	-43.46	-109.74	-59.49	52.46	-4.21	-52.88
0.825	-0.14	-46.63	-43.30	-105.37	-58.53	48.70	-4.16	-54.84
0.9	-0.15	-50.96	-41.73	-93.79	-56.74	40.99	-3.96	-61.44
1.0	-0.16	-56.90	-38.19	-91.75	-54.05	28.08	-3.80	-72.42
1.1	-0.21	-61.06	-35.23	-93.26	-51.39	18.60	-3.52	-83.56
1.2	-0.22	-67.91	-32.33	-102.54	-48.17	3.24	-3.30	-102.42
1.3	-0.26	-75.81	-30.24	-116.68	-44.44	-17.09	-3.10	-129.98
1.4	-0.34	-86.72	-30.67	-124.94	-40.24	-46.19	-2.80	-173.09
1.5	-0.85	-108.68	-24.48	-66.49	-35.50	-95.74	-1.54	114.18
1.565	-17.91	38.07	16.24	-110.31	-22.32	-167.16	-10.17	23.96
1.575	-6.90	-82.36	15.96	177.23	-23.86	124.01	-18.48	42.06
1.6	-10.73	-35.47	16.35	11.35	-24.19	-45.27	-12.33	38.68
1.605	-10.38	-81.98	15.52	-27.44	-23.85	-84.09	-11.04	46.7
1.7	-0.29	-65.12	-36.25	169.11	-46.66	-114.00	-4.40	44.06
1.8	-0.29	-82.52	-35.36	154.97	-44.13	-146.08	-2.70	-5.48
1.885	-0.30	-91.23	-33.51	172.21	-44.93	-164.11	-3.24	-37.99
1.9	-0.31	-92.58	-32.86	172.50	-45.15	-166.93	-3.51	-42.85
2.0	-0.34	-100.68	-30.33	159.79	-46.68	-173.97	-6.09	-65.86
2.1	-0.38	-108.17	-30.07	143.52	-46.76	-174.81	-8.91	-72.06
2.2	-0.43	-115.35	-30.80	130.68	-46.13	-179.04	-10.45	-67.56
2.3	-0.49	-122.46	-31.95	121.13	-45.25	175.30	-10.59	-62.16
2.4	-0.56	-129.59	-33.33	114.76	-44.67	168.39	-10.10	-60.07
2.5	-0.64	-137.02	-34.88	111.89	-44.19	158.42	-9.47	-60.71
3.0	-1.55	177.92	-37.18	138.77	-42.02	107.31	-7.19	-76.90
3.5	-7.96	33.13	-35.79	80.59	-39.45	-25.93	-5.86	-95.05
4.0	-1.73	-136.65	-33.52	-158.73	-37.59	-163.26	-4.90	-111.52
4.5	-1.03	-178.98	-27.60	161.31	-36.40	152.87	-4.17	-126.46
5.0	-0.89	154.69	-24.80	133.97	-35.47	127.17	-3.57	-140.83
6.0	-0.98	119.36	-22.05	89.45	-34.32	96.11	-2.71	-170.78
7.0	-1.11	80.31	-17.36	41.03	-30.67	65.72	-1.72	157.82
8.0	-4.52	24.75	-12.09	-23.95	-24.52	19.38	-0.96	132.78
9.0	-3.02	105.79	-15.55	-136.30	-24.62	-103.92	-0.91	112.35
10.0	-1.05	65.41	-19.24	176.72	-22.17	128.79	-4.75	78.33
11.0	-0.94	41.50	-24.48	96.48	-22.07	-25.96	-1.62	109.91
12.0	-1.03	23.95	-29.19	47.31	-23.33	-89.92	-0.40	77.39
13.0	-2.32	7.16	-32.35	-37.87	-20.74	-156.70	-0.42	56.87
14.0	-3.90	8.48	-30.17	150.27	-19.46	121.79	-0.66	45.71
15.0	-2.68	4.92	-29.74	49.48	-24.24	58.74	-1.10	41.50
16.0	-3.37	-8.71	-39.80	21.62	-29.61	35.55	-0.95	33.05
17.0	-1.86	-17.27	-42.25	-0.01	-35.64	21.84	-0.59	19.73
18.0	-1.58	-26.97	-37.68	94.24	-33.28	65.02	-0.47	12.75
19.0	-2.34	-35.06	-33.41	69.81	-31.13	39.25	-0.46	3.67
20.0	-3.96	-58.58	-30.89	43.44	-29.57	29.65	-0.60	-10.38

ALM-GN001 Typical Scattering Parameters at 25°C, Vdd = 1.8V, Idd = 6mA

Freq (GHz)	S11		S21		S12		S22	
	Mag.	Ang.	Mag.	Ang.	Mag.	Ang.	Mag.	Ang.
0.05	-0.01	-2.90	-89.76	-43.54	-70.24	89.83	-3.98	-3.02
0.1	-0.02	-5.72	-64.10	-36.48	-84.70	113.65	-3.97	-6.31
0.2	-0.03	-11.34	-54.68	-62.25	-84.22	37.14	-3.98	-12.81
0.3	-0.04	-17.02	-50.02	-76.83	-74.13	94.24	-4.02	-19.39
0.4	-0.09	-22.76	-46.48	-89.55	-72.15	80.29	-4.20	-26.27
0.5	-0.10	-28.39	-44.61	-102.18	-66.40	70.11	-4.29	-32.96
0.6	-0.12	-33.94	-43.93	-112.43	-64.78	61.54	-4.36	-39.33
0.7	-0.13	-39.58	-44.27	-117.84	-61.33	55.93	-4.35	-45.67
0.8	-0.14	-45.19	-44.74	-109.66	-59.23	49.04	-4.21	-52.75
0.8275	-0.14	-46.64	-44.44	-105.97	-58.32	45.09	-4.16	-54.68
0.9	-0.15	-50.97	-43.02	-93.07	-56.48	36.19	-3.97	-61.29
1.0	-0.16	-56.90	-39.42	-91.06	-53.86	25.50	-3.83	-72.14
1.1	-0.21	-61.04	-36.42	-92.49	-50.73	17.11	-3.60	-83.11
1.2	-0.22	-67.88	-33.56	-101.59	-47.38	2.21	-3.47	-101.64
1.3	-0.26	-75.78	-31.55	-115.08	-43.69	-18.60	-3.44	-128.52
1.4	-0.34	-86.67	-31.83	-120.91	-39.75	-46.39	-3.42	-170.76
1.5	-0.86	-108.65	-25.11	-66.05	-35.20	-94.63	-2.25	115.18
1.565	-15.95	38.68	15.09	-111.01	-21.58	-168.67	-11.5	15.83
1.575	-6.45	-84.89	14.75	176.60	-23.14	121.53	-21.62	27.23
1.6	-9.60	-41.92	14.96	11.21	-23.04	-46.33	-14.75	29.55
1.605	-9.69	-89.13	14.21	-26.72	-22.79	-83.88	-13.31	42.96
1.7	-0.29	-65.08	-37.16	-179.54	-43.95	-108.72	-5.09	45.43
1.8	-0.29	-82.48	-35.52	160.12	-42.49	-144.74	-2.85	-7.41
1.885	-0.30	-91.19	-33.82	171.57	-44.02	-164.11	-3.39	-42.25
1.9	-0.31	-92.53	-33.28	171.09	-44.49	-166.38	-3.69	-47.37
2.0	-0.34	-100.61	-31.26	158.30	-46.38	-170.25	-6.53	-70.48
2.1	-0.38	-108.08	-31.16	143.06	-46.37	-170.03	-9.48	-75.41
2.2	-0.43	-115.26	-31.92	131.28	-45.73	-174.06	-11.00	-69.53
2.3	-0.49	-122.36	-32.99	122.50	-45.06	178.05	-11.04	-63.41
2.4	-0.57	-129.50	-34.27	116.47	-44.45	171.00	-10.46	-60.99
2.5	-0.64	-136.90	-35.60	112.95	-44.37	159.98	-9.77	-61.56
3.0	-1.56	178.08	-38.75	126.35	-42.96	99.53	-7.34	-77.49
3.5	-7.98	32.77	-40.83	42.97	-37.92	-39.37	-5.94	-95.58
4.0	-1.74	-136.45	-32.30	-153.18	-37.30	-156.18	-4.95	-112.19
4.5	-1.04	-178.93	-28.23	167.16	-38.41	168.47	-4.19	-127.33
5.0	-0.91	154.29	-26.40	142.50	-40.21	168.39	-3.56	-142.06
6.0	-1.65	123.18	-17.57	108.37	-21.32	120.24	-3.34	-169.93
7.0	-1.17	82.58	-16.25	42.63	-25.65	57.09	-1.79	158.67
8.0	-4.78	25.47	-11.90	-22.96	-22.93	18.99	-1.00	133.30
9.0	-2.94	105.37	-16.36	-136.52	-26.22	-94.09	-0.97	113.08
10.0	-1.15	67.55	-27.80	-148.36	-29.65	-26.56	-2.63	90.38
11.0	-0.95	42.55	-22.95	125.22	-24.78	-45.57	-2.07	112.23
12.0	-1.15	25.18	-29.00	52.10	-22.79	-103.38	-0.43	77.33
13.0	-2.45	10.48	-32.88	-76.63	-19.42	-170.80	-0.55	56.85
14.0	-3.74	8.86	-26.20	136.31	-18.36	111.33	-0.75	46.60
15.0	-3.26	6.43	-30.15	51.20	-24.65	50.57	-0.99	42.83
16.0	-2.35	-2.50	-32.03	21.22	-28.49	26.15	-0.79	33.26
17.0	-1.59	-17.07	-40.70	16.62	-34.83	28.66	-0.53	19.57
18.0	-1.47	-26.07	-37.98	71.92	-33.50	52.12	-0.41	12.65
19.0	-2.25	-33.83	-33.69	62.48	-31.48	34.45	-0.47	3.51
20.0	-3.96	-57.18	-31.14	40.72	-30.02	28.28	-0.68	-10.73

ALM-GN001 Typical Noise Parameters at 25°C,**Freq = 1.575 GHz, Vdd = 2.7V, Idd = 6mA**

Freq (GHz)	NFmin (dB)	GAMMA OPT		
		Mag	Ang	Rn/50
1.565	1.85	0.218	124.4	0.1898
1.575	1.39	0.099	40.3	0.1792
1.602	1.57	0.188	28.3	0.2350

Freq = 1.575 GHz, Vdd = 1.8V, Idd = 6mA

Freq (GHz)	NFmin (dB)	GAMMA OPT		
		Mag	Ang	Rn/50
1.565	1.91	0.208	121.5	0.1978
1.575	1.41	0.130	45.7	0.1928
1.602	1.61	0.170	38.6	0.2446

Note: The exceptional noise figure performance of the ALM-GN001 is due to its highly optimized design. Figure 30 shows the circuit and reference planes for the measurement.

Ordering Information

Part Number	No. of Devices	Container
ALM-GN001-TR1G	3000	7" Reel
ALM-GN001-BLKG	100	Antistatic Bag

Package Dimensions

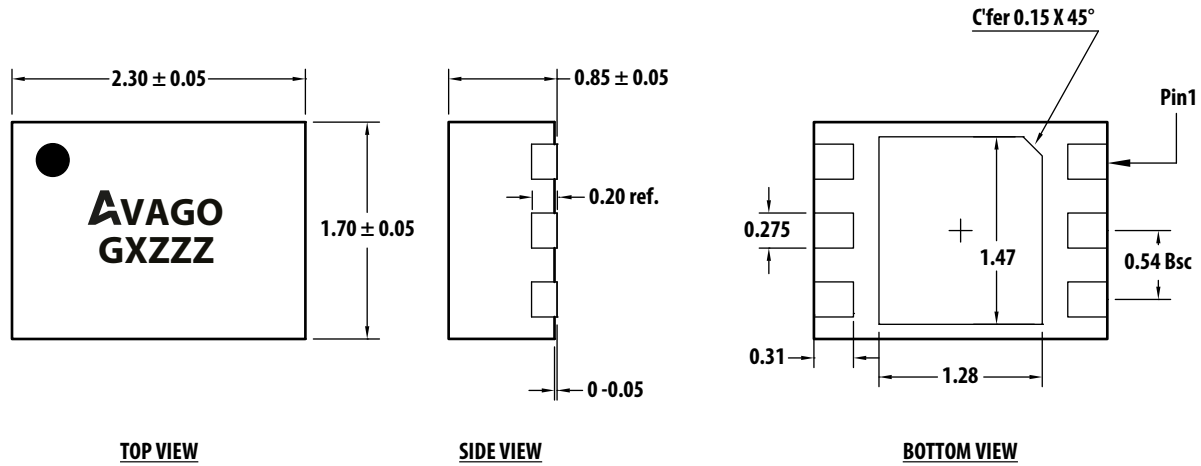

Notes:

1. All dimensions are in millimeters.
2. Dimensions are inclusive of plating.
3. Dimensions are exclusive of mold flash and metal burr.

PCB Land Patterns and Stencil Design

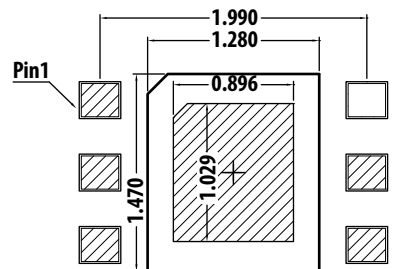
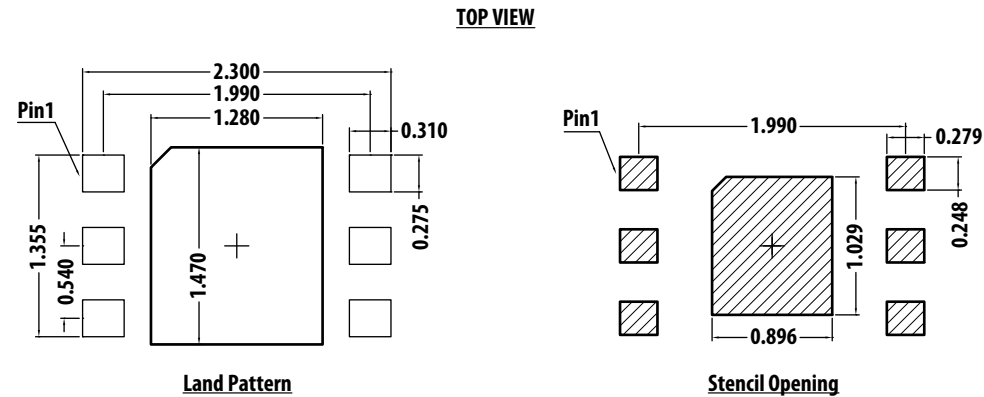

Notes:

1. All dimensions are in millimeters.
2. Recommended 4 mil stencil thickness.
3. All tolerances for the dimensions of the land pattern are $\pm 50\mu\text{m}$.

Device Orientation

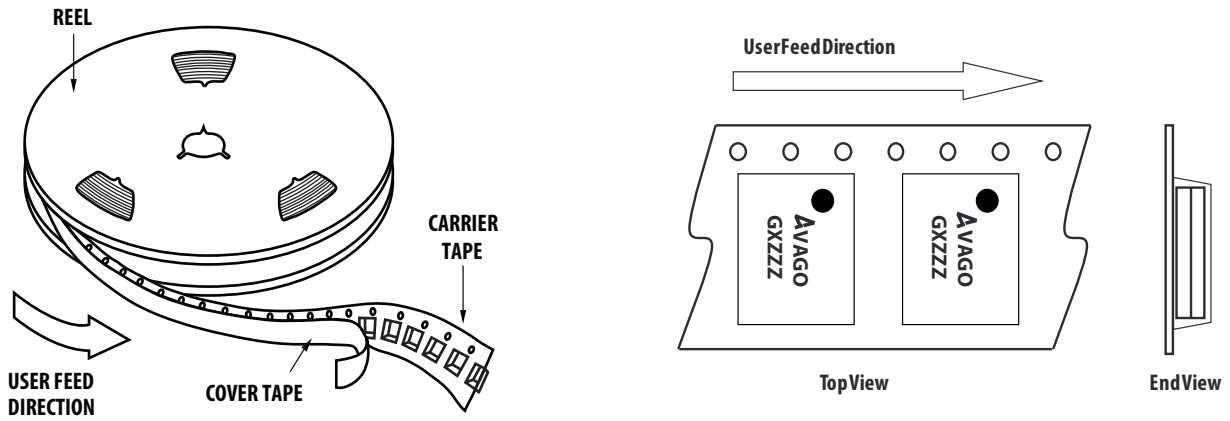

Tape Dimensions

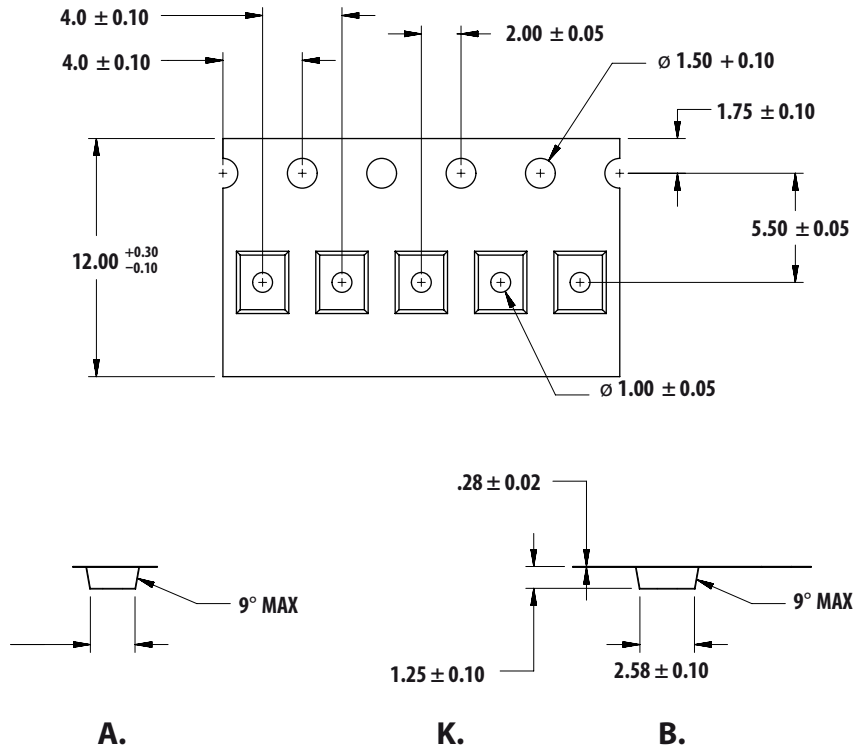

Note: All dimensions are in millimeters

Reel Dimensions (7" reel)

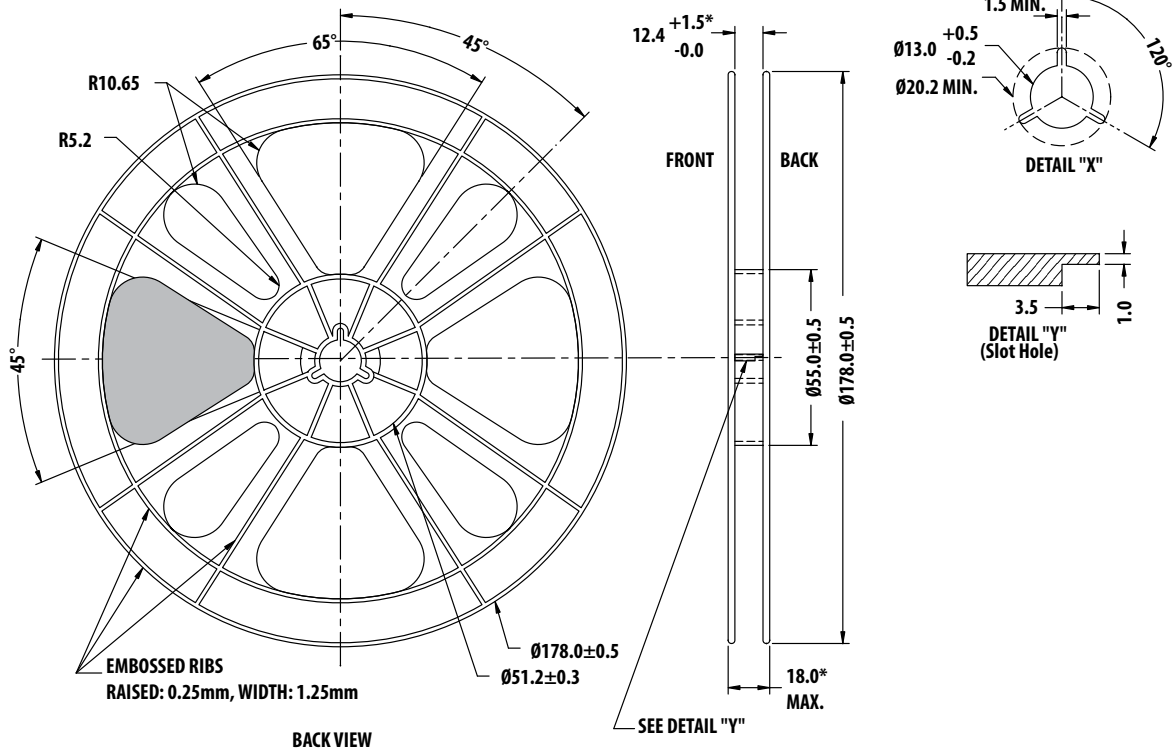
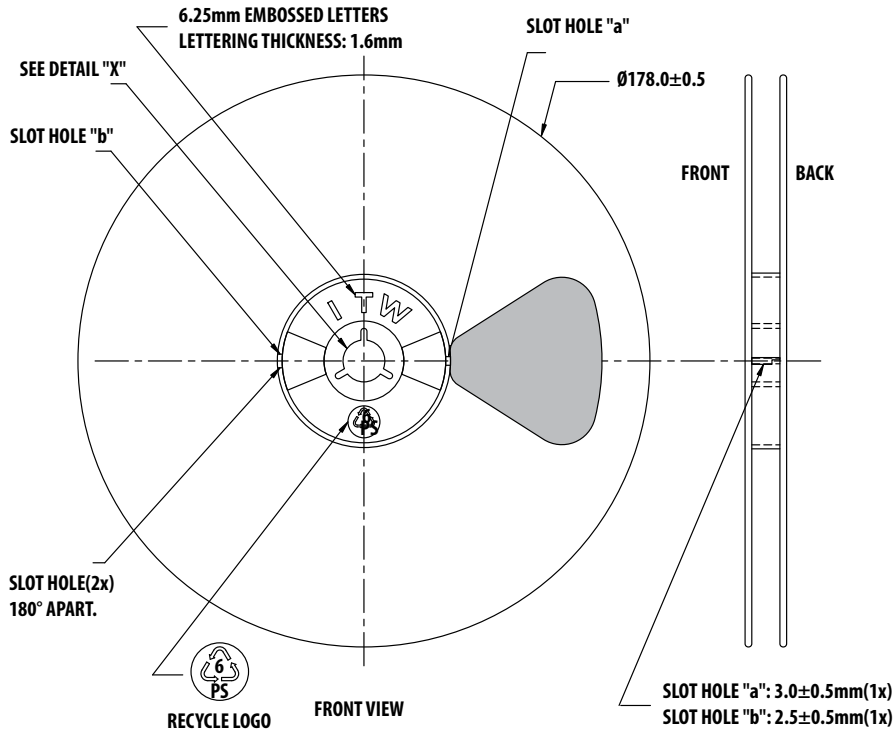

Solder Paste recommendation

The soldering and reflow profile recommended is from JEDEC standard JSTD020D-01. Refer to the JEDEC standard for latest updates.

The recommended solder for mounting surface mount package is Sn63 (63% SN 37% Pb) because it is a eutectic compound with a melting point (183°C) not high enough to exceed the standard operating limit of the devices. Furthermore, it is low enough to avoid damaging circuitry during solder reflow operations.

The recommended lead free solder for SMT reflow is Sn-Ag-Cu (95.5% Tin / 3.8% Silver/ 0.7% Copper). This lead free solder paste has a melting point of 217°C (423°F), the ternary eutectic of Sn-Ag-Cu system, giving it the advantage of being the lowest melting lead free alternative. This temperature is still low enough to avoid damaging the internal circuitry during solder reflow operations provided the time of exposure at peak reflow temperature versus time is shown in Figure 31.

The solder paste used in this evaluation is RX 303-92 SK HO(S) by Nihon Handa. Profile in Figure 31 is recommended in automated reflow process to ensure reliable finished joints. However, profile will vary among different solder paste from different manufacturers. Other factors that may affect the profile includes the density and type of components on the board, type of solder and type of board or substrate material being used. The profile shows the actual temperature that should occur on the surface of a test board at or near a central solder joint. During this type of reflow soldering, the circuit board and solder joints tend to heat first. The components on the board are then heated by conduction. The circuit because it has a large surface area, absorbs thermal energy more efficiently, and then distributes this heat to the components.

Reflow temperature profiles designed for tin/ lead alloys will need to be revised accordingly to cater for the melting point of the lead free solder being 34°C (93°F) higher than that of tin / lead eutectic or near eutectic alloys. Outlined below is a typical convection reflow lead free profile. However, this should only be taken as a guideline from which to start from.

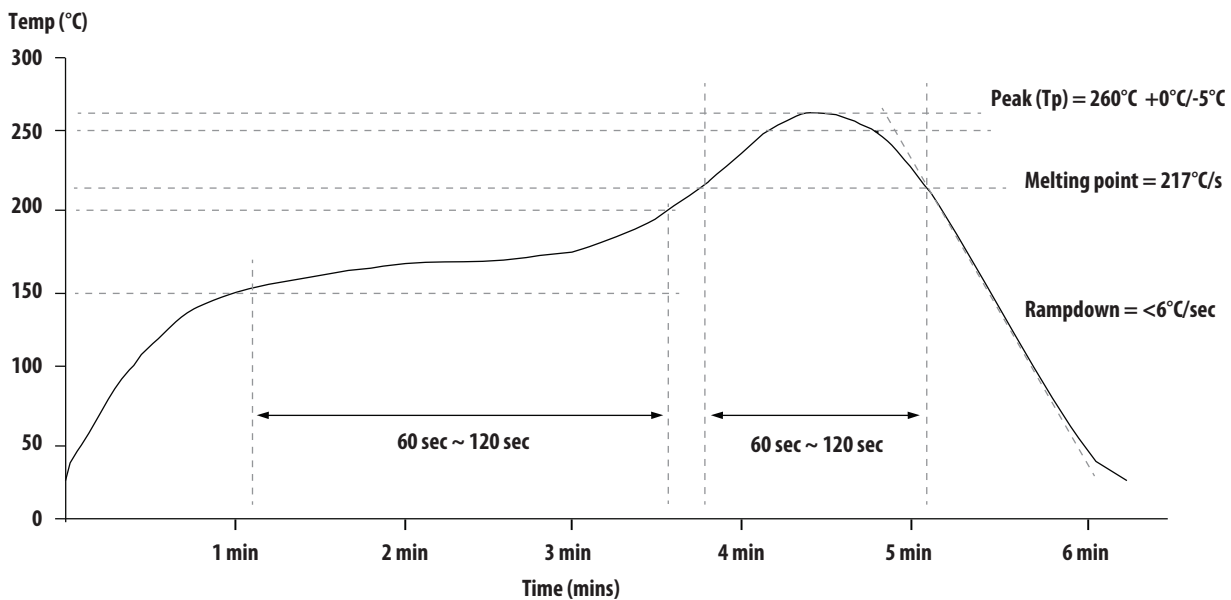

Figure 31. Recommended reflow profile

Remarks

Ramp	Max slope for this zone is limited to 2°C/ sec. Higher than 2°C may result in excessive solder balling and slump.
Preheat	Preheating setting is usually calculated from 100°C to 150°C with typical time setting of between 70-100 seconds. If possible, do not preheat beyond the time setting recommended to prevent excessive oxidation to the solder surface.
Reflow	<p>The peak reflow temperature is calculated by adding ~30°C to the melting point of the solder alloy 92 SK, which melts at 217°C. The peak reflow temperature is $217^{\circ}\text{C} + 30^{\circ}\text{C} = 247^{\circ}\text{C}$ ($-0^{\circ}\text{C} + 5^{\circ}\text{C}$).</p> <p>The time at peak is not critical and usually not measured as it is very dependent on the type of oven used.</p> <p>Time over 217°C is however critical as it will determine the appearance of the solder joints after reflow. Typical time over 217°C for solder alloy 92 is from 40-60 seconds. Longer reflow time may result in dull and gritty solder joints and charring of flux residues.</p> <p>Time below 30 seconds may result in insufficient wetting and poor inter-metallic formation.</p>
Cooling	Max slope for cooling is limited to 4°C/ sec. Cooling at a faster rate may result in cracked solder joints. Slower cooling may result in dull solder joints.

For product information and a complete list of distributors, please go to our web site: www.avagotech.com

Avago, Avago Technologies, and the A logo are trademarks of Avago Technologies in the United States and other countries. Data subject to change. Copyright © 2005-2014 Avago Technologies. All rights reserved.
AV02-4468EN - March 10, 2014

AVAGO
TECHNOLOGIES