

R7 SERIES ROCKER SWITCH

ANTI-VANDAL SWITCHES
DETECTOR SWITCHES
DIP SWITCHES
KEYLOCK SWITCHES
NAVIGATION SWITCHES
PUSHBUTTON SWITCHES
ROCKER SWITCHES
ROTARY SWITCHES
SLIDE SWITCHES
SNAP ACTION SWITCHES
TACTILE SWITCHES
TOGGLE SWITCHES
CAP OPTIONS

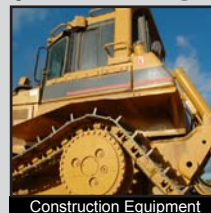

APPLICATIONS / MARKETS

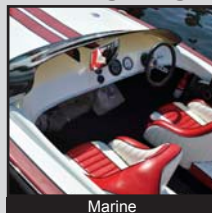

RoHS

SPECIFICATIONS

Contact Rating: 20(8)A @ 125/250VAC, 50/60 Hz, μ T55;
16A @ 6-30VDC, 50/60 Hz, μ T55;
20(8)A @ 125/250VAC, 50/60 Hz, μ T85/T55;
16A @ 6-30VDC, 50/60 Hz, μ T85/T55
Electrical Life: 10,000 Cycles per UL61058
Contact Resistance: 20m Ω Max. initial
Insulation Resistance: 100 M Ω Min. @ 500VDC
Dielectric Strength: 1,500VAC for 1 minute
Operating Temperature: 0°C to 55°C
Storage Temperature: -20°C to 85°C
Agency Approvals: cURus
Contact Arrangement: SP or DP up to 3 positions
Moisture Protection: IP67 to front panel
Panel Thickness: 1.5 - 4.5mm

FEATURES & BENEFITS

- Rated to IP67
- UL Listed
- Ergonomic design
- Solder, faston or screw termination
- LED Illumination options
- Multiple functions
- Many actuator styles

PART NUMBER CONFIGURATOR

Series	No. of Poles	Functions	Terminals	Actuator Style**	Marking**	Lamp Type	Actuator Color**	Ratings/Temp	LED 1 Color	LED 2 Color	Lens Color**
R7	1 - SP 2 - DP	1 - on-off 2 - on-on 3 - on-off-on† 4 - (on)-off 5 - (on)-on 6 - (on)-off-(on) 7 - (on)-off-on 8 - on-(off)	F - Faston 1/4" S - Solder Lug W - Screw	A1 - Hard PC A2 - Hard PC A3 - Hard PC B1 - Soft TPR B2 - Soft TPR B3 - Soft TPR B4 - Soft TPR C1 - Hard PC C2 - Hard PC C3 - Hard PC D1 - PC D2 - PC D3 - PC E1 - Soft TPR E2 - Soft TPR E3 - Soft TPR F1 - Soft TPR F2 - Soft TPR F3 - Soft TPR XX - None	-Sxxx	N - None 1 - 6VDC 2 - 12VDC 3 - 24VDC 4 - 125VAC 5 - 250VAC	B - Black G - Gray X - None	B - 20(8)A @ 125/250VAC, 50/60 Hz, μ T55 D - 16A @ 6-30VDC, 50/60 Hz, μ T55 2 - 20(8)A @ 125/250VAC, 50/60 Hz, μ T85/T55† 4 - 16A @ 6-30VDC, 50/60 Hz, μ T85/T55†	N - None R - Red A - Amber G - Green	N - None R - Red A - Amber G - Green	W - White G - Green X - None

ACTUATOR CONFIGURATOR*

Series	Actuator Style	Actuator Color	Lens Color	Marking
R7	A1 D1 A2 D2 A3 D3 B1 E1 B2 E2 B3 E3 B4 F1 C1 F2 C2 F3 C3 XX	B - Black G - Gray X - None	W - White G - Green X - None	-Sxxx

*You can choose to order just the actuator as a separate part number

() denotes momentary

† Function 3 is used only with ratings options 2 and 4

** When creating a part number for just the switch body, leave the options marked in red out. Use all options in the main part number configurator when ordering both the switch body and actuator.

Specifications subject to change without notice



E-SWITCH®

www.e-switch.com

800.867.2717

2

R7 SERIES ROCKER SWITCH

BODY DIMENSIONS

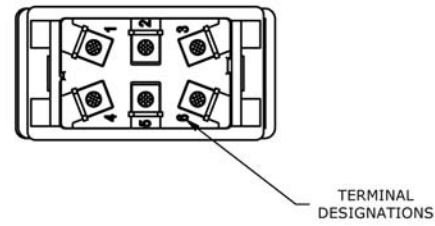
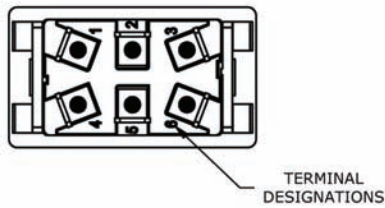
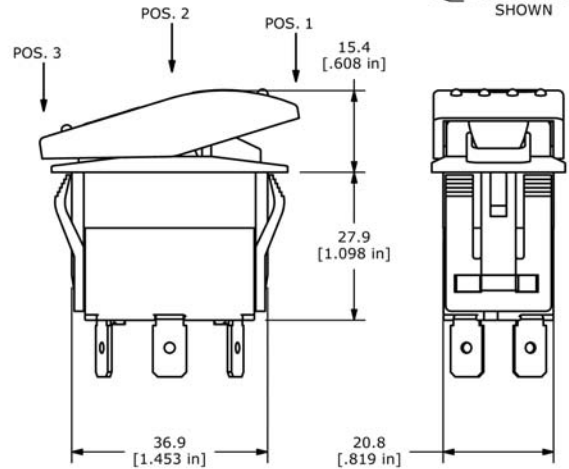
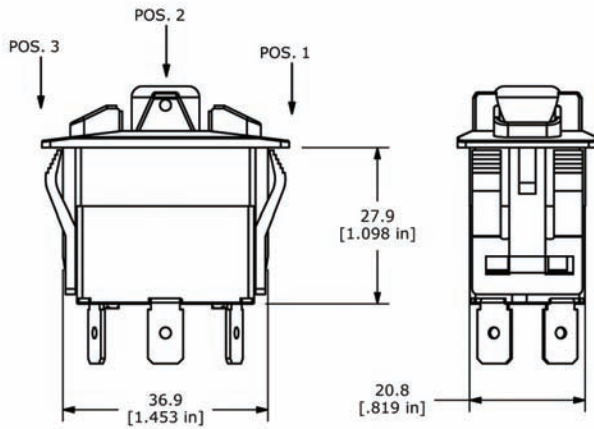
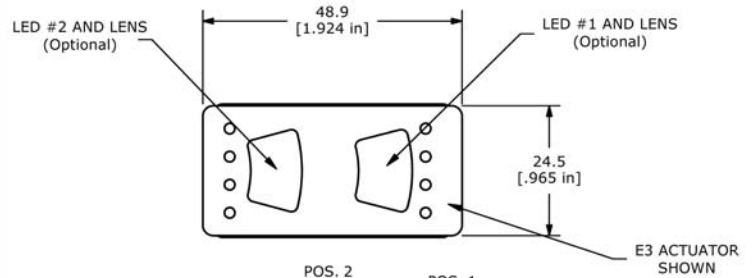
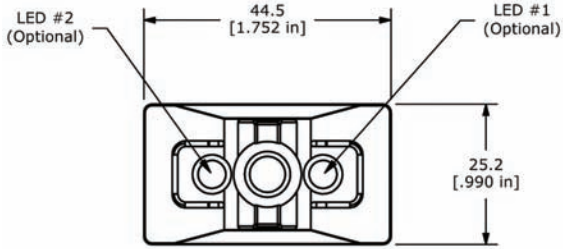

**Double Pole
without actuator**

**Double Pole
with actuator**
(E3 actuator shown)

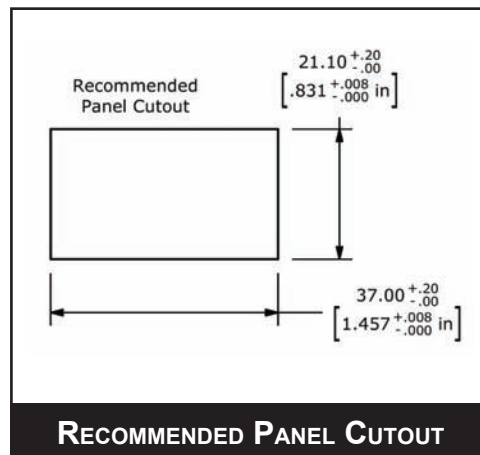

ANTI-VANDAL SWITCHES
DETECTOR SWITCHES
DIP SWITCHES
KEYLOCK SWITCHES
NAVIGATION SWITCHES
PUSHBUTTON SWITCHES
ROCKER SWITCHES
ROTARY SWITCHES
SLIDE SWITCHES
SNAP ACTION SWITCHES
TACTILE SWITCHES
TOGGLE SWITCHES
CAP OPTIONS

TERMINATION OPTIONS

- ANTI-VANDAL SWITCHES
- DETECTOR SWITCHES
- DIP SWITCHES
- KEYLOCK SWITCHES
- NAVIGATION SWITCHES
- PUSHBUTTON SWITCHES
- ROCKER SWITCHES**
- ROTARY SWITCHES
- SLIDE SWITCHES
- SNAP ACTION SWITCHES
- TACTILE SWITCHES
- TOGGLE SWITCHES
- CAP OPTIONS

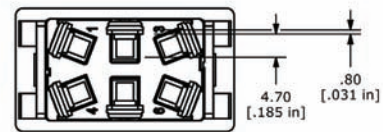
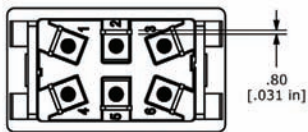
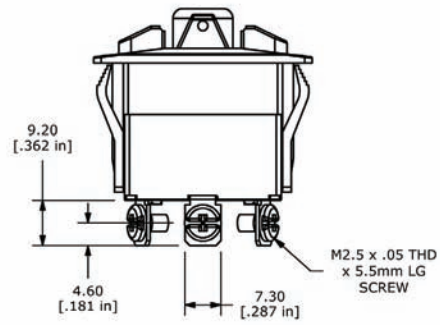
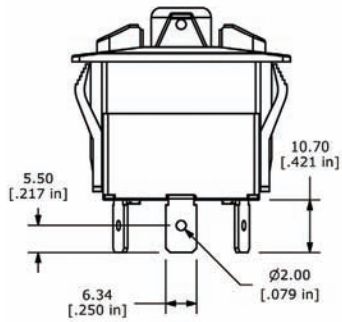
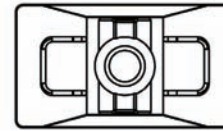
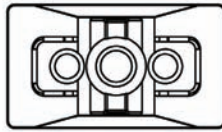

FASTON 1/4"

SCREW

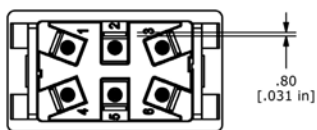
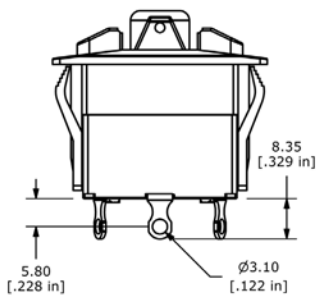
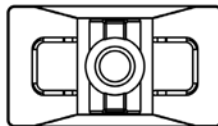

SOLDER



R7 SERIES ROCKER SWITCH

ACTUATOR OPTIONS

A Hard PC



A1



A2



A3

B Soft TPR



B1



B2



B3



B4

C Hard PC



C1



C2



C3

D PC



D1



D2



D3

E Soft TPR



E1



E2

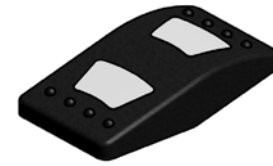

E3

F Soft TPR



F1



F2



F3

TPR = Thermal Plastic Rubber

PC = Polycarbonate

ANTI-VANDAL SWITCHES

DETECTOR SWITCHES

DIP SWITCHES

KEYLOCK SWITCHES

NAVIGATION SWITCHES

PUSHBUTTON SWITCHES

ROCKER SWITCHES

ROTARY SWITCHES

SLIDE SWITCHES

SNAP ACTION SWITCHES

TACTILE SWITCHES

TOGGLE SWITCHES

CAP OPTIONS



E-SWITCH®

www.e-switch.com

800.867.2717

5

R7 SERIES ROCKER SWITCH

SCHEMATICS



SPST
Non Illuminated

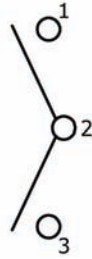

SPDT
Non Illuminated

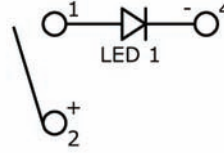

SPST
with LED #1

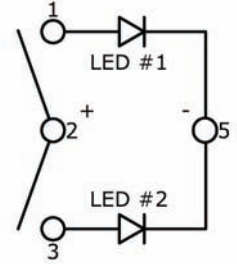

SPDT
with 2 LEDs

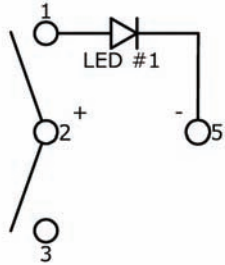

SPDT
with LED #1

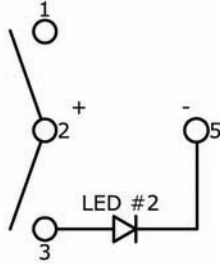

SPDT
with LED #2

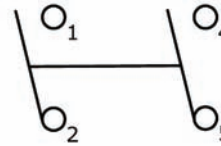

DPST
Non Illuminated

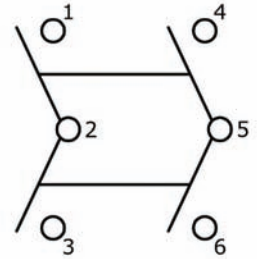

DPDT
Non Illuminated

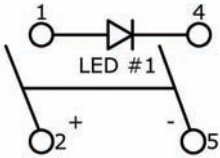

DPST
with LED #1

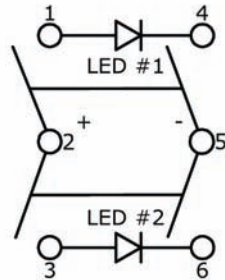

DPDT
with 2 LEDs

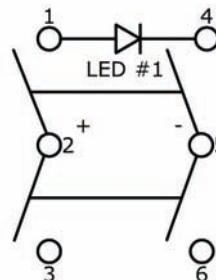

DPDT
with LED #1

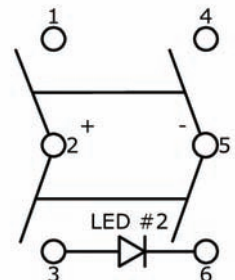

DPDT
with LED #2

