

Aluminum Capacitors SMD (Chip), Very Low Z



Fig. 1

QUICK REFERENCE DATA	
DESCRIPTION	VALUE
Nominal case sizes (L x W x H in mm)	8 x 8 x 10 to 18 x 18 x 21
Rated capacitance range, C_R	4.7 μ F to 10 000 μ F
Tolerance on C_R	\pm 20 %
Rated voltage range, U_R	6.3 V to 100 V
Category temperature range	
6.3 V to 63 V:	-55 °C to +105 °C
100 V:	-40 °C to +105 °C
Endurance test at 105 °C	2000 h to 8000 h
Useful life at 105 °C	2500 h to 10 000 h
Useful life at 40 °C; 1.8 x I_R applied	125 000 h to 500 000 h
Shelf life at 0 V, 105 °C	1000 h
Based on sectional specification	IEC 60384-18/CECC 32300
Climatic category IEC 60068	
6.3 V to 63 V:	55/105/56
100 V:	40/105/56

FEATURES

- Extended useful life: Up to 10 000 h at 105 °C for MAL215099...E3 parts
- Polarized aluminum electrolytic capacitors, non-solid electrolyte, self healing
- SMD-version with base plate, lead (Pb)-free reflow solderable
- Very low impedance, very high ripple current
- Charge and discharge proof, no peak current limitation
- Parts for advanced high temperature reflow soldering according to JEDEC® J-STD-020
- Vibration proof, 4-pin version and 6-pin version
- AEC-Q200 qualified
- High reliability
- Low ESR
- Material categorization: For definitions of compliance please see www.vishay.com/doc?99912

 AUTOMOTIVE
GRADE

RoHS
COMPLIANT

APPLICATIONS

- SMD technology, for high temperature reflow soldering
- Industrial and professional applications
- Automotive, general industrial, telecom
- Smoothing, filtering, buffering

MARKING

- Rated capacitance (in μ F)
- Rated voltage (in V)
- Date code, in accordance with IEC 60062
- Black mark or “-” sign indicating the cathode (the anode is identified by bevelled edges)
- Code indicating group number (Z)

PACKAGING

Supplied in blister tape on reel

SELECTION CHART FOR C_R , U_R , AND RELEVANT NOMINAL CASE SIZES (L x W x H in mm)								
C_R (μF)	U_R (V)							
	6.3	10	16	25	35	50	63	100
4.7	→	→	→	→	→	→	→	10 x 10 x 10
10	→	→	→	→	→	→	→	10 x 10 x 10
22	→	→	→	→	→	→	→	10 x 10 x 10
33	→	→	→	→	→	→	8 x 8 x 10	10 x 10 x 10
47	→	→	→	→	→	→	8 x 8 x 10	-
	→	→	→	→	→	→	10 x 10 x 10	-
68	→	→	→	→	→	8 x 8 x 10	10 x 10 x 10	-
100	→	→	→	→	8 x 8 x 10	10 x 10 x 10	10 x 10 x 12	-
							10 x 10 x 14	-
150	→	→	→	8 x 8 x 10	→	→	12.5 x 12.5 x 13	-
220	→	→	8 x 8 x 10	8 x 8 x 10	10 x 10 x 10	10 x 10 x 12	12.5 x 12.5 x 16	-
						10 x 10 x 14		-
330	→	8 x 8 x 10	8 x 8 x 10	10 x 10 x 10	10 x 10 x 12	12.5 x 12.5 x 13	16 x 16 x 16	-
					10 x 10 x 14			-
470	8 x 8 x 10	8 x 8 x 10	10 x 10 x 10	10 x 10 x 12	12.5 x 12.5 x 13	→	16 x 16 x 21	-
				10 x 10 x 14			18 x 18 x 16	-
680	→	10 x 10 x 10	10 x 10 x 12	12.5 x 12.5 x 13	12.5 x 12.5 x 16	16 x 16 x 16	18 x 18 x 21	-
			10 x 10 x 14					-
1000	10 x 10 x 10	10 x 10 x 12	12.5 x 12.5 x 13	12.5 x 12.5 x 16	16 x 16 x 16	16 x 16 x 21	-	-
		10 x 10 x 14				18 x 18 x 16	-	-
1500	→	12.5 x 12.5 x 13	12.5 x 12.5 x 16	16 x 16 x 16	16 x 16 x 21	18 x 18 x 21	-	-
					18 x 18 x 16	-	-	-
2200	12.5 x 12.5 x 13	12.5 x 12.5 x 16	16 x 16 x 16	16 x 16 x 21	18 x 18 x 21	-	-	-
				18 x 18 x 16	-	-	-	-
3300	→	16 x 16 x 16	16 x 16 x 21	18 x 18 x 21	-	-	-	-
			18 x 18 x 16	-	-	-	-	-
4700	16 x 16 x 16	16 x 16 x 21	18 x 18 x 21	-	-	-	-	-
		18 x 18 x 16	-	-	-	-	-	-
6800	16 x 16 x 21	18 x 18 x 21	-	-	-	-	-	-
	18 x 18 x 16	-	-	-	-	-	-	-
10 000	18 x 18 x 21	-	-	-	-	-	-	-

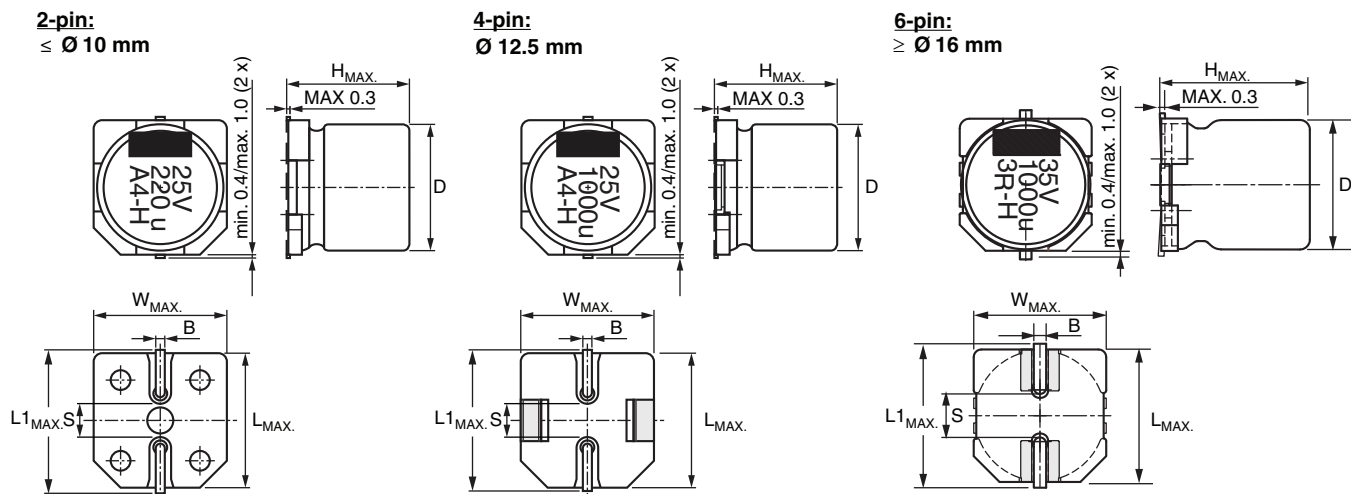

Fig. 2 - Dimensional outline



Table 1

DIMENSIONS in millimeters AND MASS									
NOMINAL CASE SIZE L x W x H	CASE CODE	L _{MAX.}	W _{MAX.}	H _{MAX.}	Ø D	B _{MAX.}	S	L1 _{MAX.}	MASS (g)
8 x 8 x 10	0810	8.5	8.5	10.5	8.0	1.0	2.2	10.2	≈ 1.0
10 x 10 x 10	1010	10.5	10.5	10.5	10.0	1.0	3.5	12.1	≈ 1.3
10 x 10 x 12	1012	10.5	10.5	12.5	10.0	1.0	3.5	12.1	≈ 1.5
10 x 10 x 14	1014	10.5	10.5	14.3	10.0	1.0	3.5	12.1	≈ 1.5
12.5 x 12.5 x 13	1213	12.9	12.9	14.0	12.5	1.3	3.6	14.9	≈ 2.6
12.5 x 12.5 x 16	1216	12.9	12.9	16.5	12.5	1.3	3.6	14.9	≈ 2.8
16 x 16 x 16	1616	16.6	16.6	17.5	16.0	1.3	6.5	18.6	≈ 5.5
16 x 16 x 21	1621	16.6	16.6	22.0	16.0	1.3	6.5	18.6	≈ 6.0
18 x 18 x 16	1816	19.0	19.0	17.5	18.0	1.3	6.5	21.0	≈ 8.0
18 x 18 x 21	1821	19.0	19.0	22.0	18.0	1.3	6.5	21.0	≈ 8.3

Table 2

TAPE AND REEL DIMENSIONS in millimeters, PACKAGING QUANTITIES						
NOMINAL CASE SIZE L x W x H	CASE CODE	PITCH P ₁	TAPE WIDTH W	TAPE THICKNESS T ₂	REEL DIAMETER	PACKAGING QUANTITY PER REEL
8 x 8 x 10	0810	16	24	11.6	380	500
10 x 10 x 10	1010	16	24	11.6	380	500
10 x 10 x 12	1012	16	24	12.8	330	250
10 x 10 x 14	1014	16	24	15.4	330	250
12.5 x 12.5 x 13	1213	20	24	16.2	380	250
12.5 x 12.5 x 16	1216	24	32	18.5	380	200
16 x 16 x 16	1616	28	44	18.9	380	150
16 x 16 x 21	1621	28	44	23.4	380	100
18 x 18 x 16	1816	32	44	18.9	380	125
18 x 18 x 21	1821	32	44	23.4	380	100

Note

- Detailed tape dimensions see section "PACKAGING".

MOUNTING

The capacitors are designed for automatic placement on to printed-circuit boards.

Optimum dimensions of soldering pads depend amongst others on soldering method, mounting accuracy, print layout and/or adjacent components. For recommended soldering pad dimensions, refer to Fig. 3 and Table 3.

SOLDERING

Soldering conditions are defined by the curve, temperature versus time, where the temperature is that measured on the component during processing.

For maximum conditions refer to Fig. 4 or Fig. 5.

Any temperature versus time curve which does not exceed the specified maximum curves may be applied.

As a general principle, temperature and duration shall be the **minimum** necessary required to ensure good soldering connections. However, the specified maximum curves should never be exceeded.

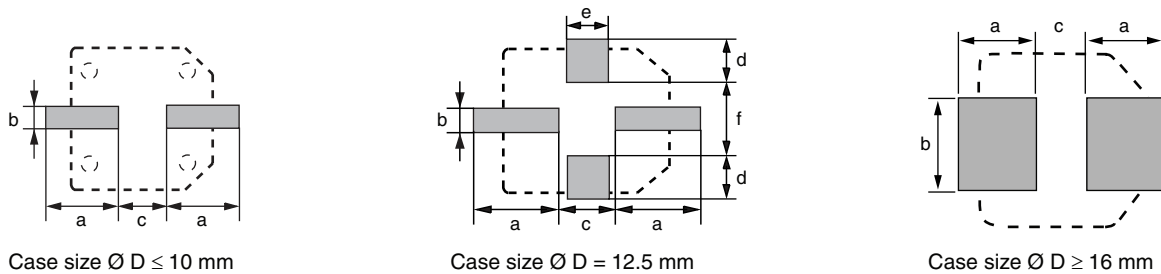

Fig. 3 - Recommended soldering pad dimensions

Table 3

RECOMMENDED SOLDERING PAD DIMENSIONS in millimeters						
CASE CODE	a	b	c	d	e	f
0810	4.4	2.5	3.0	-	-	-
1010	4.4	2.5	4.0	-	-	-
1012	4.4	2.5	4.0	-	-	-
1014	4.4	2.5	4.0	-	-	-
1213	6.3	2.5	4.0	4.2	5.0	5.6
1216	6.3	2.5	4.0	4.2	5.0	5.6
1616	7.8	9.6	4.7	-	-	-
1621	7.8	9.6	4.7	-	-	-
1816	8.8	9.6	4.7	-	-	-
1821	8.8	9.6	4.7	-	-	-

STANDARD SOLDERING PROFILE FOR LEAD (Pb)-FREE REFLOW PROCESS

Fig. 4 - Maximum temperature load during reflow soldering

Table 4

REFLOW SOLDERING CONDITIONS for MAL215097xxxE3		
PROFILE FEATURES	CASE CODE 0810 TO 1014	CASE CODE 1213 TO 1216
Max. time from 25 °C to T_{peak}	240 s	200 s
Max. ramp-up rate to 150 °C	3 K/s	3 K/s
Max. time from 150 °C to 200 °C (t_1)	150 s	120 s
Ramp up rate from 200 °C to T_{peak}	0.5 K/s to 3 K/s	0.5 K/s to 3 K/s
Max. time from 200 °C to 217 °C (t_2)	60 s	60 s
Max. time above $T_{Liquidus}$ (217 °C) (t_3)	90 s	60 s
Max. time above 230 °C (t_4)	40 s	30 s
Peak temperature T_{peak}	250 °C	240 °C
Max. time above T_{peak} minus 5 °C	5 s	10 s
Max. ramp-down rate from $T_{Liquidus}$	3 K/s to 6 K/s	3 K/s to 6 K/s

Notes

- Temperature measuring point on top of the case and on terminals.
- Max. 2 runs with pause of min. 30 min in between.

**ADVANCED SOLDERING PROFILE FOR LEAD (Pb)-FREE REFLOW PROCESS
ACCORDING TO JEDEC J-STD-020**

Fig. 5 - Maximum temperature load during reflow soldering

Table 5

REFLOW SOLDERING CONDITIONS for MAL215099xxxE3			
PROFILE FEATURES	CASE CODE 1010 TO 1012	CASE CODE 1213 TO 1216	CASE CODE 1616 TO 1821
Max. time from 25 °C to T_{Peak}	300 s	300 s	300 s
Max. ramp-up rate to 150 °C	3 K/s	3 K/s	3 K/s
Max. time from 150 °C to 200 °C (t_1)	150 s	150 s	150 s
Max. time from 190 °C to 200 °C (t_2)	110 s	110 s	110 s
Ramp up rate from 200 °C to T_{Peak}	0.5 K/s to 3 K/s	0.5 K/s to 3 K/s	0.5 K/s to 3 K/s
Max. time above $T_{Liquidus}$ (217 °C) (t_3)	90 s	90 s	90 s
Max. time above 230 °C (t_4)	70 s	65 s	60 s
Peak temperature T_{Peak}	260 °C	250 °C	245 °C
Max. time above T_{Peak} minus 5 °C	40 s	30 s	30 s
Ramp-down rate from $T_{Liquidus}$	3 K/s to 6 K/s	3 K/s to 6 K/s	3 K/s to 6 K/s

Notes

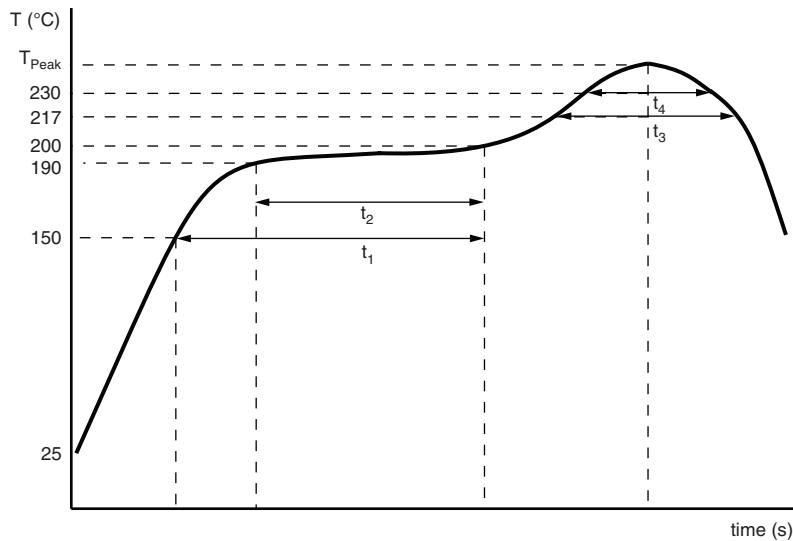
- Temperature measuring point on top of the case and on terminals.
- Max. 2 runs with pause of min. 30 min in between.



ELECTRICAL DATA	
SYMBOL	DESCRIPTION
C_R	Rated capacitance at 100 Hz, tolerance $\pm 20\%$
I_R	Rated RMS ripple current at 100 kHz, 105 °C
I_{L2}	Max. leakage current after 2 min at U_R
$\tan \delta$	Max. dissipation factor at 100 Hz
Z	Max. impedance at 100 kHz

Note

- Unless otherwise specified, all electrical values in Table 6 apply at $T_{amb} = 20\text{ °C}$, $P = 86\text{ kPa}$ to 106 kPa , $RH = 45\%$ to 75%

ORDERING EXAMPLE

Electrolytic capacitor 150 CRZ series

470 $\mu\text{F}/35\text{ V}$; $\pm 20\%$

Nominal case size: 12.5 mm x 12.5 mm x 13 mm; taped on reel

Ordering code: MAL215099012E3

Table 6

ELECTRICAL DATA AND ORDERING INFORMATION									
U_R (V)	C_R (μF)	NOMINAL CASE SIZE L x W x H (mm)	I_R 105 °C 100 kHz (mA)	I_L 2 min (μA)	$\tan \delta$ 100 Hz	Z 100 kHz 20 °C (Ω)	Z 100 kHz -40 °C (Ω)	ORDERING CODE ⁽¹⁾ MAL2150...	ORDERING CODE ⁽²⁾ MAL2150...
6.3	470	8 x 8 x 10	435	30	0.24	0.250	2.00	97311E3	-
	1000	10 x 10 x 10	670	63	0.24	0.130	1.10	97301E3	99301E3
	2200	12.5 x 12.5 x 13	905	139	0.26	0.077	0.60	97312E3	99312E3
	4700	16 x 16 x 16	1350	296	0.28	0.050	0.40	-	99313E3
	6800	16 x 16 x 21	1666	428	0.30	0.035	0.28	-	99314E3
	6800	18 x 18 x 16	1400	428	0.32	0.050	0.40	-	99315E3
	10 000	18 x 18 x 21	1756	630	0.34	0.035	0.28	-	99316E3
10	330	8 x 8 x 10	435	33	0.20	0.250	2.00	97411E3	-
	470	8 x 8 x 10	435	47	0.20	0.250	2.00	97412E3	-
	680	10 x 10 x 10	670	68	0.20	0.130	1.10	97401E3	99401E3
	1000	10 x 10 x 12	850	100	0.20	0.100	0.80	-	99403E3
	1000	10 x 10 x 14	850	100	0.20	0.100	0.80	97402E3	-
	1500	12.5 x 12.5 x 13	905	150	0.22	0.077	0.60	97413E3	99413E3
	2200	12.5 x 12.5 x 16	1007	220	0.22	0.060	0.48	97414E3	99414E3
	3300	16 x 16 x 16	1350	330	0.24	0.050	0.40	-	99415E3
	4700	16 x 16 x 21	1666	470	0.26	0.035	0.28	-	99416E3
	4700	18 x 18 x 16	1400	470	0.26	0.050	0.40	-	99417E3
6800	18 x 18 x 21	1756	680	0.28	0.035	0.28	-	99418E3	
16	220	8 x 8 x 10	435	35	0.16	0.250	2.00	97511E3	-
	330	8 x 8 x 10	435	53	0.16	0.250	2.00	97512E3	-
	470	10 x 10 x 10	670	75	0.16	0.130	1.10	97501E3	99501E3
	680	10 x 10 x 12	850	109	0.16	0.100	0.80	-	99503E3
	680	10 x 10 x 14	850	109	0.16	0.100	0.80	97502E3	-
	1000	12.5 x 12.5 x 13	905	160	0.18	0.077	0.60	97513E3	99513E3
	1500	12.5 x 12.5 x 16	1007	240	0.18	0.060	0.48	97514E3	99514E3
	2200	16 x 16 x 16	1350	352	0.20	0.050	0.40	-	99515E3
	3300	16 x 16 x 21	1666	528	0.22	0.035	0.28	-	99516E3
	3300	18 x 18 x 16	1400	528	0.22	0.050	0.40	-	99517E3
	4700	18 x 18 x 21	1756	752	0.26	0.035	0.28	-	99518E3
25	150	8 x 8 x 10	420	38	0.14	0.280	2.24	97611E3	-
	220	8 x 8 x 10	420	55	0.14	0.280	2.24	97612E3	-
	330	10 x 10 x 10	640	83	0.14	0.140	1.12	97601E3	99601E3
	470	10 x 10 x 12	820	118	0.14	0.110	0.88	-	99603E3
	470	10 x 10 x 14	820	118	0.14	0.110	0.88	97602E3	-
	680	12.5 x 12.5 x 13	905	170	0.16	0.077	0.60	97613E3	99613E3
	1000	12.5 x 12.5 x 16	1007	250	0.16	0.060	0.48	97614E3	99614E3
	1500	16 x 16 x 16	1350	375	0.16	0.050	0.40	-	99615E3
	2200	16 x 16 x 21	1666	550	0.18	0.035	0.28	-	99616E3
	2200	18 x 18 x 16	1400	550	0.18	0.050	0.40	-	99617E3
	3300	18 x 18 x 21	1756	825	0.20	0.035	0.28	-	99618E3

Notes

- ⁽¹⁾ Standard reflow soldering profile, see Fig. 4 and Table 4
- ⁽²⁾ Advanced reflow soldering profile, according to JEDEC J-STD-020, see Fig. 5 and Table 5



ELECTRICAL DATA AND ORDERING INFORMATION									
U _R (V)	C _R (μF)	NOMINAL CASE SIZE L x W x H (mm)	I _R 105 °C 100 kHz (mA)	I _L 2 min (μA)	tan δ 100 Hz	Z 100 kHz 20 °C (Ω)	Z 100 kHz -40 °C (Ω)	ORDERING CODE ⁽¹⁾ MAL2150...	ORDERING CODE ⁽²⁾ MAL2150...
35	100	8 x 8 x 10	405	35	0.12	0.300	2.40	97011E3	-
	220	10 x 10 x 10	630	77	0.12	0.150	1.20	97001E3	99001E3
	330	10 x 10 x 12	790	116	0.12	0.120	0.96	-	99003E3
	330	10 x 10 x 14	790	116	0.12	0.120	0.96	97002E3	-
	470	12.5 x 12.5 x 13	905	165	0.14	0.077	0.60	97012E3	99012E3
	680	12.5 x 12.5 x 16	1007	238	0.14	0.060	0.48	97013E3	99013E3
	1000	16 x 16 x 16	1350	350	0.14	0.050	0.40	-	99014E3
	1500	16 x 16 x 21	1666	525	0.14	0.035	0.28	-	99015E3
	1500	18 x 18 x 16	1400	525	0.14	0.050	0.40	-	99016E3
	2200	18 x 18 x 21	1756	770	0.16	0.035	0.28	-	99017E3
50	68	8 x 8 x 10	333	34	0.12	0.480	3.84	97111E3	-
	100	10 x 10 x 10	490	50	0.12	0.240	1.92	97101E3	99101E3
	220	10 x 10 x 12	620	110	0.12	0.190	1.52	-	99103E3
	220	10 x 10 x 14	620	110	0.12	0.190	1.52	97102E3	-
	330	12.5 x 12.5 x 13	690	165	0.12	0.130	1.04	97112E3	99112E3
	680	16 x 16 x 16	1035	340	0.12	0.085	0.68	-	99114E3
	1000	16 x 16 x 21	1100	500	0.12	0.080	0.64	-	99115E3
	1000	18 x 18 x 16	1074	500	0.12	0.085	0.68	-	99116E3
	1500	18 x 18 x 21	1470	750	0.12	0.080	0.64	-	99117E3
	63	33	8 x 8 x 10	270	21	0.10	0.650	5.20	97812E3
47		8 x 8 x 10	270	30	0.10	0.650	5.20	97811E3	-
47		10 x 10 x 10	390	30	0.10	0.380	3.00	97801E3	99801E3
68		10 x 10 x 10	390	43	0.10	0.380	3.00	97802E3	99802E3
100		10 x 10 x 12	507	63	0.10	0.290	2.32	-	99804E3
100		10 x 10 x 14	507	63	0.10	0.290	2.32	97803E3	-
150		12.5 x 12.5 x 13	507	97	0.10	0.250	2.00	97821E3	99821E3
220		12.5 x 12.5 x 16	637	141	0.10	0.200	1.60	97815E3	99815E3
330		16 x 16 x 16	910	208	0.10	0.150	1.20	-	99816E3
470		16 x 16 x 21	987	296	0.10	0.120	0.96	-	99817E3
470		18 x 18 x 16	944	296	0.10	0.150	1.20	-	99818E3
680		18 x 18 x 21	1160	428	0.10	0.120	0.96	-	99819E3
100	4.7	10 x 10 x 10	210	5	0.07	1.9	87	97901E3	-
	10	10 x 10 x 10	240	10	0.07	1.4	68	97902E3	-
	22	10 x 10 x 10	240	22	0.07	1.4	68	97903E3	-
	33	10 x 10 x 10	250	33	0.10	1.4	68	97904E3	-

Notes

- (1) Standard reflow soldering profile, see Fig. 4 and Table 4
- (2) Advanced reflow soldering profile, according to JEDEC J-STD-020, see Fig. 5 and Table 5

Table 7

ADDITIONAL ELECTRICAL DATA		
PARAMETER	CONDITIONS	VALUE
Voltage		
Surge voltage for short periods	IEC 60384-18, subclause 4.14	$U_s \leq 1.15 \times U_R$
Reverse voltage for short periods	IEC 60384-18, subclause 4.16	$U_{rev} \leq 1 V$
Current		
Leakage current	After 2 min at U_R	$I_{L2} \leq 0.01 \times C_R \times U_R$
Inductance		
Equivalent series inductance (ESL)	$\varnothing D = 8 \text{ mm}$	Typ. 6 nH
	$\varnothing D = 10 \text{ mm}$	Typ. 8 nH
	$\varnothing D \geq 12.5 \text{ mm}$	Typ. 11 nH
Resistance		
Equivalent series resistance (ESR) at 100 Hz	Calculated from $\tan \delta_{max.}$ and C_R (see Table 6)	$ESR = \tan \delta / 2\pi f C_R$

CAPACITANCE

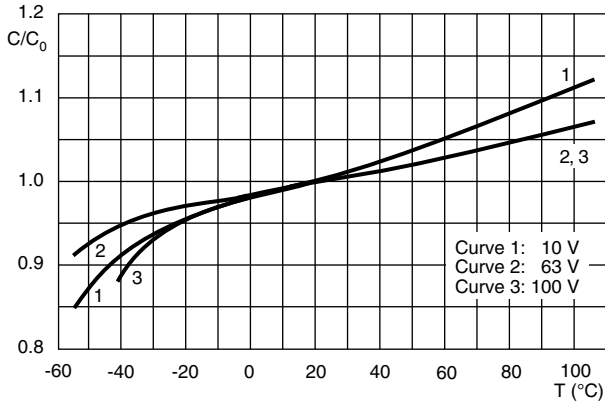

C_0 = Capacitance at 20 °C, 100 Hz

Fig. 6 - Typical multiplier of capacitance as a function of temperature at 100 Hz

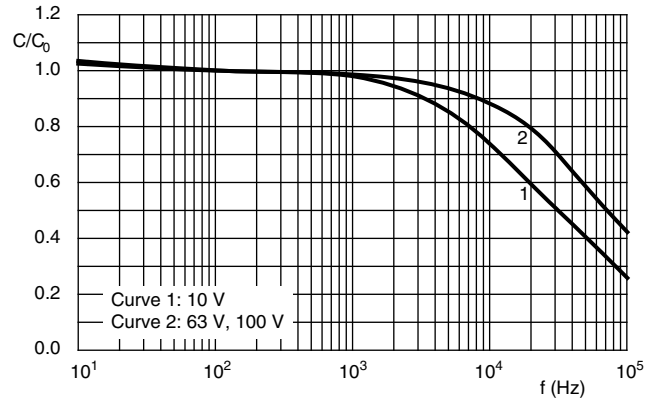

C_0 = Typical capacitance at 20 °C, 100 Hz

Fig. 7 - Typical multiplier of capacitance as a function of frequency at 20 °C

EQUIVALENT SERIES RESISTANCE (ESR)

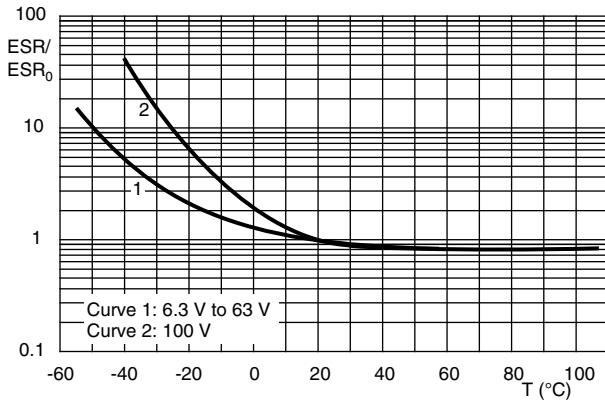

ESR_0 = Typical ESR at 20 °C, 100 Hz

Fig. 8 - Typical multiplier of ESR as a function of temperature at 100 Hz

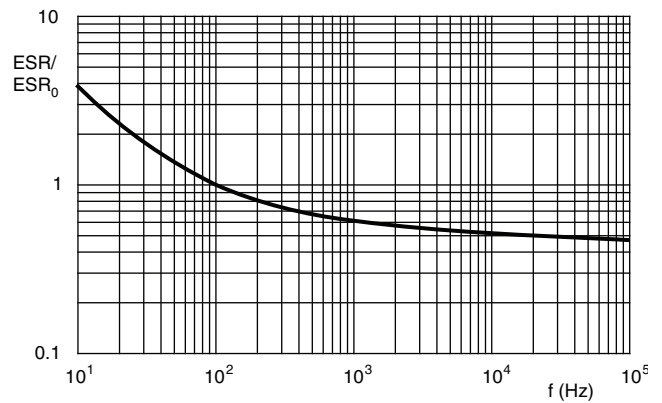

ESR_0 = Typical ESR at 20 °C, 100 Hz

Fig. 9 - Typical multiplier ESR as a function of frequency at 20 °C

DISSIPATION FACTOR (tan δ)

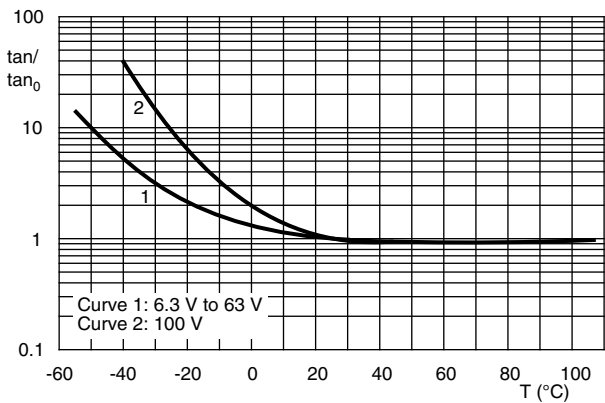

$\tan \delta_0$ = Typical $\tan \delta$ at 20 °C, 100 Hz

Fig. 10 - Typical multiplier of dissipation factor $\tan \delta$ as a function of temperature at 20 °C at 100 Hz

IMPEDANCE (Z)

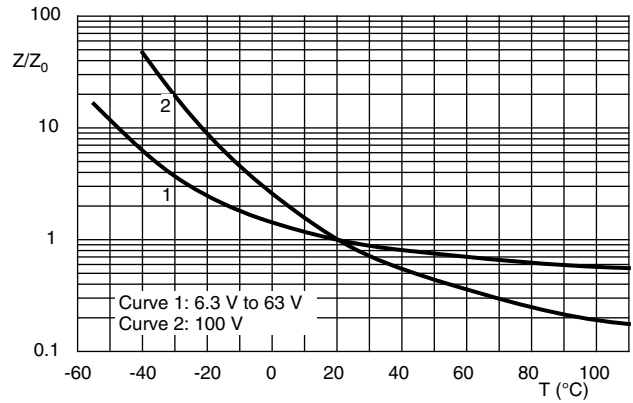

Z_0 = Typical impedance Z at 20 °C, 100 kHz

Fig. 11 - Typical multiplier of impedance Z as a function of temperature at 100 kHz

IMPEDANCE (Z)

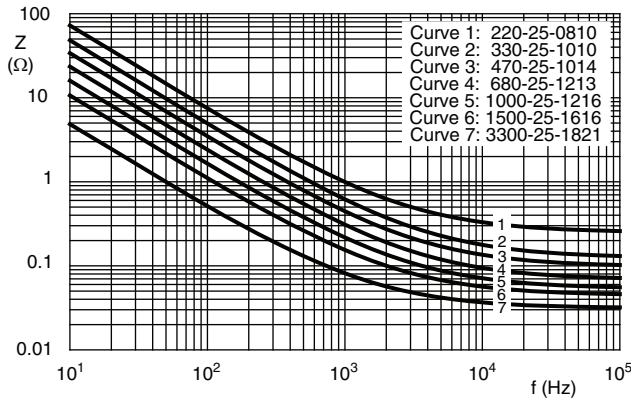

Fig. 12 - Typical impedance Z as a function of frequency at 20 °C

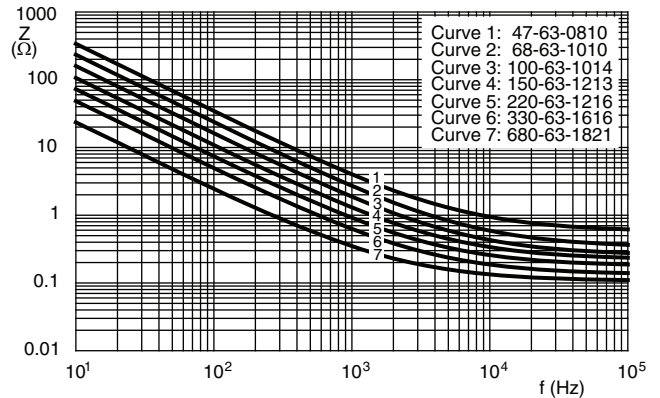

Fig. 13 - Typical impedance Z as a function of frequency at 20 °C

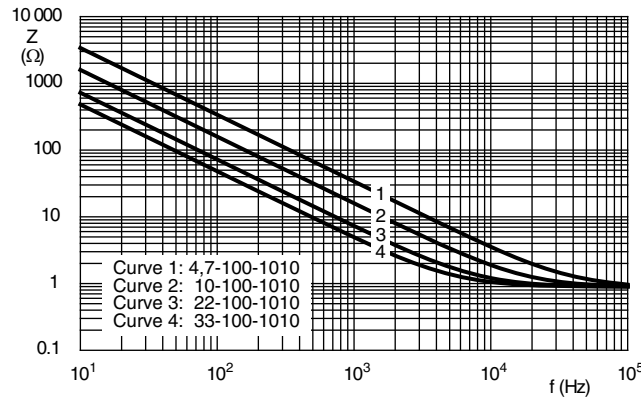

Fig. 14 - Typical impedance Z as a function of frequency at 20 °C

RIPPLE CURRENT AND USEFUL LIFE

Table 8

ENDURANCE TEST DURATION AND USEFUL LIFE							
NOMINAL CASE SIZE D x L (mm)	CASE CODE	MAL215097...			MAL215099...		
		ENDURANCE AT 105 °C (h)	USEFUL LIFE AT 105 °C (h)	USEFUL LIFE AT 40 °C 1.8 x I _R APPLIED (h)	ENDURANCE AT 105 °C (h)	USEFUL LIFE AT 105 °C (h)	USEFUL LIFE AT 40 °C 1.8 x I _R APPLIED (h)
8 x 8 x 10	0810	2000	2500	125 000	-	-	-
10 x 10 x 10	1010	2000	3000	150 000	2000	3000	150 000
10 x 10 x 12	1012	-	-	-	2000	3000	150 000
10 x 10 x 14	1014	2000	3000	150 000	-	-	-
12.5 x 12.5 x 13	1213	3000	5000	250 000	5000	6000	300 000
12.5 x 12.5 x 16	1216	3000	5000	250 000	6500	7500	375 000
16 x 16 x 16	1616	-	-	-	8000	10 000	500 000
16 x 16 x 21	1621	-	-	-	8000	10 000	500 000
18 x 18 x 16	1816	-	-	-	8000	10 000	500 000
18 x 18 x 21	1821	-	-	-	8000	10 000	500 000

RIPPLE CURRENT AND USEFUL LIFE

MEA240

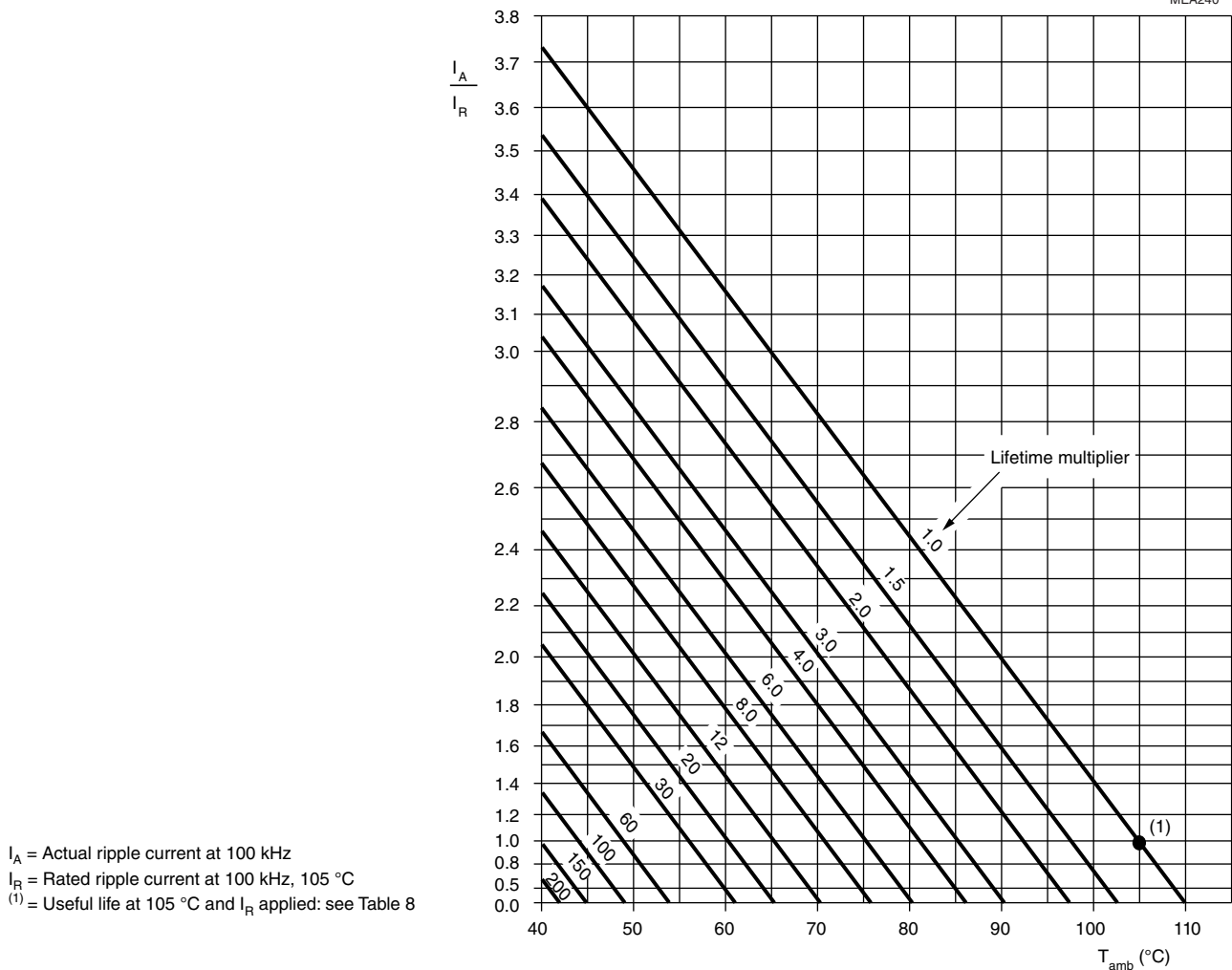

Fig. 15 - Multiplier of useful life as a function of ambient temperature and ripple current load

Table 9

MULTIPLIER OF RIPPLE CURRENT (I_R) AS A FUNCTION OF FREQUENCY			
FREQUENCY (Hz)	I_R MULTIPLIER		
	$U_R = 6.3 \text{ V TO } 25 \text{ V}$	$U_R = 35 \text{ V}$	$U_R = 50 \text{ V TO } 100 \text{ V}$
100	0.70	0.65	0.60
300	0.80	0.80	0.75
1000	0.85	0.85	0.85
3000	0.93	0.93	0.93
10 000	0.95	0.95	0.95
30 000	0.97	0.97	0.97
100 000	1.00	1.00	1.00



Table 10

TEST PROCEDURES AND REQUIREMENTS			
TEST		PROCEDURE (quick reference)	REQUIREMENTS
NAME OF TEST	REFERENCE		
Mounting	IEC 60384-18, subclause 4.3	Shall be performed prior to tests mentioned below; reflow soldering; for maximum temperature load refer to chapter "Mounting"	$\Delta C/C: \pm 5 \%$ $\tan \delta \leq \text{spec. limit}$ $I_{L2} \leq \text{spec. limit}$
Endurance	IEC 60384-18/CECC32300, subclause 4.15	$T_{amb} = 105 \text{ }^\circ\text{C}$; U_R applied; for test duration see Table 8	$U_R = 6.3 \text{ V}$; $\Delta C/C: \pm 25 \%$ $U_R \geq 10 \text{ V}$; $\Delta C/C: \pm 20 \%$ $\tan \delta \leq 2 \times \text{spec. limit}$ $I_{L2} \leq \text{spec. limit}$
Useful life	CECC 30301, subclause 1.8.1	$T_{amb} = 105 \text{ }^\circ\text{C}$; U_R and I_R applied; for test duration see Table 8	$\Delta C/C: \pm 30 \%$ $\tan \delta \leq 3 \times \text{spec. limit}$ $I_{L2} \leq \text{spec. limit}$ no short or open circuit total failure percentage: $\leq 1 \%$
Shelf life (storage at high temperature)	IEC 60384-18/ CECC32300, subclause 4.17	$T_{amb} = 105 \text{ }^\circ\text{C}$; no voltage applied; 1000 h after test: U_R to be applied for 30 min, 24 h to 48 h before measurement	For requirements see "Endurance test" above



Disclaimer

ALL PRODUCT, PRODUCT SPECIFICATIONS AND DATA ARE SUBJECT TO CHANGE WITHOUT NOTICE TO IMPROVE RELIABILITY, FUNCTION OR DESIGN OR OTHERWISE.

Vishay Intertechnology, Inc., its affiliates, agents, and employees, and all persons acting on its or their behalf (collectively, "Vishay"), disclaim any and all liability for any errors, inaccuracies or incompleteness contained in any datasheet or in any other disclosure relating to any product.

Vishay makes no warranty, representation or guarantee regarding the suitability of the products for any particular purpose or the continuing production of any product. To the maximum extent permitted by applicable law, Vishay disclaims (i) any and all liability arising out of the application or use of any product, (ii) any and all liability, including without limitation special, consequential or incidental damages, and (iii) any and all implied warranties, including warranties of fitness for particular purpose, non-infringement and merchantability.

Statements regarding the suitability of products for certain types of applications are based on Vishay's knowledge of typical requirements that are often placed on Vishay products in generic applications. Such statements are not binding statements about the suitability of products for a particular application. It is the customer's responsibility to validate that a particular product with the properties described in the product specification is suitable for use in a particular application. Parameters provided in datasheets and/or specifications may vary in different applications and performance may vary over time. All operating parameters, including typical parameters, must be validated for each customer application by the customer's technical experts. Product specifications do not expand or otherwise modify Vishay's terms and conditions of purchase, including but not limited to the warranty expressed therein.

Except as expressly indicated in writing, Vishay products are not designed for use in medical, life-saving, or life-sustaining applications or for any other application in which the failure of the Vishay product could result in personal injury or death. Customers using or selling Vishay products not expressly indicated for use in such applications do so at their own risk. Please contact authorized Vishay personnel to obtain written terms and conditions regarding products designed for such applications.

No license, express or implied, by estoppel or otherwise, to any intellectual property rights is granted by this document or by any conduct of Vishay. Product names and markings noted herein may be trademarks of their respective owners.

Material Category Policy

Vishay Intertechnology, Inc. hereby certifies that all its products that are identified as RoHS-Compliant fulfill the definitions and restrictions defined under Directive 2011/65/EU of The European Parliament and of the Council of June 8, 2011 on the restriction of the use of certain hazardous substances in electrical and electronic equipment (EEE) - recast, unless otherwise specified as non-compliant.

Please note that some Vishay documentation may still make reference to RoHS Directive 2002/95/EC. We confirm that all the products identified as being compliant to Directive 2002/95/EC conform to Directive 2011/65/EU.

Vishay Intertechnology, Inc. hereby certifies that all its products that are identified as Halogen-Free follow Halogen-Free requirements as per JEDEC JS709A standards. Please note that some Vishay documentation may still make reference to the IEC 61249-2-21 definition. We confirm that all the products identified as being compliant to IEC 61249-2-21 conform to JEDEC JS709A standards.