

# AFBR-57D9AMZ

Digital Diagnostic SFP, 850 nm, 8.5/4.25/2.125 GBd

Low Voltage (3.3 V) Fibre Channel

RoHS Compliant Optical Transceiver



## Data Sheet



### Description

Avago Technologies' AFBR-57D9AMZ optical transceiver supports high-speed serial links over multimode optical fiber at signaling rates up to 8.5 GBd. Compliant with Small Form Pluggable (SFP) Multi Source Agreement (MSA) mechanical and electrical specifications for LC Duplex transceivers, ANSI Fibre Channel for FC-PI-4 and FC-PI-2 for gigabit applications. The part is electrically interoperable with SFP conformant devices.

The AFBR-57D9AMZ is a multi-rate 850nm SFP which ensures compliance to 8.5/4.25/2.125 GBd Fibre Channel specifications without the need for Rate Select. The AFBR-57D9AMZ will ignore both Rate Select pin and control bit inputs (ie. no connect inside the SFP). This simplifies Fibre Channel host auto-negotiation algorithms, layout and software.

### Related Products

- AFBR-59R5LZ: 850 nm + 3.3 V LC SFF 2x7 for 4.25/2.125/1.0625 GBd Fibre Channel
- AFBR-57R5APZ: 850 nm + 3.3 V LC SFP for 4.25/2.125/1.0625 GBd Fibre Channel
- AFCT-57D5APZ: 1310nm FP + 3.3v LC SFP for 8.5/4.25/2.125 GBd Fibre Channel
- AFCT-57D5ATPZ: 1310nm DFB + 3.3v LC SFP for 8.5/4.25/2.125 GBd Fibre Channel

### Features

- Compliant to Restriction on Hazardous Substances (RoHS) directive
- Rate Select not required
- Diagnostic features per SFF-8472 "Diagnostic Monitoring Interface for Optical Transceivers"
- Real time monitoring of:
  - Transmitted optical power
  - Received optical power
  - Laser bias current
  - Temperature
  - Supply voltage
- SFP Plus Mechanical Applications
- Wide temperature and supply voltage operation (-10°C to 85°C) (3.3 V ± 10%)
- Transceiver specifications per SFP (SFF-8074i) Multi-Source Agreement and SFF-8472 (revision 10.3)
  - 8.5 GBd Fibre Channel operation for FC-PI-4 800-M5-SN-S, 800-M6-SN-S and 800-M5E-SN-I
  - 4.25 GBd Fibre Channel operation for FC-PI 400-M5-SN-I, 400-M6-SN-I and 400 M5E-SN-I
  - 2.125 GBd Fibre Channel operation for FC-PI 200-M5-SN-I, 200-M6-SN-I and 200 M5E-SN-I
- Link lengths at 8.5 GBd: 21m with 62.5um OM1, 50m with 50um OM2, 150m with 50um OM3, 190m with 50um OM4
- Link lengths at 4.25 GBd: 70m with 62.5um OM1, 150m with 50um OM2, 380m with 50um OM3, 400m with 50um OM4
- Link lengths at 2.125 GBd: 150m with 62.5um OM1, 300m with 50um OM2, 500m with 50um OM3
- LC Duplex optical connector interface conforming to ANSI TIA/EIA604-10 (FOCIS 10A)
- 850 nm Vertical Cavity Surface Emitting Laser (VCSEL) source technology
- IEC 60825-1 Class 1/CDRH Class 1 laser eye safe
- Enhanced EMI performance for high port density applications

## **Description, continued**

As an enhancement to the conventional SFP interface defined in SFF-8074i, the AFBR-57D9AMZ is compliant to SFF-8472 (digital diagnostic interface for optical transceivers). Using the 2-wire serial interface defined in the SFF-8472 MSA, the AFBR-57D9AMZ provides real time temperature, supply voltage, laser bias current, laser average output power and received input power. This information is in addition to conventional SFP base data. The digital diagnostic interface also adds the ability to disable the transmitter (TX\_DISABLE), monitor for Transmitter Faults (TX\_FAULT), and monitor for Receiver Loss of Signal (RX\_LOS).

## **Installation**

The AFBR-57D9AMZ can be installed in any SFF-8074i compliant Small Form Pluggable (SFP) port regardless of host equipment operating status. The AFBR-57D9AMZ is hot-pluggable, allowing the module to be installed while the host system is operating and on-line. Upon insertion, the transceiver housing makes initial contact with the host board SFP cage, mitigating potential damage due to Electro-Static Discharge (ESD).

## **Digital Diagnostic Interface and Serial Identification**

The 2-wire serial interface is based on ATMEL AT24C01A series EEPROM protocol and signaling detail. Conventional EEPROM memory, bytes 0-255 at memory address 0xA0, is organized in compliance with SFF-8074i. New digital diagnostic information, bytes 0-255 at memory address 0xA2, is compliant to SFF-8472. The new diagnostic information provides the opportunity for Predictive Failure Identification, Compliance Prediction, Fault Isolation and Component Monitoring.

## **Predictive Failure Identification**

The AFBR-57D9AMZ predictive failure feature allows a host to identify potential link problems before system performance is impacted. Prior identification of link problems enables a host to service an application via “fail over” to a redundant link or replace a suspect device, maintaining system uptime in the process. For applications where ultra-high system uptime is required, a digital SFP provides a means to monitor two real-time laser metrics associated with observing laser degradation and predicting failure: average laser bias current (Tx\_Bias) and average laser optical power (Tx\_Power).

## **Compliance Prediction**

Compliance prediction is the ability to determine if an optical transceiver is operating within its operating and environmental requirements. AFBR-57D9AMZ devices provide real-time access to transceiver internal supply voltage and temperature, allowing a host to identify potential component compliance issues. Received optical power is also available to assess compliance of a cable plant and remote transmitter. When operating out of requirements, the link cannot guarantee error free transmission.

## **Fault Isolation**

The fault isolation feature allows a host to quickly pinpoint the location of a link failure, minimizing downtime. For optical links, the ability to identify a fault at a local device, remote device or cable plant is crucial to speeding service of an installation. AFBR-57D9AMZ real-time monitors of Tx\_Bias, Tx\_Power, Vcc, Temperature and Rx\_Power can be used to assess local transceiver current operating conditions. In addition, status flags Tx\_Disable and Rx Loss of Signal (LOS) are mirrored in memory and available via the two-wire serial interface.

## **Component Monitoring**

Component evaluation is a more casual use of the AFBR-57D9AMZ real-time monitors of Tx\_Bias, Tx\_Power, Vcc, Temperature and Rx\_Power. Potential uses are as debugging aids for system installation and design, and transceiver parametric evaluation for factory or field qualification. For example, temperature per module can be observed in high density applications to facilitate thermal evaluation of blades, PCI cards and systems.

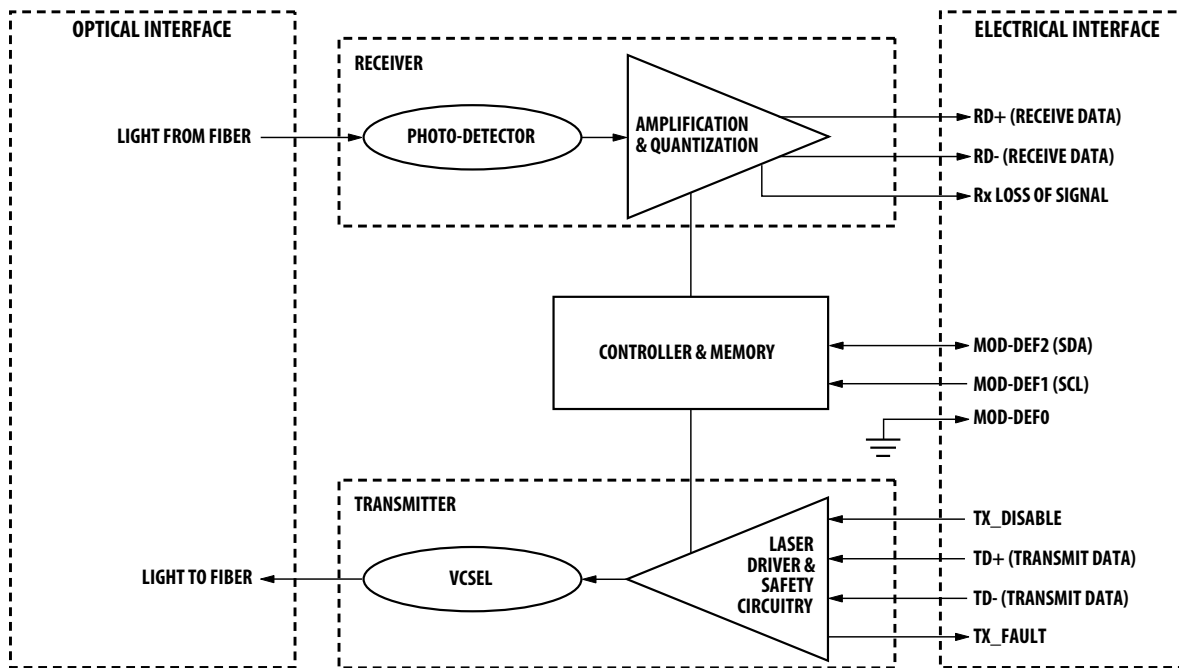

Figure 1. Transceiver functional diagram.

### Transmitter Section

The transmitter section includes the Transmitter Optical SubAssembly (TOSA) and laser driver circuitry. The TOSA, containing an 850 nm VCSEL (Vertical Cavity Surface Emitting Laser) light source, is located at the optical interface and mates with the LC optical connector. The TOSA is driven by a custom IC which uses the incoming differential high speed logic signal to modulate the laser diode driver current. This Tx laser driver circuit regulates the optical power at a constant level provided the incoming data pattern is dc balanced (8B/10B code, for example).

### Transmit Disable (Tx\_Disable)

The AFBR-57D9AMZ accepts a TTL and CMOS compatible transmit disable control signal input (pin 3) which shuts down the transmitter optical output. A high signal implements this function while a low signal allows normal transceiver operation. In the event of a fault (e.g. eye safety circuit activated), cycling this control signal resets the module as depicted in Figure 4. An internal pull up resistor disables the transceiver transmitter until the host pulls the input low. Host systems should allow a 10 ms interval between successive assertions of this control signal. Tx\_Disable can also be asserted via the two-wire serial interface (address A2h, byte 110, bit 6) and monitored (address A2h, byte 110, bit 7).

The contents of A2h, byte 110, bit 6 are logic OR'd with hardware Tx\_Disable (pin 3) to control transmitter operation.

### Transmit Fault (Tx\_Fault)

A catastrophic laser fault will activate the transmitter signal, TX\_FAULT, and disable the laser. This signal is an open collector output (pull-up required on the host board). A low signal indicates normal laser operation and a high signal indicates a fault. The TX\_FAULT will be latched high when a laser fault occurs and is cleared by toggling the TX\_DISABLE input or power cycling the transceiver. The transmitter fault condition can also be monitored via the two-wire serial interface (address A2, byte 110, bit 2).

### Eye Safety Circuit

The AFBR-57D9AMZ provides Class 1 (single fault tolerant) eye safety by design and has been tested for compliance with the requirements listed in Table 1. The eye safety circuit continuously monitors the optical output power level and will disable the transmitter upon detecting an unsafe condition beyond the scope of Class 1 certification. Such unsafe conditions can be due to inputs from the host board (Vcc fluctuation, unbalanced code) or a fault within the transceiver.

## Receiver Section

The receiver section includes the Receiver Optical SubAssembly (ROSA) and the amplification/quantization circuitry. The ROSA, containing a PIN photodiode and custom transimpedance amplifier, is located at the optical interface and mates with the LC optical connector. The ROSA output is fed to a custom IC that provides post-amplification and quantization.

## Receiver Loss of Signal (Rx\_LOS)

The post-amplification IC also includes transition detection circuitry which monitors the ac level of incoming optical signals and provides a TTL/CMOS compatible status signal to the host (pin 8). An adequate optical input results in a low Rx\_LOS output while a high Rx\_LOS output indicates an unusable optical input. The Rx\_LOS thresholds are factory set so that a high output indicates a definite optical fault has occurred. Rx\_LOS can also be monitored via the two-wire serial interface (address A2h, byte 110, bit 1).

## Functional Data I/O

The AFBR-57D9AMZ interfaces with the host circuit board through twenty I/O pins (SFP electrical connector) identified by function in Table 2. The board layout for this interface is depicted in Figure 6.

The AFBR-57D9AMZ high speed transmit and receive interfaces require SFP MSA compliant signal lines on the host board. To simplify board requirements, biasing resistors and ac coupling capacitors are incorporated into the SFP transceiver module (per SFF-8074i) and hence are not required on the host board. The Tx\_Disable, Tx\_Fault, and Rx\_LOS lines require TTL lines on the host board (per SFF-8074i) if used. If an application chooses not to take advantage of the functionality of these pins, care must be taken to ground Tx\_Disable (for normal operation).

Figure 2 depicts the recommended interface circuit to link the AFBR-57D9AMZ to supporting physical layer ICs. Timing for MSA compliant control signals implemented in the transceiver are listed in Figure 4.

## Application Support

An Evaluation Kit and Reference Designs are available to assist in evaluation of the AFBR-57D9AMZ. Please contact your local Field Sales representative for availability and ordering details.

## Caution

There are no user serviceable parts nor maintenance requirements for the AFBR-57D9AMZ. All mechanical adjustments are made at the factory prior to shipment. Tampering with, modifying, misusing or improperly handling the AFBR-57D9AMZ will void the product warranty. It may also result in improper operation and possibly overstress the laser source. Performance degradation or device failure may result. Connection of the AFBR-57D9AMZ to a light source not compliant with ANSI FC-PI specifications, operating above maximum operating conditions or in a manner inconsistent with its design and function may result in exposure to hazardous light radiation and may constitute an act of modifying or manufacturing a laser product. Persons performing such an act are required by law to re-certify and re-identify the laser product under the provisions of U.S. 21 CFR (Subchapter J) and TUV.

## Ordering Information

Please contact your local field sales engineer or one of Avago Technologies franchised distributors for ordering information. For technical information, please visit Avago Technologies' WEB page at [www.avagotech.com](http://www.avagotech.com) or contact Avago Technologies Semiconductor Products Customer Response Center at 1-800-235-0312. For information related to SFF Committee documentation visit [www.sffcommittee.org](http://www.sffcommittee.org).

## Regulatory Compliance

The AFBR-57D9AMZ complies with all applicable laws and regulations as detailed in Table 1. Certification level is dependent on the overall configuration of the host equipment. The transceiver performance is offered as a figure of merit to assist the designer.

## Electrostatic Discharge (ESD)

The AFBR-57D9AMZ is compatible with ESD levels found in typical manufacturing and operating environments as described in Table 1. In the normal handling and operation of optical transceivers, ESD is of concern in two circumstances.

The first case is during handling of the transceiver prior to insertion into an SFP compliant cage. To protect the device, it's important to use normal ESD handling pre-cautions. These include use of grounded wrist straps, work-benches and floor wherever a transceiver is handled.

The second case to consider is static discharges to the exterior of the host equipment chassis after installation. If the optical interface is exposed to the exterior of host equipment cabinet, the transceiver may be subject to system level ESD requirements.

## Electromagnetic Interference (EMI)

Equipment incorporating gigabit transceivers is typically subject to regulation by the FCC in the United States, CENELEC EN55022 (CISPR 22) in Europe and VCCI in Japan. The AFBR-57D9AMZ's compliance to these standards is detailed in Table 1. The metal housing and shielded design of the AFBR-57D9AMZ minimizes the EMI challenge facing the equipment designer.



## EMI Immunity (Susceptibility)

Due to its shielded design, the EMI immunity of the AFBR-57D9AMZ exceeds typical industry standards.

## Flammability

The AFBR-57D9AMZ optical transceiver is made of metal and high strength, heat resistant, chemical resistant and UL 94V-0 flame retardant plastic.

**Table 1. Regulatory Compliance**

Feature	Test Method	Performance
Electrostatic Discharge (ESD) to the Electrical Pins	MIL-STD-883C Method 3015.4	Class 1 (> 2000 Volts)
Electrostatic Discharge (ESD) to the Duplex LC Receptacle	IEC 61000-4-2	Typically, no damage occurs with 25 kV when the duplex LC connector receptacle is contacted by a Human Body Model probe.
	IEC 61000-4-2	10 contacts of 8 kV on the electrical faceplate with device inserted into a panel.
Electrostatic Discharge (ESD) to the Optical Connector	IEC 61000-4-2	Air discharge of 15 kV (min.) contact to connector without damage.
Electromagnetic Interference (EMI)	FCC Class B CENELEC EN55022 Class B (CISPR 22A) VCCI Class A	System margins are dependent on customer board and chassis design.
Immunity	IEC 61000-4-3	Typically shows no measurable effect from a 10 V/m field swept from 10 MHz to 1 GHz.
Laser Eye Safety and Equipment Type Testing	US FDA CDRH AEL Class 1 US21 CFR, Subchapter J per Paragraphs 1002.10 and 1002.12  (IEC) EN 60825-1: 2007 (IEC) EN 60825-2: 2004+A1 (IEC) EN 60950-1: 2006+A11	CDRH Certification No.: 9720151-128 TUV file: R 72121699
  		
Component Recognition	Underwriters Laboratories and Canadian Standards Association Joint Component Recognition for Information Technology Equipment including Electrical Business Equipment	UL file: E173874, Vol. 1
RoHS Compliance	RoHS Directive 2002/95/EC and it's amendment directives 6/6	SGS Test Report No. LPC/13392 (AD-1)/07 CTS Ref. CTS/07/3283/Avago

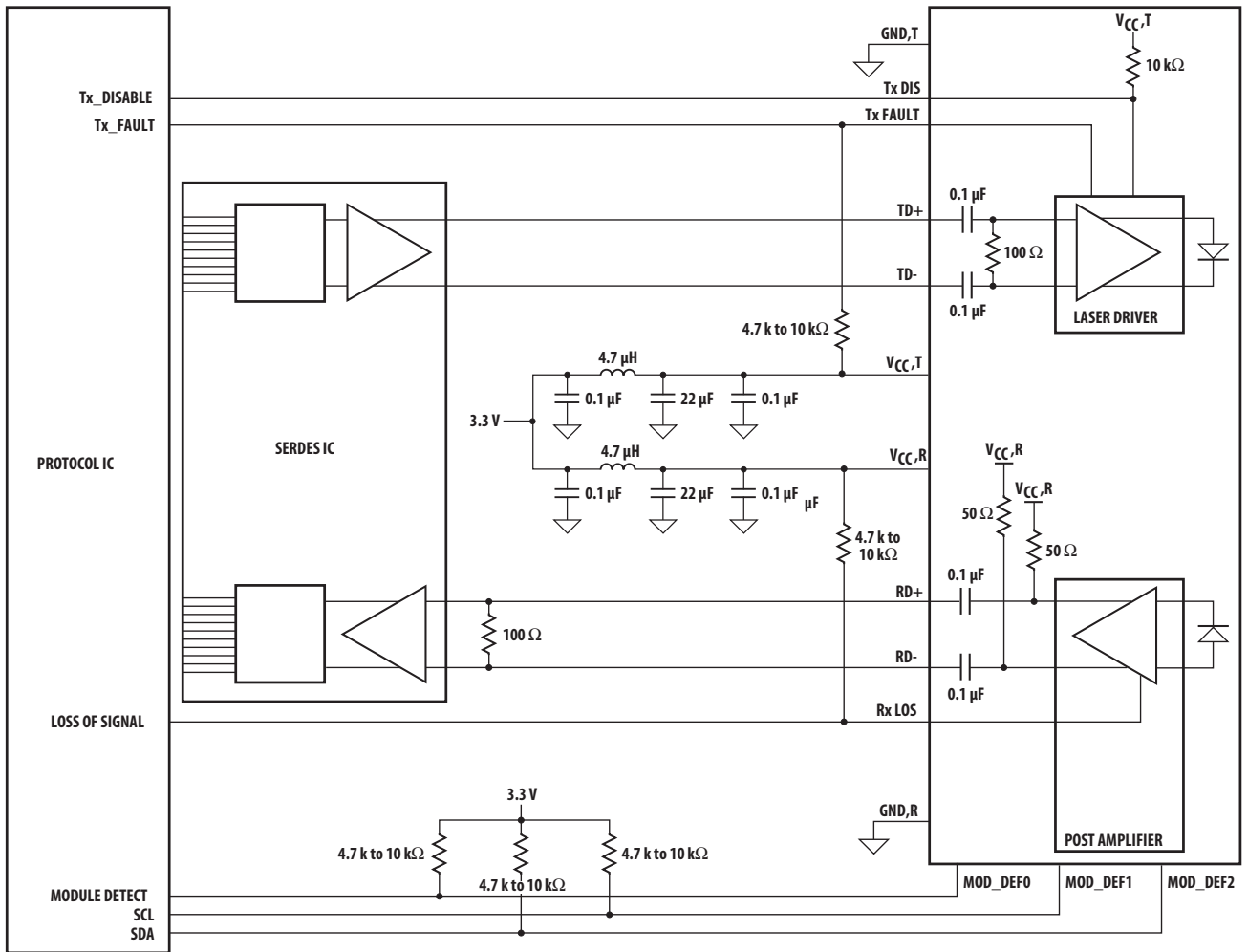
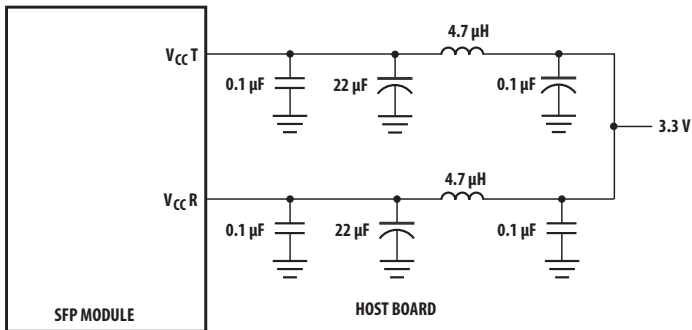

Figure 2. Typical application configuration.



NOTE: INDUCTORS MUST HAVE LESS THAN 1Ω SERIES RESISTANCE TO LIMIT VOLTAGE DROP TO THE SFP MODULE.

Figure 3. Recommended power supply filter.

**Table 2. Pin Description**

Pin	Name	Function/Description	Notes
1	VeeT	Transmitter Ground	
2	TX_FAULT	Transmitter Fault Indication – High indicates a fault condition	Note 1
3	TX_DISABLE	Transmitter Disable – Module electrical input disables on high or open	Note 2
4	MOD-DEF2	Module Definition 2 – Two wire serial ID interface data line (SDA)	Note 3
5	MOD-DEF1	Module Definition 1 – Two wire serial ID interface clock line (SCL)	Note 3
6	MOD-DEF0	Module Definition 0 – Grounded in module (module present indicator)	Note 3
7	No Connect	Internal pullup 30K $\Omega$ to Vcc	
8	RX_LOS	Loss of Signal – High indicates loss of received optical signal	Note 4
9	No Connect	Internal pullup 30K $\Omega$ to Vcc	
10	VeeR	Receiver Ground	
11	VeeR	Receiver Ground	
12	RD-	Inverse Received Data Out	Note 5
13	RD+	Received Data Out	Note 5
14	VeeR	Receiver Ground	
15	VccR	Receiver Power + 3.3 V	Note 6
16	VccT	Transmitter Power + 3.3 V	Note 6
17	VeeT	Transmitter Ground	
18	TD+	Transmitter Data In	Note 7
19	TD-	Inverse Transmitter Data In	Note 7
20	VeeT	Transmitter Ground	

**Notes:**

- TX\_FAULT is an open collector/drain output, which must be pulled up with a 4.7 k – 10 k $\Omega$  resistor on the host board. When high, this output indicates a laser fault of some kind. Low indicates normal operation. In the low state, the output will be pulled to < 0.8V.
- TX\_DISABLE is an input that is used to shut down the transmitter optical output. It is internally pulled up (within the transceiver) with a 6.8 k $\Omega$  resistor.

Low (0 – 0.8V):	Transmitter on
Between (0.8V and 2.0V):	Undefined
High (2.0 – Vcc max) or OPEN:	Transmitter Disabled
- The signals Mod-Def 0, 1, 2 designate the two wire serial interface pins. They must be pulled up with a 4.7 k – 10 k $\Omega$  resistor on the host board.
  - Mod-Def 0 is grounded by the module to indicate the module is present
  - Mod-Def 1 is serial clock line (SCL) of two wire serial interface
  - Mod-Def 2 is serial data line (SDA) of two wire serial interface
- RX\_LOS (Rx Loss of Signal) is an open collector/drain output that must be pulled up with a 4.7 k – 10 k $\Omega$  resistor on the host board. When high, this output indicates the received optical power is below the worst case receiver sensitivity (as defined by the standard in use). Low indicates normal operation. In the low state, the output will be pulled to < 0.8V.
- RD-/+ designate the differential receiver outputs. They are AC coupled 100 $\Omega$  differential lines which should be terminated with 100 $\Omega$  differential at the host SERDES input. AC coupling is done inside the transceiver and is not required on the host board. The voltage swing on these lines will be between 370 and 850 mV differential (185 – 425 mV single ended) when properly terminated.
- VccR and VccT are the receiver and transmitter power supplies. They are defined at the SFP connector pin. The maximum supply current is 300 mA and the associated in-rush current will typically be no more than 30 mA above steady state after 2 microseconds.
- TD-/+ designate the differential transmitter inputs. They are AC coupled differential lines with 100 $\Omega$  differential termination inside the module. The AC coupling is done inside the module and is not required on the host board. The inputs will accept differential swings of 180 – 1200 mV (90 – 600 mV single ended)



**Table 3. Absolute Maximum Ratings**

Parameter	Symbol	Minimum	Maximum	Unit	Notes
Storage Temperature	T <sub>S</sub>	-40	85	C	Note 1, 2
Case Operating Temperature	T <sub>C</sub>	-40	85	C	Note 1, 2
Relative Humidity (Non condensing)	RH	5	95	%	Note 1
Supply Voltage	V <sub>CC,T,R</sub>	-0.5	3.8	V	Note 1, 2, 3
Low Speed Input Voltage	V <sub>IN</sub>	-0.5	V <sub>CC</sub> +0.5	V	Note 1

**Notes:**

1. Absolute Maximum Ratings are those values beyond which damage to the device may occur if these limits are exceeded for other than a short period of time. See Reliability Data Sheet for specific reliability performance.
2. Between Absolute Maximum Ratings and the Recommended Operating Conditions functional performance is not intended, device reliability is not implied, and damage to the device may occur over an extended period of time.
3. The module supply voltages, V<sub>CC</sub>T and V<sub>CC</sub>R must not differ by more than 0.5 V or damage to the device may occur.

**Table 4. Recommended Operating Conditions**

Parameter	Symbol	Minimum	Maximum	Unit	Notes
Case Operating Temperature	T <sub>C</sub>	-10	85	°C	Note 1, 2
Supply Voltage	V <sub>CC,T,R</sub>	2.97	3.63	V	Note 2
Data Rate		2.125	8.5	Gb/s	Note 2

**Notes:**

1. The Ambient Operating Temperature limitations are based on the Case Operating Temperature limitations and are subject to the host system thermal design.
2. Recommended Operating Conditions are those values for which functional performance and device reliability is implied.

**Table 5. Transceiver Electrical Characteristics**(T<sub>C</sub> = -10°C to 85°C, V<sub>CC</sub>T, V<sub>CC</sub>R = 3.3 V ±10%)

Parameter	Symbol	Minimum	Typical	Maximum	Unit	Notes
<b>AC Electrical Characteristics</b>						
Power Supply Noise Rejection (peak-peak)	PSNR			100 10Hz to 10MHz	mV	Note 1
<b>DC Electrical Characteristics</b>						
Module Supply Current	I <sub>CC</sub>			235	mA	
Power Dissipation	P <sub>DISS</sub>			825	mW	
Low Speed Outputs:	V <sub>OH</sub>	2.0		V <sub>CC,T,R</sub> +0.3	V	Note 2
Transmit Fault (TX_FAULT), Loss of Signal (RX_LOS), MOD-DEF 2	V <sub>OL</sub>			0.4	V	
Low Speed Inputs:	V <sub>IH</sub>	2.0		V <sub>CC</sub>	V	Note 3
Transmit Disable (TX_DIS), MOD-DEF 1, MOD-DEF2,	V <sub>IL</sub>	0		0.8	V	

**Notes:**

1. Filter per SFP specification is required on host board to remove 10 Hz to 2 MHz content.
2. Pulled up externally with a 4.7 k – 10 kΩ resistor on the host board to 3.3 V.
3. Mod-Def1 and Mod-Def2 must be pulled up externally with a 4.7 k – 10 kΩ resistor on the host board to 3.3 V.



**Table 6. Transmitter and Receiver Electrical Characteristics**(T<sub>C</sub> = -10°C to 85°C, V<sub>ccT</sub>, V<sub>ccR</sub> = 3.3V ±10%)

Parameter	Symbol	Minimum	Typical	Maximum	Unit	Notes
High Speed Data Input: Transmitter Differential Input Voltage (TD +/-)	V <sub>I</sub>	180		1200	mV	Note 1
High Speed Data Output: Receiver Differential Output Voltage (RD +/-)	V <sub>O</sub>	370		850	mV	Note 2
Receiver Total Jitter (8.5 Gb/s)	TJ			0.71 83.5	UI ps	Note 4
Receiver Deterministic Jitter (8.5 Gb/s)	DJ			0.42 49.4	UI ps	
Receiver Data Dependent Pulse Width Shrinkage (8.5 Gb/s)	DDPWS			0.36 42.4	UI ps	
Receiver Contributed Total Jitter (4.25 Gb/s)	TJ			0.26 61.8	UI ps	Note 3
Receiver Contributed Total Jitter (2.125 Gb/s)	TJ			0.26 123.5	UI ps	Note 3

**Notes:**

1. Internally AC coupled and terminated (100 Ohm differential).
2. Internally AC coupled but requires an external load termination (100 Ohm differential).
3. Contributed DJ is measured on an oscilloscope in average mode with 50% threshold and K28.5 pattern. Contributed TJ is the sum of contributed RJ and contributed DJ. Contributed RJ is calculated for  $1 \times 10^{-12}$  BER by multiplying the RMS jitter (measured on a single rise or fall edge) from the oscilloscope by 14. Per FC-PI-4 (Table 13 - MM jitter output, note 1), the actual contributed RJ is allowed to increase above its limit if the actual contributed DJ decreases below its limits, as long as the component output DJ and TJ remain within their specified FC-PI-4 maximum limits with the worst case specified component jitter input.
4. Receiver output jitter for 8.5 Gb/s is specified differently than other data rates. Incoming optical jitter is controlled by TWDP and stressed receiver sensitivity - and is not explicitly defined. Therefore "contributed" jitter cannot be calculated. Instead, Fibre Channel standard FC-PI-4 controls the receiver output specification of TJ, DJ and DDPWS.

**Table 7. Transmitter Optical Characteristics**(T<sub>C</sub> = -10°C to 85°C, V<sub>ccT</sub>, V<sub>ccR</sub> = 3.3V ±10%)

Parameter	Symbol	Minimum	Typical	Maximum	Unit	Notes
Modulated Optical Output Power (OMA) (Peak-to-Peak) 8.5 Gb/s	T <sub>x,OMA</sub>	302			μW	Note 1
Modulated Optical Output Power (OMA) (Peak-to-Peak) 4.25 Gb/s	T <sub>x,OMA</sub>	247			μW	Note 2
Modulated Optical Output Power (OMA) (Peak-to-Peak) 2.125 Gb/s	T <sub>x,OMA</sub>	196			μW	Note 3
Average Optical Output Power	P <sub>out</sub>	-8.2		0	dBm	Note 4
Center Wavelength	λ <sub>C</sub>	840		860	nm	
Spectral Width – rms	σ,rms			0.65	nm	
Optical Rise/Fall Time (8.5 Gb/s)	t <sub>r</sub> , t <sub>f</sub>		40		ps	20% - 80%
RIN <sub>12</sub> (OMA)	RIN			-128	dB/Hz	
Transmitter Waveform Distortion Penalty (8.5 Gb/s)	TWDP			4.3	dB	
Transmitter Uncorrelated Jitter (8.5 Gb/s)	UJ			0.03 3.5	UI ps	Note 5
Transmitter Contributed Total Jitter (4.25 Gb/s)	TJ			0.25 59.8	UI ps	Note 5
Transmitter Contributed Total Jitter (2.125 Gb/s)	TJ			0.25 119.6	UI ps	Note 5
P <sub>out</sub> TX_DISABLE Asserted	P <sub>OFF</sub>			-30	dBm	

## Notes:

1. An OMA of 302 μW is approximately equal to an average power of -7 dBm, avg assuming an Extinction Ratio of 9 dB.
2. An OMA of 247 μW is approximately equal to an average power of -8 dBm, avg assuming an Extinction Ratio of 9 dB.
3. An OMA of 196 μW is approximately equal to an average power of -9 dBm, avg assuming an Extinction Ratio of 9 dB.
4. Into 50/125 μm (0.2 NA) multi-mode optical fiber.
5. Contributed DJ is measured on an oscilloscope in average mode with 50% threshold and K28.5 pattern. Contributed TJ is the sum of contributed RJ and contributed DJ. Contributed RJ is calculated for 1x10<sup>-12</sup> BER by multiplying the RMS jitter (measured on a single rise or fall edge) from the oscilloscope by 14. Per FC-PI-4 (Table 13 - MM jitter output, note 1), the actual contributed RJ is allowed to increase above its limit if the actual contributed DJ decreases below its limits, as long as the component output DJ and TJ remain within their specified FC-PI-4 maximum limits with the worst case specified component jitter input.

**Table 8. Receiver Optical Characteristics**(T<sub>C</sub> = -10°C to 85°C, V<sub>ccT</sub>, V<sub>ccR</sub> = 3.3 V ±10%)

Parameter	Symbol	Min.	Typ.	Max.	Unit	Notes
Input Optical Power [Overdrive]	P <sub>IN</sub>			0	dBm, avg	
Input Optical Modulation Amplitude (Peak-to-Peak) 8.5 Gb/s [Sensitivity]	OMA	76			μW, OMA	Notes 1
Input Optical Modulation Amplitude (Peak-to-Peak) 4.25 Gb/s [Sensitivity]	OMA	61			μW, OMA	Notes 1, 2
Input Optical Modulation Amplitude (Peak-to-Peak) 2.125 Gb/s [Sensitivity]	OMA	49			μW, OMA	Notes 1, 3
Stressed Receiver Sensitivity (OMA) 8.5 Gb/s		148			uW, OMA	50/125um OM3 fiber, Note 4
		151			μW, OMA	50/125 μm OM2 fiber, Note 4
		155			μW, OMA	62.5/125 μm fiber, Note 4
Stressed Receiver Sensitivity (OMA) 4.25 Gb/s		126			uW, OMA	50/125um OM3 fiber, Note 5
		138			μW, OMA	50/125 μm OM2 fiber, Note 5
		148			μW, OMA	62.5/125 μm fiber, Note 5
Stressed Receiver Sensitivity (OMA) 2.125 Gb/s		83			uW, OMA	50/125um OM3 fiber, Note 6
		96			μW, OMA	50/125 μm OM2 fiber, Note 6
		109			μW, OMA	62.5/125 μm fiber, Note 6
Return Loss		12			dB	
Loss of Signal – Assert	P <sub>A</sub>	-30			dBm, avg	Note 7
Loss of Signal - De-Assert	P <sub>D</sub>			-13.9	dBm, avg	Note 7
Loss of Signal Hysteresis	P <sub>D</sub> - P <sub>A</sub>	0.5			dB	

**Notes:**

1. Input Optical Modulation Amplitude (commonly known as sensitivity) requires a valid 8B/10B encoded input.
2. An OMA of 61 μW is approximately equal to an average power of -14 dBm, avg with an Extinction Ratio of 9 dB.
3. An OMA of 49 μW is approximately equal to an average power of -15 dBm, avg with an Extinction Ratio of 9 dB.
4. 8.5 Gb/s stressed receiver vertical eye closure penalty (ISI) min. is 3.45 dB for 50 μm fiber and 3.52 dB for 62.5 μm fiber.
5. 4.25 Gb/s stressed receiver vertical eye closure penalty (ISI) min. is 1.67 dB for 50 μm fiber and 2.14 dB for 62.5 μm fiber.
6. 2.125 Gb/s stressed receiver vertical eye closure penalty (ISI) min. is 1.26 dB for 50 μm fiber and 2.03 dB for 62.5 μm fiber.
7. These average power values are specified with an Extinction Ratio of 6 dB. The loss of signal circuitry responds to valid 8B/10B encoded peak to peak input optical power, not average power.

**Table 9. Transceiver SOFT DIAGNOSTIC Timing Characteristics**(T<sub>C</sub> = -10°C to 85°C, V<sub>ccT</sub>, V<sub>ccR</sub> = 3.3V ±10%)

Parameter	Symbol	Minimum	Maximum	Unit	Notes
Hardware TX_DISABLE Assert Time	t <sub>off</sub>		10	µs	Note 1
Hardware TX_DISABLE Negate Time	t <sub>on</sub>		1	ms	Note 2
Time to initialize, including reset of TX_FAULT	t <sub>init</sub>		300	ms	Note 3
Hardware TX_FAULT Assert Time	t <sub>fault</sub>		1	ms	Note 4
Hardware TX_DISABLE to Reset	t <sub>reset</sub>	10		µs	Note 5
Hardware RX_LOS Deassert Time	t <sub>loss_on</sub>		100	µs	Note 6
Hardware RX_LOS Assert Time	t <sub>loss_off</sub>		100	µs	Note 7
Software TX_DISABLE Assert Time	t <sub>off_soft</sub>		100	ms	Note 8
Software TX_DISABLE Negate Time	t <sub>on_soft</sub>		100	ms	Note 9
Software Tx_FAULT Assert Time	t <sub>fault_soft</sub>		100	ms	Note 10
Software Rx_LOS Assert Time	t <sub>loss_on_soft</sub>		100	ms	Note 11
Software Rx_LOS Deassert Time	t <sub>loss_off_soft</sub>		100	ms	Note 12
Analog parameter data ready	t <sub>data</sub>		1000	ms	Note 13
Serial bus hardware ready	t <sub>serial</sub>		300	ms	Note 14
Serial bus buffer time	t <sub>buf</sub>	20		µs	Note 16
Write Cycle Time	t <sub>write</sub>		80	ms	Note 15
Serial ID Clock Rate	f <sub>serial_clock</sub>		400	kHz	Note 17

**Notes:**

1. Time from rising edge of TX\_DISABLE to when the optical output falls below 10% of nominal.
2. Time from falling edge of TX\_DISABLE to when the modulated optical output rises above 90% of nominal.
3. Time from power on or falling edge of Tx\_Disable to when the modulated optical output rises above 90% of nominal.
4. From power on or negation of TX\_FAULT using TX\_DISABLE.
5. Time TX\_DISABLE must be held high to reset the laser fault shutdown circuitry.
6. Time from loss of optical signal to Rx\_LOS Assertion.
7. Time from valid optical signal to Rx\_LOS De-Assertion.
8. Time from two-wire interface assertion of TX\_DISABLE (A2h, byte 110, bit 6) to when the optical output falls below 10% of nominal. Measured from falling clock edge after stop bit of write transaction.
9. Time from two-wire interface de-assertion of TX\_DISABLE (A2h, byte 110, bit 6) to when the modulated optical output rises above 90% of nominal.
10. Time from fault to two-wire interface TX\_FAULT (A2h, byte 110, bit 2) asserted.
11. Time for two-wire interface assertion of Rx\_LOS (A2h, byte 110, bit 1) from loss of optical signal.
12. Time for two-wire interface de-assertion of Rx\_LOS (A2h, byte 110, bit 1) from presence of valid optical signal.
13. From power on to data ready bit asserted (A2h, byte 110, bit 0). Data ready indicates analog monitoring circuitry is functional.
14. Time from power on until module is ready for data transmission over the serial bus (reads or writes over A0h and A2h).
15. Time from stop bit to completion of a 1-8 byte write command. For a one to four byte write the maximum cycle time is 40ms and for a five to eight byte write the maximum cycle time is 80ms.
16. Time between STOP and START commands.
17. Module may clock stretch for f<sub>serial\_clock</sub> greater than 100 kHz.

**Table 10. Transceiver Digital Diagnostic Monitor (Real Time Sense) Characteristics**

( $T_C = -10^\circ\text{C}$  to  $85^\circ\text{C}$ ,  $V_{CC,T}, V_{CC,R} = 3.3\text{V} \pm 10\%$ )

Parameter	Symbol	Min.	Units	Notes
Transceiver Internal Temperature Accuracy	$T_{INT}$	$\pm 3.0$	$^\circ\text{C}$	Temperature is measured internal to the transceiver. Valid from $-10^\circ\text{C}$ to $85^\circ\text{C}$ case temperature.
Transceiver Internal Supply Voltage Accuracy	$V_{INT}$	$\pm 0.1$	V	Supply voltage is measured internal to the transceiver and can, with less accuracy, be correlated to voltage at the SFP Vcc pin. Valid over $3.3\text{V} \pm 10\%$ .
Transmitter Laser DC Bias Current Accuracy	$I_{INT}$	$\pm 10$	%	$I_{INT}$ is better than $\pm 10\%$ of the nominal value.
Transmitted Average Optical Output Power Accuracy	$P_T$	$\pm 3.0$	dB	Coupled into $50/125\ \mu\text{m}$ multi-mode fiber. Valid from $100\ \mu\text{W}$ to $500\ \mu\text{W}$ , avg.
Received Average Optical Input Power Accuracy	$P_R$	$\pm 3.0$	dB	Coupled from $50/125\ \mu\text{m}$ multi-mode fiber. Valid from $49\ \mu\text{W}$ to $500\ \mu\text{W}$ , avg.

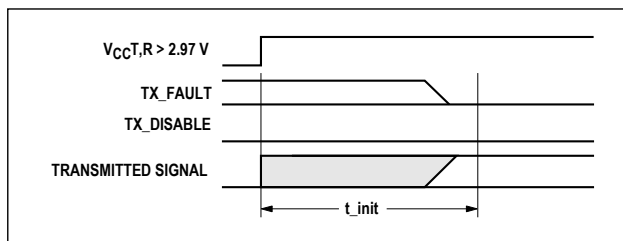

t-init: TX DISABLE NEGATED

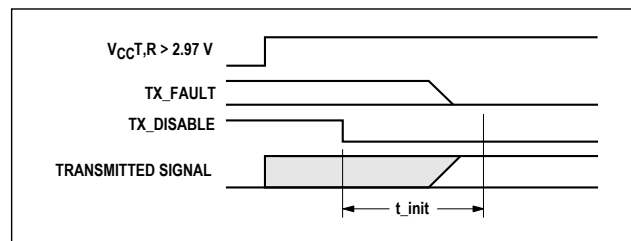

t-init: TX DISABLE ASSERTED

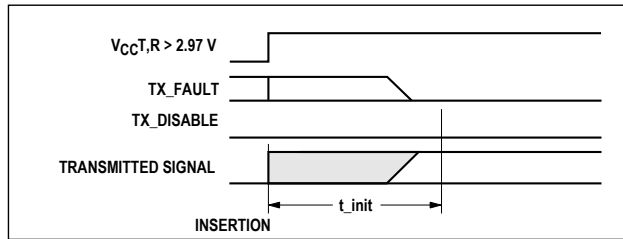

t-init: TX DISABLE NEGATED, MODULE HOT PLUGGED

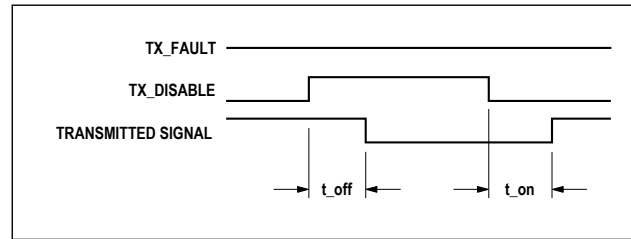

t-off & t-on: TX DISABLE ASSERTED THEN NEGATED

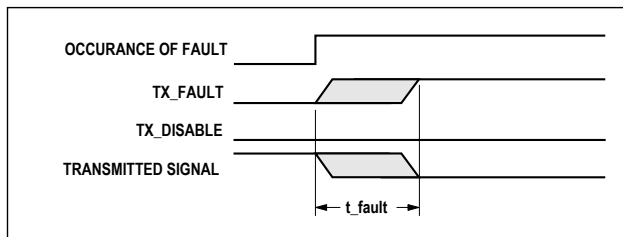

t-fault: TX FAULT ASSERTED, TX SIGNAL NOT RECOVERED

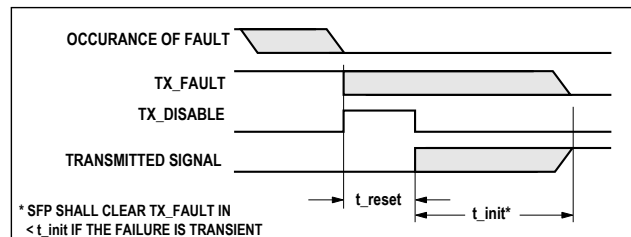

t-reset: TX DISABLE ASSERTED THEN NEGATED, TX SIGNAL RECOVERED

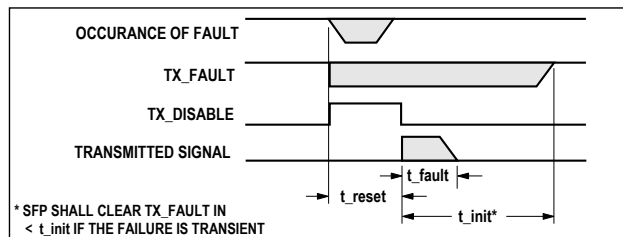

t-fault: TX DISABLE ASSERTED THEN NEGATED, TX SIGNAL NOT RECOVERED

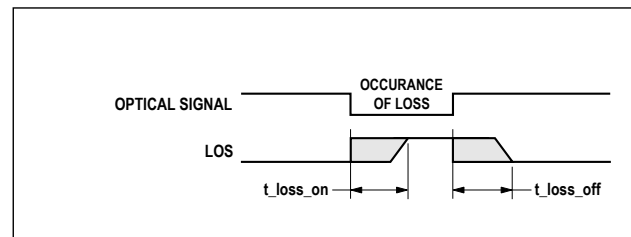

t-loss-on & t-loss-off

**Figure 4. Transceiver timing diagrams (module installed except where noted).**

**Table 12. EEPROM Serial ID Memory Contents – Conventional SFP Memory (Address A0h)**

Byte # Decimal	Data Hex	Notes	Byte # Decimal	Data Hex	Notes
0	03	SFP physical device	37	00	Hex Byte of Vendor OUI <sup>[4]</sup>
1	04	SFP function defined by serial ID only	38	17	Hex Byte of Vendor OUI <sup>[4]</sup>
2	07	LC optical connector	39	6A	Hex Byte of Vendor OUI <sup>[4]</sup>
3	00		40	41	"A" - Vendor Part Number ASCII character
4	00		41	46	"F" - Vendor Part Number ASCII character
5	00		42	42	"B" - Vendor Part Number ASCII character
6	00		43	52	"R" - Vendor Part Number ASCII character
7	20	Intermediate distance (per FC-PI)	44	2D	"-" - Vendor Part Number ASCII character
8	40	Shortwave laser without OFC (open fiber control)	45	35	"5" - Vendor Part Number ASCII character
9	0C	Multi-mode 50 µm and 62.5 µm optical media	46	37	"7" - Vendor Part Number ASCII character
10	54	200, 400 & 800 Mbytes/sec FC-PI-4 speed <sup>[1]</sup>	47	44	"D" - Vendor Part Number ASCII character
11	01	Compatible with 8B/10B encoded data	48	39	"9" - Vendor Part Number ASCII character
12	55	8500 MBit/sec nominal bit rate (8.5 Gbit/s)	49	41	"A" - Vendor Part Number ASCII character
13	00		50	4D	"M" - Vendor Part Number ASCII character
14	00		51	5A	"Z" - Vendor Part Number ASCII character
15	00		52	20	" " - Vendor Part Number ASCII character
16	05	50 m of OM2 50/125 µm fiber @ 8.5Gbit/sec <sup>[2]</sup>	53	20	" " - Vendor Part Number ASCII character
17	03	25 m of OM1 62.5/125 µm fiber @ 8.5Gbit/sec <sup>[3]</sup>	54	20	" " - Vendor Part Number ASCII character
18	00		55	20	" " - Vendor Part Number ASCII character
19	0F	150 m of OM3 50/125 µm fiber @ 8.5Gbit/sec <sup>[9]</sup>	56	20	" " - Vendor Part Number ASCII character
20	41	"A" - Vendor Name ASCII character	57	20	" " - Vendor Part Number ASCII character
21	56	"V" - Vendor Name ASCII character	58	20	" " - Vendor Part Number ASCII character
22	41	"A" - Vendor Name ASCII character	59	20	" " - Vendor Part Number ASCII character
23	47	"G" - Vendor Name ASCII character	60	03	Hex Byte of Laser Wavelength <sup>[5]</sup>
24	4F	"O" - Vendor Name ASCII character	61	52	Hex Byte of Laser Wavelength <sup>[5]</sup>
25	20	" " - Vendor Name ASCII character	62	00	
26	20	" " - Vendor Name ASCII character	63		Checksum for Bytes 0-62 <sup>[6]</sup>
27	20	" " - Vendor Name ASCII character	64	00	Receiver limiting output. 1 Watt power class.
28	20	" " - Vendor Name ASCII character	65	1A	Hardware SFP TX_DISABLE, TX_FAULT, & RX_LOS,
29	20	" " - Vendor Name ASCII character	66	00	
30	20	" " - Vendor Name ASCII character	67	00	
31	20	" " - Vendor Name ASCII character	68-83		Vendor Serial Number ASCII characters <sup>[7]</sup>
32	20	" " - Vendor Name ASCII character	84-91		Vendor Date Code ASCII characters <sup>[8]</sup>
33	20	" " - Vendor Name ASCII character	92	68	Digital Diagnostics, Internal Cal, Rx Pwr Avg
34	20	" " - Vendor Name ASCII character	93	F0	A/W, Soft SFP TX_DISABLE, TX_FAULT, & RX_LOS,
35	20	" " - Vendor Name ASCII character	94	03	SFF-8472 Compliance to revision 10.2
36	00		95		Checksum for Bytes 64-94 <sup>[6]</sup>
			96 - 255	00	

**Notes:**

1. FC-PI speed 800 MBytes/sec is a serial bit rate of 8.5 Gbit/sec. 200 MBytes/sec is a serial bit rate of 2.125 Gbit/sec. 400 MBytes/sec is a serial bit rate of 4.25 Gbit/sec.
2. Link distance with OM2 50/125 µm cable at 4.25 Gbit/sec is 150 m. Link distance at 2.125 Gbit/sec is 300 m.
3. Link distance with OM1 62.5/125 µm cable at 4.25 Gbit/sec is 70 m. Link distance at 2.125 Gbit/sec is 150 m.
4. The IEEE Organizationally Unique Identifier (OUI) assigned to Avago Technologies is 00-17-6A (3 bytes of hex).
5. Laser wavelength is represented in 16 unsigned bits. The hex representation of 850 (nm) is 0352.
6. Addresses 63 and 95 are checksums calculated (per SFF-8472 and SFF-8074) and stored prior to product shipment.
7. Addresses 68-83 specify the AFBR-57D9AMZ ASCII serial number and will vary on a per unit basis.
8. Addresses 84-91 specify the AFBR-57D9AMZ ASCII date code and will vary on a per date code basis.
9. Link distance with OM3 50/125 µm cable at 4.25 Gbit/sec is 380 m. Link distance at 2.125 Gbit/sec is 500 m.

**Table 13. EEPROM Serial ID Memory Contents – Enhanced Feature Set Memory (Address A2h)**

Byte # Decimal	Notes	Byte # Decimal	Notes	Byte # Decimal	Notes
0	Temp H Alarm MSB <sup>[1]</sup>	26	Tx Pwr L Alarm MSB <sup>[4]</sup>	104	Real Time Rx Pwr MSB <sup>[5]</sup>
1	Temp H Alarm LSB <sup>[1]</sup>	27	Tx Pwr L Alarm LSB <sup>[4]</sup>	105	Real Time Rx Pwr LSB <sup>[5]</sup>
2	Temp L Alarm MSB <sup>[1]</sup>	28	Tx Pwr H Warning MSB <sup>[4]</sup>	106	Reserved
3	Temp L Alarm LSB <sup>[1]</sup>	29	Tx Pwr H Warning LSB <sup>[4]</sup>	107	Reserved
4	Temp H Warning MSB <sup>[1]</sup>	30	Tx Pwr L Warning MSB <sup>[4]</sup>	108	Reserved
5	Temp H Warning LSB <sup>[1]</sup>	31	Tx Pwr L Warning LSB <sup>[4]</sup>	109	Reserved
6	Temp L Warning MSB <sup>[1]</sup>	32	Rx Pwr H Alarm MSB <sup>[5]</sup>	110	Status/Control - See Table 14
7	Temp L Warning LSB <sup>[1]</sup>	33	Rx Pwr H Alarm LSB <sup>[5]</sup>	111	Reserved
8	Vcc H Alarm MSB <sup>[2]</sup>	34	Rx Pwr L Alarm MSB <sup>[5]</sup>	112	Flag Bits - See Table 15
9	Vcc H Alarm LSB <sup>[2]</sup>	35	Rx Pwr L Alarm LSB <sup>[5]</sup>	113	Flag Bits - See Table 15
10	Vcc L Alarm MSB <sup>[2]</sup>	36	Rx Pwr H Warning MSB <sup>[5]</sup>	114	Reserved
11	Vcc L Alarm LSB <sup>[2]</sup>	37	Rx Pwr H Warning LSB <sup>[5]</sup>	115	Reserved
12	Vcc H Warning MSB <sup>[2]</sup>	38	Rx Pwr L Warning MSB <sup>[5]</sup>	116	Flag Bits - See Table 15
13	Vcc H Warning LSB <sup>[2]</sup>	39	Rx Pwr L Warning LSB <sup>[5]</sup>	117	Flag Bits - See Table 15
14	Vcc L Warning MSB <sup>[2]</sup>	40-55	Reserved	118-127	Reserved
15	Vcc L Warning LSB <sup>[2]</sup>	56-94	External Calibration Constants <sup>[6]</sup>	128-247	Customer Writeable
16	Tx Bias H Alarm MSB <sup>[3]</sup>	95	Checksum for Bytes 0-94 <sup>[7]</sup>	248-255	Vendor Specific
17	Tx Bias H Alarm LSB <sup>[3]</sup>	96	Real Time Temperature MSB <sup>[1]</sup>		
18	Tx Bias L Alarm MSB <sup>[3]</sup>	97	Real Time Temperature LSB <sup>[1]</sup>		
19	Tx Bias L Alarm LSB <sup>[3]</sup>	98	Real Time Vcc MSB <sup>[2]</sup>		
20	Tx Bias H Warning MSB <sup>[3]</sup>	99	Real Time Vcc LSB <sup>[2]</sup>		
21	Tx Bias H Warning LSB <sup>[3]</sup>	100	Real Time Tx Bias MSB <sup>[3]</sup>		
22	Tx Bias L Warning MSB <sup>[3]</sup>	101	Real Time Tx Bias LSB <sup>[3]</sup>		
23	Tx Bias L Warning LSB <sup>[3]</sup>	102	Real Time Tx Power MSB <sup>[4]</sup>		
24	Tx Pwr H Alarm MSB <sup>[4]</sup>	103	Real Time Tx Power LSB <sup>[4]</sup>		
25	Tx Pwr H Alarm LSB <sup>[4]</sup>				

**Notes:**

1. Temperature (Temp) is decoded as a 16 bit signed twos complement integer in increments of 1/256°C.
2. Supply Voltage (Vcc) is decoded as a 16 bit unsigned integer in increments of 100 µV.
3. Laser bias current (Tx Bias) is decoded as a 16 bit unsigned integer in increments of 2 µA.
4. Transmitted average optical power (Tx Pwr) is decoded as a 16 bit unsigned integer in increments of 0.1 µW.
5. Received average optical power (Rx Pwr) is decoded as a 16 bit unsigned integer in increments of 0.1 µW.
6. Bytes 56-94 are not intended for use with AFBR-57D9AMZ, but have been set to default values per SFF-8472.
7. Byte 95 is a checksum calculated (per SFF-8472) and stored prior to product shipment.



**Table 14. EEPROM Serial ID Memory Contents – Soft Commands (Address A2h, Byte 110)**

Bit #	Status/ Control Name	Description	Notes
7	TX_DISABLE State	Digital state of SFP TX_DISABLE Input Pin (1 = TX_DISABLE asserted)	Note 1
6	Soft TX_DISABLE	Read/write bit for changing digital state of TX_DISABLE function	Note 1, 2
5	Reserved	Unused	
4	Reserved	Unused	
3	Reserved	Unused	
2	TX_FAULT State	Digital state of the SFP TX_FAULT Output Pin (1 = TX_FAULT asserted)	Note 1
1	RX_LOS State	Digital state of the SFP RX_LOS Output Pin (1 = RX_LOS asserted)	Note 1
0	Data Ready (Bar)	Indicates transceiver is powered and real time sense data is ready. (0 = Ready)	Note 3

**Notes:**

1. The response time for soft commands of the AFBR-57D9AMZ is 100 msec as specified by the MSA SFF-8472.
2. Bit 6 is logic OR'd with the SFP TX\_DISABLE input pin 3 ... either asserted will disable the SFP transmitter.

**Table 15. EEPROM Serial ID Memory Contents – Alarms and Warnings (Address A2h, Bytes 112, 113, 116, 117)**

Byte	Bit	Flag Bit Name	Description
112	7	Temp High Alarm	Set when transceiver internal temperature exceeds high alarm threshold
	6	Temp Low Alarm	Set when transceiver internal temperature exceeds low alarm threshold
	5	Vcc High Alarm	Set when transceiver internal supply voltage exceeds high alarm threshold
	4	Vcc Low Alarm	Set when transceiver internal supply voltage exceeds low alarm threshold
	3	Tx Bias High Alarm	Set when transceiver laser bias current exceeds high alarm threshold
	2	Tx Bias Low Alarm	Set when transceiver laser bias current exceeds low alarm threshold
	1	Tx Power High Alarm	Set when transmitted average optical power exceeds high alarm threshold
	0	Tx Power Low Alarm	Set when transmitted average optical power exceeds low alarm threshold
113	7	Rx Power High Alarm	Set when received average optical power exceeds high alarm threshold
	6	Rx Power Low Alarm	Set when received average optical power exceeds low alarm threshold
	0-5	Reserved	
116	7	Temp High Warning	Set when transceiver internal temperature exceeds high warning threshold
	6	Temp Low Warning	Set when transceiver internal temperature exceeds low warning threshold
	5	Vcc High Warning	Set when transceiver internal supply voltage exceeds high warning threshold
	4	Vcc Low Warning	Set when transceiver internal supply voltage exceeds low warning threshold
	3	Tx Bias High Warning	Set when transceiver laser bias current exceeds high warning threshold
	2	Tx Bias Low Warning	Set when transceiver laser bias current exceeds low warning threshold
	1	Tx Power High Warning	Set when transmitted average optical power exceeds high warning threshold
	0	Tx Power Low Warning	Set when transmitted average optical power exceeds low warning threshold
117	7	Rx Power High Warning	Set when received average optical power exceeds high warning threshold
	6	Rx Power Low Warning	Set when received average optical power exceeds low warning threshold
	0-5	Reserved	

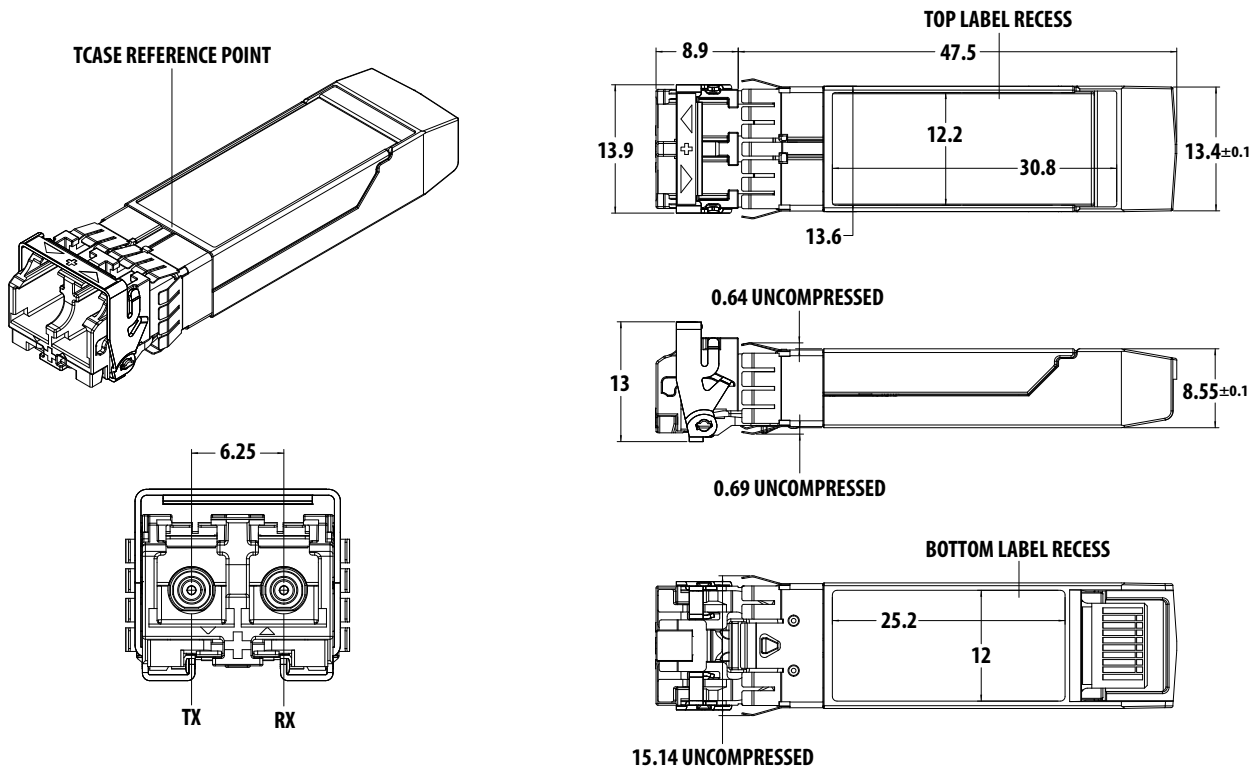

Figure 5. Module drawing



Figure 6. Module Label

### Customer Manufacturing Processes

This module is pluggable and is not designed for aqueous wash, IR reflow, or wave soldering processes.

For product information and a complete list of distributors, please go to our website: [www.avagotech.com](http://www.avagotech.com)

Avago, Avago Technologies, and the A logo are trademarks of Avago Technologies in the United States and other countries. Data subject to change. Copyright © 2005-2013 Avago Technologies. All rights reserved. AV02-3466EN - January 24, 2013

