

# Compact Three-phase and Neutral Line Filter for High Frequency Attenuation

## 3-Phase + Neutral Line Filters FN 354



- Compact four-wire filter for applications with limited space
- High attenuation performance up to 300 MHz
- Equally suitable for star and delta power networks



### Performance indicators



### Technical specifications

<b>Maximum continuous operating voltage</b>	3x 440/250 VAC
<b>Operating frequency</b>	dc to 60 Hz
<b>Rated currents</b>	4 to 25 A @ 40 °C
<b>High potential test voltage</b>	P → E 2000 VAC for 2 sec P → P 1900 VDC for 2 sec
<b>Protection category</b>	IP20 (version with -47 connections)
<b>Overload capability</b>	4x rated current at switch on, 1.5x rated current for 1 minute, once per hour
<b>Temperature range (operation and storage)</b>	-25 °C to +100 °C (25/100/21)
<b>Flammability corresponding to</b>	UL 94 V-2 or better
<b>Design corresponding to</b>	UL 1283, CSA 22.2 No. 8 1986, IEC/EN 60939
<b>MTBF @ 40°C/230V (Mil-HB-217F)</b>	500,000 hours

### Approvals



### Features and benefits

- The FN 354 family of filters is intended primarily for applications that require extremely effective interference suppression across a broad frequency spectrum.
- Advanced two-stage filter circuits with highly saturating resistant toroidal inductors, in conjunction with feedthrough capacitors on each of the three phases and the neutral line, ensure that these filters provide very high attenuation in the upper frequency band.
- FN 354 are equally suitable for the operation on star and delta power networks.

### Typical applications

- Applications requiring high-frequency attenuation
- Power supplies
- Medical equipment
- Office and data processing equipment

### Typical electrical schematic

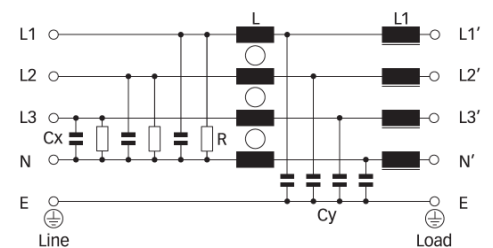

### Filter selection table

Filter	Rated current @ 40 °C (25 °C)	Leakage current* Power loss	Power loss @ 25 °C/50 Hz	Input/Output connections	Weight [kg]
	[A]	[mA]	[W]		
FN 354-4-05	4 (4.5)	0.175	2.0	-05	0.23
FN 354-6-05	6 (6.7)	0.175	3.9	-05	0.38
FN 354-12-05	12 (13.4)	0.175	7.8	-05	1.1
FN 354-15-47	15 (16.8)	0.5	10.8	-47	4.7
FN 354-25-47	25 (28)	0.5	16.9	-47	4.7

\* Maximum leakage under normal operating conditions, based on the assumption that all three phases and the neutral conductor are connected to the supply and the consumer. In this case, the current will mainly return through the neutral line, not as earth leakage.

### Typical filter attenuation

Per CISPR 17; A = 50 Ω/50 Ω sym; B = 50 Ω/50 Ω asym; C = 0.1 Ω/100 Ω sym; D = 100 Ω/0.1 Ω sym

4 and 6 A types

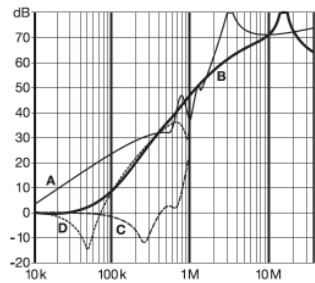

12 A types

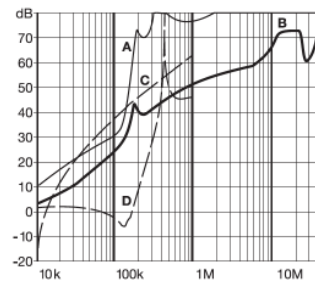

15 A types

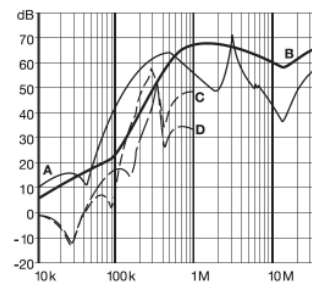

25 A types

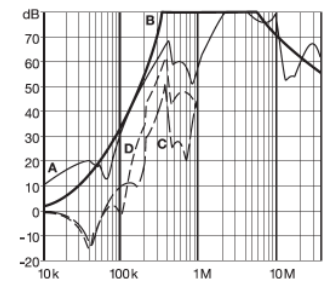

**Mechanical data**

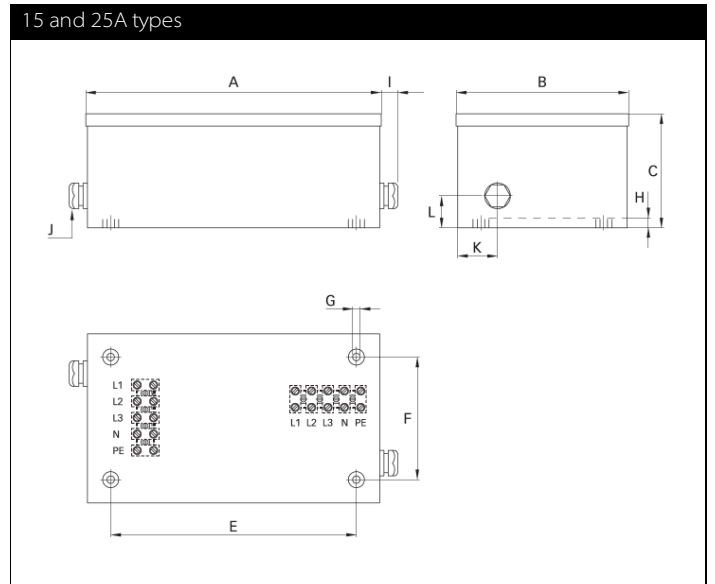
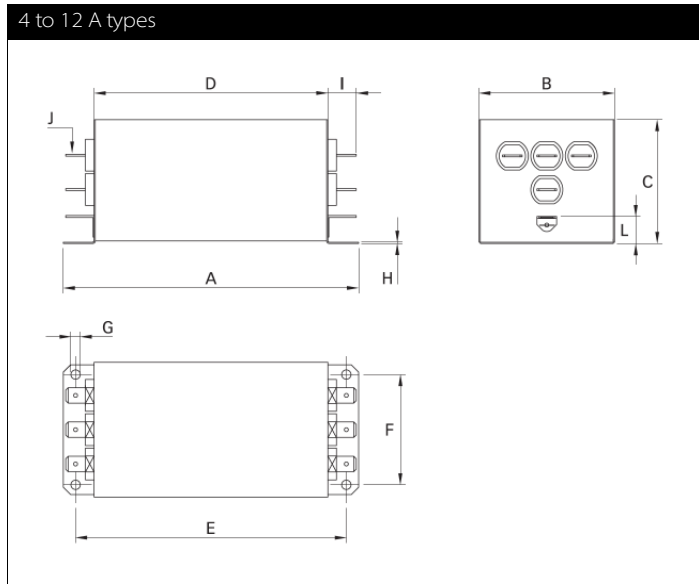

**Dimensions**

	<b>4 A</b>	<b>6 A</b>	<b>12 A</b>	<b>15 A</b>	<b>25 A</b>
<b>A</b>	103	120	150	273.6	273.6
<b>B</b>	43	55	65	158.6	158.6
<b>C</b>	40.5	50.5	60	107	107
<b>D</b>	80	95	125		
<b>E</b>	95	110	140	230	230
<b>F</b>	35	45	55	115	115
<b>G</b>	Ø3.8	Ø3.8	7.5 x 4.4	M8	M8
<b>H</b>	0.5	0.5	0.75	9.5	9.5
<b>I</b>	11.1	11.1	11.1	~20	~20
<b>J</b>	Faston 6.3 x 0.8	Faston 6.3 x 0.8	Faston 6.3 x 0.8	PG13	PG13
<b>K</b>				35.5	35.5
<b>L</b>	7	11	11	30	30

All dimensions in mm; 1 inch = 25.4 mm  
Tolerances according to ISO 2768-m / EN 22768-m

**Filter input/output connector cross sections**

	<b>-05</b>	<b>-47</b>
<b>Solid wire</b>	n/a	16 mm <sup>2</sup>
<b>Flex wire</b>	n/a	10 mm <sup>2</sup>
<b>AWG type wire</b>	n/a	AWG 8
<b>Recommended torque</b>	n/a	1.9-2.2 Nm

Please visit [www.schaffner.com](http://www.schaffner.com) to find more details on filter connectors.



## Headquarters, global innovation and development center

### Switzerland

#### Schaffner Group

Nordstrasse 11  
4542 Luterbach  
T +41 32 6816 626  
F +41 32 6816 630  
[info@schaffner.com](mailto:info@schaffner.com)  
<http://www.schaffner.com>



## Sales and application centers

### China

#### Schaffner EMC Ltd. Shanghai

T20-3, No 565 Chuangye Road  
Pudong New Area  
201201 Shanghai  
T +86 21 3813 9500  
F F +86 21 3813 9501 / 02  
[cschina@schaffner.com](mailto:cschina@schaffner.com)  
<http://www.schaffner.com.cn/>

### Finland

#### Schaffner Oy

Sauvonrinne 19 H  
08500 Lohja  
T +358 19 35 72 71  
[finlandsales@schaffner.com](mailto:finlandsales@schaffner.com)

### France

#### Schaffner EMC S.A.S.

112, Quai de Bezons  
Boîte postale 133  
95103 Argenteuil  
T +33 1 34 34 30 60  
F +33 1 39 47 02 28  
[francesales@schaffner.com](mailto:francesales@schaffner.com)

### Germany

#### Schaffner Deutschland GmbH

Schoemperlenstrasse 12B  
76185 Karlsruhe  
T +49 721 56910  
F +49 721 569110  
[germanysales@schaffner.com](mailto:germanysales@schaffner.com)

### Italy

#### Schaffner EMC S.r.l.

Via Galileo Galilei 47  
20092 Cinisello Balsamo (MI)  
T +39 02 66 04 30 45/47  
F +39 02 61 23 943  
[italysales@schaffner.com](mailto:italysales@schaffner.com)

### Japan

#### Schaffner EMC K.K.

1-32-12, Kamiyama, Setagaya-ku  
7F Mitsui-seimei Sangenjaya Bldg.  
154-0011 Tokyo  
T +81 3 5712 3650  
F +81 3 5712 3651  
[japansales@schaffner.com](mailto:japansales@schaffner.com)  
<http://www.schaffner.jp>

### Singapore

#### Schaffner EMC Pte Ltd.

Blk 3015A Ubi Road 1  
05-09 Kampong Ubi Industrial Estate  
408705 Singapore  
T +65 6377 3283  
F +65 6377 3281  
[singaporesales@schaffner.com](mailto:singaporesales@schaffner.com)

### Spain

#### Schaffner EMC España

Edificio E, Alcobendas  
El Soto de la Moraleja Alcobendas  
28109 Madrid  
T +34 618 176 133  
[spainsales@schaffner.com](mailto:spainsales@schaffner.com)

### Sweden

#### Schaffner EMC AB

Turebergstorg 1, 6  
19147 Sollentuna  
T +46 8 5792 1121 / 22  
F +46 8 92 96 90  
[swedensales@schaffner.com](mailto:swedensales@schaffner.com)

### Switzerland

#### Schaffner EMV AG

Nordstrasse 11  
4542 Luterbach  
T +41 32 6816 626  
F +41 32 6816 641  
[sales@schaffner.ch](mailto:sales@schaffner.ch)

### Taiwan R.O.C.

#### Schaffner EMV Ltd.

6 Floor, No. 413  
Rui Guang Road  
114 Neihu District Taipei City  
T +886 2 87525050  
F +886 2 87518086  
[taiwansales@schaffner.com](mailto:taiwansales@schaffner.com)

### Thailand

#### Schaffner EMC Co. Ltd.

Northern Region Industrial Estate  
67 Moo 4 Tambon Ban Klang Amphur Muang  
P.O. Box 14  
51000 Lamphun  
T +66 53 58 11 04  
F +66 53 58 10 19  
[thailandsales@schaffner.com](mailto:thailandsales@schaffner.com)

### UK

#### Schaffner Ltd.

5 Ashville Way  
Molly Millars Lane Wokingham  
RG41 2PL Berkshire  
T +44 118 9770070  
F +44 118 9792969  
[uksales@schaffner.com](mailto:uksales@schaffner.com)  
<http://www.schaffner.uk.com>

### USA

#### Schaffner EMC Inc.

52 Mayfield Avenue  
08837 Edison, New Jersey  
T +1 800 367 5566  
T +732 225 9533  
F +732 225 4789  
[usasales@schaffner.com](mailto:usasales@schaffner.com)  
<http://www.schaffner.com/us>

#### Schaffner MTC LLC

6722 Thirlane Road  
24019 Roanoke, Virginia  
T +276 228 7943  
F +276 228 7953  
<http://www.schaffnerusa.com>

#### Schaffner Trencos LLC

2550 Brookpark Road  
44134 Cleveland, Ohio  
T +216 741 5282  
F +216 741 4860  
[www.schaffner-trencos.com](http://www.schaffner-trencos.com)

To find your local partner within Schaffner's global network, please go to:  
[www.schaffner.com](http://www.schaffner.com)

© 2014 Schaffner Group

The content of this document has been carefully checked and understood. However, neither Schaffner nor its subsidiaries assume any liability whatsoever for any errors or inaccuracies of this document and the consequences thereof. Published specifications are subject to change without notice. Product suitability for any area of application must ultimately be determined by the customer. In all cases, products must never be operated outside their published specifications. Schaffner does not guarantee the availability of all published products. This disclaimer shall be governed by substantive Swiss law and resulting disputes shall be settled by the courts at the place of business of Schaffner Holding AG. Latest publications and a complete disclaimer can be downloaded from the Schaffner website. All trademarks recognized.