

Cree® XLamp® ML-C LEDs



PRODUCT DESCRIPTION

The Cree XLamp ML-C LED brings lighting-class reliability and performance to 1/3-watt LEDs. The XLamp ML-C expands Cree’s lighting-class leadership to LED bulbs and linear and distributed lighting applications. With XLamp lighting-class reliability, a wide viewing angle, uniform light output, and industry-leading chromaticity binning in a 3.5-mm X 3.5-mm package, the XLamp ML-C LED continues Cree’s history of segment-focused product innovation in LEDs for lighting applications.

The XLamp ML-C LED brings high performance and a smooth look to a wide range of lighting applications, including linear lighting, fluorescent retrofits and retail-display lighting.

FEATURES

- Available in white (2600 K to 8300 K CCT), 80-, 85- and 90-CRI minimum and royal blue
- White LEDs available in both parallel and series
- ANSI-compatible sub-bins
- Maximum drive current: 350 mA for parallel, 175 mA for series, 250 mA for royal blue
- 120° viewing angle, uniform chromaticity profile
- Electrically neutral thermal path
- RoHS-compliant

TABLE OF CONTENTS

| | |
|-------------------------------------------------------|----|
| Characteristics | 2 |
| Flux Characteristics..... | 3 |
| Relative Spectral Power Distribution . | 6 |
| Relative Luminous Flux vs. Junction Temperature | 7 |
| Electrical Characteristics..... | 8 |
| Relative Luminous Flux vs. Current .. | 9 |
| Typical Spatial Distribution..... | 11 |
| Thermal Design | 12 |
| Reflow Soldering Characteristics | 14 |
| Notes..... | 15 |
| Mechanical Dimensions..... | 17 |
| Tape and Reel | 18 |
| Packaging..... | 19 |

CHARACTERISTICS ($T_j = 25\text{ }^\circ\text{C}$)

| Characteristics | Unit | Minimum | Typical | Maximum |
|-------------------------------------------------------|----------------------------|---------|---------|---------|
| Thermal resistance, junction to solder point | $^\circ\text{C}/\text{W}$ | | 13 | |
| Viewing angle (FWHM) - white | degrees | | 120 | |
| Viewing angle (FWHM) - royal blue | degrees | | 125 | |
| Temperature coefficient of voltage - parallel | $\text{mV}/^\circ\text{C}$ | | -3.4 | |
| Temperature coefficient of voltage - series | $\text{mV}/^\circ\text{C}$ | | -6.8 | |
| Temperature coefficient of voltage - royal blue | $\text{mV}/^\circ\text{C}$ | | -3.4 | |
| ESD classification (HBM per Mil-Std-883D) - parallel | | | Class 2 | |
| ESD withstand voltage (HBM per Mil-Std-883D) - series | V | | | 8000 |
| DC forward current - parallel | mA | | | 350 |
| DC forward current - series | mA | | | 175 |
| DC forward current - royal blue | mA | | | 250 |
| Reverse voltage | V | | | -5 |
| Forward voltage (@ 100 mA) - parallel | V | | 3.2 | 3.4 |
| Forward voltage (@ 50 mA) - series | V | | 6.4 | 7.0 |
| Forward voltage (@ 100 mA) - royal blue | V | | 3.2 | 3.4 |
| LED junction temperature | $^\circ\text{C}$ | | | 150 |

FLUX CHARACTERISTICS - ML-C PARALLEL WHITE ($T_j = 25\text{ }^\circ\text{C}$)

The following table provides several base order codes for XLamp ML-C LEDs. It is important to note that the base order codes listed here are a subset of the total available order codes for the product family. For more order codes, as well as a complete description of the order-code nomenclature, please consult the XLamp ML-C LED Binning and Labeling document.

| Color | CCT Range | | Base Order Codes Min. Luminous Flux (lm) @ 100 mA | | Calculated Min. Luminous Flux (lm) @ 300 mA * | Order Code |
|----------------------|-----------|--------|---------------------------------------------------------|-----------|-----------------------------------------------------|-----------------------|
| | Min. | Max. | Group | Flux (lm) | | |
| Cool White | 5000 K | 8300 K | K2 | 30.6 | 63.1 | MLCAWT-A1-0000-000051 |
| | | | J3 | 26.8 | 55.2 | MLCAWT-A1-0000-000X51 |
| 80-CRI Cool White | 6000 K | 7000 K | K2 | 30.6 | 63.1 | MLCAWT-H1-0000-0000E1 |
| | | | J3 | 26.8 | 55.2 | MLCAWT-H1-0000-000XE1 |
| | 4750 K | 5250 K | K2 | 30.6 | 63.1 | MLCAWT-H1-0000-0000E3 |
| | | | J3 | 26.8 | 55.2 | MLCAWT-H1-0000-000XE3 |
| Warm White | 3700 K | 4300 K | K2 | 30.6 | 63.1 | MLCAWT-A1-0000-0000E5 |
| | | | J3 | 26.8 | 55.2 | MLCAWT-A1-0000-000XE5 |
| | 2800 K | 3200 K | K2 | 30.6 | 63.1 | MLCAWT-A1-0000-0000E7 |
| | | | J3 | 26.8 | 55.2 | MLCAWT-A1-0000-000XE7 |
| 80-CRI Warm White | 3700 K | 4300 K | J3 | 26.8 | 55.2 | MLCAWT-H1-0000-000XE5 |
| | 2800 K | 3200 K | J2 | 23.5 | 48.4 | MLCAWT-H1-0000-000WE7 |
| 85-CRI Warm White | 3700 K | 4300 K | J3 | 26.8 | 55.2 | MLCAWT-P1-0000-000XE5 |
| | 2800 K | 3200 K | J2 | 23.5 | 48.4 | MLCAWT-P1-0000-000WE7 |
| 90-CRI Warm White | 3700 K | 4300 K | H0 | 18.1 | 37.3 | MLCAWT-U1-0000-000VE5 |
| | 2800 K | 3200 K | J2 | 23.5 | 48.4 | MLCAWT-U1-0000-000WE7 |

Notes:

- Cree maintains a tolerance of $\pm 7\%$ on flux and power measurements, ± 0.005 on chromaticity (CCx, CCy) measurements and ± 2 on CRI measurements.
 - Typical CRI for Cool White (4300 K – 8300 K CCT) is 75.
 - Typical CRI for Warm White (2600 K – 4300 K CCT) is 80.
 - Minimum CRI for 80-CRI White is 80.
 - Minimum CRI for 85-CRI White is 85.
 - Minimum CRI for 90-CRI White is 90.
- * Calculated flux values are for reference only.

FLUX CHARACTERISTICS - ML-C SERIES WHITE ($T_j = 25\text{ }^\circ\text{C}$)

The following table provides several base order codes for XLamp ML-C LEDs. It is important to note that the base order codes listed here are a subset of the total available order codes for the product family. For more order codes, as well as a complete description of the order-code nomenclature, please consult the XLamp ML-C LED Binning and Labeling document.

| Color | CCT Range | | Base Order Codes Min. Luminous Flux (lm) @ 50 mA | | Calculated Min. Luminous Flux (lm) @ 150 mA * | Order Code |
|----------------------|-----------|--------|--------------------------------------------------------|-----------|-----------------------------------------------------|-----------------------|
| | Min. | Max. | Group | Flux (lm) | | |
| Cool White | 5000 K | 8300 K | K2 | 30.6 | 63.1 | MLCSWT-A1-0000-000051 |
| | | | J3 | 26.8 | 55.2 | MLCSWT-A1-0000-000X51 |
| 80-CRI Cool White | 6000 K | 7000 K | K2 | 30.6 | 63.1 | MLCSWT-H1-0000-0000E1 |
| | | | J3 | 26.8 | 55.2 | MLCSWT-H1-0000-000XE1 |
| | 4750 K | 5250 K | K2 | 30.6 | 63.1 | MLCSWT-H1-0000-0000E3 |
| | | | J3 | 26.8 | 55.2 | MLCSWT-H1-0000-000XE3 |
| Warm White | 3700 K | 4300 K | K2 | 30.6 | 63.1 | MLCSWT-A1-0000-0000E5 |
| | | | J3 | 26.8 | 55.2 | MLCSWT-A1-0000-000XE5 |
| | 2800 K | 3200 K | K2 | 30.6 | 63.1 | MLCSWT-A1-0000-0000E7 |
| | | | J3 | 26.8 | 55.2 | MLCSWT-A1-0000-000XE7 |
| 80-CRI Warm White | 3700 K | 4300 K | J3 | 26.8 | 55.2 | MLCSWT-H1-0000-000XE5 |
| | 2800 K | 3200 K | J2 | 23.5 | 48.4 | MLCSWT-H1-0000-000WE7 |
| 85-CRI Warm White | 3700 K | 4300 K | J3 | 26.8 | 55.2 | MLCSWT-P1-0000-000XE5 |
| | 2800 K | 3200 K | J2 | 23.5 | 48.4 | MLCSWT-P1-0000-000WE7 |
| 90-CRI Warm White | 3700 K | 4300 K | H0 | 18.1 | 37.3 | MLCSWT-U1-0000-000VE5 |
| | 2800 K | 3200 K | J2 | 23.5 | 48.4 | MLCSWT-U1-0000-000WE7 |

Notes:

- Cree maintains a tolerance of $\pm 7\%$ on flux and power measurements, ± 0.005 on chromaticity (CCx, CCy) measurements and ± 2 on CRI measurements.
- Typical CRI for Cool White (4300 K – 8300 K CCT) is 75.
- Typical CRI for Warm White (2600 K – 4300 K CCT) is 80.
- Minimum CRI for 80-CRI White is 80.
- Minimum CRI for 85-CRI White is 85.
- Minimum CRI for 90-CRI White is 90.
- * Calculated flux values are for reference only.

FLUX CHARACTERISTICS - ML-C ROYAL BLUE ($T_j = 25\text{ }^\circ\text{C}$)

The following table provides a base order code for XLamp ML-C Royal Blue LEDs. It is important to note that the base order codes listed here are a subset of the total available order codes for the product family. For more order codes, as well as a complete description of the order-code nomenclature, please consult the XLamp ML Family Binning and Labeling document.

| Color | Dominant Wavelength Range | | | | Base Order Codes Minimum Radiant Flux (mW) @ 100 mA | | Order Code |
|------------|---------------------------|-------------|-------|-------------|--------------------------------------------------------------|--------------|-----------------------|
| | Min. | | Max. | | Group | Flux (mW) | |
| | Group | DWL (nm) | Group | DWL (nm) | | | |
| Royal Blue | D3 | 450 | D5 | 465 | 07 | 100 | MLCROY-A1-0000-000201 |

Note: Cree maintains a tolerance of $\pm 7\%$ on flux and power measurements and $\pm 1\text{ nm}$ on dominant wavelength measurements.

RELATIVE SPECTRAL POWER DISTRIBUTION - WHITE

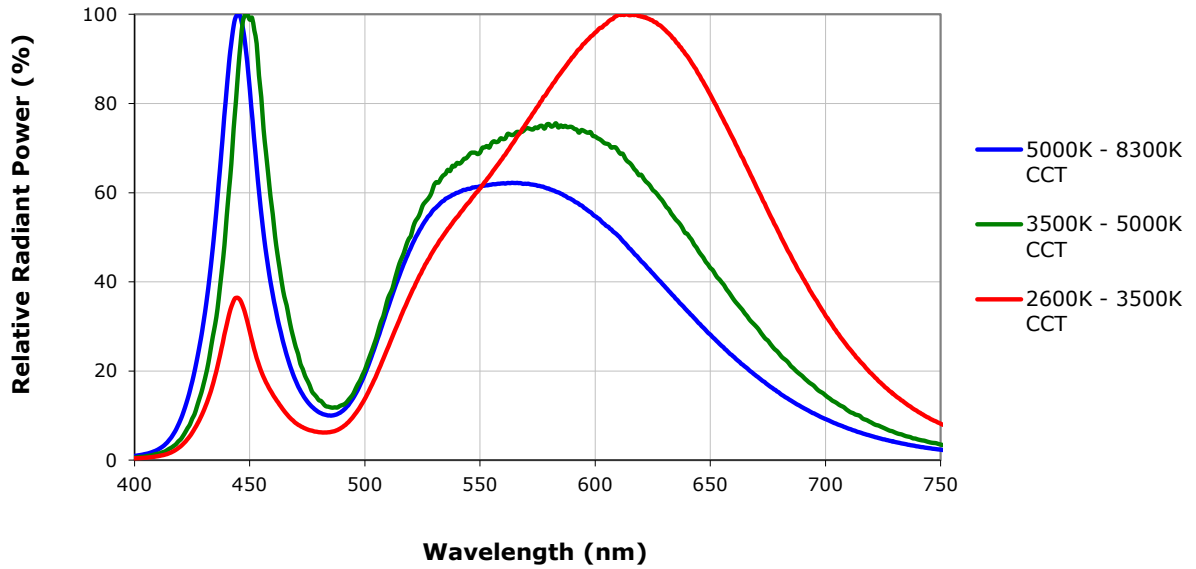

RELATIVE SPECTRAL POWER DISTRIBUTION - ROYAL BLUE

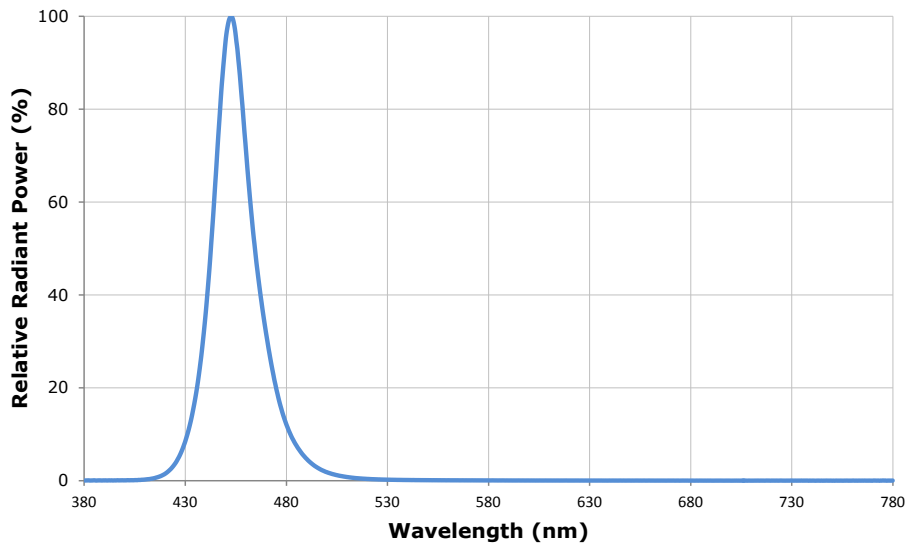

**RELATIVE LUMINOUS FLUX VS. JUNCTION TEMPERATURE - WHITE (ML-C PARALLEL:
 $I_F = 100\text{ mA}$, ML-C SERIES: $I_F = 50\text{ mA}$)**

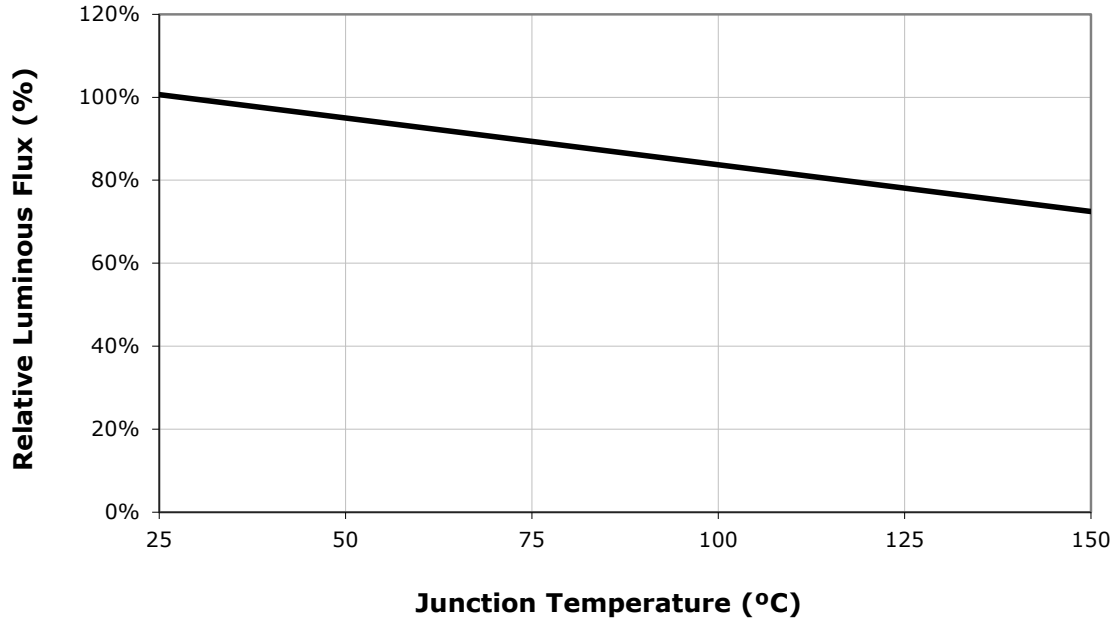

RELATIVE RADIANT FLUX VS. JUNCTION TEMPERATURE - ROYAL BLUE ($I_F = 100\text{ mA}$)

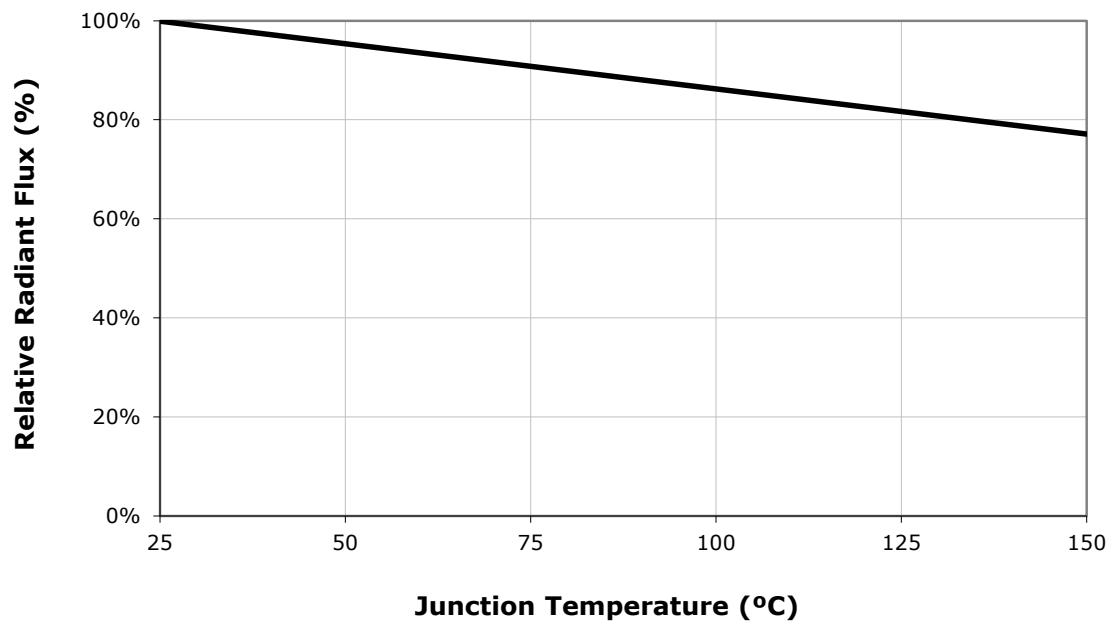

ELECTRICAL CHARACTERISTICS - ML-C PARALLEL WHITE ($T_j = 25\text{ }^\circ\text{C}$)

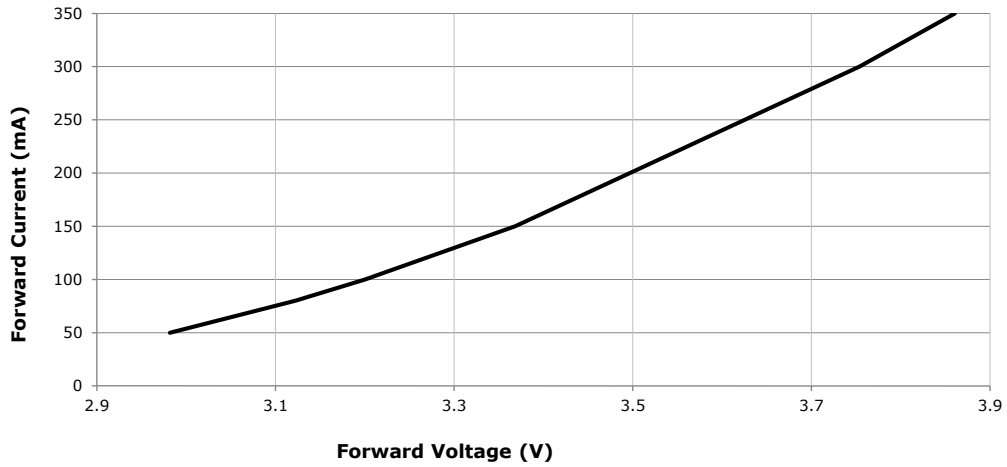

ELECTRICAL CHARACTERISTICS - ML-C SERIES WHITE ($T_j = 25\text{ }^\circ\text{C}$)

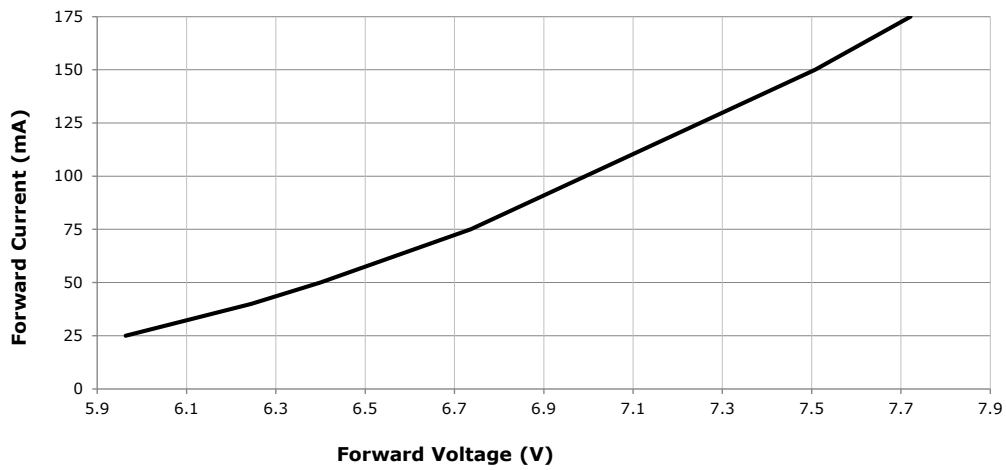

ELECTRICAL CHARACTERISTICS - ROYAL BLUE ($T_j = 25\text{ }^\circ\text{C}$)

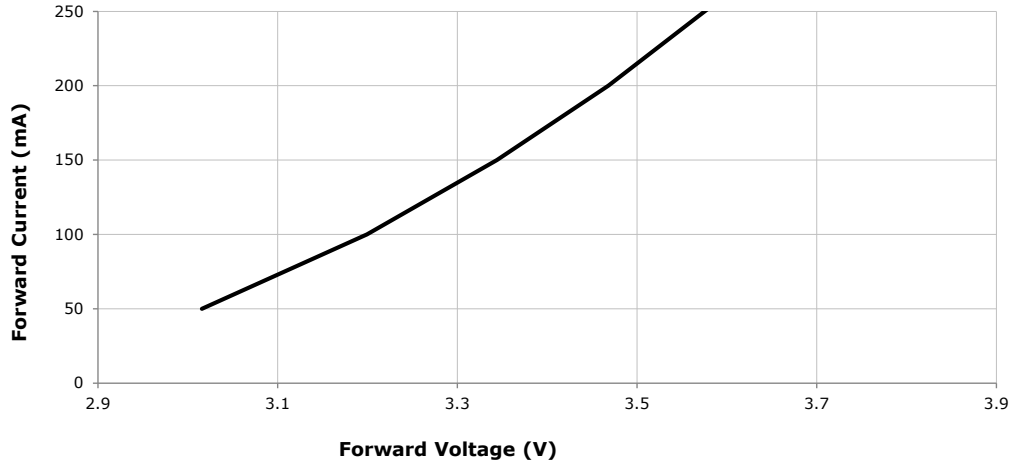

RELATIVE LUMINOUS FLUX VS. CURRENT - ML-C PARALLEL WHITE ($T_j = 25\text{ }^\circ\text{C}$)

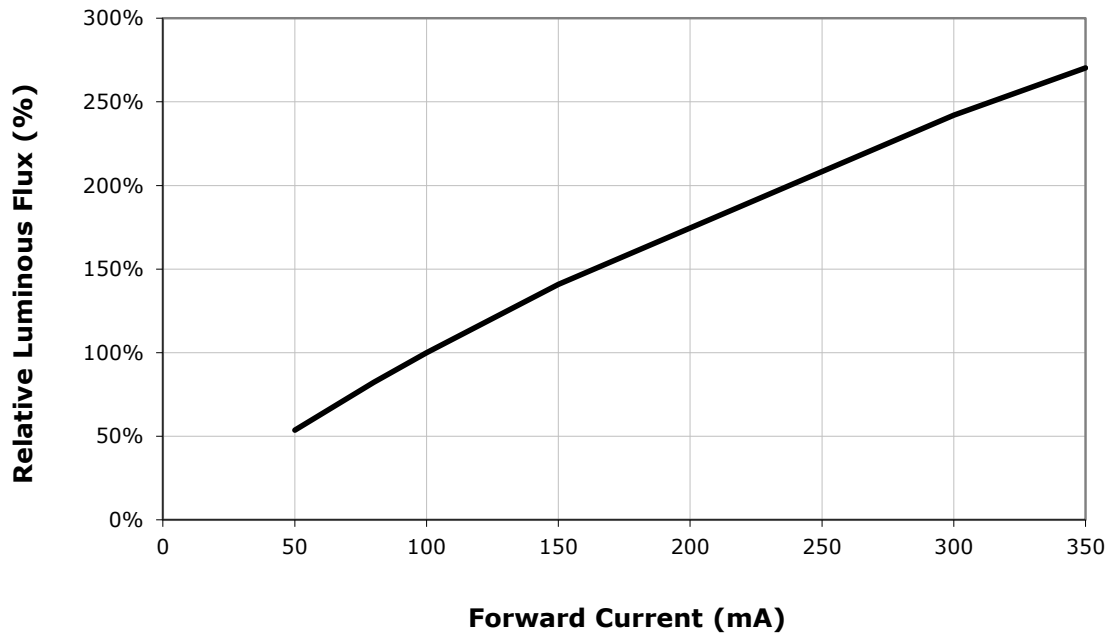

RELATIVE LUMINOUS FLUX VS. CURRENT - ML-C SERIES WHITE ($T_j = 25\text{ }^\circ\text{C}$)

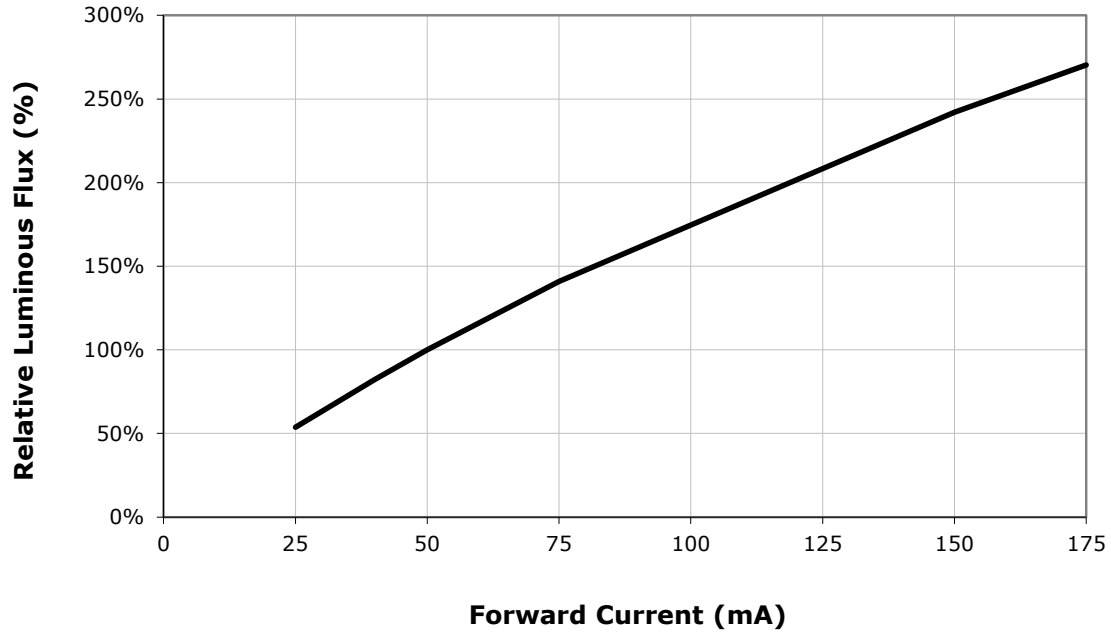

RELATIVE RADIANT FLUX VS. CURRENT - ROYAL BLUE ($T_j = 25\text{ }^\circ\text{C}$)

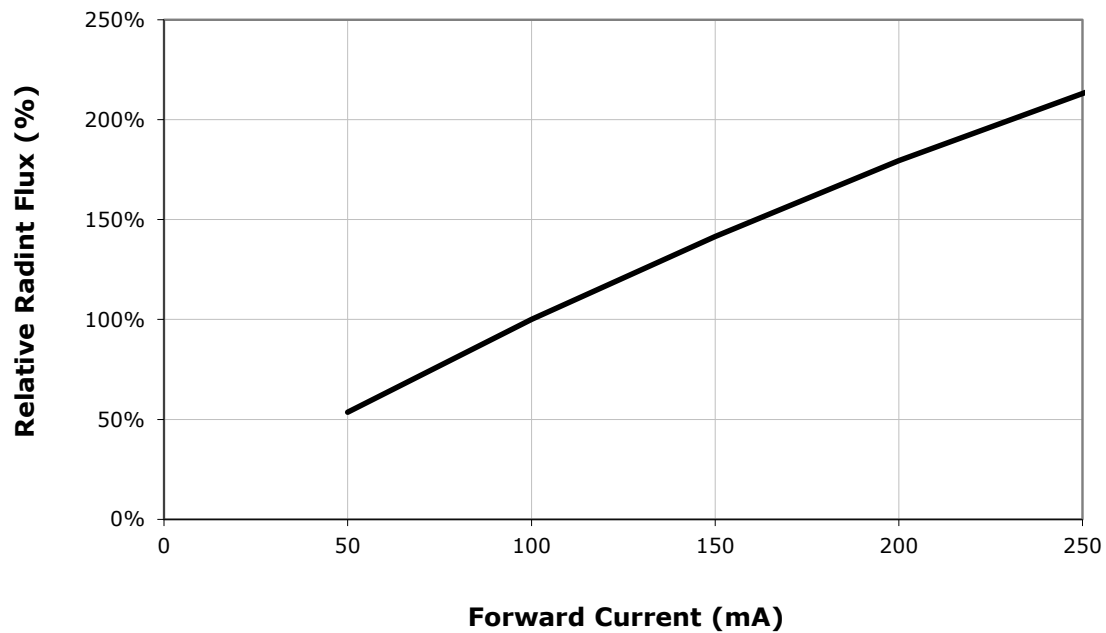

TYPICAL SPATIAL DISTRIBUTION - WHITE

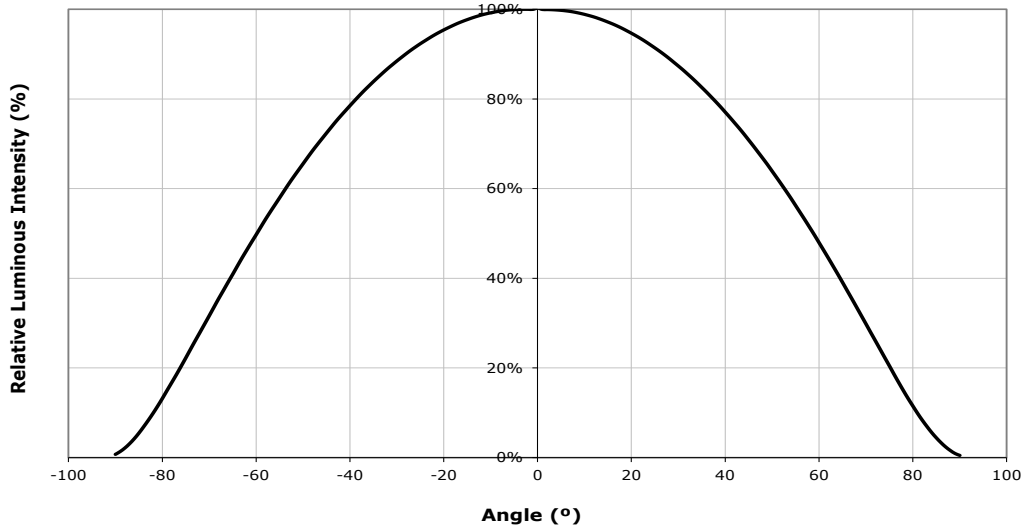

TYPICAL SPATIAL DISTRIBUTION - ROYAL BLUE

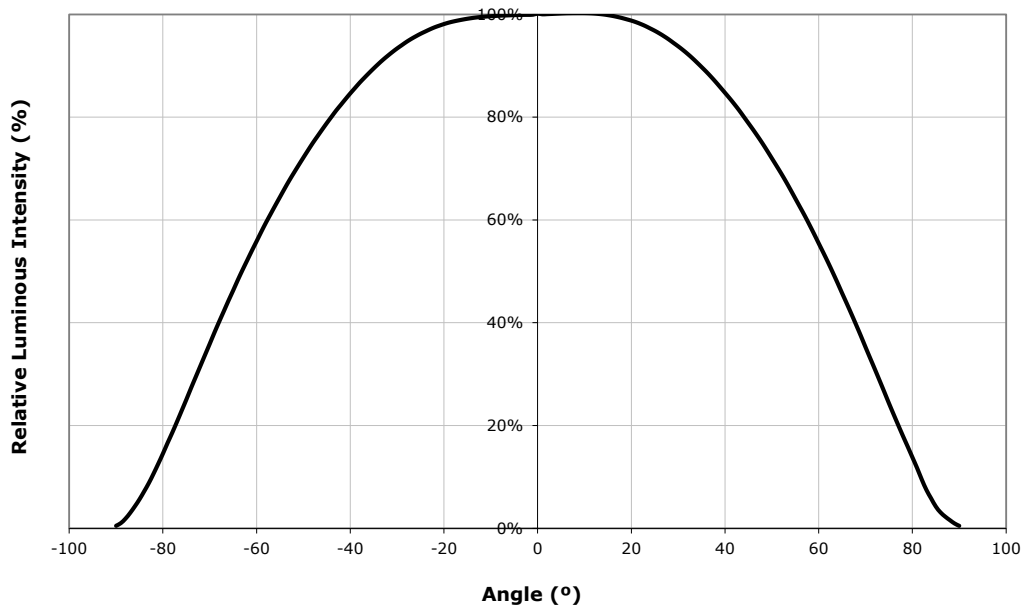

THERMAL DESIGN - ML-C PARALLEL WHITE

The maximum forward current is determined by the thermal resistance between the LED junction and ambient. It is crucial for the end product to be designed in a manner that minimizes the thermal resistance from the solder point to ambient in order to optimize lamp life and optical characteristics.

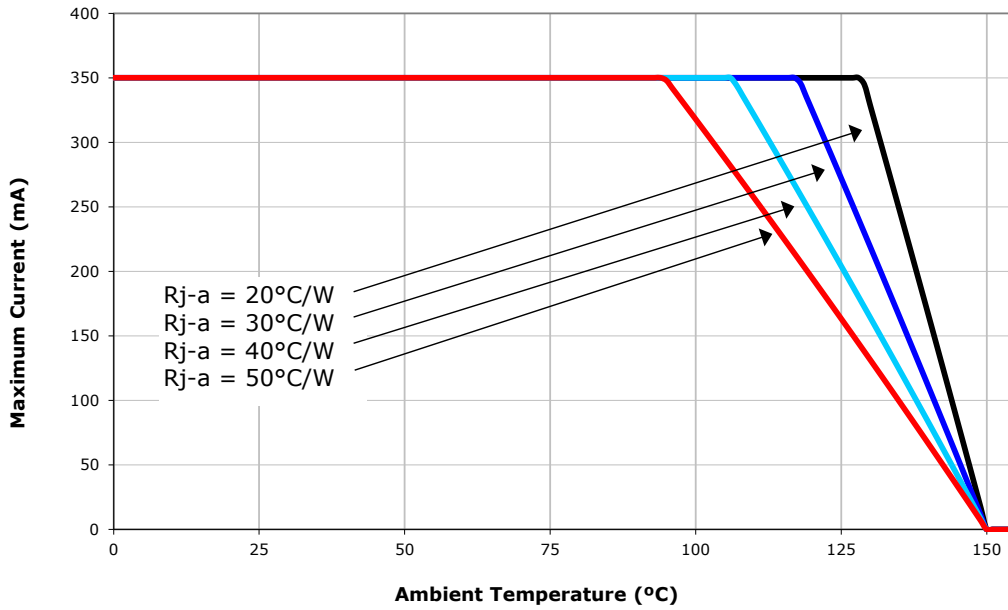

THERMAL DESIGN - ML-C SERIES WHITE

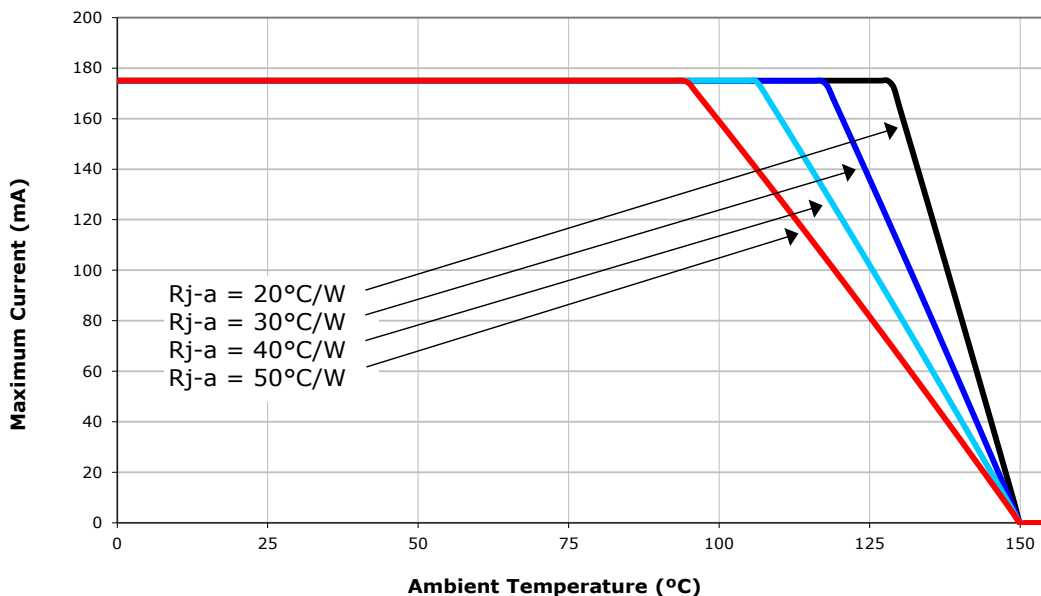

THERMAL DESIGN - ROYAL BLUE

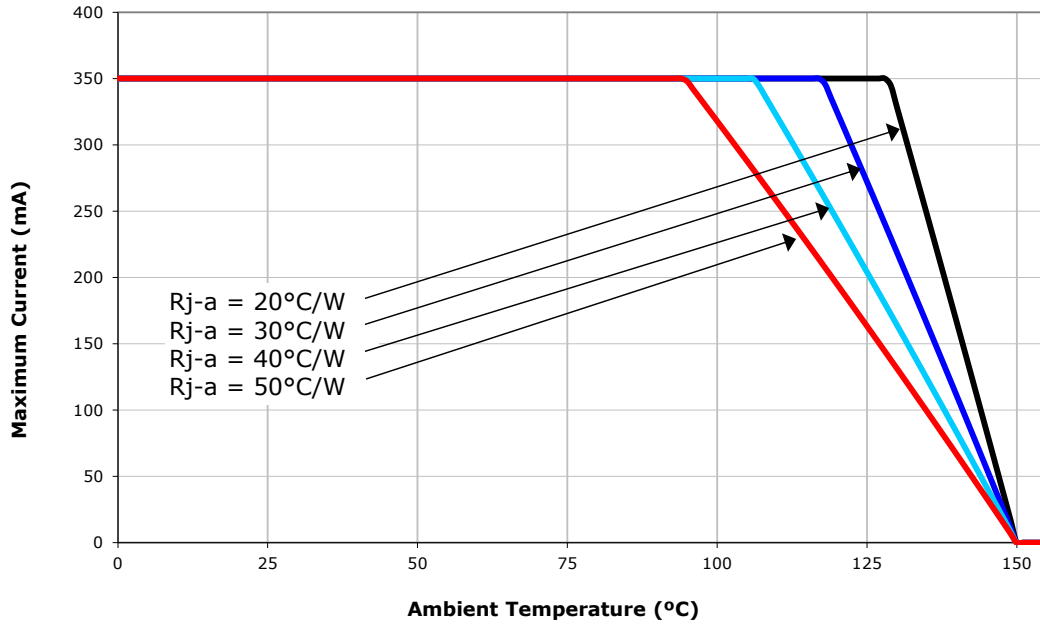

REFLOW SOLDERING CHARACTERISTICS

In testing, Cree has found XLamp ML-C LEDs to be compatible with JEDEC J-STD-020C, using the parameters listed below. As a general guideline, Cree recommends that users follow the recommended soldering profile provided by the manufacturer of solder paste used.

Note that this general guideline may not apply to all PCB designs and configurations of reflow soldering equipment.

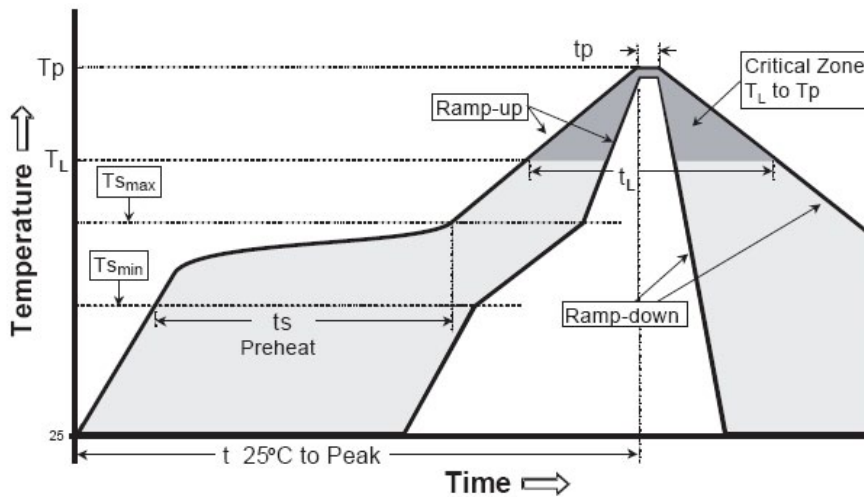

IPC/JEDEC J-STD-020C

| Profile Feature | Lead-Based Solder | Lead-Free Solder |
|-------------------------------------------------------|-------------------|------------------|
| Average Ramp-Up Rate ($T_{s_{max}}$ to T_p) | 3 °C/second max. | 3 °C/second max. |
| Preheat: Temperature Min ($T_{s_{min}}$) | 100 °C | 150 °C |
| Preheat: Temperature Max ($T_{s_{max}}$) | 150 °C | 200 °C |
| Preheat: Time ($t_{s_{min}}$ to $t_{s_{max}}$) | 60-120 seconds | 60-180 seconds |
| Time Maintained Above: Temperature (T_l) | 183 °C | 217 °C |
| Time Maintained Above: Time (t_l) | 60-150 seconds | 60-150 seconds |
| Peak/Classification Temperature (T_p) | 215 °C | 260 °C |
| Time Within 5 °C of Actual Peak Temperature (t_p) | 10-30 seconds | 20-40 seconds |
| Ramp-Down Rate | 6 °C/second max. | 6 °C/second max. |
| Time 25 °C to Peak Temperature | 6 minutes max. | 8 minutes max. |

Note: All temperatures refer to topside of the package, measured on the package body surface.

Note: While the high reflow temperatures (above) have been approved, Cree’s best practice guideline for reflow is to use as low a temperature as possible during the reflow soldering process for these LEDs.

NOTES

Lumen Maintenance Projections

Cree now uses standardized IES LM-80-08 and TM-21-11 methods for collecting long-term data and extrapolating LED lumen maintenance. For information on the specific LM-80 data sets available for this LED, refer to the public LM-80 results document at www.cree.com/xlamp_app_notes/LM80_results.

Please read the XLamp Long-Term Lumen Maintenance application note at www.cree.com/xlamp_app_notes/lumen_maintenance for more details on Cree’s lumen maintenance testing and forecasting. Please read the XLamp Thermal Management application note at www.cree.com/xlamp_app_notes/thermal_management for details on how thermal design, ambient temperature, and drive current affect the LED junction temperature.

Moisture Sensitivity

XLamp ML-C LEDs are shipped in sealed, moisture-barrier bags (MBB) designed for long shelf life. If XLamp ML-C LEDs are exposed to moist environments after opening the MBB packaging but before soldering, damage to the LED may occur during the soldering operation. The derating table at right defines the maximum exposure time (in days) for an XLamp ML-C LED in the listed humidity and temperature conditions. LEDs with exposure time longer than the time specified below must be baked according to the baking conditions listed below.

| Temp. | Maximum Percent Relative Humidity | | | | | | |
|-------|-----------------------------------|-----|-----|-----|-----|-----|-----|
| | 30% | 40% | 50% | 60% | 70% | 80% | 90% |
| 35 °C | - | - | - | 17 | 1 | .5 | .5 |
| 30 °C | - | - | - | 28 | 1 | 1 | 1 |
| 25 °C | - | - | - | - | 2 | 1 | 1 |
| 20 °C | - | - | - | - | 2 | 1 | 1 |

Cree recommends keeping XLamp LEDs in their sealed moisture-barrier packaging until immediately prior to use. Cree also recommends returning any unused LEDs to the resealable moisture-barrier bag and closing the bag immediately after use.

Baking Conditions

It is not necessary to bake all XLamp ML-C LEDs. Only the LEDs that meet all of the following criteria must be baked:

1. LEDs that have been removed from the original MBB packaging.
2. LEDs that have been exposed to a humid environment longer than listed in the Moisture Sensitivity section above.
3. LEDs that have not been soldered.

LEDs should be baked at 70 °C for 24 hours. LEDs may be baked on the original reels. Remove LEDs from MBB packaging before baking. Do not bake parts at temperatures higher than 70 °C. This baking operation resets the exposure time as defined in the Moisture Sensitivity section above.

Storage Conditions

XLamp ML-C LEDs that have been removed from the original MBB packaging but not soldered should be stored in one of the following ways:

- Store the parts in a rigid metal container with a tight-fitting lid. Verify that the storage temperature is $<30\text{ }^{\circ}\text{C}$, and place fresh desiccant and an RH indicator in the container to verify that the RH is no greater than 60%.
- Store the parts in a dry, nitrogen-purged cabinet or container that actively maintains the temperature at $<30^{\circ}$ and the RH at no greater than 60%.
- For short-term store only: LEDs can be resealed in the original MBB bag soon after opening. Fresh desiccant may be needed. Use the included humidity indicator card to verify $<60\%$ RH.

If an environment of $<60\%$ RH is not available for storage, XLamp ML-C LEDs should be baked (described above) before reflow soldering.

RoHS Compliance

The levels of RoHS restricted materials in this product are below the maximum concentration values (also referred to as the threshold limits) permitted for such substances, or are used in an exempted application, in accordance with EU Directive 2011/65/EC (RoHS2), as implemented January 2, 2013. RoHS Declarations for this product can be obtained from your Cree representative or from the Product Documentation sections of www.cree.com.

Vision Advisory Claim

WARNING. Do not look at exposed LED lamps in operation. Eye injury can result. For more information about LEDs and eye safety, please refer to the Cree LED Eye Safety Application Note (www.cree.com/xlamp_app_notes/led_eye_safety).

MECHANICAL DIMENSIONS (T_A = 25 °C)

All measurements are ±.13 mm unless otherwise indicated.

Top View

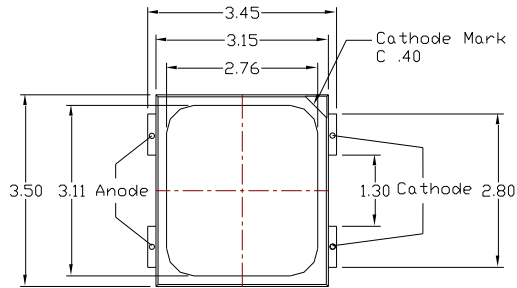
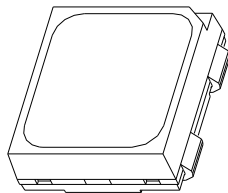

Top View

Bottom View

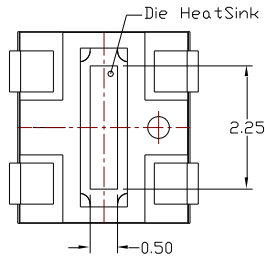

Side View

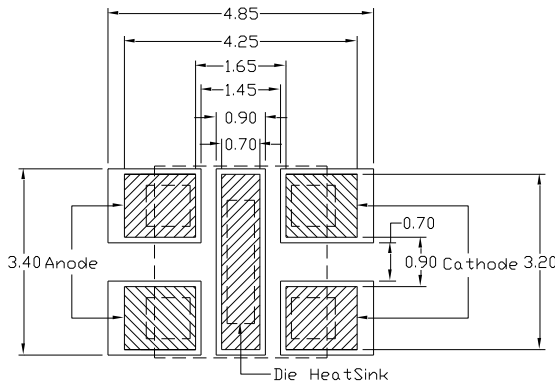
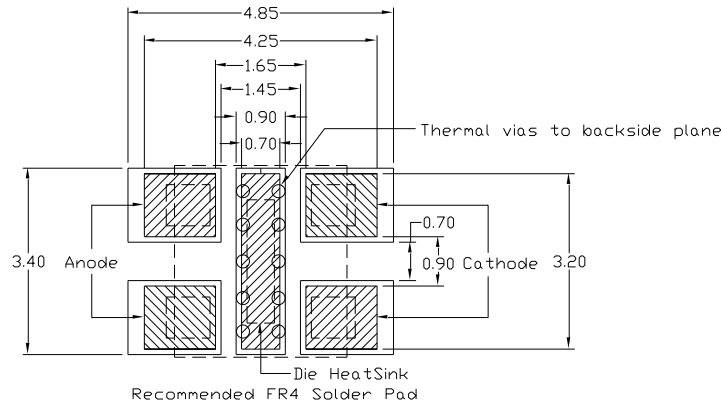
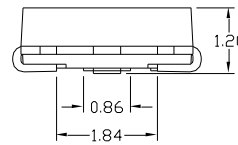

Recommended MCPCB Solder Pad

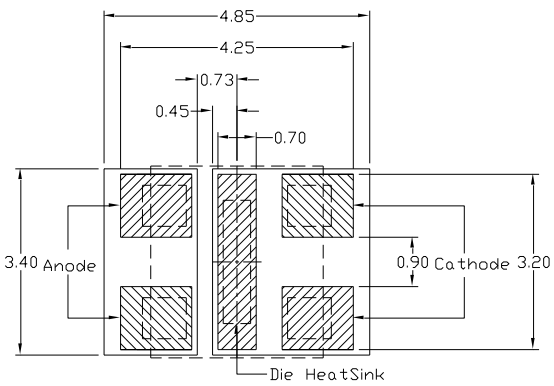

Alternative Solder Pad

TAPE AND REEL

All Cree carrier tapes conform to EIA-481D, Automated Component Handling Systems Standard.

All dimensions in mm.

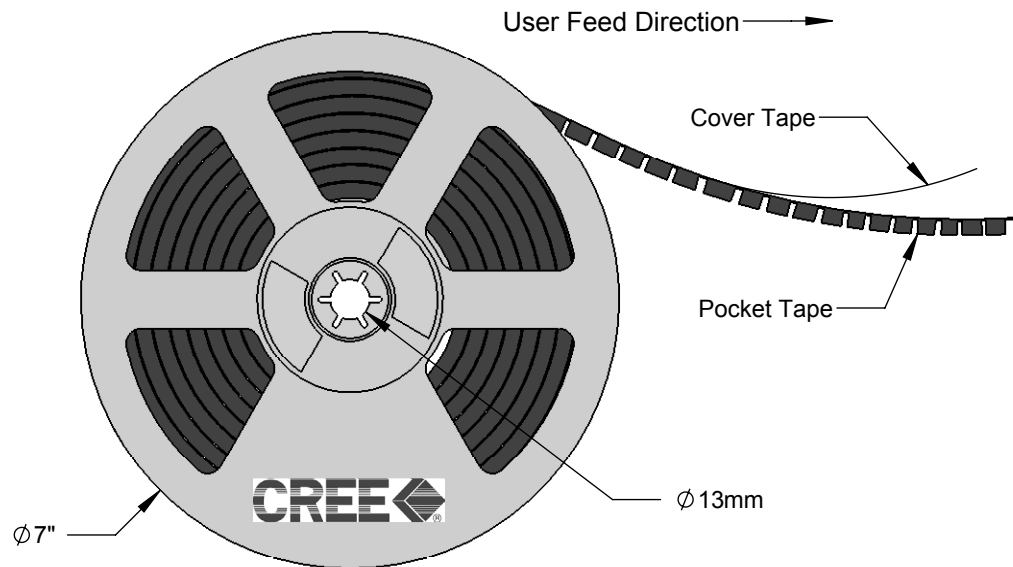
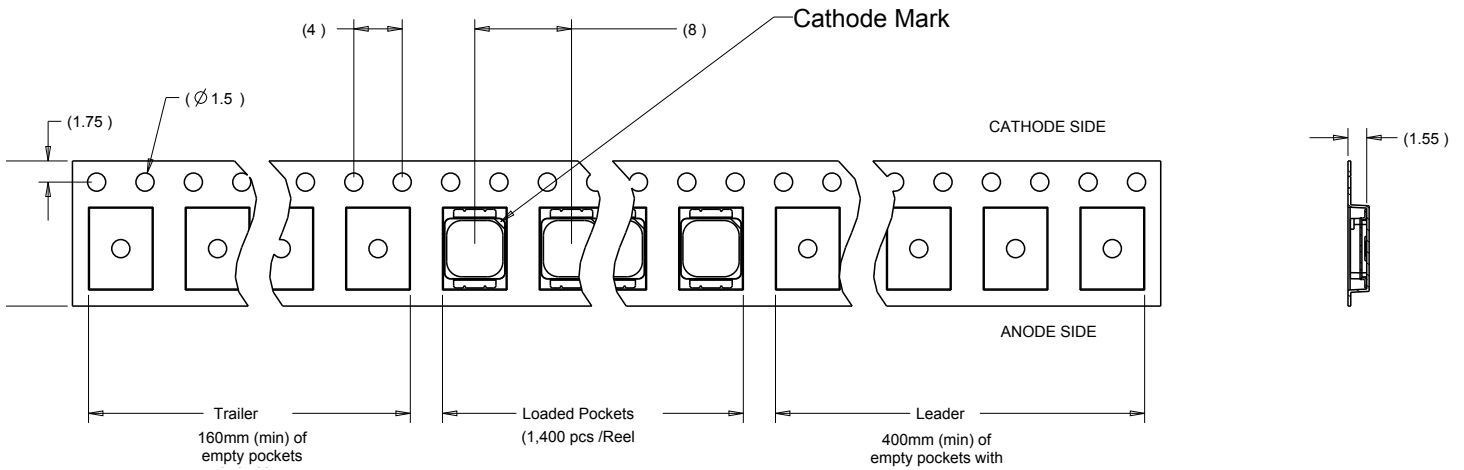

PACKAGING

Unpackaged Reel

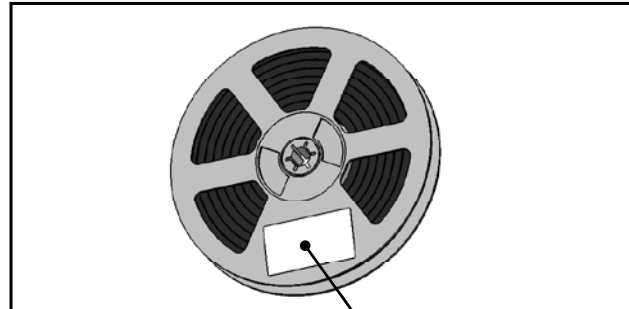

Label with Cree Bin Code, Qty, Reel ID

Packaged Reel

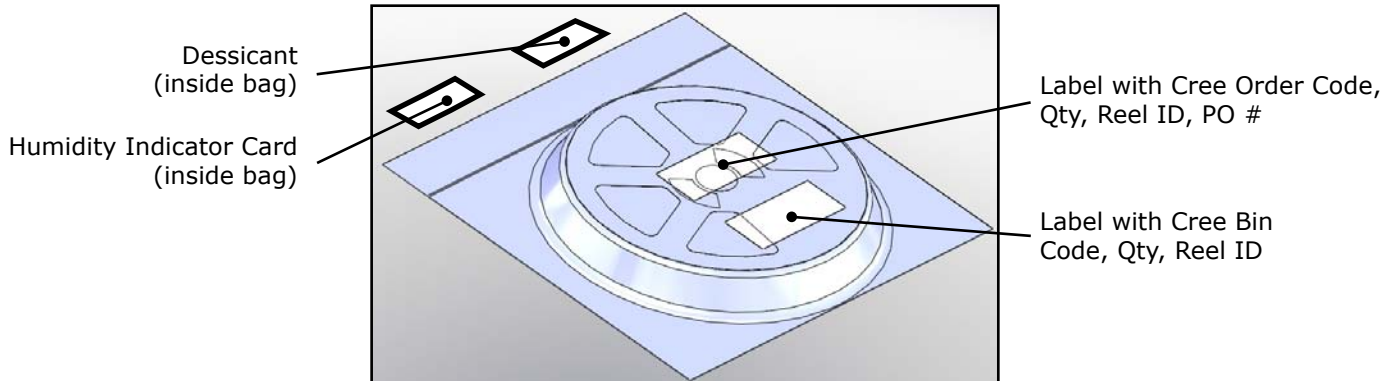

Dessicant (inside bag)

Humidity Indicator Card (inside bag)

Label with Cree Order Code, Qty, Reel ID, PO #

Label with Cree Bin Code, Qty, Reel ID

Boxed Reel

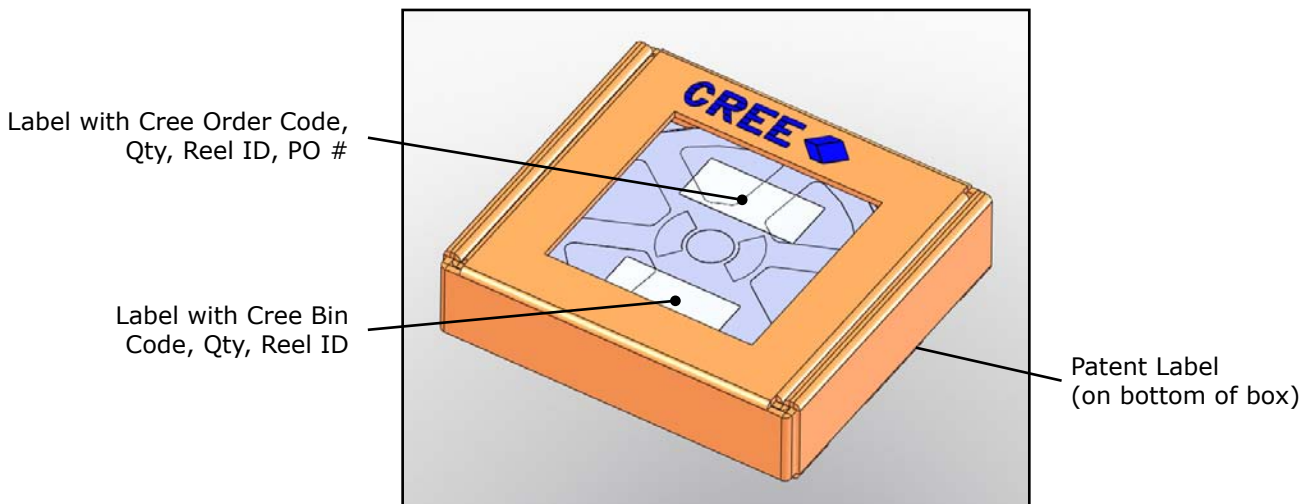

Label with Cree Order Code, Qty, Reel ID, PO #

Label with Cree Bin Code, Qty, Reel ID

Patent Label (on bottom of box)