

Safety isolating transformer **ACT 63**



Advantages

Integrated short circuit and overload protection thanks to temperature fuse in the input and fuse in the output (ACT 10 only temperature fuse)

Permanent corrosion protection, high insulation value and maximum electrical reliability thanks to XtraDensiFill resin encapsulation

Stable plastic housing for rail mounting, e.g. in consumer units or meter mounting boards

Applications

Safety isolating transformer for the safe electrical isolation of the input and output sides. The transformer is suitable for creating SELV and PELV circuits because of the limit on the output voltage.

Standards



Safety isolating transformer
to: VDE 0570 Part 2-6, DIN EN 61558-2-6, EN 61558-2-6, IEC 61558-2-6

Approvals



Safety isolating transformer ACT 63

Electrical data	
Type	
ACT 63	
Input	
Rated input voltage	230 Vac
Rated frequency	50 - 60 Hz
Output	
Rated output voltage	24 Vac
Rated Power	63 VA
Environment	
Ambient temperature max.	25 °C
Cooling method	self cooling
Safety and protection	
Type	Resin encapsulated transformer
Class of Insulation System	B
Protection index	IP 00
Safety class (prepared)	II
Short circuit strength	non-inherently short-circuit proof
Test voltage	3750 Vac, 50 Hz
Order numbers	
Order Number	ACT 63

Mechanical data	
Type	
ACT 63	
Terminal and mounting	
Terminals	Screw-type terminal
Fixing method	Panel installation on mounting rails
Measures and weights	
Weight	1.93 kg

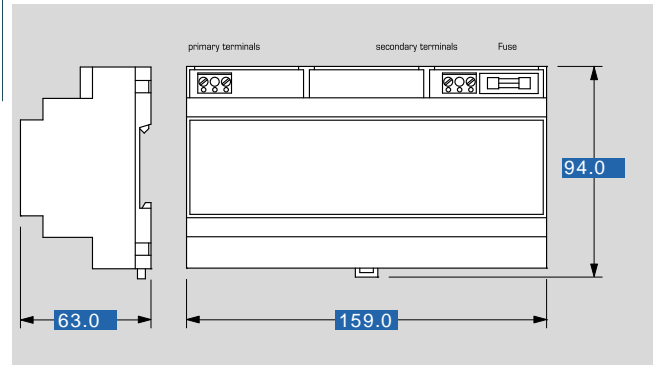

Subjects to change.