

Control- and safety isolating- resp. isolating transformer STEU 630/23



Advantages

Dual input voltage 230 and 400 Vac
Very good switch-on behaviour thanks to reduced starting currents
High performance for the volume thanks to compact design
Primary side ± 15 V tapplings for voltage adjustment
Very good corrosion protection and low noise thanks to BLOCKIMPEX vacuum impregnation
Quick to cable up thanks to the use of spring-loaded terminals
Contact protected screw connection terminals complying with UVV BGV A3
Simple mounting thanks to robust metal footplate with oval slots
Up to 250 VA with combination footplate for bolted and rail mounting

Applications

As a control transformer for the electrical isolation of the input and output sides. The construction of the transformer to supply control systems according to VDE 0113 is designed.

As an isolating transformer for the safe electrical isolation of the input and output sides. The transformer may be used to set up protective separation as a protective measure in accordance with VDE 0100.

As a safety transformer for the safe electrical isolation of the input and output sides. The transformer is suitable for creating SELV and PELV circuits because of the limit on the output voltage.

Standards



Control transformer
to: VDE 0570 Teil 2-2, DIN EN 61558-2-2, EN 61558-2-2, IEC 61558-2-2,
UL 5085-1/-2, CSA 22.2 No.66
Isolating transformer
to: VDE 0570 Part 2-4, DIN EN 61558-2-4, EN 61558-2-4, IEC 61558-2-4,
UL 5085-1/-2, CSA 22.2 No.66

Approvals



UL 5085-1/-2, CSA 22.2 No.66



Control- and safety isolating- resp. isolating transformer STEU 630/23

Type		STEU 630/23
Electrical data	Input	
	Rated input Voltage	230/400 Vac
	Tappings Input	±15 V
	Rated frequency	50 - 60 Hz
	Output	
	Rated output voltage	2 x 115 Vac
	Rated power VDE (DB cos phi=1)	630 VA
	Rated power VDE (KB cos phi=0.5)	2350 VA
	No-load voltage (app. x factor)	1.04
	Efficiency	92 %
	Standards	
	Classification	Control- and isolating transformer
	Approvals	
	Approvals	cURus
	Environment	
	Ambient temperature max.	40 °C
	Cooling method	self cooling
	Safety and protection	
	Type	open type
	Class of Insulation System	VDE=B, UL=class 130
	Protection index	IP 00
	Safety class (prepared)	I
	Short circuit strength	non-short-circuit proof
	PRI Fusing recommendation by circuit breaker with tripping characteristic type 20 x I _{rated} related to set)	
	Setting range 230 ±15 Vac	2.50 - 4.00 A
Setting value 230 ±15 Vac	3.00 A	
Setting range 400 ±15 Vac	1.60 - 2.50 A	
Setting value 400 ±15 Vac	1.70 A	
Order numbers		
Order Number	STEU 630/23	

Type		STEU 630/23
Mechanical data	Terminal and mounting	
	Terminals	Spring terminal, PE 6.3 x 0.8
	Fixing method	Base plate
	Fixing screws	M6
	Measures and weights	
	Weight	7.90 kg

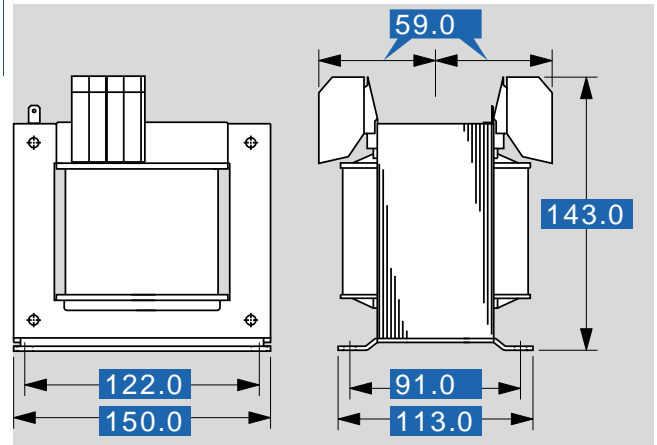

Subjects to change.