

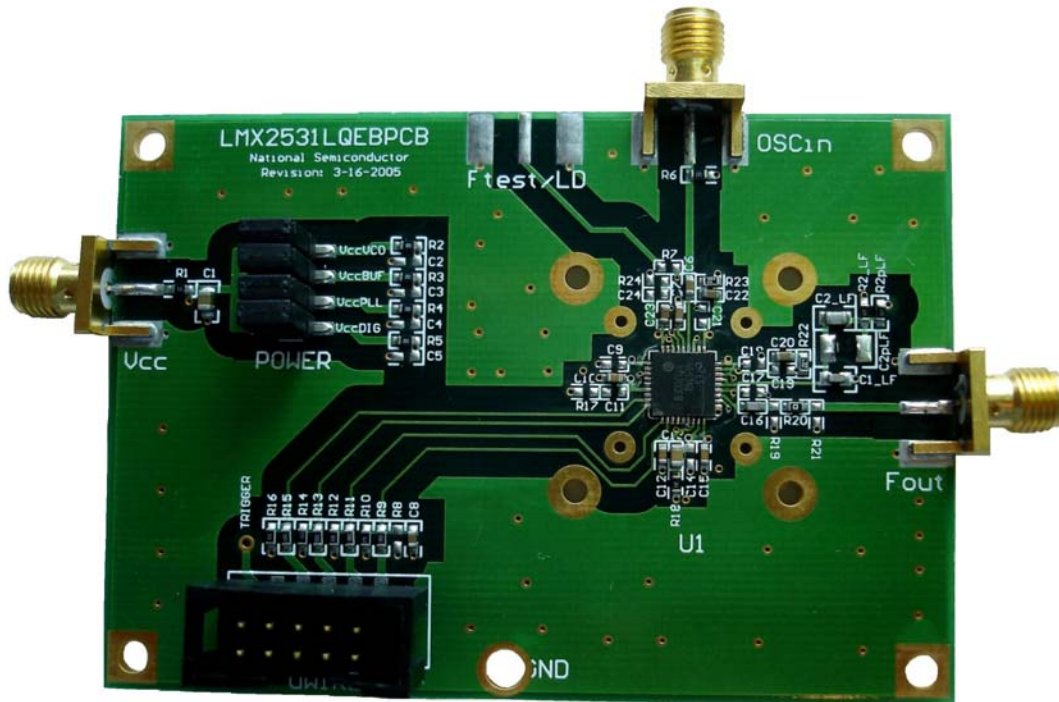

*National
Semiconductor*

LMX2531LQ1742 Evaluation Board Operating Instructions



**National Semiconductor Corporation
Wireless Communications, RF Products Group**

2900 Semiconductor Dr.
MS A2-600
Santa Clara, CA, 95052-8090

LMX2531LQ1742FPEB Rev 3.10.2006

TABLE OF CONTENTS

GENERAL DESCRIPTION	3
LOOP FILTER	3
PHASE NOISE	4
PHASE NOISE WITH NARROW LOOP FILTER (INTERNAL DIVIDE BY 2 DISABLED)	5
PHASE NOISE WITH NARROW LOOP FILTER (INTERNAL DIVIDE BY 2 ENABLED)	6
SPURS (INTERNAL DIVIDE BY 2 DISABLED).....	7
SPURS (INTERNAL DIVIDE BY 2 ENABLED)	8
CODELOADER SETTINGS	9
SCHEMATIC	11
TOP LAYER.....	13
MID LAYER 2 "POWER".....	15
BOTTOM LAYER "SIGNAL".....	16
TOP BUILD DIAGRAM.....	17

General Description

The LMX2531LQ1742 Evaluation Board simplifies evaluation of the LMX2531LQ1742 PLL/VCO synthesizer system. The board enables all performance measurements with no additional support circuitry. The evaluation board consists of a LMX2531LQ1742 device, and a cable assembly.

The cable assembly is bundled with the evaluation board for connecting to a PC through the parallel printer port. By means of **MICROWIRE™** serial port emulation, the *CodeLoader* software included can be run on a PC to facilitate the LMX2531LQ1742 internal register programming for the evaluation and measurement. In addition to this cable assembly, there is a microwire buffer board that ensures that the proper voltage levels are provided to the microwire inputs and also this reduces digital noise from computers through the parallel port.

Loop Filter			
Phase Margin	42.4 deg	K ϕ	90 uA
Loop Bandwidth	4.3 kHz	F _{comp}	2.5 MHz
TCXO Frequency	10 MHz	Output Frequency	1760 – 1866 MHz (DIV2=0) 880 – 933 MHz (DIV2=1)
Supply Voltage	3.0 Volts	VCO Gain	5.5 MHz/Volt

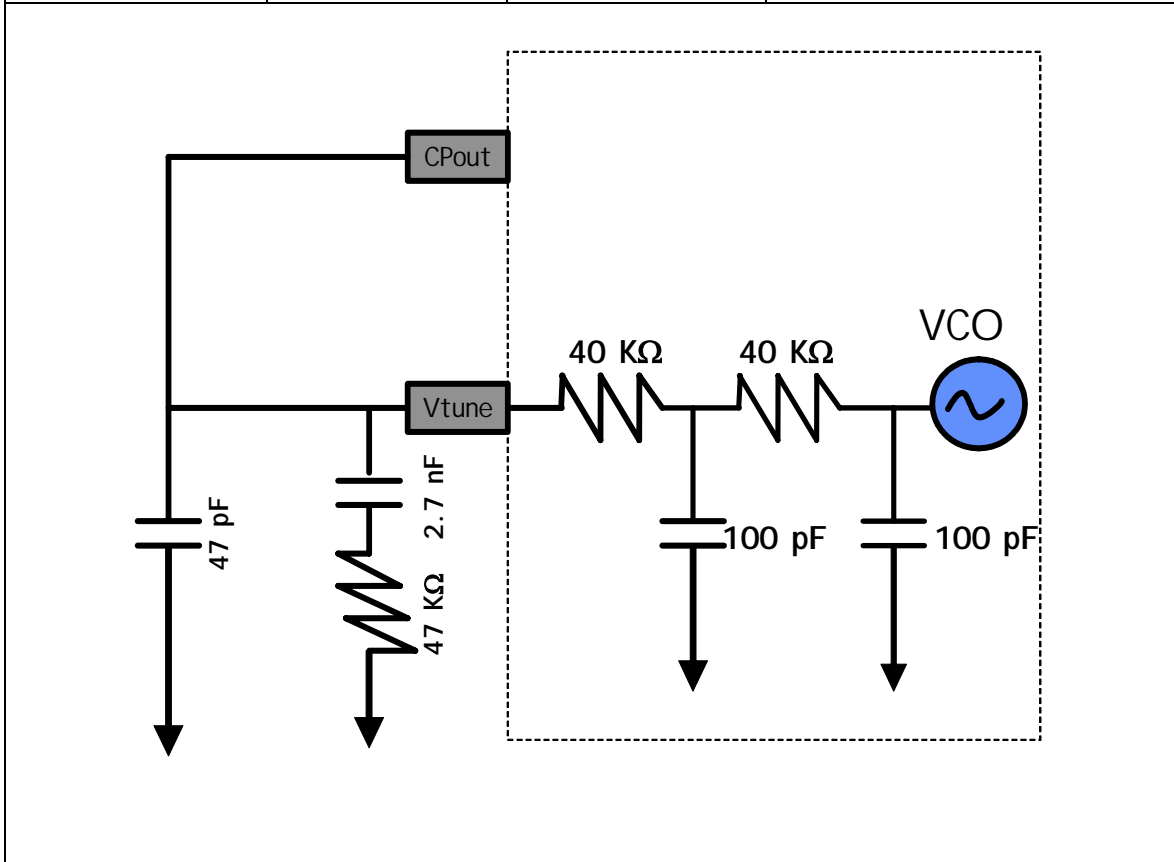

Phase Noise

Output Frequency = 1813 MHz
Internal Divide by 2 Disabled (DIV2=0)

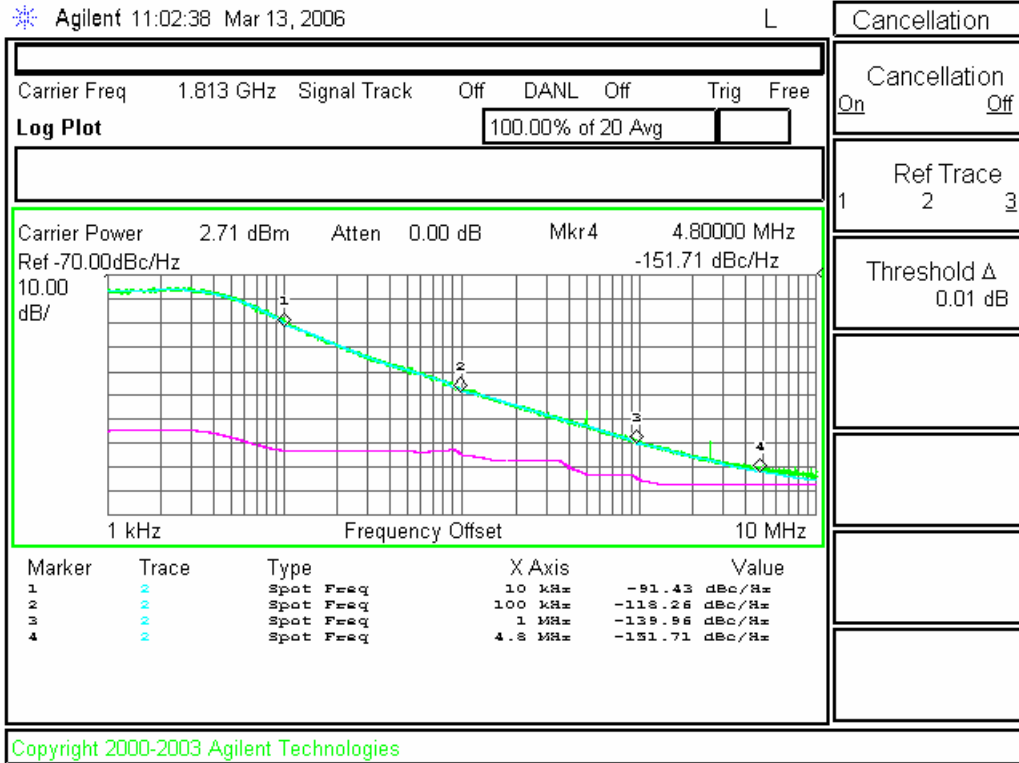

Output Frequency = 906.5 MHz
Internal Divide by 2 Enabled (DIV2=1)

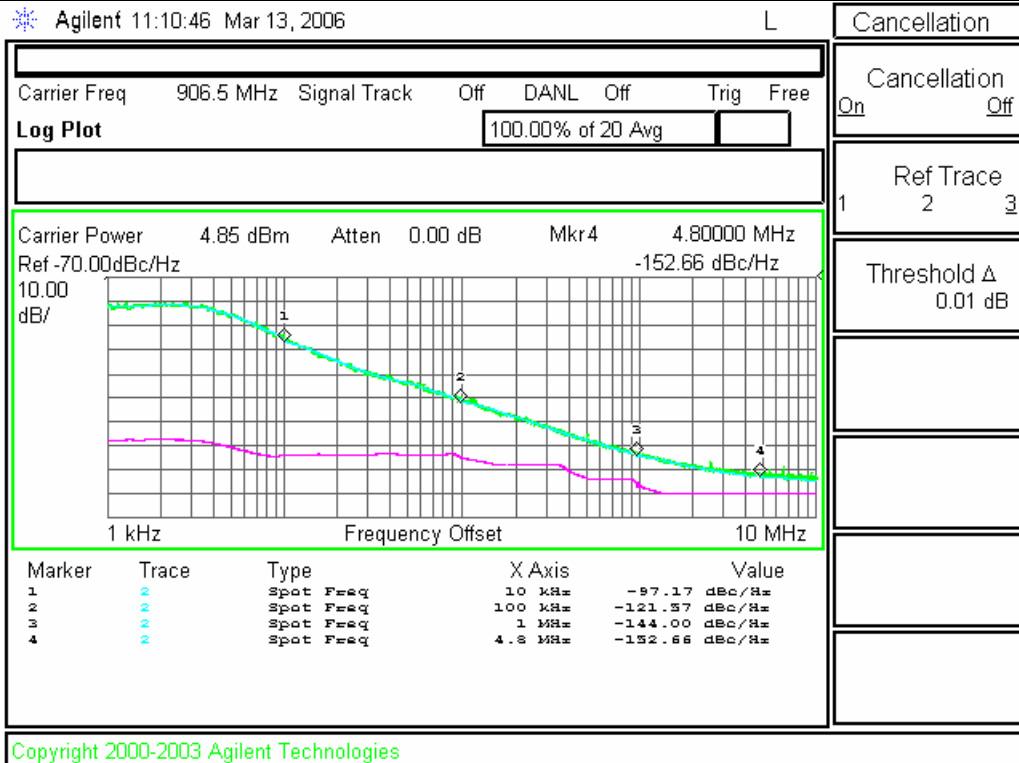

Phase Noise with Narrow Loop Filter (Internal Divide by 2 Disabled)

Fout = 1760 MHz

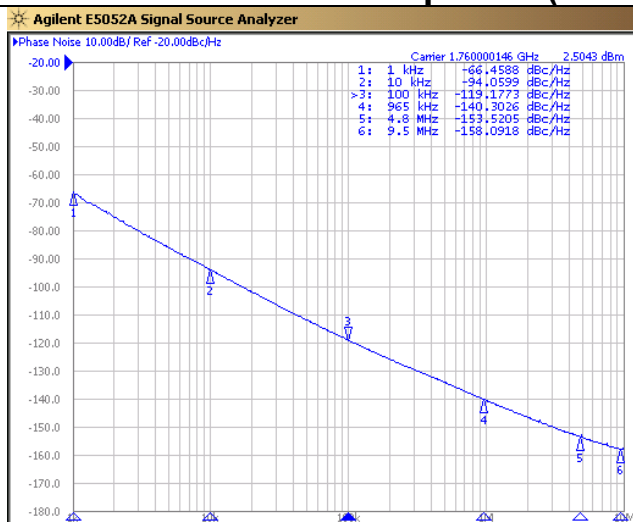

Fout = 1813 MHz

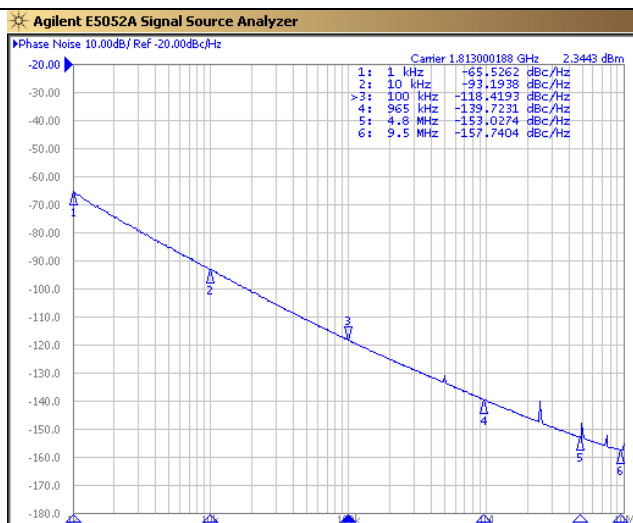

Fout = 1866 MHz

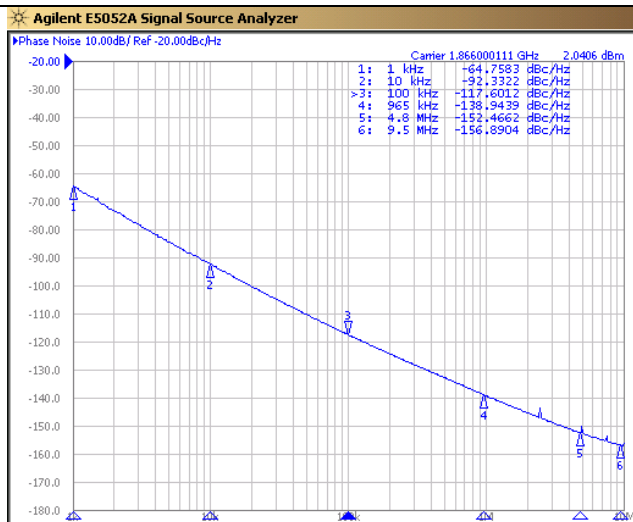

The plots to the left show the true phase noise capability of the VCO. In order to take these plots, a 20 Hz loop bandwidth was used with the E5052 spectrum analyzer. This is the most accurate and state of the art equipment.

At lower offsets, the measurements are more accurate because the impact of the PLL is removed. At higher offsets, the measurements are also more accurate because the E5052 spectrum analyzer has a much lower noise floor than the E4445A spectrum analyzer. Even though the E4445A has a noise cancellation feature, it only cancels out the thermal noise. It does not cancel out the phase noise of the LO inside the E4445A.

Phase Noise with Narrow Loop Filter (Internal Divide by 2 Enabled)

Fout = 880 MHz

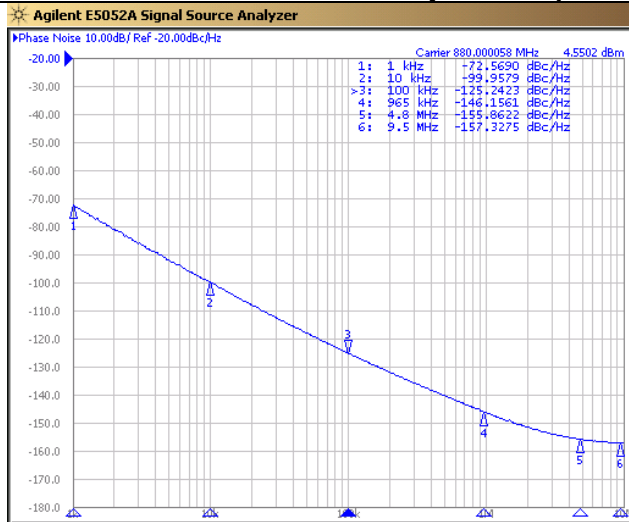

Fout = 906.5 MHz

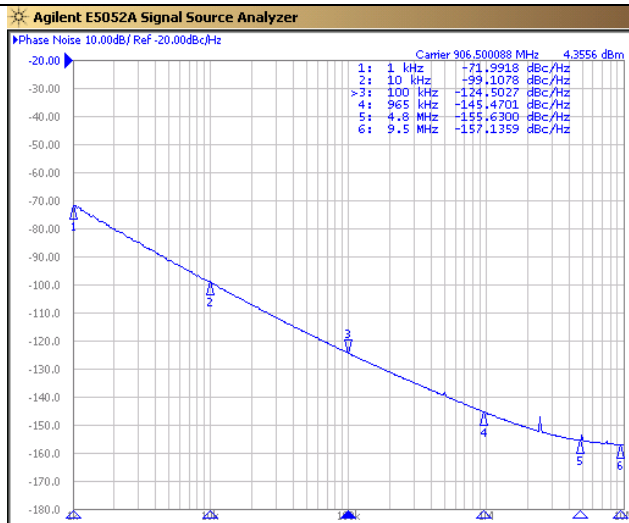

Fout = 933 MHz

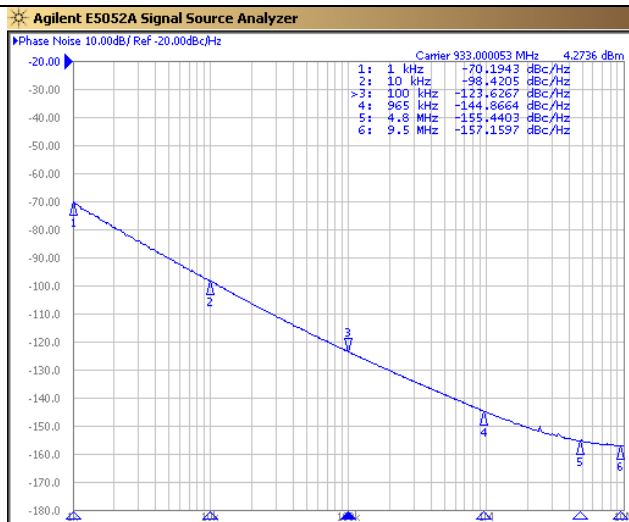

The plots to the left show the true phase noise capability of the VCO. In order to take these plots, a 20 Hz loop bandwidth was used with the E5052 spectrum analyzer. This is the most accurate and state of the art equipment.

At lower offsets, the measurements are more accurate because the impact of the PLL is removed. At higher offsets, the measurements are also more accurate because the E5052 spectrum analyzer has a much lower noise floor than the E4445A spectrum analyzer. Even though the E4445A has a noise cancellation feature, it only cancels out the thermal noise. It does not cancel out the phase noise of the LO inside the E4445A.

Spurs (Internal Divide by 2 Disabled)

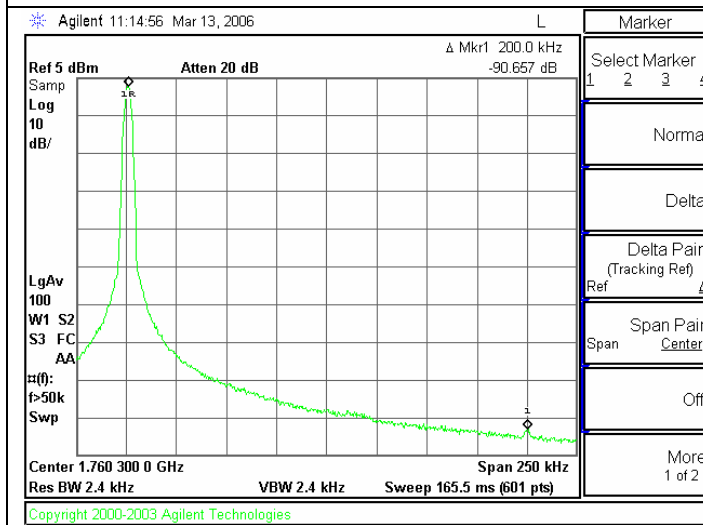

Spur at 200 kHz offset at a worst case frequency of 1760.2 MHz is -90.6 dBc. Worst case channels occur at exactly one channel spacing above or below a multiple of the crystal frequency.

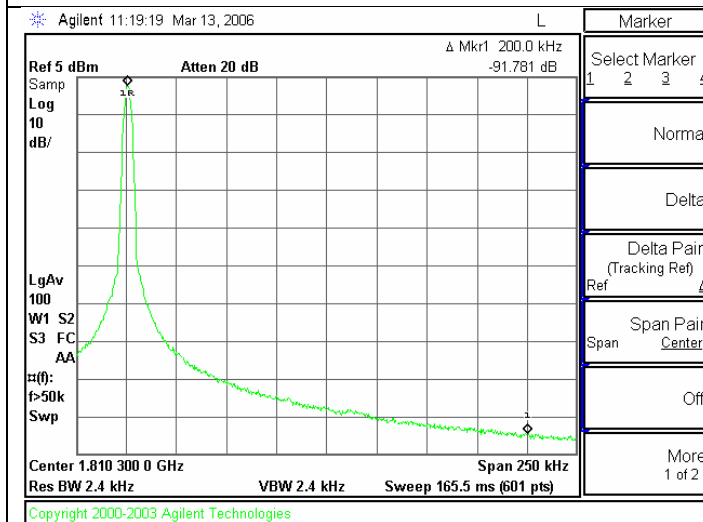

Spur at 200 kHz offset at a worst case frequency of 1810.2 MHz is -91.7 dBc.

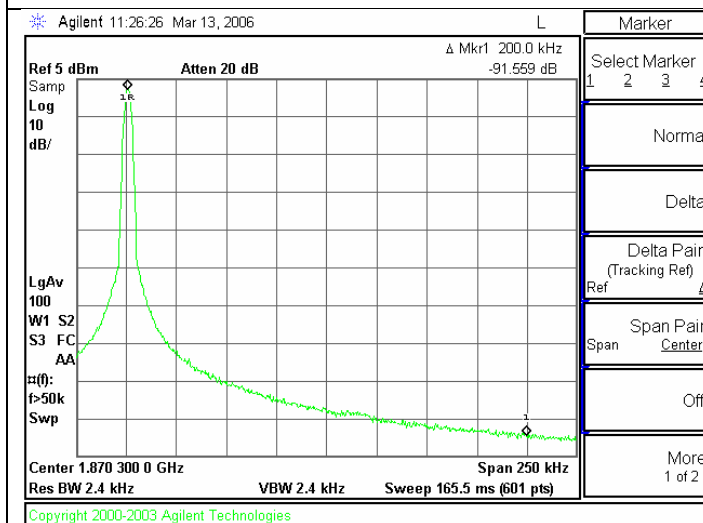

Spur at 200 kHz offset at a worst case frequency of 1870.2 MHz is -91.5 dBc.

Spurs (Internal Divide by 2 Enabled)

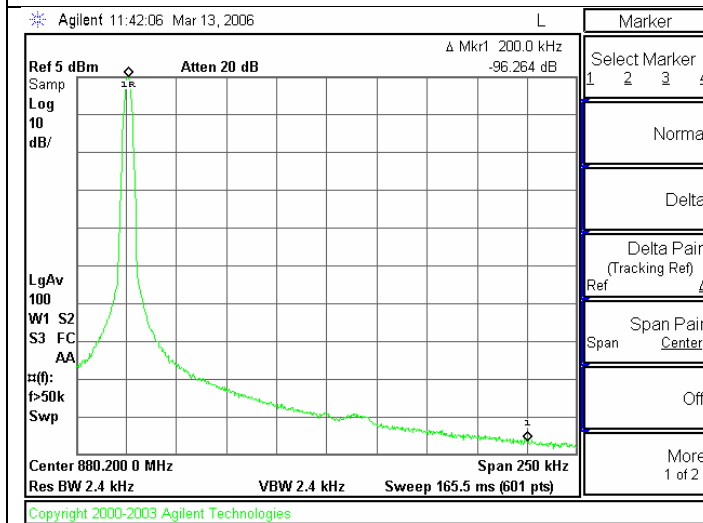

Spur at 200 kHz offset at a frequency of 880.1 MHz is -96.2 dBc. Since this mode uses the divide by 2 mode, the channel spacing here is actually 100 kHz. The spur at 100 kHz could be eliminated by doubling the channel spacing before the divider. The reason that the spur at 200 kHz is shown is to illustrate the theoretical 6 dB impact of the divider.

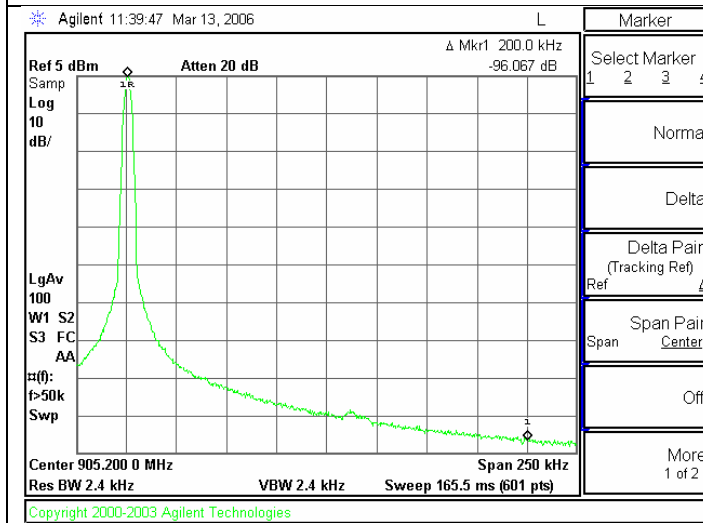

Spur at 200 kHz offset for a frequency of 905.1 MHz is better than -96.0 dBc.

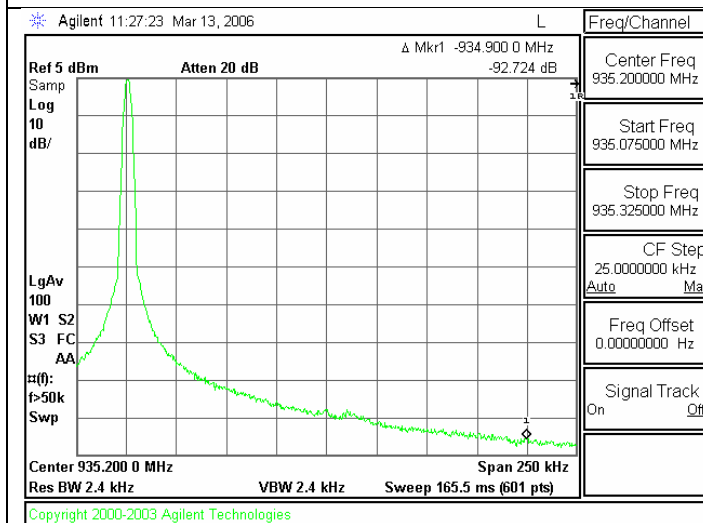

Spur at 200 kHz offset for a frequency of 935.1 MHz is better than -92.7 dBc.

CodeLoader Settings

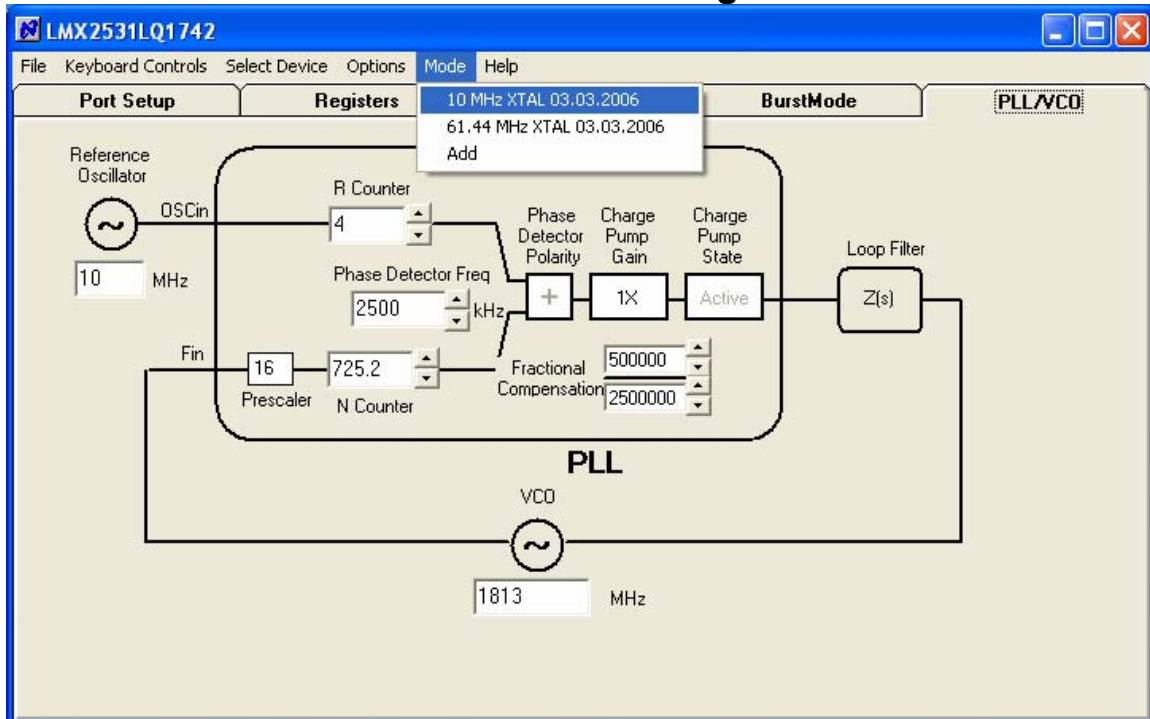

For the CodeLoader program, the default reference oscillator used for these instructions was 10 MHz, but there is a mode for a 61.44 MHz oscillator as well. If the bits become scrambled, their original state may be recalled by choosing the appropriate mode. Note that if the internal divide by 2 is enabled, the VCO frequency still reflects the VCO frequency before the divide by 2.

The screenshot shows the CodeLoader software interface for the LMX2531LQ1742. The 'PLL/VCO' tab is selected, displaying various control parameters:

- INITIALIZATION:** REG_RST (unchecked)
- VCO OUTPUT:** DIV2 (unchecked)
- POWER CONTROLS:** EN_PLL (checked), EN_PLLLD01 (checked), EN_PLLLD02 (checked), EN_DIGLDO (checked), EN_VCO (checked), EN_VCOLDO (checked), EN_OSC (checked)
- VCO PN OPTIMIZATION:** VCO_ACISEL (8)
- VCO FREQUENCY CAL:** XTLDIV (Divide by 2), XTLSSEL (<20 MHz), XTLMAN (0), XTLMAN2 (unchecked)
- FRACTIONAL CONTROLS:** FDM (checked), ORDER (3rd Order Modulator), DITHER (Strong Dithering)
- INTERNAL LOOP FILTER:** EN_LPFLTR (checked), C3_4_ADJ (C3=100pF, C4=100pF), R3_ADJ (40 Kohm), R4_ADJ (40 Kohm)
- FASTLOCK CONTROLS:** TOC (0), ICPFL (1X), R3_ADJ_FL (0 Ohm), R4_ADJ_FL (0 Ohm)
- LOCK DETECT:** LDDIV4 (unchecked), FoLD (Disabled)
- Program Pins:** CE (checked), TRIGGER (unchecked)

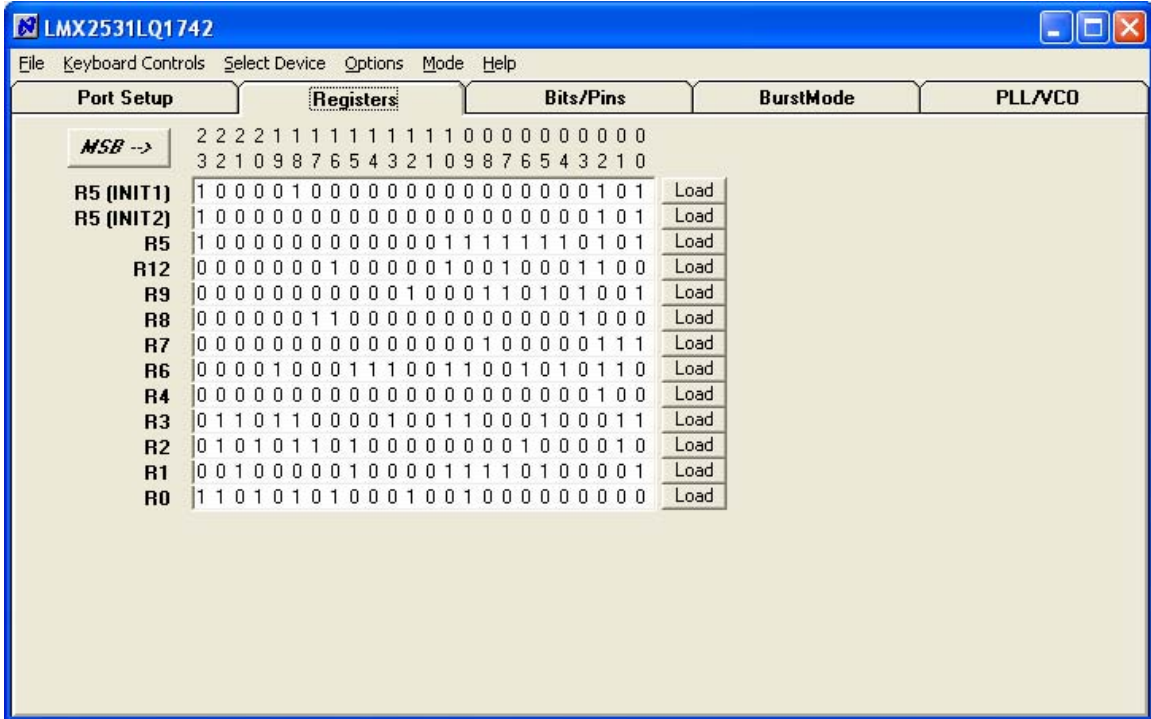

CodeLoader is set up to load the registers and initialize the part in the correct way. R5 (INIT1) and R5 (INIT 2) are just the R5 register being used to properly initialize the part. So a single CNT+L should load the part.

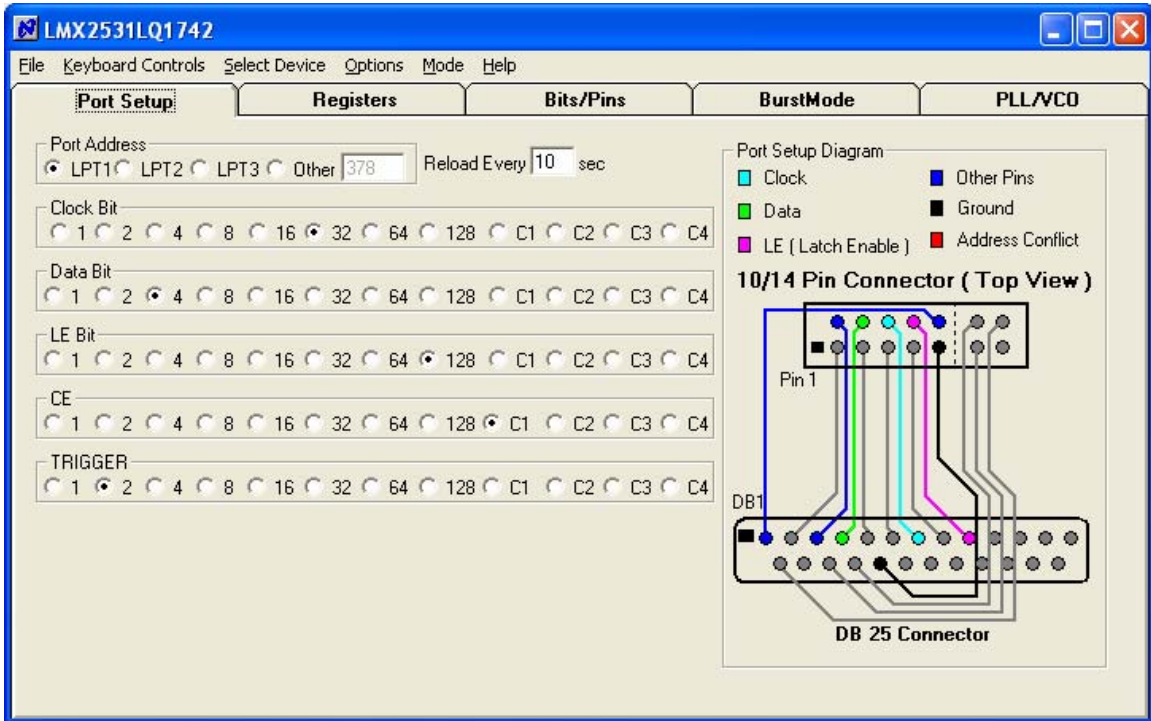

The port setup tells CodeLoader what information goes where. If this is wrong, the part will not program. Although LPT1 is usually correct, CodeLoader does not autodetect the correct port. On some laptops, it may be LPT3.

Schematic

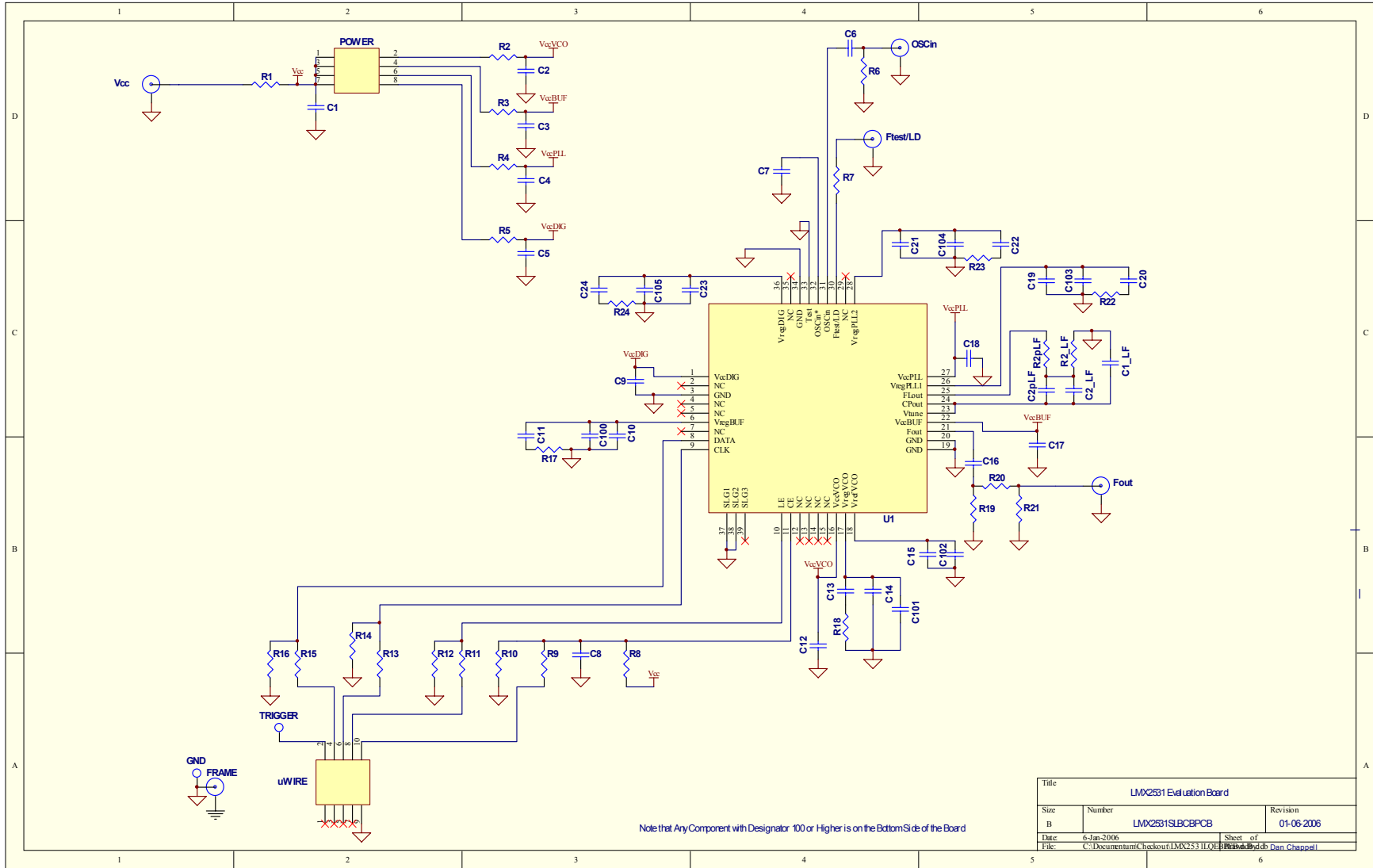

Bill of Materials				LMX2531EB				Revision 1/3/2006	
Item	QTY	Manufacturer	Part #	Size	Tol	Voltage	Material	Value	Designators
0	19	n/a						Open Capacitors	C2pLF, C2, C3, C4, C5, C9, C11, C14, C17, C18, C19, C21, C24, C100, C101, C102, C103, C104, C105
	6							Open Resistors	R7, R8, R17, R19, R21, R24
	1							Open Miscellaneous	Ftest/LD
1	1	Kemet	C0603C470J5GAC	603	5%	50V	C0G	47pF	C1_LF
2	1	Kemet	C0603C101J5GAC	603	5%	50V	C0G	100pF	C16
3	1	Kemet	C0805C272J3GAC	805	5%	25V	C0G	2.7nF	C2_LF
4	2	Kemet	C0603C103J5RAC	603	5%	50V	X7R	10nF	C10, C23
5	4	Kemet	C0603C104J3RAC	603	5%	25V	X7R	100nF	C6, C7, C12, C15
6	2	Kemet	C0603C474K4RAC	603	10%	16V	X7R	470nF	C20, C22
7	1	Kemet	C0603C105K4RAC	603	10%	16V	X5R	1uF	C8
8	1	Kemet	C0603C475K9PAC	603	10%	6.3V	X5R	4.7uF	C13
9	1	Kemet	C0805C106K8PAC	805	10%	10V	X5R	10uF	C1
10	1	Vishay	CRCW0603000ZRT1	603	5%	0.1W	Thick Film	0Ω	R20
11	2	Panasonic	P.22AHCT-ND	603	10%	0.1W	Thick Film	0.22Ω	R22, R23
12	2	Vishay	CRCW06033R3JRT1	603	5%	0.1W	Thick Film	3.3Ω	R1, R18
13	4	Vishay	CRCW0603100JRT1	603	5%	0.1W	Thick Film	10Ω	R2, R3, R4, R5
14	1	Vishay	CRCW0603510JRT1	603	5%	0.1W	Thick Film	51Ω	R6
15	4	Vishay	CRCW0603103JRT1	603	5%	0.1W	Thick Film	10KΩ	R9, R11, R13, R15
16	5	Vishay	CRCW0603123JRT1	603	5%	0.1W	Thick Film	12KΩ	R2pLF, R10, R12, R14, R16
17	1	Vishay	CRCW0603473JRT1	603	5%	0.1W	Thick Film	47KΩ	R2_LF
18	1	Comm Con Connectors	HTSM3203-8G2	2X4	n/a	n/a	Metal/Plastic	Header	POWER
19	1	FCI Electronics	52601-S10-8	2X5	n/a	n/a	Metal/Plastic	Header	uWire
20	3	Johnson Components	142-0701-851	SMA	n/a	n/a	Metal	SMA	Fout, OSCin, Vcc
21	1	National Semiconductor	LMX2531LQEBPCB	n/a	n/a	n/a	FR4 62 mil Thick	PCB Board 1st Layer 10 mils	n/a
22	1	National Semiconductor	LMX2531	LLP36	n/a	2.7	Silicon	LMX2531	U1
23	4	Com Con Connectors	CCIJ255G	2-Pin	n/a	n/a	Metal/Plastic	Shunt	Place Across: POWER: 1-2, 3-4, 5-6, 7-8
24	4	SPC Technology	SPCS-8	0.156"	n/a	n/a	Nylon	Nylon Standoffs	Place in 4 Holes in Corners of Board

Top Layer

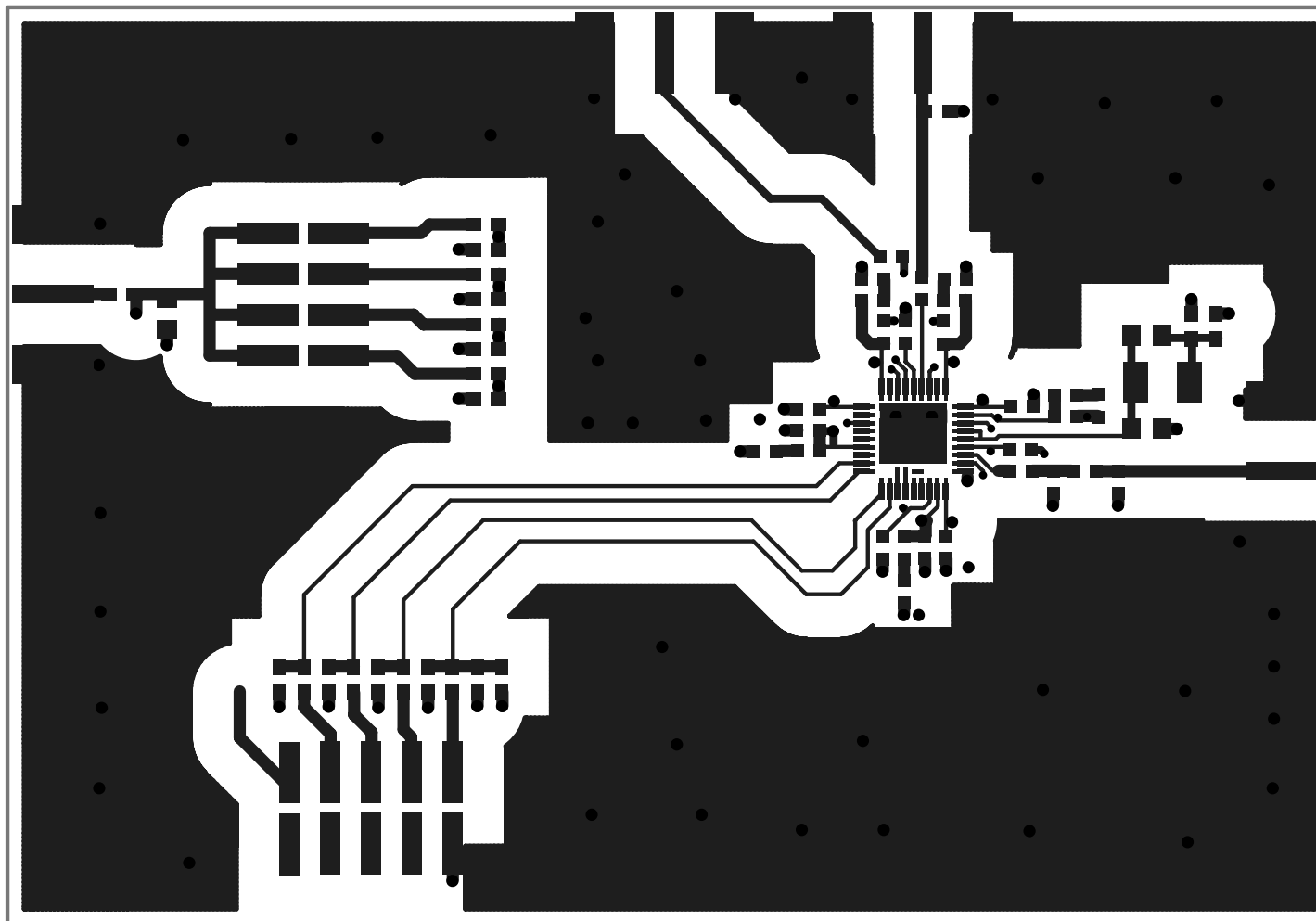

Mid Layer 1 "Ground Plane" (15 Mils Down FR4)

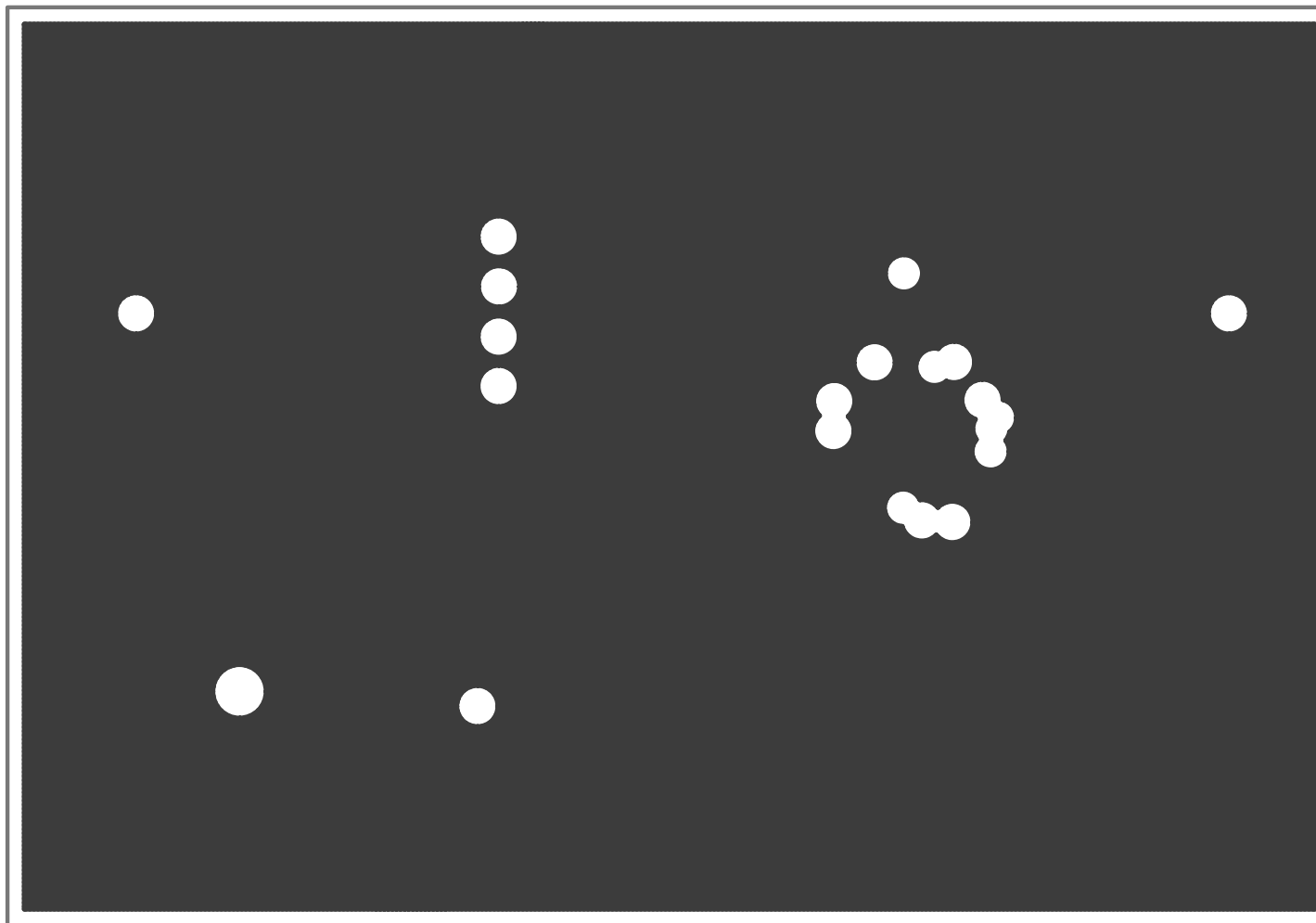

Mid Layer 2 "Power"

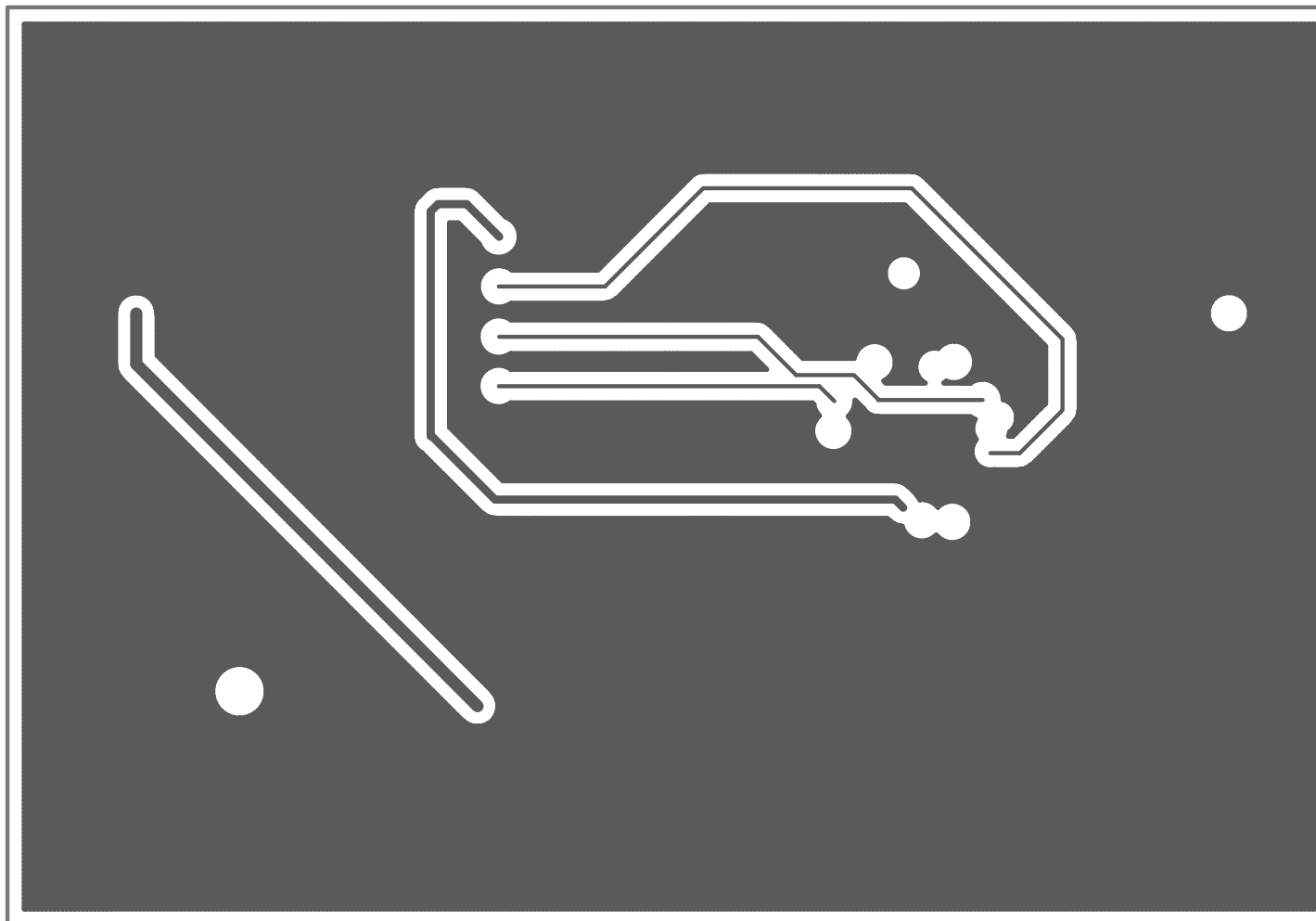

Bottom Layer "Signal"

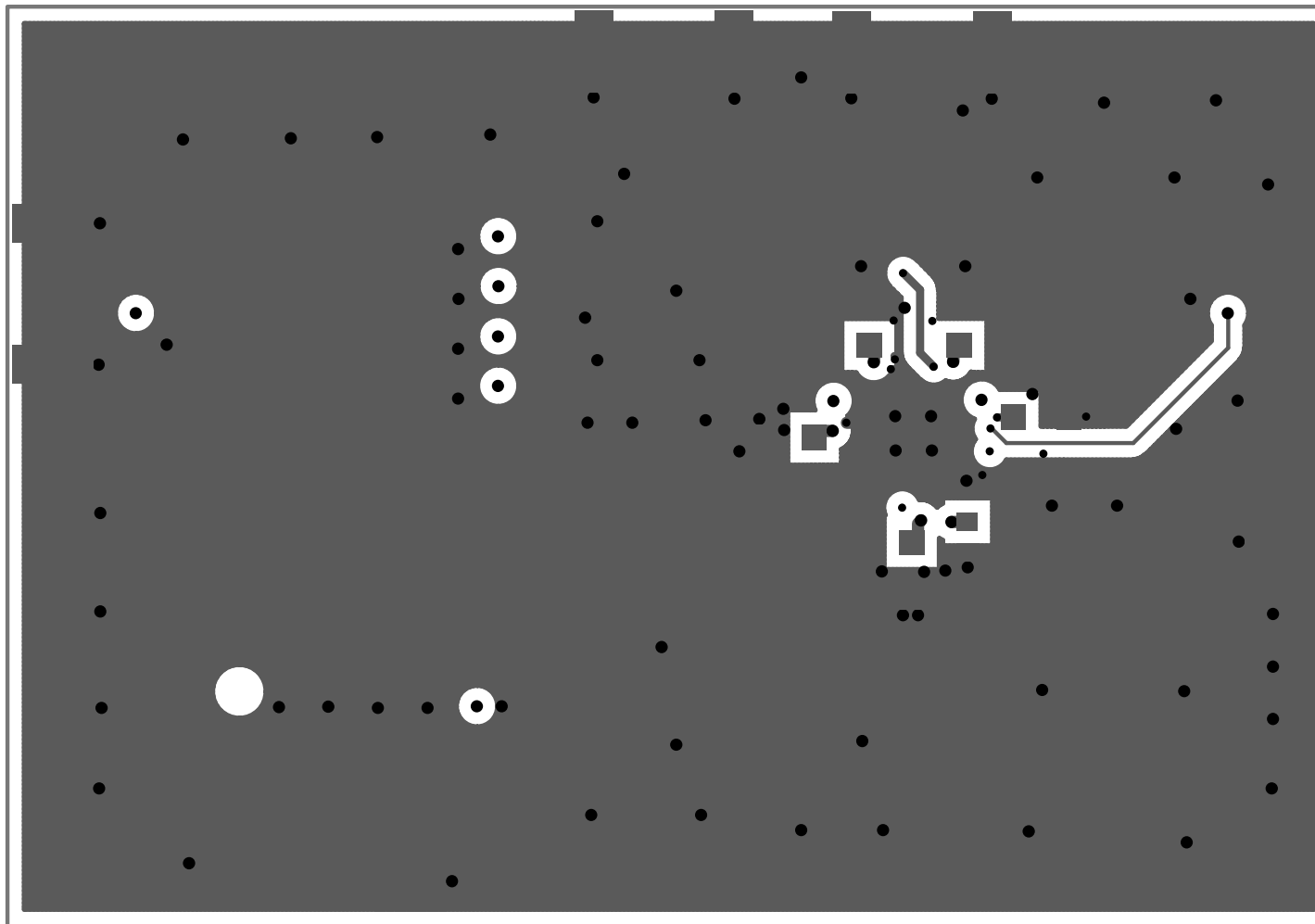

Note: Total Board Thickness = 61 mils

Top Build Diagram

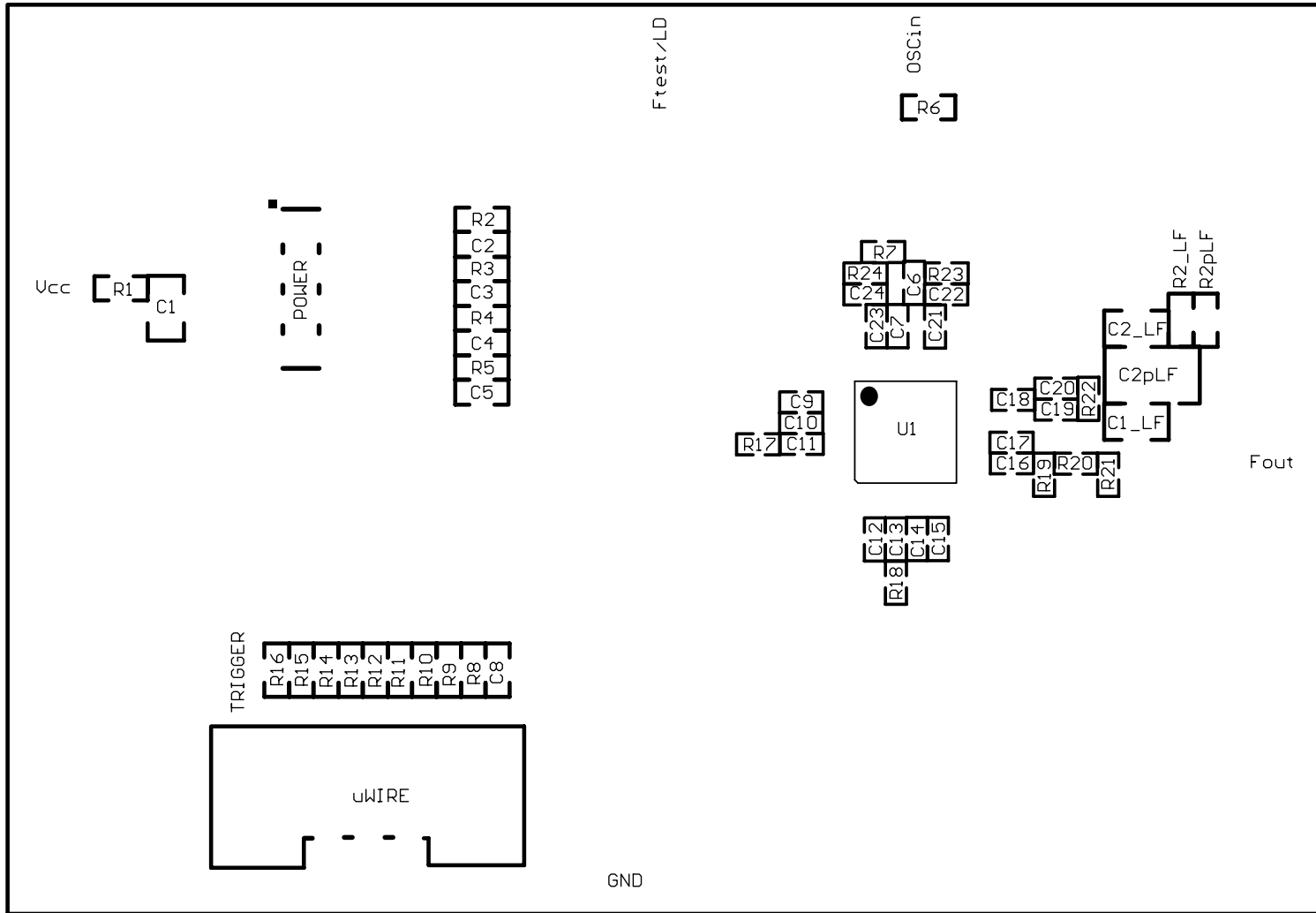

IMPORTANT NOTICE

Texas Instruments Incorporated and its subsidiaries (TI) reserve the right to make corrections, modifications, enhancements, improvements, and other changes to its products and services at any time and to discontinue any product or service without notice. Customers should obtain the latest relevant information before placing orders and should verify that such information is current and complete. All products are sold subject to TI's terms and conditions of sale supplied at the time of order acknowledgment.

TI warrants performance of its hardware products to the specifications applicable at the time of sale in accordance with TI's standard warranty. Testing and other quality control techniques are used to the extent TI deems necessary to support this warranty. Except where mandated by government requirements, testing of all parameters of each product is not necessarily performed.

TI assumes no liability for applications assistance or customer product design. Customers are responsible for their products and applications using TI components. To minimize the risks associated with customer products and applications, customers should provide adequate design and operating safeguards.

TI does not warrant or represent that any license, either express or implied, is granted under any TI patent right, copyright, mask work right, or other TI intellectual property right relating to any combination, machine, or process in which TI products or services are used. Information published by TI regarding third-party products or services does not constitute a license from TI to use such products or services or a warranty or endorsement thereof. Use of such information may require a license from a third party under the patents or other intellectual property of the third party, or a license from TI under the patents or other intellectual property of TI.

Reproduction of TI information in TI data books or data sheets is permissible only if reproduction is without alteration and is accompanied by all associated warranties, conditions, limitations, and notices. Reproduction of this information with alteration is an unfair and deceptive business practice. TI is not responsible or liable for such altered documentation. Information of third parties may be subject to additional restrictions.

Resale of TI products or services with statements different from or beyond the parameters stated by TI for that product or service voids all express and any implied warranties for the associated TI product or service and is an unfair and deceptive business practice. TI is not responsible or liable for any such statements.

TI products are not authorized for use in safety-critical applications (such as life support) where a failure of the TI product would reasonably be expected to cause severe personal injury or death, unless officers of the parties have executed an agreement specifically governing such use. Buyers represent that they have all necessary expertise in the safety and regulatory ramifications of their applications, and acknowledge and agree that they are solely responsible for all legal, regulatory and safety-related requirements concerning their products and any use of TI products in such safety-critical applications, notwithstanding any applications-related information or support that may be provided by TI. Further, Buyers must fully indemnify TI and its representatives against any damages arising out of the use of TI products in such safety-critical applications.

TI products are neither designed nor intended for use in military/aerospace applications or environments unless the TI products are specifically designated by TI as military-grade or "enhanced plastic." Only products designated by TI as military-grade meet military specifications. Buyers acknowledge and agree that any such use of TI products which TI has not designated as military-grade is solely at the Buyer's risk, and that they are solely responsible for compliance with all legal and regulatory requirements in connection with such use.

TI products are neither designed nor intended for use in automotive applications or environments unless the specific TI products are designated by TI as compliant with ISO/TS 16949 requirements. Buyers acknowledge and agree that, if they use any non-designated products in automotive applications, TI will not be responsible for any failure to meet such requirements.

Following are URLs where you can obtain information on other Texas Instruments products and application solutions:

Products

Audio	www.ti.com/audio
Amplifiers	amplifier.ti.com
Data Converters	dataconverter.ti.com
DLP® Products	www.dlp.com
DSP	dsp.ti.com
Clocks and Timers	www.ti.com/clocks
Interface	interface.ti.com
Logic	logic.ti.com
Power Mgmt	power.ti.com
Microcontrollers	microcontroller.ti.com
RFID	www.ti-rfid.com
OMAP Mobile Processors	www.ti.com/omap
Wireless Connectivity	www.ti.com/wirelessconnectivity

Applications

Automotive and Transportation	www.ti.com/automotive
Communications and Telecom	www.ti.com/communications
Computers and Peripherals	www.ti.com/computers
Consumer Electronics	www.ti.com/consumer-apps
Energy and Lighting	www.ti.com/energy
Industrial	www.ti.com/industrial
Medical	www.ti.com/medical
Security	www.ti.com/security
Space, Avionics and Defense	www.ti.com/space-avionics-defense
Video and Imaging	www.ti.com/video

TI E2E Community Home Page

e2e.ti.com

Mailing Address: Texas Instruments, Post Office Box 655303, Dallas, Texas 75265
Copyright © 2012, Texas Instruments Incorporated