

## Overview

The R46 Series is constructed of metallized polypropylene film encapsulated with self-extinguishing resin in a box of material meeting the requirements of UL 94 V-0.

## Applications

For worldwide use in electromagnetic interference (EMI) suppression in across-the-line applications requiring X2 safety classification. Intended for use in situations where capacitor failure would not result in exposure to electric shock. Not for use in "series with mains" type applications.

## Benefits

- Approvals: ENEC, UL, cUL, CQC
- Class X2 (IEC 60384-14)
- Rated voltage: 275 VAC 50/60 Hz
- Capacitance range: 0.01 – 10  $\mu$ F
- Lead spacing: 10.0 – 37.5 mm
- Capacitance tolerance:  $\pm$ 20%,  $\pm$ 10%
- Climatic category: 40/110/56, IEC 60068-1
- Tape and reel in accordance with IEC 60286-2
- RoHS Compliant and lead-free terminations
- Operating temperature range of -40°C to +110°C
- 100% screening factory test at 2,200 VDC/1,500 VAC
- Self-healing properties



## Part Number System

R46	K	I	2100	00	01	M
Series	Rated Voltage (VAC)	Lead Spacing (mm)	Capacitance Code (pF)	Lead and Packaging Code	Internal Use	Capacitance Tolerance
X2, Metallized Polypropylene	K = 275	F = 10.0 I = 15.0 N = 22.5 R = 27.5 W = 37.5	Digits 2 – 4 indicate the first three digits of the capacitance value. First digit indicates the number of zeros to be added.	See Ordering Options Table	01 02 L2 M1 M2 N0 N1 N2	K = $\pm$ 10% M = $\pm$ 20%

## Ordering Options Table

Lead Spacing Nominal (mm)	Type of Leads and Packaging	Lead Length (mm)	Lead and Packaging Code
10, 15, 22.5	<b>Standard Lead and Packaging Options</b>		
	Bulk (Bag) – Short Leads	4 +2/-0	00
	Ammo Pack	H <sub>0</sub> = 18.5 +/-0.5	DQ
	<b>Other Lead and Packaging Options</b>		
	Tape & Reel (Large Reel)	H <sub>0</sub> = 18.5 +/-0.5	CK
	Bulk (Bag) – Short Leads	2.7 +0.5	JA
	Bulk (Bag) – Short Leads	3.5 +0.5	JB
	Bulk (Bag) – Short Leads	4.0 +0.5	JE
	Bulk (Bag) – Short Leads	3.2 +0.3.2	JH
	Bulk (Bag) – Long Leads	18 +1/-1	JM
	Bulk (Bag) – Long Leads	30 +5/-0	40
	Bulk (Bag) – Long Leads	25 +2/-1	50
	Bulk (Bag) – Insulated Rigid Leads	30 +5/-0 (sp 8+2/-2)	51
	Bulk (Bag) – Insulated Flexible Leads	150 +5/-5 (sp 8+2/-2)	52
27.5	<b>Standard Lead and Packaging Options</b>		
	Bulk (Bag) – Short Leads	4 +2/-0	00
	Tape & Reel (Large Reel)	H <sub>0</sub> = 18.5 +/-0.5	CK
	<b>Other Lead and Packaging Options</b>		
	Bulk (Bag) – Short Leads	2.7 +0.5	JA
	Bulk (Bag) – Short Leads	3.5 +0.5	JB
	Bulk (Bag) – Short Leads	4.0 +0.5	JE
	Bulk (Bag) – Short Leads	3.2 +0.3.2	JH
	Bulk (Bag) – Long Leads	18 +1/-1	JM
	Bulk (Bag) – Long Leads	30 +5/-0	40
	Bulk (Bag) – Long Leads	25 +2/-1	50
	Bulk (Bag) – Insulated Rigid Leads	30 +5/-0 (sp 8+2/-2)	51
	Bulk (Bag) – Insulated Flexible Leads	150 +5/-5 (sp 8+2/-2)	52
	37.5	<b>Standard Lead and Packaging Options</b>	
Bulk (Bag) – Short Leads		4 +2/-0	00
<b>Other Lead and Packaging Options</b>			
Bulk (Bag) – Short Leads		2.7 +0.5	JA
Bulk (Bag) – Short Leads		3.5 +0.5	JB
Bulk (Bag) – Short Leads		4.0 +0.5	JE
Bulk (Bag) – Short Leads		3.2 +0.3.2	JH
Bulk (Bag) – Long Leads		18 +1/-1	JM
Bulk (Bag) – Long Leads		30 +5/-0	40
Bulk (Bag) – Long Leads		25 +2/-1	50
Bulk (Bag) – Insulated Rigid Leads		30 +5/-0 (sp 8+2/-2)	51
Bulk (Bag) – Insulated Flexible Leads		150 +5/-5 (sp 8+2/-2)	52

## Dimensions – Millimeters

Loose

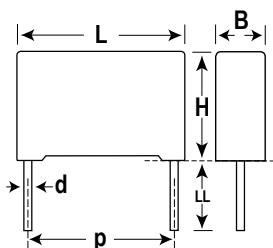

Insulated Rigid Leads

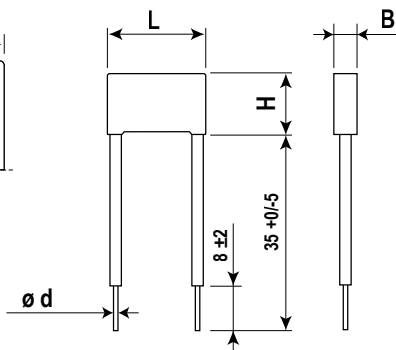

Insulated Flexible Leads 0.5 mm<sup>2</sup>

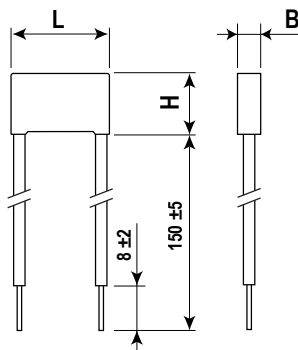

p		B		H		L		d	
Nominal	Tolerance	Nominal	Tolerance	Nominal	Tolerance	Nominal	Tolerance	Nominal	Tolerance
10.0	+/-0.4	4.0	+0.2	9.0	+0.1	13.0	+0.2	0.6	+/-0.05
10.0	+/-0.4	5.0	+0.2	11.0	+0.1	13.0	+0.2	0.6	+/-0.05
10.0	+/-0.4	6.0	+0.2	12.0	+0.1	13.0	+0.2	0.6	+/-0.05
15.0	+/-0.4	5.0	+0.2	11.0	+0.1	18.0	+0.3	0.6	+/-0.05
15.0	+/-0.4	6.0	+0.2	12.0	+0.1	18.0	+0.3	0.6	+/-0.05
15.0	+/-0.4	6.0	+0.2	17.5	+0.1	18.0	+0.3	0.6	+/-0.05
15.0	+/-0.4	7.5	+0.2	13.5	+0.1	18.0	+0.5	0.6	+/-0.05
15.0	+/-0.4	7.5	+0.2	18.5	+0.1	18.0	+0.5	0.8	+/-0.05
15.0	+/-0.4	8.5	+0.2	14.5	+0.1	18.0	+0.5	0.6	+/-0.05
15.0	+/-0.4	9.0	+0.2	12.5	+0.1	18.0	+0.5	0.6	+/-0.05
15.0	+/-0.4	10.0	+0.2	16.0	+0.1	18.0	+0.5	0.8	+/-0.05
15.0	+/-0.4	11.0	+0.2	19.0	+0.1	18.0	+0.5	0.8	+/-0.05
15.0	+/-0.4	13.0	+0.2	12.0	+0.1	18.0	+0.5	0.8	+/-0.05
22.5	+/-0.4	6.0	+0.2	15.0	+0.1	26.5	+0.3	0.8	+/-0.05
22.5	+/-0.4	7.0	+0.2	16.0	+0.1	26.5	+0.3	0.8	+/-0.05
22.5	+/-0.4	10.0	+0.2	18.5	+0.1	26.5	+0.3	0.8	+/-0.05
22.5	+/-0.4	11.0	+0.2	20.0	+0.1	26.5	+0.3	0.8	+/-0.05
27.5	+/-0.4	9.0	+0.2	17.0	+0.1	32.0	+0.3	0.8	+/-0.05
27.5	+/-0.4	11.0	+0.2	20.0	+0.1	32.0	+0.3	0.8	+/-0.05
27.5	+/-0.4	13.0	+0.2	22.0	+0.1	32.0	+0.3	0.8	+/-0.05
27.5	+/-0.4	13.0	+0.2	25.0	+0.1	32.0	+0.3	0.8	+/-0.05
27.5	+/-0.4	14.0	+0.2	28.0	+0.1	32.0	+0.3	0.8	+/-0.05
27.5	+/-0.4	18.0	+0.2	33.0	+0.1	32.0	+0.3	0.8	+/-0.05
27.5	+/-0.4	22.0	+0.2	37.0	+0.1	32.0	+0.3	0.8	+/-0.05
37.5	+/-0.4	11.0	+0.3	22.0	+0.1	41.5	+0.3	1.0	+/-0.05
37.5	+/-0.4	13.0	+0.3	24.0	+0.1	41.5	+0.3	1.0	+/-0.05
37.5	+/-0.4	16.0	+0.3	28.5	+0.1	41.5	+0.3	1.0	+/-0.05
37.5	+/-0.4	19.0	+0.3	32.0	+0.1	41.5	+0.3	1.0	+/-0.05
37.5	+/-0.4	20.0	+0.3	40.0	+0.1	41.5	+0.3	1.0	+/-0.05
37.5	+/-0.4	24.0	+0.3	44.0	+0.1	41.5	+0.3	1.0	+/-0.05
37.5	+/-0.4	30.0	+0.3	45.0	+0.1	41.5	+0.3	1.0	+/-0.05

Note: See Ordering Options Table for lead length (LL/H<sub>0</sub>) options.

## Performance Characteristics

Dielectric	Polypropylene film			
Plates	Metal layer deposited by evaporation under vacuum			
Winding	Non-inductive type			
Leads	Tinned wire			
Protection	Plastic case, thermosetting resin filled. Box material is solvent resistant and flame retardant according to UL94.			
Related documents	IEC 60384-14, EN 60384-14			
Rated Voltage ( $V_R$ )	275 VAC (50/60 Hz), 560 VDC			
Capacitance Range	0.010 $\mu$ F to 10 $\mu$ F			
Capacitance Values	E6 series (IEC 60063) measured @ 1 kHz and +20 $\pm$ 1°C			
Capacitance Tolerance	$\pm$ 10%, $\pm$ 20%			
Temperature Range	-40°C to +110°C			
Climatic Category	40/110/56 IEC 60068-1			
Approvals	ENEC, UL, cUL, CQC			
Dissipation Factor ( $\tan\delta$ )	$\leq$ 0.1% (0.06%*) @ 1kHz, +25°C $\pm$ 5°C (* typical value)			
Test Voltage Between Terminals	The 100% screening factory test is carried out at 2,200 VDC/1,500 VAC. The voltage level is selected to meet the requirements in applicable equipment standards. All electrical characteristics are checked after the test. It is not permitted to repeat this test as there is a risk to damage the capacitor. KEMET is not liable in such case for any failures.			
Insulation Resistance	Measured at +25°C $\pm$ 5°C, according to IEC 60384-2			
	Minimum Values Between Terminals			
	Voltage Charge	Voltage Charge Time	$C \leq 0.33 \mu$ F	$C > 0.33 \mu$ F
	100 VDC	1 min	$\geq 1 \cdot 10^5 \text{ M}\Omega$ ( $\geq 5 \cdot 10^5 \text{ M}\Omega$ )* * typical value	$\geq 30,000 \text{ M}\Omega \cdot \mu$ F ( $\geq 150,000 \text{ M}\Omega \cdot \mu$ F)* * typical value
In DC Applications	Recommended voltage $\leq$ 560 VDC			

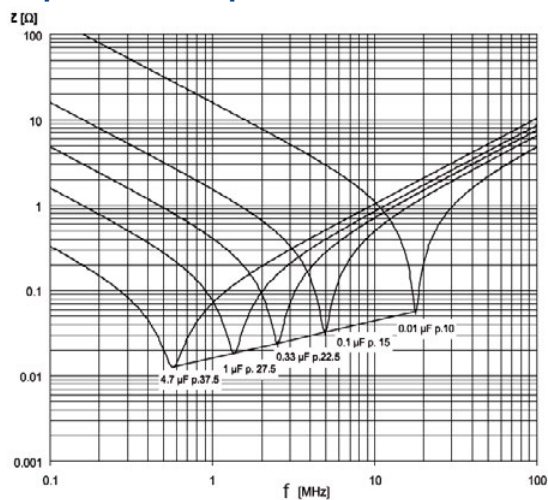

## Impedance Graph



## Environmental Test Data

Test	IEC Publication	Procedure
Endurance	EN/IEC 60384-14	1.25 x V <sub>R</sub> VAC 50 Hz, once every hour increase to 1,000 VAC for 0.1 second, 1,000 hours at upper rated temperature
Vibration	IEC 60068-2-6 Test Fc	3 directions at 2 hours each 10 – 55 Hz at 0.75 mm or 98 m/s <sup>2</sup>
Bump	IEC 60068-2-29 Test Eb	1,000 bumps at 390 m/s <sup>2</sup>
Change of Temperature	IEC 60068-2-14 Test Na	Upper and lower rated temperature 5 cycles
Active Flammability	IEC 60384-14	V <sub>R</sub> + 20 surge pulses at 2.5 kV (pulse every 5 seconds)
Passive Flammability	IEC 60384-14	IEC 60384-1, IEC 60695-11-5 Needle flame test
Damp Heat Steady State	IEC 60068-2-78 Test Cab	+40°C and 93% RH, 56 days

## Approvals

Mark	Specification	File Number
	EN/IEC 60384-14	V4413
	UL 60384-14 and CAN/CSA E60384-14 (310VAC)	E97797
	GB/T 14472	CQC03001008199 CQC08001025808 CQC08001026549 CQC11001060118 CQC12001083745 CQC13001087757

## Environmental Compliance

All KEMET EMI capacitors are RoHS Compliant.



RoHS Compliant

**Table 1 – Ratings & Part Number Reference**

Capacitance Value (µF)	Dimensions in mm			Lead Spacing (p)	dV/dt (V/µs)	New KEMET Part Number	Legacy Part Number
	B	H	L				
0.010	4.0	9.0	13.0	10.0	500	46KF2100(1)N0(2)	R46KF2100(1)N0(2)
0.015	4.0	9.0	13.0	10.0	500	46KF2150(1)N0(2)	R46KF2150(1)N0(2)
0.022	4.0	9.0	13.0	10.0	500	46KF2220(1)N0(2)	R46KF2220(1)N0(2)
0.033	5.0	11.0	13.0	10.0	500	46KF2330(1)M1(2)	R46KF2330(1)M1(2)
0.047	5.0	11.0	13.0	10.0	500	46KF2470(1)N0(2)	R46KF2470(1)N0(2)
0.068	6.0	12.0	13.0	10.0	500	46KF2680(1)M1(2)	R46KF2680(1)M1(2)
0.10	6.0	12.0	13.0	10.0	500	46KF3100(1)M1(3)	R46KF3100(1)M1(3)
0.010	5.0	11.0	18.0	15.0	400	46KI 2100(1)01(2)	R46KI 2100(1)01(2)
0.015	5.0	11.0	18.0	15.0	400	46KI 2150(1)01(2)	R46KI 2150(1)01(2)
0.022	5.0	11.0	18.0	15.0	400	46KI 2220(1)01(2)	R46KI 2220(1)01(2)
0.033	5.0	11.0	18.0	15.0	400	46KI 2330(1)01(2)	R46KI 2330(1)01(2)
0.047	5.0	11.0	18.0	15.0	400	46KI 2470(1)01(2)	R46KI 2470(1)01(2)
0.068	5.0	11.0	18.0	15.0	400	46KI 2680(1)01(2)	R46KI 2680(1)01(2)
0.10	5.0	11.0	18.0	15.0	400	46KI 3100(1)M1(2)	R46KI 3100(1)M1(2)
0.15	6.0	12.0	18.0	15.0	400	46KI 3150(1)M2(2)	R46KI 3150(1)M2(2)
0.15	9.0	12.5	18.0	15.0	400	46KI 3150(1)L2(2)	R46KI 3150(1)L2(2)
0.22	7.5	13.5	18.0	15.0	400	46KI 3200(1)M2(2)	R46KI 3200(1)M2(2)
0.22	9.0	12.5	18.0	15.0	400	46KI 3200(1)L2(2)	R46KI 3200(1)L2(2)
0.22	6.0	17.5	18.0	15.0	400	46KI 3200(1)02(2)	R46KI 3200(1)02(2)
0.33	8.5	14.5	18.0	15.0	400	46KI 3330(1)N0(2)	R46KI 3330(1)N0(2)
0.33	10.0	16.0	18.0	15.0	400	46KI 3330(1)M1(2)	R46KI 3330(1)M1(2)
0.33	9.0	12.5	18.0	15.0	400	46KI 3330(1)N1(3)	R46KI 3330(1)N1(3)
0.33	7.5	18.5	18.0	15.0	400	46KI 3330(1)02(2)	R46KI 3330(1)02(2)
0.33	13.0	12.0	18.0	15.0	400	46KI 3330(1)01(2)	R46KI 3330(1)01(2)
0.47	7.5	18.5	18.0	15.0	400	46KI 3470(1)02(3)	R46KI 3470(1)02(3)
0.47	10.0	16.0	18.0	15.0	400	46KI 3470(1)N0(3)	R46KI 3470(1)N0(3)
0.47	11.0	19.0	18.0	15.0	400	46KI 3470(1)M1(2)	R46KI 3470(1)M1(2)
0.56	11.0	19.0	18.0	15.0	400	46KI 3560(1)N0(2)	R46KI 3560(1)N0(2)
0.60	11.0	19.0	18.0	15.0	400	46KI 3600(1)N0(2)	R46KI 3600(1)N0(2)
0.15	6.0	15.0	26.5	22.5	200	46KN3150(1)01(2)	R46KN3150(1)01(2)
0.22	6.0	15.0	26.5	22.5	200	46KN3220(1)M1(2)	R46KN3220(1)M1(2)
0.33	6.0	15.0	26.5	22.5	200	46KN3330(1)N0(2)	R46KN3330(1)N0(2)
0.47	7.0	16.0	26.5	22.5	200	46KN3470(1)N0(2)	R46KN3470(1)N0(2)
0.68	10.0	18.5	26.5	22.5	200	46KN3680(1)M2(2)	R46KN3680(1)M2(2)
1.00	10.0	18.5	26.5	22.5	200	46KN4100(1)N2(3)	R46KN4100(1)N2(3)
1.00	11.0	20.0	26.5	22.5	200	46KN4100(1)N1(2)	R46KN4100(1)N1(2)
0.47	9.0	17.0	32.0	27.5	150	46KR3470(1)01(2)	R46KR3470(1)01(2)
0.68	9.0	17.0	32.0	27.5	150	46KR3680(1)M1(2)	R46KR3680(1)M1(2)
1.0	11.0	20.0	32.0	27.5	150	46KR4100(1)M1(2)	R46KR4100(1)M1(2)
1.5	13.0	22.0	32.0	27.5	150	46KR4150(1)M1(2)	R46KR4150(1)M1(2)
2.2	13.0	25.0	32.0	27.5	150	46KR4220(1)M2(2)	R46KR4220(1)M2(2)
2.2	14.0	28.0	32.0	27.5	150	46KR4220(1)M1(2)	R46KR4220(1)M1(2)
3.3	18.0	33.0	32.0	27.5	150	46KR4330(1)M2(2)	R46KR4330(1)M2(2)
4.7	18.0	33.0	32.0	27.5	150	46KR4470(1)M2(2)	R46KR4470(1)M2(2)
4.7	22.0	37.0	32.0	27.5	150	46KR4470(1)M1(2)	R46KR4470(1)M1(2)
1.5	11.0	22.0	41.5	37.5	100	46KW4150(1)M1(2)	R46KW4150(1)M1(2)
2.2	11.0	22.0	41.5	37.5	100	46KW4220(1)M2(3)	R46KW4220(1)M2(3)
2.2	13.0	24.0	41.5	37.5	100	46KW4220(1)M1(2)	R46KW4220(1)M1(2)
3.3	16.0	28.5	41.5	37.5	100	46KW4330(1)M1(2)	R46KW4330(1)M1(2)
4.7	16.0	28.5	41.5	37.5	100	46KW4470(1)M2(3)	R46KW4470(1)M2(3)
4.7	19.0	32.0	41.5	37.5	100	46KW4470(1)M1(2)	R46KW4470(1)M1(2)
6.8	20.0	40.0	41.5	37.5	100	46KW4680(1)M2(2)	R46KW4680(1)M2(2)
6.8	24.0	44.0	41.5	37.5	100	46KW4680(1)M1(2)	R46KW4680(1)M1(2)
10.0	30.0	45.0	41.5	37.5	100	46KW5100(1)M1(2)	R46KW5100(1)M1(2)

(1) Insert lead and packaging code. See Ordering Options Table for available options.

(2) M = ±20%, K = ±10%

(3) M = ±20% (only available tolerance).

## Soldering Process

The implementation of the RoHS directive has resulted in the selection of SnAuCu (SAC) alloys or SnCu alloys as primary solder. This has increased the liquidus temperature from that of 183°C for SnPb eutectic alloy to 217 – 221°C for the new alloys. As a result, the heat stress to the components, even in wave soldering, has increased considerably due to higher pre-heat and wave temperatures. Polypropylene capacitors are especially sensitive to heat (the melting point of polypropylene is 160 – 170°C). Wave soldering can be destructive, especially for mechanically small polypropylene capacitors (with lead spacing of 5 mm to 15 mm), and great care has to be taken during soldering. The recommended solder profiles from KEMET should be used. Please consult KEMET with any questions. In general, the wave soldering curve from IEC Publication 61760-1 Edition 2 serves as a solid guideline for successful soldering. Please see Figure 1.

Reflow soldering is not recommended for through-hole film capacitors. Exposing capacitors to a soldering profile in excess of the above the recommended limits may result to degradation or permanent damage to the capacitors.

Do not place the polypropylene capacitor through an adhesive curing oven to cure resin for surface mount components. Insert through-hole parts after the curing of surface mount parts. Consult KEMET to discuss the actual temperature profile in the oven, if through-hole components must pass through the adhesive curing process. A maximum two soldering cycles is recommended. Please allow time for the capacitor surface temperature to return to a normal temperature before the second soldering cycle.

### Manual Soldering Recommendations

Following is the recommendation for manual soldering with a soldering iron.

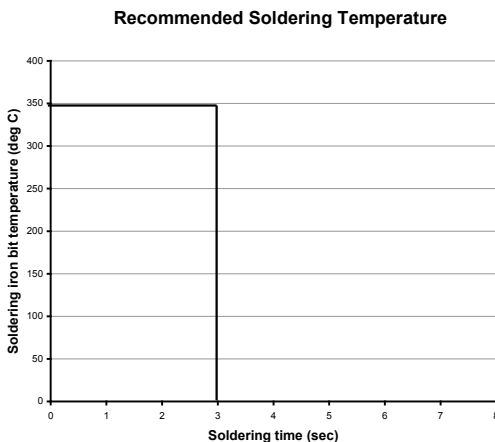

The soldering iron tip temperature should be set at 350°C (+10°C maximum) with the soldering duration not to exceed more than 3 seconds.

### Wave Soldering Recommendations

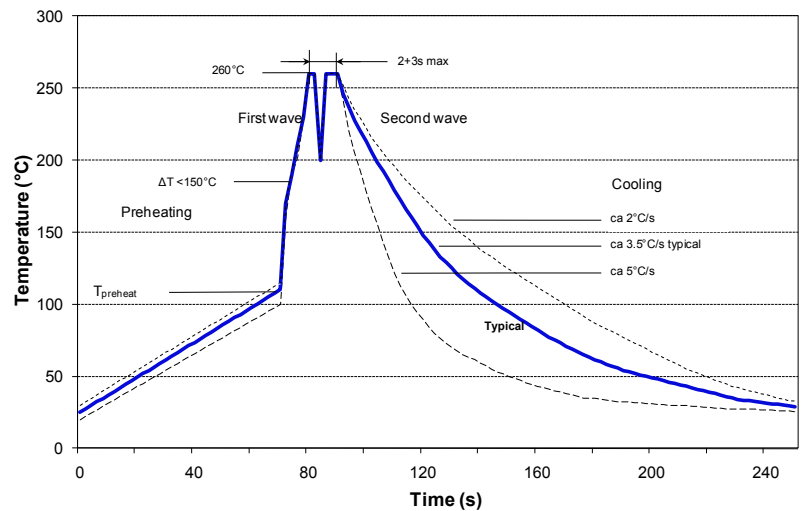

Figure 1

Dielectric Film Material	Maximum Preheat Temperature			Maximum Peak Soldering Temperature	
	Capacitor Pitch $\leq 10$ mm	Capacitor Pitch = 15 mm	Capacitor Pitch $> 15$ mm	Capacitor Pitch $\leq 15$ mm	Capacitor Pitch $> 15$ mm
Polyester	130°C	130°C	130°C	270°C	270°C
Polypropylene	100°C	110°C	130°C	260°C	270°C
Polyphenylene Sulphide	150°C	150°C	160°C	270°C	270°C

## Soldering Process cont'd

### Selective Soldering Recommendations

Selective dip soldering is a variation of reflow soldering. In this method, the printed circuit board with through-hole components to be soldered is preheated and transported over the solder bath as in normal flow soldering without touching the solder. When the board is over the bath, it is stopped and pre-designed solder pots are lifted from the bath with molten solder only at the places of the selected components, and pressed against the lower surface of the board to solder the components.

The temperature profile for selective soldering is similar to the double wave flow soldering outlined in this document, **however, instead of two baths, there is only one bath with a time from 3 to 10 seconds.** In selective soldering, the risk of overheating is greater than in double wave flow soldering, and great care must be taken so that the parts are not overheated.

## Marking

- KEMET logo
- Series
- Capacitance
- Capacitance tolerance
- Rated voltage
- Capacitor class
- Approval marks
- Manufacturing date code
- IEC climatic category
- Passive flammability class
- Manufacturing plant

Manufacturing Date Code (IEC 60062)			
Y = Year, Z = Month			
Year	Code	Month	Code
2000	M	January	1
2001	N	February	2
2002	P	March	3
2003	R	April	4
2004	S	May	5
2005	T	June	6
2006	U	July	7
2007	V	August	8
2008	W	September	9
2009	X	October	O
2010	A	November	N
2011	B	December	D
2012	C		
2013	D		
2014	E		
2015	F		
2016	H		
2017	J		
2018	K		
2019	L		
2020	M		



## Packaging Quantities

Lead Spacing (mm)	Thickness (mm)	Height (mm)	Length (mm)	Bulk Short Leads	Bulk Long Leads	Standard Reel ø 355 mm	Large Reel ø 500 mm	Ammo Taped
10	4	9	13	2000	1800	750	1500	1000
	5	11	13	1300	1500	600	1250	800
	6	12	13	1000	1200	500	1000	680
15	5	11	18	2000	1000	600	1250	800
	6	12	18	1750	900	500	1000	680
	6	17.5	18	1000	700	500	1000	680
	7.5	13.5	18	1000	700	350	800	500
	7.5	18.5	18	900	500	–	800	500
	8.5	14.5	18	1000	500	300	700	440
	9	12.5	18	1000	520	270	650	410
	10	16	18	750	500	300	600	380
	11	19	18	450	350	–	500	340
13	12	18	750	490	200	480	280	
22.5	6	15	26.5	805	500	–	700	464
	7	16	26.5	700	500	–	550	380
	10	18.5	26.5	396	300	–	350	235
	11	20	26.5	360	250	–	350	217
27.5	9	17	32	816	408	–	450	–
	11	20	32	560	336	–	350	–
	13	22	32	480	288	–	300	–
	13	25	32	480	288	–	–	–
	14	28	32	352	176	–	–	–
	18	33	32	256	128	–	–	–
	22	37	32	168	112	–	–	–
37.5	11	22	41.5	420	252	–	–	–
	13	24	41.5	360	216	–	–	–
	16	28.5	41.5	216	108	–	–	–
	19	32	41.5	192	96	–	–	–
	20	40	41.5	126	84	–	–	–
	24	44	41.5	108	72	–	–	–
	30	45	41.5	90	60	–	–	–

## Lead Taping & Packaging (IEC 60286-2)

**Figure 1**  
Lead Spacing 10 mm

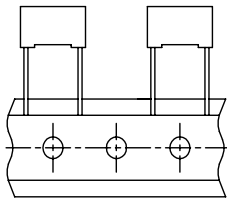

**Figure 2**  
Lead Spacing 15 mm

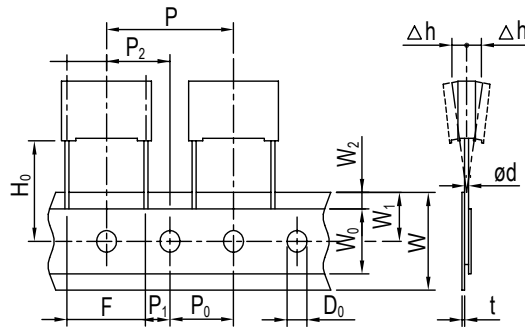

**Figure 3**  
Lead Spacing 22.5 – 27.5 mm

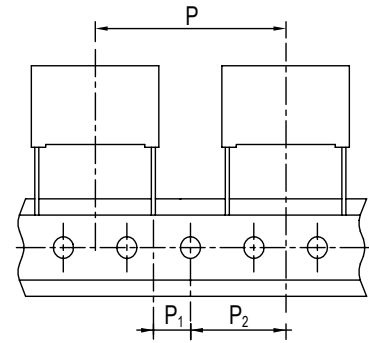

## Taping Specification

Description	Symbol	Dimensions (mm)				Tol.
		Lead Space				
		10 Fig. 1	15 Fig. 2	22.5 Fig. 3	27.5 Fig. 3	
Lead wire diameter	d	0.6	0.6-0.8	0.8	0.8	±0.05
Taping lead space	P	25.4	25.4	38.1	38.1	±1
Feed hole lead space *	P <sub>0</sub>	12.7	12.7	12.7	12.7	±0.2 **
Centering of the lead wire	P <sub>1</sub>	7.7	5.2	7.8	5.3	±0.7
Centering of the body	P <sub>2</sub>	12.7	12.7	19.05	19.05	±1.3
Lead spacing (pitch) ***	F	10	15	22.5	27.5	+0.6/-0.1
Component alignment	Δh	0	0	0	0	±2
Height of component from tape center	H <sub>0</sub> ****	18.5	18.5	18.5	18.5	±0.5
Carrier tape width	W	18	18	18	18	+1 / -0.5
Hold down tape width	W <sub>0</sub>	9	10	10	10	Minimum
Hole position	W <sub>1</sub>	9	9	9	9	±0.5
Hold down tape position	W <sub>2</sub>	3	3	3	3	Maximum
Feed hole diameter	D <sub>0</sub>	4	4	4	4	±0.2
Tape thickness	t	0.7	0.7	0.7	0.7	±0.2

\* Also available in 15 mm.

\*\* Max 1 mm on 20 lead spaces.

\*\*\* Pitches 15 mm and 10 mm taped to 7.5 mm (crimped leads) available upon request.

\*\*\*\* H<sub>0</sub> = 16.5 mm available upon request.

## Lead Taping & Packaging (IEC 60286-2) cont'd

### Ammo Specifications

Dimensions (mm)		
H	W	T
360	340	59

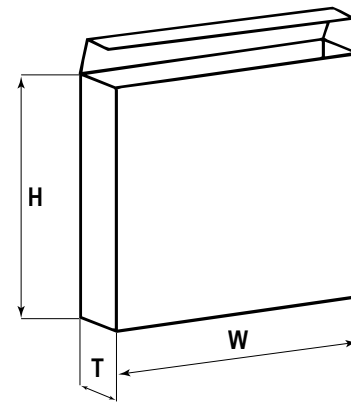

### Reel Specifications

Reel Size	Dimensions (mm)		
	D	H	W
Standard	355	30	55 Maximum
Large	500	25	

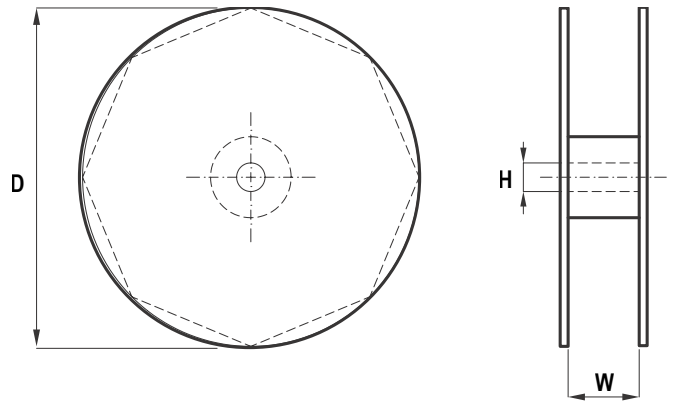

## KEMET Corporation World Headquarters

2835 KEMET Way  
Simpsonville, SC 29681

Mailing Address:  
P.O. Box 5928  
Greenville, SC 29606

www.kemet.com  
Tel: 864-963-6300  
Fax: 864-963-6521

**Corporate Offices**  
Fort Lauderdale, FL  
Tel: 954-766-2800

## North America

**Southeast**  
Lake Mary, FL  
Tel: 407-855-8886

**Northeast**  
Wilmington, MA  
Tel: 978-658-1663

**Central**  
Novi, MI  
Tel: 248-306-9353

**West**  
Milpitas, CA  
Tel: 408-433-9950

**Mexico**  
Guadalajara, Jalisco  
Tel: 52-33-3123-2141

## Europe

**Southern Europe**  
Paris, France  
Tel: 33-1-4646-1006

Sasso Marconi, Italy  
Tel: 39-051-939111

**Central Europe**  
Landsberg, Germany  
Tel: 49-8191-3350800

Kamen, Germany  
Tel: 49-2307-438110

**Northern Europe**  
Bishop's Stortford, United Kingdom  
Tel: 44-1279-460122

Espoo, Finland  
Tel: 358-9-5406-5000

## Asia

**Northeast Asia**  
Hong Kong  
Tel: 852-2305-1168

Shenzhen, China  
Tel: 86-755-2518-1306

Beijing, China  
Tel: 86-10-5829-1711

Shanghai, China  
Tel: 86-21-6447-0707

Taipei, Taiwan  
Tel: 886-2-27528585

**Southeast Asia**  
Singapore  
Tel: 65-6586-1900

Penang, Malaysia  
Tel: 60-4-6430200

Bangalore, India  
Tel: 91-806-53-76817

*Note: KEMET reserves the right to modify minor details of internal and external construction at any time in the interest of product improvement. KEMET does not assume any responsibility for infringement that might result from the use of KEMET Capacitors in potential circuit designs. KEMET is a registered trademark of KEMET Electronics Corporation.*

## Disclaimer

All product specifications, statements, information and data (collectively, the "Information") in this datasheet are subject to change. The customer is responsible for checking and verifying the extent to which the Information contained in this publication is applicable to an order at the time the order is placed.

All Information given herein is believed to be accurate and reliable, but it is presented without guarantee, warranty, or responsibility of any kind, expressed or implied.

Statements of suitability for certain applications are based on KEMET Electronics Corporation's ("KEMET") knowledge of typical operating conditions for such applications, but are not intended to constitute – and KEMET specifically disclaims – any warranty concerning suitability for a specific customer application or use. The Information is intended for use only by customers who have the requisite experience and capability to determine the correct products for their application. Any technical advice inferred from this Information or otherwise provided by KEMET with reference to the use of KEMET's products is given gratis, and KEMET assumes no obligation or liability for the advice given or results obtained.

Although KEMET designs and manufactures its products to the most stringent quality and safety standards, given the current state of the art, isolated component failures may still occur. Accordingly, customer applications which require a high degree of reliability or safety should employ suitable designs or other safeguards (such as installation of protective circuitry or redundancies) in order to ensure that the failure of an electrical component does not result in a risk of personal injury or property damage.

Although all product-related warnings, cautions and notes must be observed, the customer should not assume that all safety measures are indicated or that other measures may not be required.