

FEATURES

- I/Q demodulator with integrated fractional-N PLL
- RF input frequency range: 695 MHz to 2700 MHz
- Internal LO frequency range: 356.25 MHz to 2850 MHz
- Input P1dB: 14.5 dBm at 1900 MHz RF
- Input IP3: 35 dBm at 1900 MHz RF
- Programmable HD3/IP3 trim
- Single pole, double throw (SPDT) RF input switch
- RF digital step attenuation range: 0 dB to 15 dB
- Integrated RF tunable balun for single-ended 50 Ω input
- Multicore integrated VCO
- Demodulated 1 dB bandwidth: 600 MHz
- 4 selectable baseband gain and bandwidth modes
- Digital programmable LO phase offset and dc nulling
- Programmable via 3-wire serial port interface (SPI)
- 40-lead, 6 mm \times 6 mm LFCSP

APPLICATIONS

- Cellular W-CDMA/GSM/LTE
- Digital predistortion (DPD) receivers
- Microwave point-to-point radios

GENERAL DESCRIPTION

The [ADRF6820](#) is a highly integrated demodulator and synthesizer ideally suited for next generation communication systems. The feature rich device consists of a high linearity broadband I/Q demodulator, an integrated fractional-N phase-locked loop (PLL), and a low phase noise multicore, voltage controlled oscillator (VCO). The [ADRF6820](#) also integrates a 2:1 RF switch, an on-chip tunable RF balun, a programmable RF attenuator, and two low dropout (LDO) regulators. This highly integrated device fits within a small 6 mm \times 6 mm footprint.

The high isolation 2:1 RF switch and on-chip tunable RF balun enable the [ADRF6820](#) to support two single-ended, 50 Ω terminated RF inputs. A programmable attenuator ensures an optimal differential RF input level to the high linearity demodulator core. The integrated attenuator offers an attenuation range of 0 dB to 15 dB with a step size of 1 dB.

The [ADRF6820](#) offers two alternatives for generating the differential local oscillator (LO) input signal: externally via a high frequency, low phase noise LO signal or internally via the

FUNCTIONAL BLOCK DIAGRAM

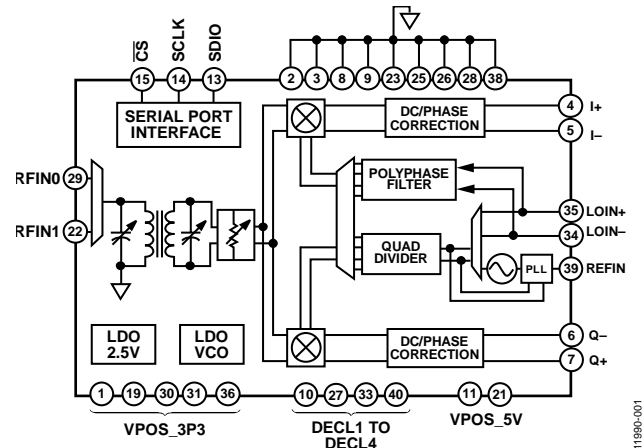

Figure 1.

on-chip fractional-N synthesizer. The integrated synthesizer enables continuous LO coverage from 356.25 MHz to 2850 MHz. The PLL reference input can support a wide frequency range because the divide or multiplication blocks can increase or decrease the reference frequency to the desired value before it is passed to the phase frequency detector (PFD).

When selected, the output of the internal fractional-N synthesizer is applied to a divide-by-2 quadrature phase splitter. From the external LO path, a 1 \times LO signal can be applied to the built-in polyphase filter, or a 2 \times LO signal can be used with the divide-by-2 quadrature phase splitter to generate the quadrature LO inputs to the mixers.

The [ADRF6820](#) is fabricated using an advanced silicon-germanium BiCMOS process. It is available in a 40-lead, RoHS-compliant, 6 mm \times 6 mm LFCSP package with an exposed paddle. Performance is specified over the -40°C to $+85^{\circ}\text{C}$ temperature range.

TABLE OF CONTENTS

| | | | |
|--|----|--|----|
| Features | 1 | RF Attenuator | 15 |
| Applications..... | 1 | LO Generation Block..... | 15 |
| Functional Block Diagram | 1 | Active Mixers | 17 |
| General Description | 1 | Baseband Buffers | 17 |
| Revision History | 2 | Serial Port Interface (SPI) | 17 |
| Specifications..... | 3 | Applications Information | 18 |
| System Specifications | 3 | Basic Connections..... | 18 |
| Dynamic Performance..... | 3 | RF Balun Insertion Loss Optimization | 20 |
| Synthesizer/PLL Specifications..... | 5 | Bandwidth Select Modes | 22 |
| Digital Logic Specifications..... | 6 | IP3 and Noise Figure Optimization..... | 24 |
| Absolute Maximum Ratings..... | 7 | I/Q Output Loading | 26 |
| Thermal Resistance | 7 | Image Rejection | 27 |
| ESD Caution..... | 7 | I/Q Polarity..... | 28 |
| Pin Configuration and Function Descriptions..... | 8 | Layout | 29 |
| Typical Performance Characteristics | 9 | Register Map | 30 |
| Theory of Operation | 14 | Register Address Descriptions..... | 31 |
| RF Input Switch | 14 | Outline Dimensions | 45 |
| Tunable Balun | 14 | Ordering Guide | 45 |

REVISION HISTORY

3/14—Rev. 0 to Rev. A

| | |
|--|----|
| Changes to Features Section..... | 1 |
| Added LO Harmonic Rejection Parameter and DSA Attenuation Accuracy Parameter, Table 1 | 3 |
| Changes to Table 2..... | 3 |
| Changes to Table 3..... | 5 |
| Changes to Figure 5 and Figure 8..... | 9 |
| Changes to Figure 21 and Figure 22..... | 12 |
| Changes to Table 17..... | 30 |
| Added Address: 0x44, Reset: 0x0000, Name: DIV_SM_CTL Section and Table 36; Renumbered Sequentially | 43 |
| Changes to Address: 0x45, Reset: 0x0000, Name: VCO_CTL2 Section and Table 37..... | 44 |
| Added Address: 0x46, Reset: 0x0000, Name: VCO_RB Section and Table 38..... | 44 |

12/13—Revision 0: Initial Version

SPECIFICATIONS

SYSTEM SPECIFICATIONS

VPOS_5V = 5 V, VPOS_3P3 = 3.3 V, ambient temperature (T_A) = 25°C, high-side LO injection, internal LO mode, RF attenuation range = 0 dB, input IP2/input IP3 tone spacing = 5 MHz and -5 dBm per tone, f_{IF} = 40 MHz for BWSEL = 0 and f_{IF} = 200 MHz for BWSEL = 2.

Table 1.

| Parameter | Test Conditions/Comments | Min | Typ | Max | Unit |
|------------------------------------|---|--------|-----------|------|----------|
| RF INPUT | | | | | MHz |
| RF Frequency Range | | 695 | | 2700 | MHz |
| Return Loss | | | 15 | | dB |
| Input Impedance | | | 50 | | Ω |
| Input Power | | | | 18 | dBm |
| LO INTERNAL FREQUENCY | | | | | MHz |
| LO Internal Frequency Range | | 356.25 | | 2850 | MHz |
| External LO Frequency Range | | 350 | | 6000 | MHz |
| LO Input Level | | -6 | | +6 | dBm |
| LO Input Impedance | | | 50 | | Ω |
| LO Harmonic Rejection ¹ | 2xLO at output of external LO (LO = 1900 MHz) | | -30 | | dBc |
| SUPPLY VOLTAGE | | | | | V |
| VPOS_3P3 | | 3.1 | 3.3 | 3.5 | V |
| VPOS_5V | | 4.7 | 5.0 | 5.25 | V |
| RF ATTENUATION RANGE | Step size = 1 dB | 0 | | 15 | dB |
| Digital Step Attenuator (DSA) | Step error between two adjacent DSA code | | ± 0.5 | | dB |
| | Attenuation accuracy | | ± 1.0 | | dB |
| IF OUTPUTS | | | | | |
| Gain Flatness | Across any 20 MHz bandwidth | | 0.2 | | dB |
| Quadrature Phase Error | No correction applied | | 1 | | Degrees |
| I/Q Amplitude Imbalance | No correction applied | | 0.1 | | dB |
| Output DC Offset | No correction applied | | 20 | | mV |
| Output Common Mode | | 1.5 | | 2.4 | V |
| I/Q Output Impedance | Differential | | 50 | | Ω |
| TOTAL POWER CONSUMPTION | | | | | |
| | External LO, polyphase filter LO path | | 1100 | | mW |
| | Internal PLL/VCO, 2x LO path | | 1400 | | mW |

¹ Measured with a nominal device with normal supply and temperature.

DYNAMIC PERFORMANCE

Table 2.

| Parameter | Test Conditions/Comments | BWSEL0 ¹ | | | BWSEL2 ¹ | | | Unit |
|------------------------|---------------------------------------|---------------------|-------|-----|---------------------|-------|-----|------|
| | | Min | Typ | Max | Min | Typ | Max | |
| DEMODULATION BANDWIDTH | 1 dB bandwidth, f_{LO} = 2100 MHz | | 240 | | | 600 | | MHz |
| | 3 dB bandwidth, f_{LO} = 2100 MHz | | 480 | | | 1400 | | MHz |
| f_{RF} = 900 MHz | | | | | | | | |
| Conversion Gain | Voltage gain | | +3.5 | | | -2.5 | | dB |
| Input P1dB | | | 11 | | | 14 | | dBm |
| Input IP3 | | | 34 | | | 38 | | dBm |
| Input IP2 | | | 65 | | | 61 | | dBm |
| Noise Figure | Internal LO | | 17 | | | 19 | | dB |
| | External LO | | 16 | | | 18.5 | | dB |
| LO to RF Leakage | | | -82 | | | -82 | | dBm |
| RF to LO Leakage | | | -67 | | | -67 | | dBm |
| LO to IF Leakage | With respect to -5 dBm RF input power | | -78.5 | | | -78.5 | | dBc |

| Parameter | Test Conditions/Comments | BWSEL0 ¹ | | | BWSEL2 ¹ | | | Unit |
|---|---|---------------------|-------|-----|---------------------|-------|-----|------|
| | | Min | Typ | Max | Min | Typ | Max | |
| RF to IF Leakage Isolation ² | With respect to -5 dBm RF input power Isolation between RFIN0 to RFIN1 Isolation between RFIN1 to RFIN0 | -49 | | | -49 | | | dBc |
| | | -55 | | | -55 | | | dBc |
| | | -55 | | | -55 | | | dBc |
| $f_{RF} = 1900$ MHz | | | | | | | | |
| Conversion Gain | Voltage gain | | +3 | | | -3 | | dB |
| Input P1dB | | | 12 | | | 14.5 | | dBm |
| Input IP3 | | | 33 | | | 35 | | dBm |
| Input IP2 | | | 58 | | | 57 | | dBm |
| Noise Figure | Internal LO | | 18 | | | 20 | | dB |
| | External LO | | 17.5 | | | 19.5 | | dB |
| LO to RF Leakage | | | -75 | | | -75 | | dBm |
| RF to LO Leakage | | | -64 | | | -64 | | dBm |
| LO to IF Leakage | With respect to -5 dBm RF input power | | -64.5 | | | -64.5 | | dBc |
| RF to IF Leakage | With respect to -5 dBm RF input power | | -43.5 | | | -43.5 | | dBc |
| Isolation ² | Isolation between RFIN0 to RFIN1 | | -51 | | | -51 | | dBc |
| | Isolation between RFIN1 to RFIN0 | | -39 | | | -39 | | dBc |
| $f_{RF} = 2100$ MHz | | | | | | | | |
| Conversion Gain | Voltage gain | | +2.5 | | | -3 | | dB |
| Input P1dB | | | 12 | | | 15.5 | | dBm |
| Input IP3 | | | 37 | | | 34 | | dBm |
| Input IP2 | | | 58 | | | 55 | | dBm |
| Noise Figure | Internal LO | | 18 | | | 20.5 | | dB |
| | External LO | | 18 | | | 20 | | dB |
| LO to RF Leakage | | | -72.5 | | | -72.5 | | dBm |
| RF to LO Leakage | | | -62 | | | -62 | | dBm |
| LO to IF Leakage | With respect to -5 dBm RF input power | | -71 | | | -71 | | dBc |
| RF to IF Leakage | With respect to -5 dBm RF input power | | -45 | | | -45 | | dBc |
| Isolation ² | Isolation between RFIN0 to RFIN1 | | -48.5 | | | -48.5 | | dBc |
| | Isolation between RFIN1 to RFIN0 | | -36.5 | | | -36.5 | | dBc |
| $f_{RF} = 2650$ MHz | | | | | | | | |
| Conversion Gain | Voltage gain | | +1.5 | | | -4 | | dB |
| Input P1dB | | | 13 | | | 16.5 | | dBm |
| Input IP3 | | | 33 | | | 33 | | dBm |
| Input IP2 | | | 64 | | | 55 | | dBm |
| Noise Figure | Internal LO | | 19.5 | | | 22 | | dB |
| | External LO | | 19.5 | | | 21.5 | | dB |
| LO to RF Leakage | | | -70 | | | -70 | | dBm |
| RF to LO Leakage | | | -57 | | | -57 | | dBm |
| LO to IF Leakage | With respect to -5 dBm RF input power | | -76 | | | -76 | | dBc |
| RF to IF Leakage | With respect to -5 dBm RF input power | | -46 | | | -46 | | dBc |
| Isolation ² | Isolation between RFIN0 to RFIN1 | | -40.5 | | | -40.5 | | dBc |
| | Isolation between RFIN1 to RFIN0 | | -33 | | | -33 | | dBc |

¹ See Table 15.² This is the isolation between the RF inputs. An input signal was applied to RFIN0, while RFIN1 was terminated with 50 Ω . The IF signal amplitude was measured at the baseband output. Next, the internal switch was configured for RFIN1, and the feedthrough was measured as a delta from the fundamental. This difference is recorded as isolation between RFIN0 and RFIN1.

SYNTHESIZER/PLL SPECIFICATIONS

VPOS_5V = 5 V, VPOS_3P3 = 3.3 V, ambient temperature (T_A) = 25°C, f_{REF} = 153.6 MHz, f_{REF} power = 4 dBm, f_{PFD} = 38.4 MHz, loop filter bandwidth = 20 kHz, measured at LO output,

Table 3.

| Parameter | Test Conditions/Comments | Min | Typ | Max | Unit |
|-------------------------------------|--|--------|--------|------|----------------|
| PLL REFERENCE | | | | | |
| Frequency | | 12 | | 320 | MHz |
| Amplitude | | | 4 | 14 | dBm |
| PLL Step Size ¹ | PFD = 30.72 MHz | 468.76 | | | Hz |
| PLL Lock Time ² | PFD = 30.72 MHz, charge pump = 500 μ A, loop bandwidth = 40 kHz, antibacklash delay = 0.5 ns, charge pump bleed current = 78.125 μ A down | | 5 | | ms |
| PFD FREQUENCY | | 24 | | 40 | MHz |
| INTERNAL VCO RANGE | | 2850 | | 5700 | MHz |
| REFERENCE SPURS | f_{REF} = 153.6 MHz, f_{PFD} = 38.4 MHz, f_{LO} = 1809.6 MHz | | | | |
| | $f_{PFD}/4$ | | <-100 | | dBc |
| | $f_{PFD}/2$ | | <-100 | | dBc |
| | $f_{PFD} \times 1$ | | -90.67 | | dBc |
| | $f_{PFD} \times 2$ | | -95 | | dBc |
| | $f_{PFD} \times 3$ | | -97 | | dBc |
| | $f_{PFD} \times 4$ | | <-100 | | dBc |
| | $f_{PFD} \times 5$ | | <-100 | | dBc |
| INTEGRATED PHASE NOISE ³ | 1 kHz to 40 MHz integration bandwidth, PFD = 38.4 MHz, f_{REF} = 153.6 MHz, divide by 4, charge pump = 250 μ A, loop bandwidth = 20 kHz, antibacklash delay = 0 ns, charge pump bleed current = 46.8 μ A down, LO frequency = 1562.5 MHz | | 0.6 | | $^{\circ}$ rms |
| CLOSED-LOOP PERFORMANCE | f_{LO} = 1809.6, f_{REF} = 153.6 MHz, f_{PFD} = 38.4 MHz | | | | |
| 20 kHz Loop Filter | 10 kHz offset | | -94.7 | | dBc/Hz |
| | 20 kHz offset | | -95.8 | | dBc/Hz |
| | 100 kHz offset | | -113 | | dBc/Hz |
| | 200 kHz offset | | -122.4 | | dBc/Hz |
| | 600 kHz offset | | -136.5 | | dBc/Hz |
| | 1 MHz offset | | -141.5 | | dBc/Hz |
| | 10 MHz offset | | -153.3 | | dBc/Hz |
| | 40 MHz offset | | -154.6 | | dBc/Hz |

¹ Minimum PLL step size is a function of PFD. Value shown is based on PFD = 30.72 MHz, LO_DIV = 2, and the formula $f_{PFD}/65535 \times 2/LO_DIV$.

² Lock time is defined as the time it takes from the end of a register write for a change in frequency to the point where the frequency of the output is within 500 Hz of the intended frequency.

³ Measured with a nominal device with normal supply and temperature.

DIGITAL LOGIC SPECIFICATIONS

Table 4.

| Parameter | Test Conditions/Comments | Min | Typ | Max | Unit |
|---|--------------------------|-----|------|-----|------|
| Input Voltage High, V_{IH} | | 1.4 | | | V |
| Input Voltage Low, V_{IL} | | | 0.70 | | V |
| Output Voltage High, V_{OH} | $I_{OH} = -100 \mu A$ | 2.3 | | | V |
| Output Voltage Low, V_{OL} | $I_{OL} = 100 \mu A$ | 0.2 | | | V |
| Serial Clock Period | t_{SCLK} | 38 | | | ns |
| Setup Time Between Data and Rising Edge of SCLK | t_{DS} | 8 | | | ns |
| Hold Time Between Data and Rising Edge of SCLK | t_{DH} | 8 | | | ns |
| Setup Time Between Falling Edge of \overline{CS} and SCLK | t_S | 10 | | | ns |
| Hold Time Between Rising Edge of \overline{CS} and SCLK | t_H | 10 | | | ns |
| Minimum Period SCLK in a Logic High State | t_{HIGH} | 10 | | | ns |
| Minimum Period SCLK in a Logic Low State | t_{LOW} | 10 | | | ns |
| Maximum Time Delay Between Falling Edge of SCLK and Output Data Valid for a Read Operation | t_{ACCESS} | | | 231 | ns |
| Maximum Time Delay Between \overline{CS} Deactivation and SDIO Bus Return to High Impedance | t_Z | | 5 | | ns |

Timing Diagram

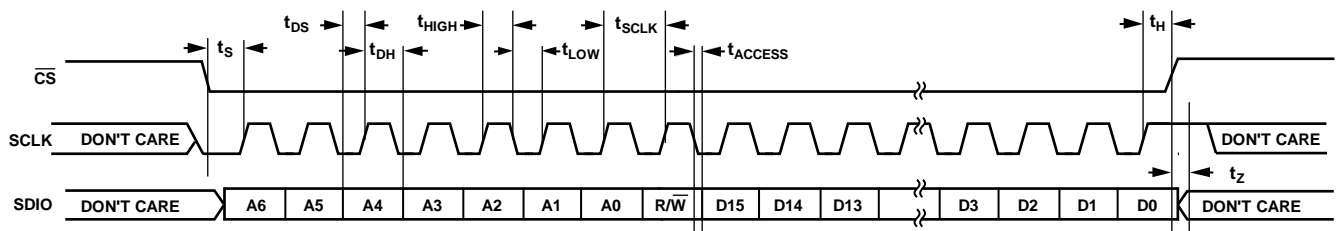

Figure 2. Setup and Hold Timing Measurements

11990-002

ABSOLUTE MAXIMUM RATINGS

Table 5.

| Parameter | Rating |
|------------------------------|------------------------|
| VPOS_5V | -0.5 V to +5.5 V |
| VPOS_3P3 | -0.3 V to +3.6 V |
| VOCM | -0.3 V to +3.6 V |
| \overline{CS} , SCLK, SDIO | -0.3 V to +3.6 V |
| RFSW | -0.3 V to +3.6 V |
| RFIN0, RFIN1 | 2.5 V peak, ac-coupled |
| ENBL | -0.3 V to +3.6 V |
| VTUNE | -0.3 V to +3.6 V |
| LOIN-, LOIN+ | 16 dBm, differential |
| REFIN | -0.3 V to +3.6 V |
| Operating Temperature Range | -40°C to +85°C |
| Storage Temperature Range | -65°C to +150°C |
| Maximum Junction Temperature | 150°C |

Stresses above those listed under Absolute Maximum Ratings may cause permanent damage to the device. This is a stress rating only; functional operation of the device at these or any other conditions above those indicated in the operational section of this specification is not implied. Exposure to absolute maximum rating conditions for extended periods may affect device reliability.

THERMAL RESISTANCE

θ_{JA} is specified for the worst-case conditions, that is, a device soldered in a circuit board for surface-mount packages.

Table 6. Thermal Resistance

| Package Type | θ_{JA} | θ_{JC} | Unit |
|---------------|---------------|---------------|------|
| 40-Lead LFCSP | 31.93 | 1.12 | °C/W |

ESD CAUTION



ESD (electrostatic discharge) sensitive device. Charged devices and circuit boards can discharge without detection. Although this product features patented or proprietary protection circuitry, damage may occur on devices subjected to high energy ESD. Therefore, proper ESD precautions should be taken to avoid performance degradation or loss of functionality.

PIN CONFIGURATION AND FUNCTION DESCRIPTIONS

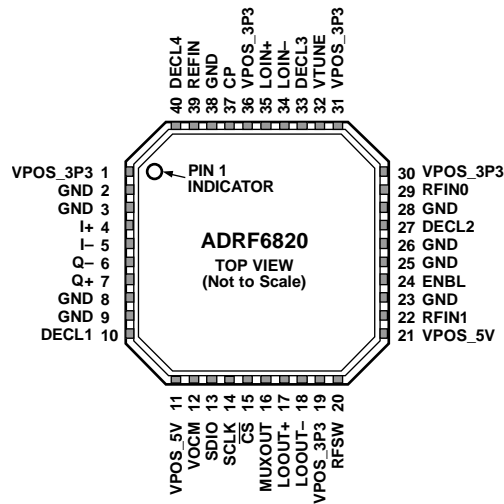

NOTES
 1. THE EXPOSED PAD MUST BE CONNECTED TO A GROUND PLANE WITH LOW THERMAL IMPEDANCE.

11990-003

Figure 3. Pin Configuration

Table 7. Pin Function Descriptions

| Pin No. | Mnemonic | Description |
|--------------------------------|-----------------|--|
| 1, 19, 30, 31, 36 | VPOS_3P3 | 3.3 V Power Supply. |
| 2, 3, 8, 9, 23, 25, 26, 28, 38 | GND | Ground. |
| 4, 5 | I+, I- | Differential Baseband Outputs, I Channel. |
| 6, 7 | Q-, Q+ | Differential Baseband Outputs, Q Channel. |
| 10 | DECL1 | Decoupling for Mixer Load. Connect a 0.22 μ F capacitor from DECL1 to GND. |
| 11, 21 | VPOS_5V | 5 V Power Supply. |
| 12 | VOCM | Reference Voltage Input. This pin sets the output common-mode level. |
| 13 | SDIO | SPI Data. |
| 14 | SCLK | SPI Clock. |
| 15 | \overline{CS} | Chip Select, Active Low. |
| 16 | MUXOUT | Mux Output. Output pin providing the PLL reference signal or the PLL lock detect. |
| 17, 18 | LOOUT+, LOOUT- | Differential LO Outputs. |
| 20 | RFSW | RF Switch Select. Selects between RFIN0 and RFIN1. |
| 22, 29 | RFIN1, RFIN0 | RF Inputs. Single pole, double throw switch input. |
| 24 | ENBL | Enable, Active High. |
| 27, 33 | DECL2, DECL3 | VCO LDO Decoupling. |
| 32 | VTUNE | VCO Tuning Voltage Input. |
| 34, 35 | LOIN-, LOIN+ | Differential LO Inputs. |
| 37 | CP | PLL Charge Pump Output. |
| 39 | REFIN | PLL Reference Input. |
| 40 | DECL4 | 2.5 V LDO Decoupling. |
| | EPAD | Exposed Pad. The exposed pad must be connected to a ground plane with low thermal impedance. |

TYPICAL PERFORMANCE CHARACTERISTICS

VPOS_5V = 5 V, VPOS_3P3 = 3.3 V, RFDSA_SEL = 0, RFSW = 0 (RFIN0), high-side LO, -5 dB per tone for two-tone measurement with 5 MHz tone spacing, unless otherwise noted. For BWSEL0, $f_{IF} = 40$ MHz, and for BWSEL2, $f_{IF} = 200$ MHz. For BAL_CIN, BAL_COUT, MIX_BIAS, DEMOD_RDAC, and DEMOD_CDAC, refer to Table 16.

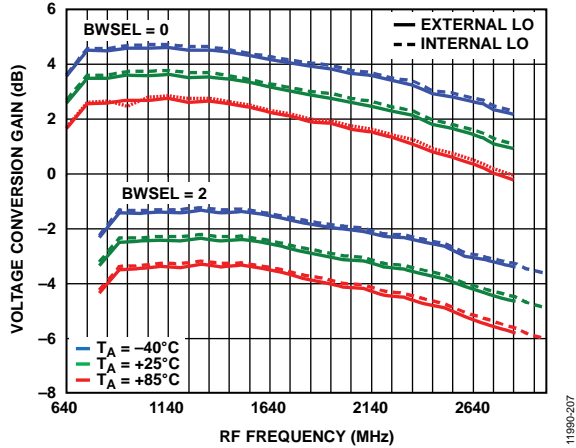

Figure 4. Voltage Conversion Gain vs. RF Frequency over Temperature

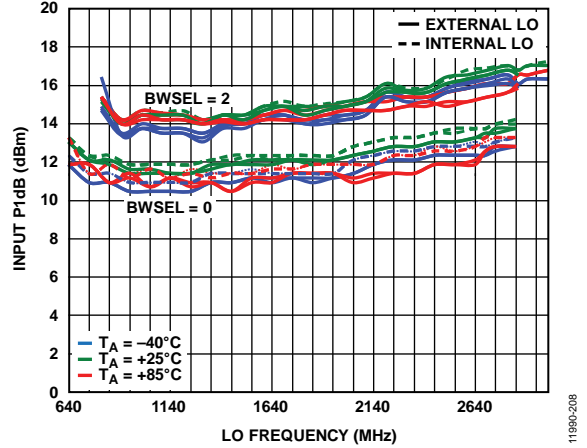

Figure 7. Input P1 dB vs. LO Frequency

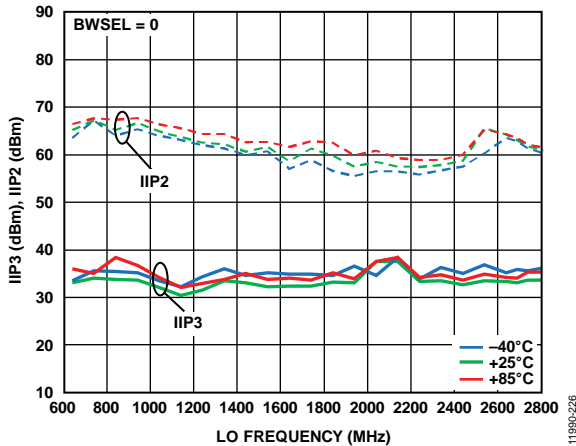

Figure 5. Input IP3 (IIP3) and Input IP2 (IIP2) vs. LO Frequency over Temperature, BWSEL = 0

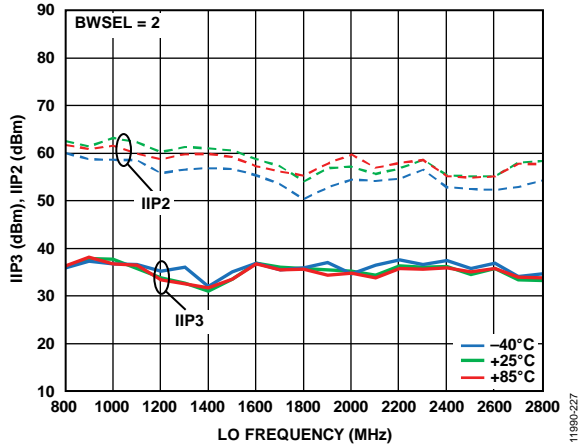

Figure 8. Input IP3 (IIP3) and Input IP2 (IIP2) vs. LO Frequency over Temperature, BWSEL = 2

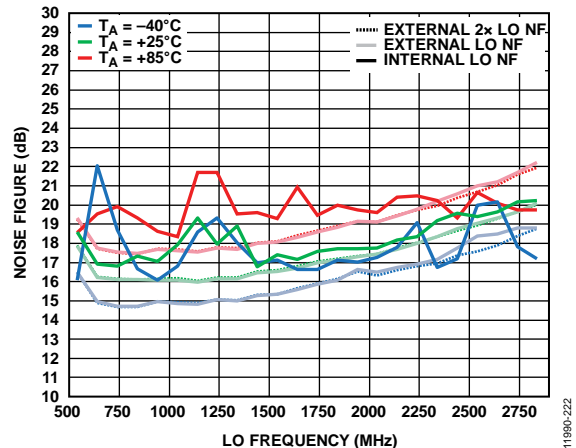

Figure 6. Noise Figure vs. LO Frequency, BWSEL = 0

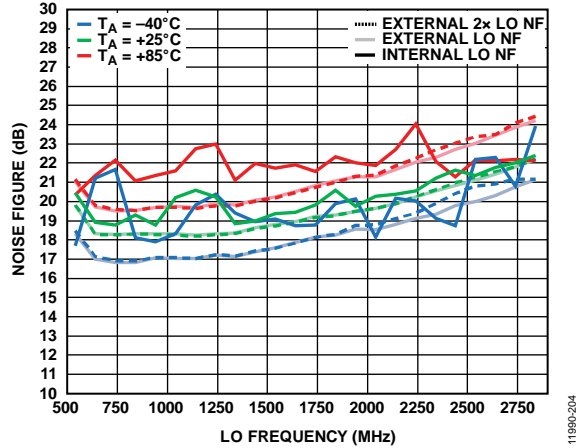

Figure 9. Noise Figure vs. LO Frequency, BWSEL = 2

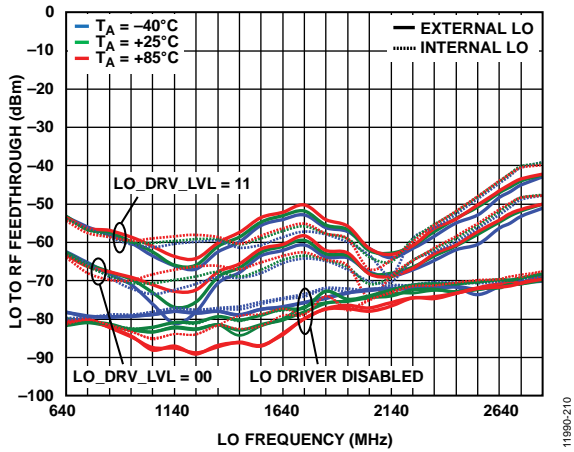

Figure 10. LO to RF Feedthrough vs. LO Frequency

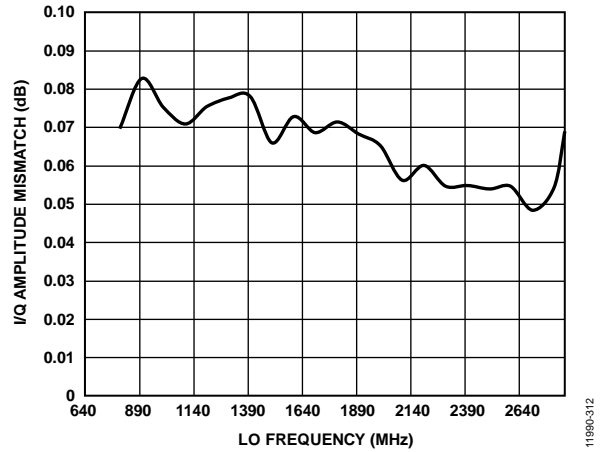

Figure 13. I/Q Amplitude Mismatch vs. LO Frequency

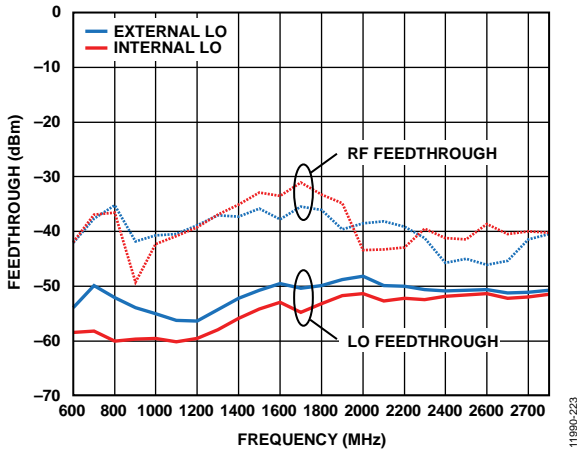

Figure 11. RF and LO Feedthrough to IF Output, RF Input -5 dBm

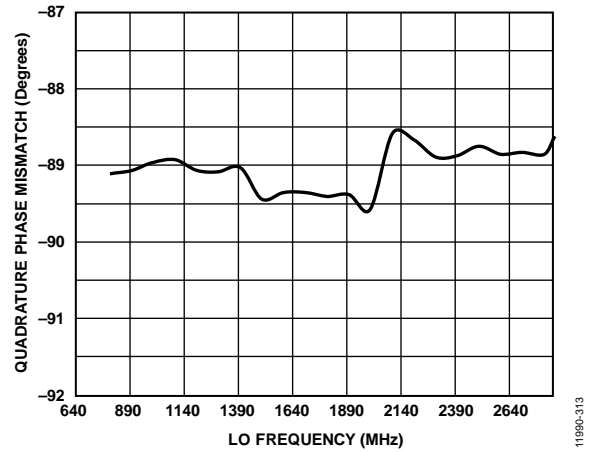

Figure 14. Quadrature Phase Mismatch vs. LO Frequency

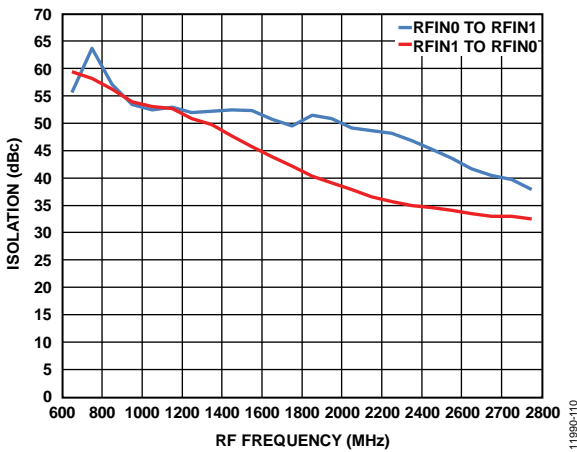

Figure 12. Switch Isolation vs. RF Frequency

11990-210

11990-312

11990-223

11990-313

11990-110

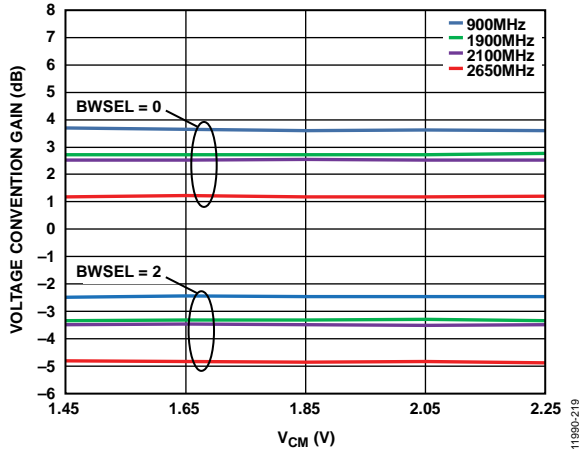

Figure 15. Gain vs. Common-Mode Voltage (V_{CM}) for $f_{RF} = 900$ MHz, $f_{RF} = 1900$ MHz, $f_{RF} = 2100$ MHz, and $f_{RF} = 2650$ MHz for $BWSEL = 0$ and $BWSEL = 2$

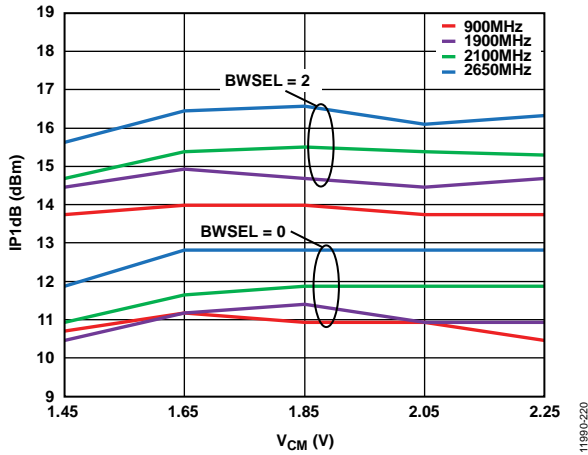

Figure 16. Input P1dB (IP1dB) vs. Common-Mode Voltage (V_{CM}) for $f_{RF} = 900$ MHz, $f_{RF} = 1900$ MHz, $f_{RF} = 2100$ MHz, and $f_{RF} = 2650$ MHz

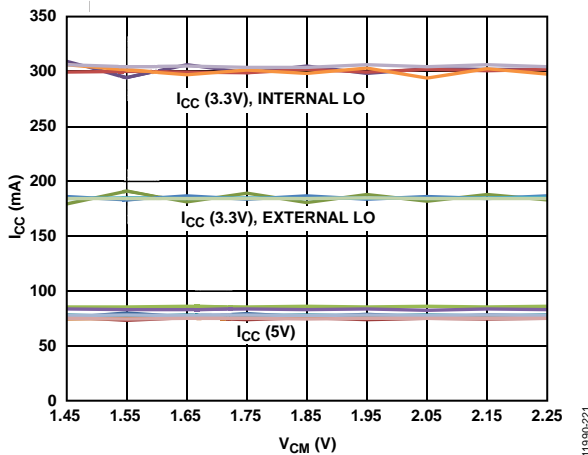

Figure 17. Current Consumption (I_{CC}) vs. Common-Mode Voltage (V_{CM}), Internal and External LO, $f_{RF} = 900$ MHz, $f_{RF} = 1900$ MHz, $f_{RF} = 2100$ MHz, $f_{RF} = 2100$ MHz, and $f_{RF} = 2650$ MHz

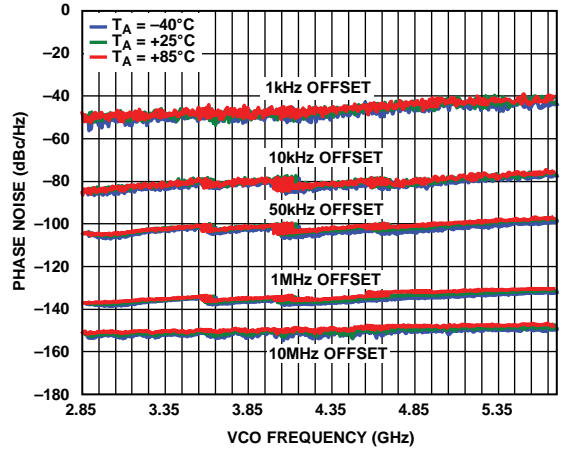

Figure 18. Open-Loop Phase Noise for 1 kHz, 10 kHz, 50 kHz, 1 MHz, and 10 MHz Offsets

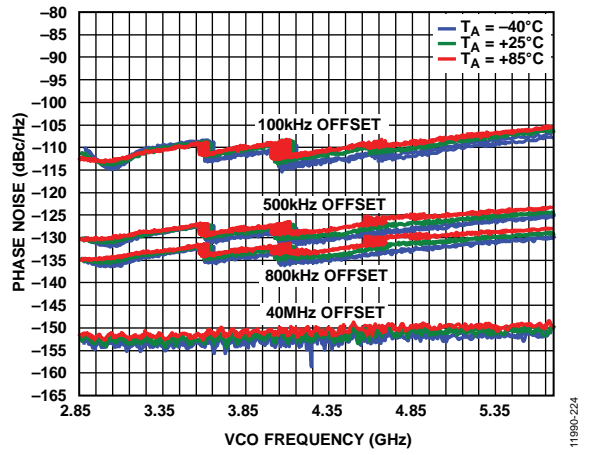

Figure 19. Open-Loop Phase Noise for 100 kHz, 500 kHz, 800 kHz, and 40 MHz Offsets

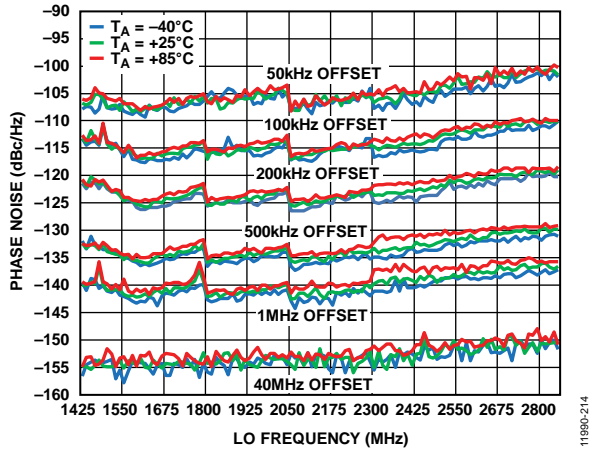

Figure 20. Closed-Loop Phase Noise vs. LO Frequency, 20 kHz Bandwidth Loop Filter, Measured with $DIV4_EN = 1$ (Divide by 2)

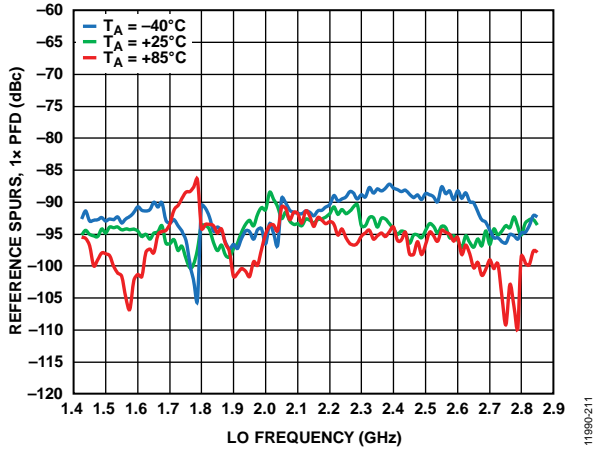

Figure 21. 1x PFD Spurs vs. LO Frequency, Measured with DIV4_EN = 1 (Divide by 2)

11990-211

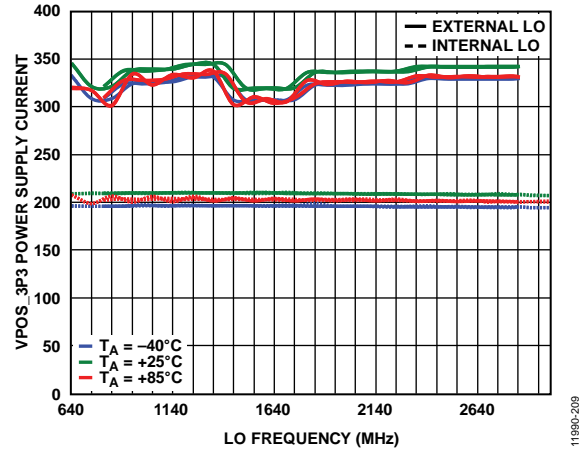

Figure 24. VPOS_3P3 Power Supply Current vs. LO Frequency

11990-209

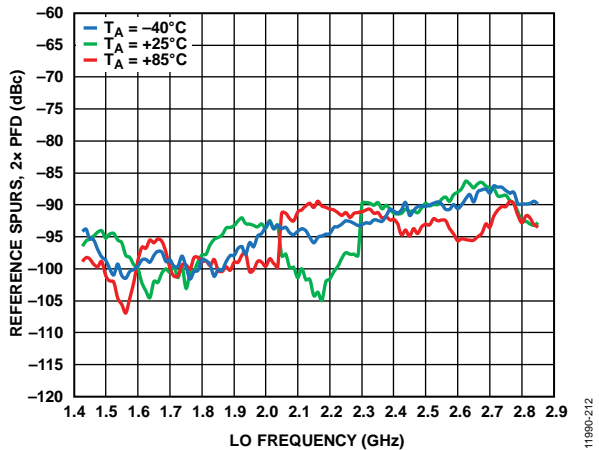

Figure 22. 2x PFD Spurs vs. LO Frequency, Measured with DIV4_EN = 1 (Divide by 2)

11990-212

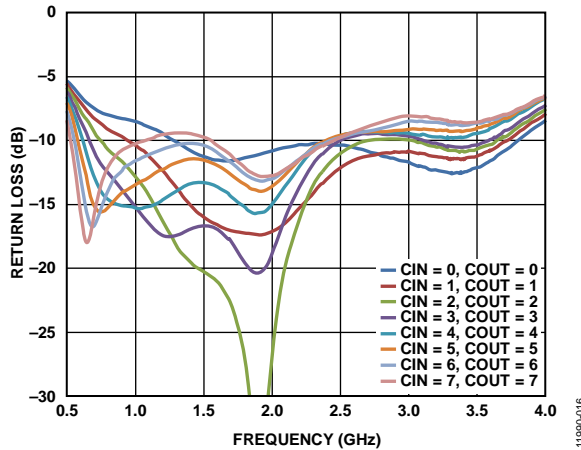

Figure 25. RFIN0/RFIN1 Return Loss for Multiple BAL_CIN and BAL_COUT Combinations

11990-016

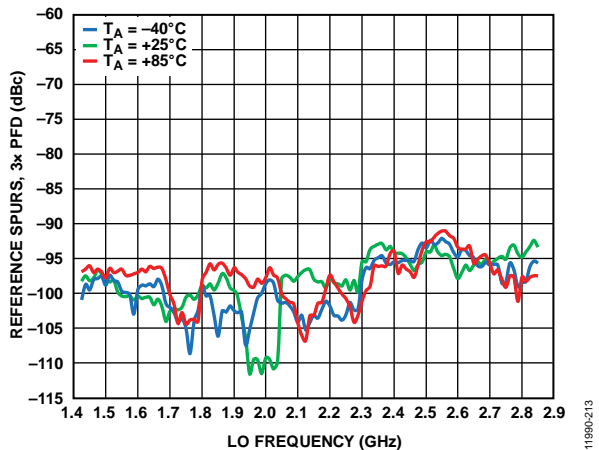

Figure 23. 3x PFD Spurs vs. LO Frequency, Measured with DIV4_EN = 1 (Divide by 2)

11990-213

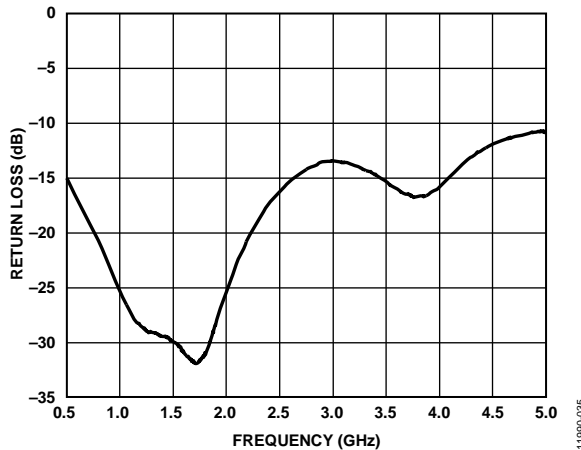

Figure 26. Return Loss of Unused RFINx Port vs. Frequency

11990-035

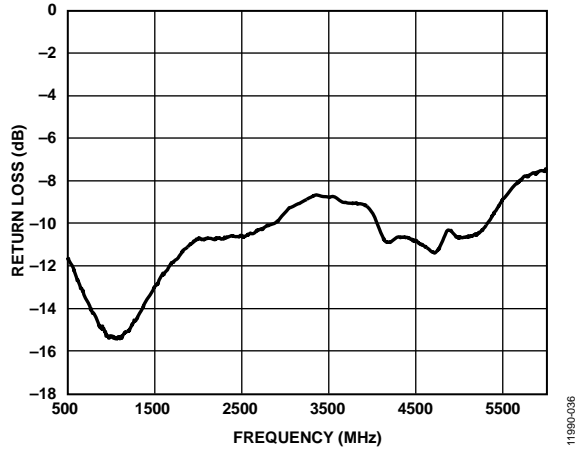

Figure 27. LO Input Return Loss vs. Frequency

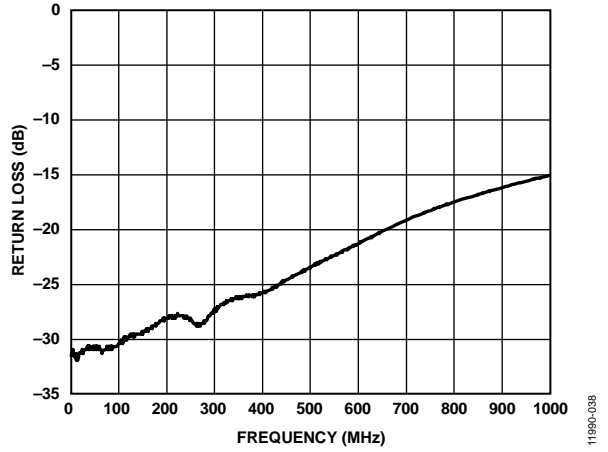

Figure 29. I/Q Return Loss vs. Frequency

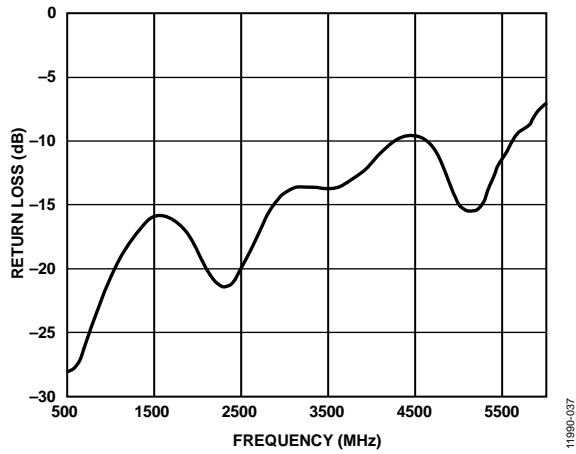

Figure 28. LO Output Return Loss vs. Frequency

11990-036

11990-038

11990-037

THEORY OF OPERATION

The **ADRF6820** integrates many of the essential building blocks for a high bandwidth quadrature demodulator and receiver, especially for the feedback downconverter path for the digital predistortion in cellular base stations. The main features include a single pole, double throw (SPDT) RF input switch, a variable RF attenuator, a tunable balun, a pair of active mixers, and two baseband buffers. Additionally, the local oscillator (LO) signals for the mixers are generated by a fractional-N synthesizer and a multicore voltage controlled oscillator (VCO), covering an octave frequency range with low phase noise. A pair of flip-flops then divides the LO frequency by two and generates the in-phase and quadrature phase LO signals to drive the mixers. The synthesizer uses a fractional-N phase-locked loop (PLL) with additional frequency dividers to enable continuous LO coverage from 356.25 MHz to 2850 MHz. Alternatively, a polyphase phase splitter is also available to generate LO signals in quadrature from an external LO source.

Putting all the building blocks of the **ADRF6820** together, the signal path through the device starts at one of two RF inputs selected by the input multiplexer (mux) and is converted to a differential signal via a tunable balun. The differential RF signal is attenuated to an optimal input level via the digital step attenuator with 15 dB of attenuation range in 1 dB steps. The RF signal is then mixed with the LO signal in the Gilbert cell mixers down to an intermediate frequency (IF) or baseband. The emitter followers further buffer the outputs of the mixers with an adjustable output common-mode level.

The different sections of the **ADRF6820** are controlled through registers programmable via a serial port interface (SPI).

RF INPUT SWITCH

The **ADRF6820** integrates a SPDT switch where one of two RF inputs is selected. Selection of the desired RF input is achieved externally via a control pin or serially via register writes to the SPI. When compared to the serial write approach, pin control allows faster switching between the RF inputs. Using the RFSW pin (Pin 20), the RF input can switch within 100 ns. When serial port control is used, the switching time is dominated by the latency of the SPI programming, which is 2.4 μ s minimum for a 10 MHz serial clock.

The RFSW_MUX bit (Register 0x23, Bit 11) selects whether the RF input switch is controlled via the external pins or via the SPI (see Table 8). By default at power-up, the device is configured for pin control. Connecting RFSW to GND selects RFIN0, and

connecting RFSW to VPOS_3P3 selects RFIN1. In serial mode control, writing to the RFSW_SEL bit (Register 0x23, Bit 9) allows selection of one of the two RF inputs. If only one RFINx port is used, the unused RF input must be properly terminated to improve isolation. The RFIN0/REFIN1 ports are internally terminated with 50 Ω resistors, and the dc level is 2.5 V. To avoid disrupting the dc level, the recommended termination is a dc blocking capacitor to GND. Figure 30 shows the recommended configuration when only RFIN0 is selected.

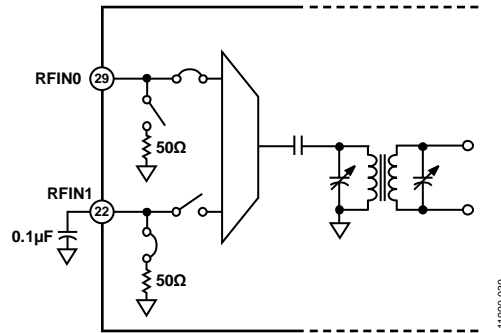

Figure 30. Terminating Unused RF Input Ports

TUNABLE BALUN

The **ADRF6820** integrates a programmable balun operating over a 695 MHz to 2700 MHz frequency range. The tunable balun offers the benefit of ease of drivability with single-ended, 50 Ω RF inputs, and the single-ended-to-differential conversion of the integrated balun provides additional common-mode noise rejection.

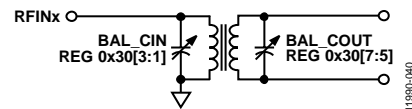

Figure 31. Integrated Tunable Balun

To accomplish RF balun tuning, switch the parallel capacitances on the primary and secondary sides of the balun by writing to Register 0x30. The added capacitance in parallel with the inductive windings of the balun changes the resonant frequency of the inductor capacitor (LC) tank. Therefore, selecting the proper combination of BAL_CIN (Register 0x30, Bits[3:1]) and BAL_COUT (Register 0x30, Bits[7:5]) sets the desired frequency and optimizes gain. Under most circumstances, the input and output capacitances are tuned together; however, sometimes for matching reasons, it is advantageous to tune them independently.

Table 8. RF Input Selection Table

| RFSW_MUX (Register 0x23, Bit 11) | RFSW_SEL SPI Control (Register 0x23, Bit 9) | RFSW Pin Control (Pin 20) | RF Input |
|----------------------------------|---|---------------------------|----------|
| 0 | 0 | X ¹ | RFIN0 |
| 0 | 1 | X ¹ | RFIN1 |
| 1 | X ¹ | 0 | RFIN0 |
| 1 | X ¹ | 1 | RFIN1 |

¹ X = don't care.

RF ATTENUATOR

The RF digital step attenuator (RFDSA) follows the tunable balun, and the attenuation range is 0 dB to 15 dB with a step size of 1 dB. The RFDSA_SEL bits (Register 0x23, Bits[8:5]) in the DGA_CTL register determines the setting of the RFDSA.

LO GENERATION BLOCK

The ADRF6820 supports the use of both internal and external LO signals for the mixers. The internal LO is generated by an on-chip VCO, which is tunable over an octave frequency range of 2850 MHz to 5700 MHz. The output of the VCO is phase locked to an external reference clock through a fractional-N PLL that is programmable through the SPI control registers. To produce in-phase and quadrature phase LO signals over the 356.25 to 2850 MHz frequency range to drive the mixers, steer the VCO outputs through a combination of frequency dividers, as shown in Figure 32.

Alternatively, an external signal can be used with the dividers or a polyphase phase splitter to generate the LO signals in quadrature to the mixers. In demanding applications that require the lowest possible phase noise performance, it may be necessary to source the LO signal externally. The different methods in quadrature LO generation and the control register programming needed are listed in Table 9.

Internal LO Mode

For internal LO mode, the ADRF6820 uses the on-chip PLL and VCO to synthesize the frequency of the LO signal. The PLL, shown in Figure 32, consists of a reference path, phase and frequency detector (PFD), charge pump, and a programmable integer divider with prescaler. The reference path takes in a reference clock and divides it down by a factor of 2, 4, or 8 or multiplies it by a factor of 1 or a factor of 2, and then passes it to the PFD. The PFD compares this signal to the divided down signal from the VCO. Depending on the PFD polarity selected, the PFD sends an up/down signal to the charge pump if the VCO signal is slow/fast compared to the reference frequency. The charge pump sends a current pulse to the off-chip loop filter to increase or decrease the tuning voltage (VTUNE). The charge pump sends a current pulse to the off-chip loop filter to increase or decrease the tuning voltage (VTUNE).

The ADRF6820 integrates four VCO cores covering an octave range of 2.85 GHz to 5.7 GHz.

Table 9 lists the frequency range covered by each VCO. The desired VCO can be selected by addressing the VCO_SEL bits (Register 0x22, Bits[2:0]).

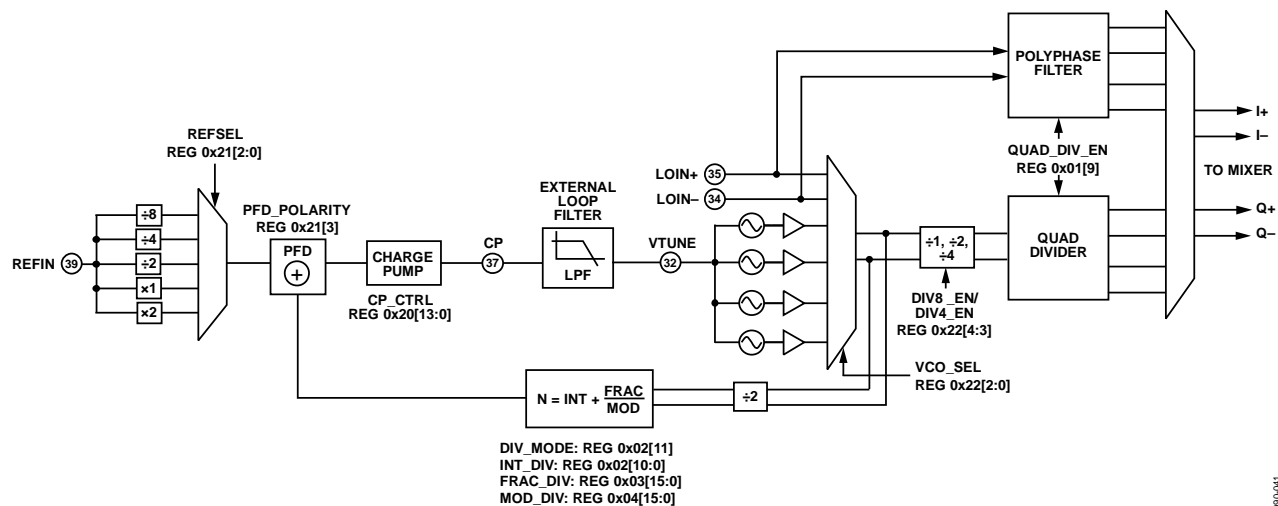

Figure 32. LO Generation Block Diagram

Table 9. LO Mode Selection

| LO Selection | f _{VCO} or f _{EXT} (GHz) | Quadrature Generation | QUAD_DIV_EN, Register 0x01[9] | LO Enables, Register 0x01[6:0] | VCO_SEL, Register 0x22[2:0] |
|------------------|--|-----------------------|-------------------------------|--------------------------------|-----------------------------|
| Internal (VCO) | 2.85 to 3.5 | Divide by 2 | 1 | 111 111X | 011 |
| | 3.5 to 4.02 | Divide by 2 | 1 | 111 111X | 010 |
| | 4.02 to 4.6 | Divide by 2 | 1 | 111 111X | 001 |
| | 4.6 to 5.7 | Divide by 2 | 1 | 111 111X | 000 |
| External (2× LO) | 0.7 to 6.0 | Divide by 2 | 1 | 101 000X | 1XX |
| External (1× LO) | 0.35 to 3.5 | Polyphase | 0 | 000 000X | XXX |

LO Frequency and Dividers

The signal coming from the VCO or the external LO inputs goes through a series of dividers before it is buffered to drive the active mixers. Two programmable divide-by-two stages divide the frequency of the incoming signal by 1, 2, or 4 before reaching the quadrature divider that further divides the signal frequency by two to generate the in-phase and quadrature-phase LO signals for the mixers. The control bits (Register 0x22, Bits[4:3]) needed to select the different LO frequency ranges are listed in Table 10.

Table 10. LO Frequency and Dividers

| LO Frequency Range (MHz) | f_{VCO}/f_{LO} or f_{EXTLO}/f_{LO} | DIV8_EN (Register 0x22, Bit 4) | DIV4_EN (Register 0x22, Bit 3) |
|--------------------------|--|--------------------------------|--------------------------------|
| 1425 to 2850 | 2 | 0 | 0 |
| 712.5 to 1425 | 4 | 0 | 1 |
| 356.25 to 712.5 | 8 | 1 | 1 |

PLL Frequency Programming

The N divider divides down the differential VCO signal to the PFD frequency. The N divider can be configured for fractional or integer mode by addressing the DIV_MODE bit (Register 0x02, Bit 11). The default configuration is set for fractional mode. Use the following equations to determine the N value and PLL frequency:

$$f_{PFD} = \frac{f_{VCO}}{2 \times N}$$

$$N = INT + \frac{FRAC}{MOD}$$

$$f_{LO} = \frac{f_{PFD} \times 2 \times N}{LO_DIVIDER}$$

where:

f_{PFD} is the phase frequency detector frequency.

f_{VCO} is the VCO frequency.

N is the fractional divide ratio ($INT + FRAC/MOD$).

INT is the integer divide ratio programmed in Register 0x02.

FRAC is the fractional divider programmed in Register 0x03.

MOD is the modulus divide ratio programmed in Register 0x04.

f_{LO} is the LO frequency going to the mixer core when the loop is locked.

LO_DIVIDER is the final frequency divider ratio that divides the frequency of the VCO or the external LO signal down by 2, 4, or 8 before it reaches the mixer, as shown in Table 10.

PLL Lock Time

The time it takes to lock the PLL after the last register is written breaks down into two parts: VCO band calibration and loop settling.

After writing to the last register, the PLL automatically performs a VCO band calibration to choose the correct VCO band. This calibration takes approximately 94,208 PFD cycles. For a 40 MHz f_{PFD} , this corresponds to 2.36 ms. After calibration completes, the feedback action of the PLL causes the VCO to lock to the correct frequency eventually. The speed with which this lock occurs depends on the nonlinear cycle slipping behavior, as well as the small signal settling of the loop. For an accurate estimation of the lock time, download the [ADIsimPLL tool](#) to capture these effects correctly. In general, higher bandwidth loops tend to lock more quickly than lower bandwidth loops.

The lock detect signal is available as one of the selectable outputs through the MUXOUT pin, with a logic high signifying that the loop is locked. The control for the MUXOUT pin is located in the REF_MUX_SEL bits (Register 0x21, Bits[6:4]), and the default configuration is for PLL lock detect.

Buffered LO Outputs

A buffered version of the internal LO signal is available differentially at the LOOUT+ and LOOUT– pins (Pin 17 and Pin 18). When the quadrature LO signals are generated using the quadrature divider, the output signal is available at either 2× or 1× the frequency of the LO signal at the mixer. Set the output to different drive levels by accessing the LO_DRV_LVL bits (Register 0x22, Bits[7:6]), as shown in Table 11.

The availability of the LO signal makes it possible to daisy-chain many devices synchronously. One ADRF6820 device can serve as the master where the LO signal is sourced, and the subsequent slave devices share the same LO output signal from the master. This flexibility substantially eases the LO requirements of a system requiring multiple LOs.

Table 11. LO Output Level

| LO_DRV_LVL (Register 0x22, Bits[7:6]) | Amplitude (dBm) | DC Level (V) |
|---------------------------------------|-----------------|--------------|
| 00 | –5 | 3.0 |
| 01 | –1 | 2.85 |
| 10 | +2 | 2.7 |
| 11 | +4 | 2.5 |

External LO Mode

Use the VCO_SEL bits (Register 0x22, Bits[2:0]) to select external or internal LO mode. To configure for external LO mode, set Register 0x22, Bits[2:0] to 4 (decimal) and apply the differential LO signals to Pin 34 (LOIN–) and Pin 35 (LOIN+). The external LO frequency range is 350 MHz to 6 GHz. When the polyphase phase splitter is selected, a 1×LO signal is required for the active mixer, or a 2×LO can be used with the internal quadrature divider, as shown in Table 9.

The LOIN+ and LOIN– input pins must be ac-coupled. When not in use, leave the LOIN+ and LOIN– pins unconnected.

Required PLL/VCO Settings and Register Write Sequence

In addition to writing to the necessary registers to configure the PLL and VCO for the desired LO frequency and phase noise performance, the registers in Table 12 are required register writes.

To ensure that the PLL locks to the desired frequency, follow the proper write sequence of the PLL registers. Configure the PLL registers accordingly to achieve the desired frequency, and the last writes must be to Register 0x02 (INT_DIV), Register 0x03 (FRAC_DIV), or Register 0x04 (MOD_DIV). When Register 0x02, Register 0x03, and Register 0x04 are programmed, an internal VCO calibration initiates, which is the last step to locking the PLL.

Table 12. Required PLL/VCO Register Writes

| Address[Bits] | Bit Name | Setting | Description |
|---------------|---------------------------|---------|-------------------|
| 0x21[3] | PFD_POLARITY | 0x1 | Negative polarity |
| 0x49[15:0] | RESERVED, SET_1, SET_0 | 0x14B4 | Internal settings |

ACTIVE MIXERS

The signal from the RFDSA is split to drive a pair of double balanced, Gilbert cell active mixers, to be downconverted by the LO signals to baseband. Program the current in the mixers by changing the value of the MIX_BIAS bits (Register 0x31, Bits[12:10]) for trade-off between output noise and linearity.

The active mixers employ a distortion correction circuit for cancelling the third-order distortions coming from the mixers. Determine the amplitude and phase of the correction signals by the combination of control register entries DEMOD_RDAC and DEMOD_CDAC (Register 0x31, Bits[8:5] and Register 0x31, Bits[3:0], respectively). Refer to the IP3 and Noise Figure Optimization section for more information.

Demodulator gain and bandwidth are set by the resistance and capacitance in the mixer loads, which are controlled by the BWSEL bits (Register 0x34, Bits[9:8]) according to Table 15. Refer to the Bandwidth Select Modes for more information

BASEBAND BUFFERS

Emitter followers buffer the signals at the mixer loads and drive the baseband output pins (I+, I-, Q-, and Q+). Bias currents of the emitter followers are controlled by the BB_BIAS bits (Register 0x34, Bits[11:10]), as shown in Table 13. Set the bias current according to the load driving capabilities needed (that is, BB_BIAS = 1 for the specified 200 Ω load, and BB_BIAS = 2 for the 50 Ω or 100 Ω loads are recommended). The differential impedance of the baseband outputs is 50 Ω ; however, the ADRF6820 output load must be high (that is, 200 Ω) for optimized linearity performance. Refer to the I/Q Output Loading section for supporting data.

Table 13. Baseband Buffer Bias

| BB_BIAS (Register 0x34, Bits[11:10]) | Bias Current (mA) |
|--------------------------------------|-------------------|
| 00 | 0 |
| 01 | 4.5 |
| 10 | 9 |
| 11 | 13.5 |

SERIAL PORT INTERFACE (SPI)

The SPI of the ADRF6820 allows the user to configure the device for specific functions or operations through a structured register space provided inside the chip. This interface provides users with added flexibility and customization. Addresses are accessed via the serial port interface and can be written to or read from via the serial port interface.

The serial port interface consists of three control lines: SCLK, SDIO, and \overline{CS} . SCLK (serial clock) is the serial shift clock, and it synchronizes the serial interface reads and writes. SDIO is the serial data input or the serial data output depending on the instruction sent and the relative position in the timing frame. \overline{CS} (chip select bar) is an active low control that gates the read and write cycles. The falling edge of \overline{CS} in conjunction with the rising edge of SCLK determines the start of the frame. When \overline{CS} is high, all SCLK and SDIO activity is ignored. See Table 4 for the serial timing and its definitions.

The ADRF6820 protocol consists of seven register address bits, followed by a read/write and 16 data bits. Both the address and data fields are organized with the most significant bit (MSB) first and end with the least significant bit (LSB).

On a write cycle, up to 16 bits of serial write data is shifted in, MSB to LSB. If the rising edge of \overline{CS} occurs before the LSB of the serial data is latched, only the bits that were latched are written to the device. If more than 16 data bits are shifted in, the 16 most recent bits are written to the device. The ADRF6820 input logic level for the write cycle supports an interface as low as 1.8 V.

On a read cycle, up to 16 bits of serial read data is shifted out, MSB first. Data shifted out beyond 16 bits is undefined. Read back content at a given register address does not necessarily correspond with the write data of the same address. The output logic level for a read cycle is 2.5 V.

APPLICATIONS INFORMATION

BASIC CONNECTIONS

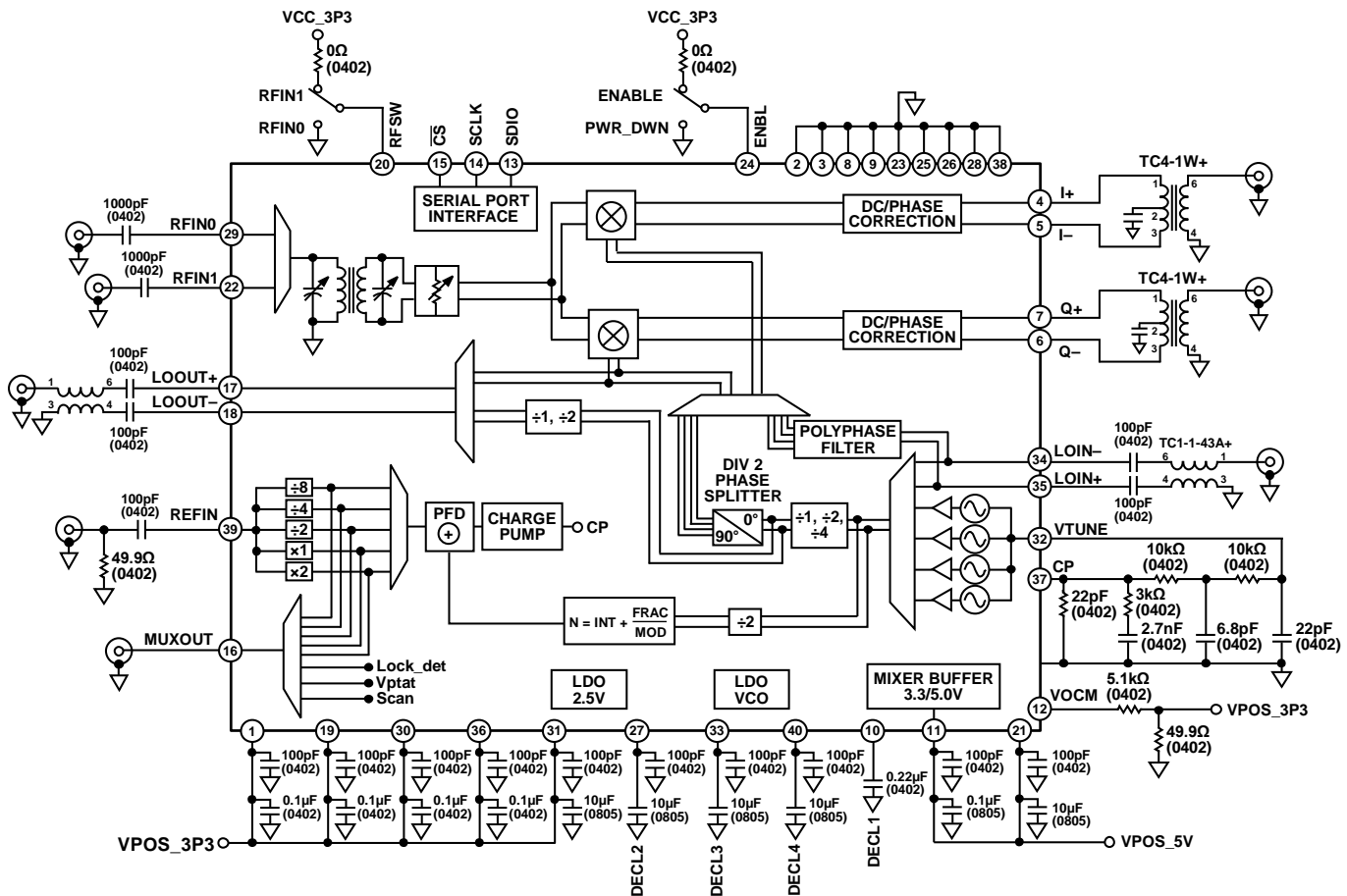

Figure 33. Basic Connections

Table 14.

| Pin No. | Mnemonic | Description | Basic Connection |
|--------------------|-----------|---------------------------|---|
| 5 V Power | | | |
| 11 | VPOS_5V | Mixer power supply | Decouple this power supply pins via a 100 pF and a 0.1 μF capacitor to ground. Ensure that the decoupling capacitors are located close to the pin. |
| 21 | VPOS_5V | RF front-end power supply | Decouple this power supply pin via a 100 pF and a 10 μF (0805) capacitor to ground. Ensure that the decoupling capacitors are located close to the pin. |
| 3.3 V Power | | | |
| 1 | VPOS_3P3V | Digital power supply | Decouple this pin via a 100 pF and a 0.1 μF capacitor to ground. |
| 19 | VPOS_3P3V | LO power supply | Decouple this pin via a 100 pF and a 0.1 μF capacitor to ground. |
| 30 | VPOS_3P3V | LO power supply | Decouple this pin via a 100 pF and a 0.1 μF capacitor to ground. |
| 31 | VPOS_3P3V | VCO power supply | Decouple this pin via a 100 pF and a 10 μF capacitor to ground. |
| 36 | VPOS_3P3V | PLL power supply | Decouple this pin via a 100 pF and a 0.1 μF capacitor to ground. |

| Pin No. | Mnemonic | Description | Basic Connection |
|--|--|---|---|
| PLL/VCO 37 | CP | Synthesizer charge pump output voltage | Connect to the VTUNE pin through the loop filter. |
| 39 | REFIN | Synthesizer reference frequency input | Nominal input level is 1 V p-p. Input range is 12 MHz to 320 MHz. This pin is internally biased to VPOS_3P3V/2 and must be ac-coupled. |
| 17, 18 | LOOUT+, LOOUT- | Differential LO outputs | The differential output impedance is 50 Ω. These pins are internally biased and must be ac-coupled. The dc level varies with LO output drive level. See Table 11. |
| 34, 35 | LOIN-, LOIN+ | Differential LO inputs | Differential input impedance of 50 Ω. These pins are internally biased and must be ac-coupled. |
| 16 | MUXOUT | PLL multiplex output | This output pin provides the PLL reference signal or the PLL lock detect signal. |
| 32 | VTUNE | VCO tuning voltage | This pin is driven by the output of the loop filter, and the nominal input voltage range is 1 V to 2.8 V. |
| RF Inputs 22, 29 | RFIN1, RFIN0 | RF inputs | The single-ended RF inputs have a 50 Ω input impedance. These pins are internally biased to VPOS_5V/2. AC couple the RF inputs. Refer to the Layout section for the recommended printed circuit board (PCB) layout for improved channel-to-channel isolation. Terminate unused RF inputs with a dc blocking capacitor to GND to improve on isolation. |
| 20 | RFSW | Pin control of the RF inputs | For RFIN0, set RFSW to logic low, and for RFIN1, set RFSW to logic high. For logic high, connect the pin to 2.5 V. |
| Demodulator Outputs 4, 5, 6, 7 | I+, I-, Q-, Q+ | I and Q channel mixer baseband outputs | The I and Q mixer outputs have a 50 Ω differential output impedance (25 Ω per pin). The VOCM pin sets the output common-mode level. |
| 12 | VOCM | Mixer output common-mode voltage | The input pin sets the common-mode voltage of the I and Q complex outputs. VOCM needs a clean voltage source within the 1.5 V to 2.4 V range. Linearity performance degrades when the voltage is outside this range. |
| Enable 24 | ENBL | External enable pin control | Set this pin high for enable and low for power-down of the internal blocks. To specify the internal blocks, write to Register 0x10, power-down mask. |
| Serial Port Interface 13 14 15 | SDIO SCLK $\overline{\text{CS}}$ | SPI data input and output SPI clock SPI chip select | 3.3 V tolerant logic levels. 3.3 V tolerant logic levels. Active low. 3.3 V tolerant logic levels. |
| LDO Decoupling 10 | DECL1 | Mixer LDO decoupling | Decouple this pin via 0.22 μF capacitor to ground. Ensure the decoupling capacitor is located close to the pin. |
| 27 | DECL2 | VCO2 LDO decoupling | Decouple this power supply pin via 100 pF and 10 μF (0805) capacitors to ground. Ensure that the decoupling capacitors are located close to the pin. |
| 33 | DECL3 | VCO LDO decoupling | Decouple this power supply pin via 100 pF and 10 μF (0805) capacitors to ground. Ensure that the decoupling capacitors are located close to the pin. |
| 40 | DECL4 | 2.5V LDO decoupling | Decouple this power supply pin via 100 pF and 10 μF capacitors to ground. Ensure that the decoupling capacitors are located close to the pin. |
| GND 2, 3, 8, 9, 23, 25, 26, 28, 38 | GND | Ground | Connect these pins to the GND of PCB. |
| (EPAD) | | Exposed pad (EPAD) | The exposed thermal pad is on the bottom of the package. Solder the exposed pad to ground. |

RF BALUN INSERTION LOSS OPTIMIZATION

As shown in Figure 34 to Figure 37, the gain of the ADRF6820 mixer was characterized for every combination of BAL_CIN and BAL_COUT (Register 0x30, Bits[7:0]). As shown, a range of BAL_CIN and BAL_COUT values can be used to optimize the gain of the ADRF6820. The optimized values do not change with temperature. After the values are chosen, the absolute gain changes over temperature; however, the signature of the BAL_CIN and BAL_COUT values is fixed.

At lower input frequencies, more capacitance is needed. This capacitance increase is achieved by programming higher codes into BAL_CIN and BAL_COUT. At higher frequencies, less capacitance is required; therefore, lower BAL_CIN and BAL_COUT codes are appropriate. Figure 38 shows the change in gain over frequency for various BAL_CIN and BAL_COUT codes. Use Figure 34 to Figure 38 only as guides; do not interpret them in the absolute sense because every application and PCB design vary. Additional fine-tuning may be necessary to achieve the maximum gain. Table 16 shows the recommended BAL_CIN and BAL_COUT settings for various RF frequencies.

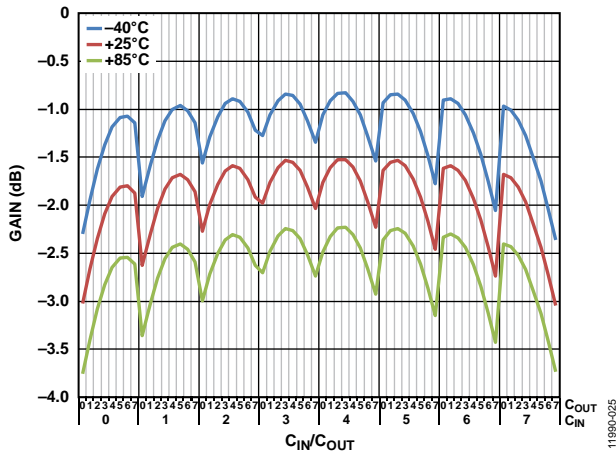

Figure 34. Gain vs. BAL_CIN and BAL_COUT at $f_{RF} = 900$ MHz

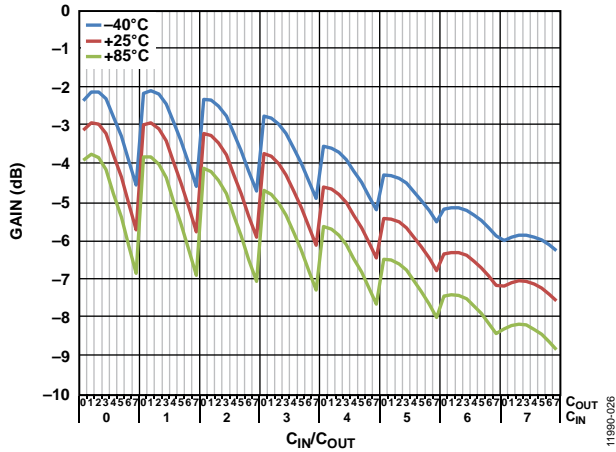

Figure 35. Gain vs. BAL_CIN and BAL_COUT at $f_{RF} = 2200$ MHz

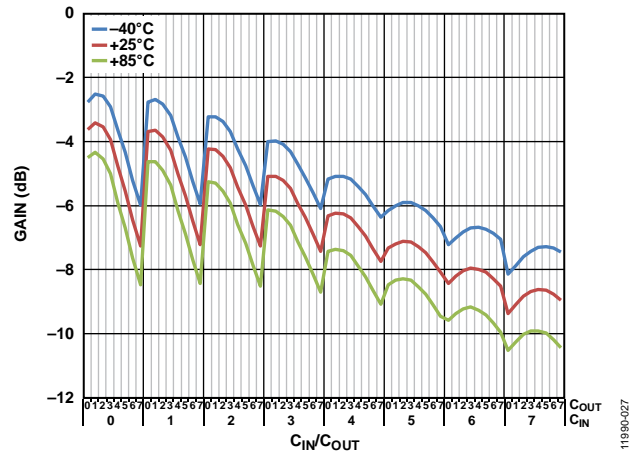

Figure 36. Gain vs. BAL_CIN and BAL_COUT at $f_{RF} = 1900$ MHz

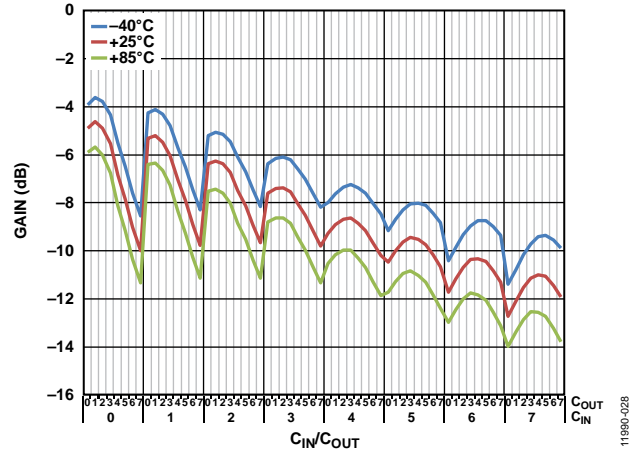

Figure 37. Gain vs. BAL_CIN and BAL_COUT at $f_{RF} = 2600$ MHz

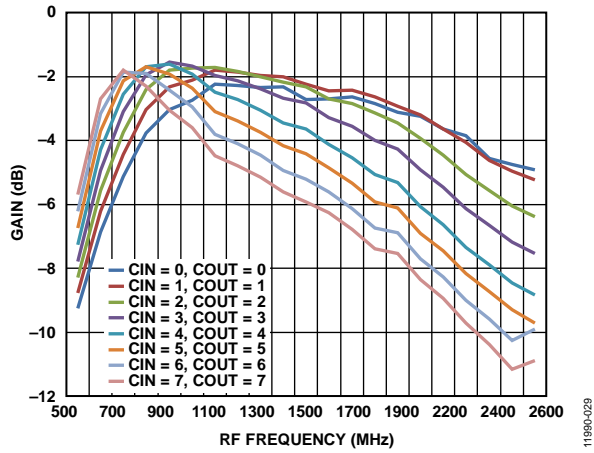

Figure 38. Gain vs. RF Frequency for Various BAL_CIN and BAL_COUT Codes

BANDWIDTH SELECT MODES

The ADRF6820 offers four bandwidth select modes, as specified in Table 15. The bandwidth select modes include either high gain and low bandwidth or low gain and high bandwidth. It is the selection of the resistance and capacitance in the mixer load that determines the IF gain and bandwidth. Use Register 0x34, Bits[9:8] to select one of the four modes.

The high gain modes, BWSEL0 and BWSEL1, have equivalent performance in terms of gain, noise figure, and linearity. Similarly, the low gain modes, BWSEL2 and BWSEL3, share the same performance specifications. However, the factor that distinguishes the different modes is the IF bandwidth. Figure 39 to Figure 42 show the voltage gain, pass-band flatness, and 1 dB bandwidth of the bandwidth modes for the various LO frequencies. Table 15 summarizes the results of Figure 39 to Figure 42.

Table 15. Mixer Gain and Bandwidth Select Modes¹

| BWSEL (Reg. 0x34[9:8]) | Mode | Voltage Gain (dB) | 1 dB BW (MHz) | 3 dB BW (MHz) |
|------------------------|--------|-------------------|---------------|---------------|
| 00 | BWSEL0 | +2 | 240 | 480 |
| 01 | BWSEL1 | +2 | 180 | 340 |
| 10 | BWSEL2 | -3 | 600 | 1400 |
| 11 | BWSEL3 | -3 | 500 | 900 |

¹ f_{LO} = 2100 MHz, high-side LO injection.

The LO frequency was set to 1800 MHz, 2100 MHz, and 2700 MHz, and the RF frequency was swept. With this measurement approach, Figure 39 to Figure 42 show the effects of both the RF and IF roll-off. The RF roll-off is determined by the integrated RF balun, and the IF roll-off is set by the bandwidth select mode. The effect of both the RF roll-off and IF roll-off is most evident in the widest bandwidth mode (BWSEL2), as shown in Figure 41. Figure 41 shows the flattest and widest bandwidth when the LO frequency is at 2700 MHz because the RF frequency is farthest from the roll-off of the integrated RF balun. In the f_{LO} = 1800 MHz and f_{LO} = 2100 MHz sweeps, the effect of the RF balun becomes evident resulting in a narrower 1 dB bandwidth.

It is very difficult to accurately measure the voltage gain flatness of the ADRF6820 because the signal generators and spectrum analyzers introduce their own amplitude inaccuracies. Additionally, at higher frequencies, the board traces are not as well matched, resulting in signal reflections. With the amplitude errors/inaccuracies from the signal generators and spectrum analyzers included in the measurement, the gain flatness of the ADRF6820 is approximately 0.3 dB for any 100 MHz bandwidth or approximately 0.2 dB for any 20 MHz bandwidth. By design, the gain flatness of the ADRF6820 is substantially better than this; however, the measurement approach is the limiting factor, and the result is quoted as such.

Figure 39 to Figure 42 show data for both positive and negative IF frequencies; positive IF frequencies represent low-side LO injection, and negative frequencies represent high-side LO injection.

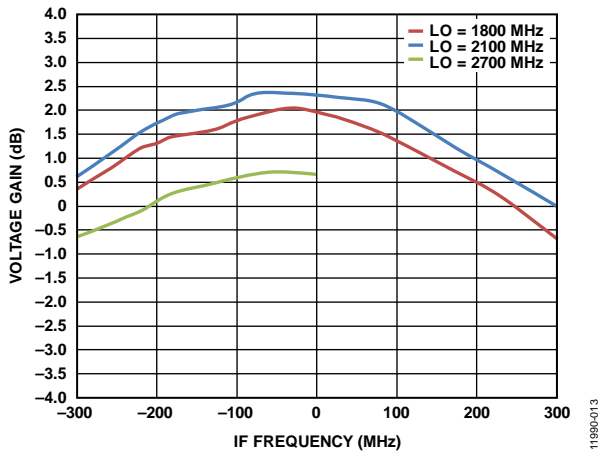

Figure 39. Voltage Gain vs. IF Frequency, BWSEL = 0, LO Fixed and RF Swept

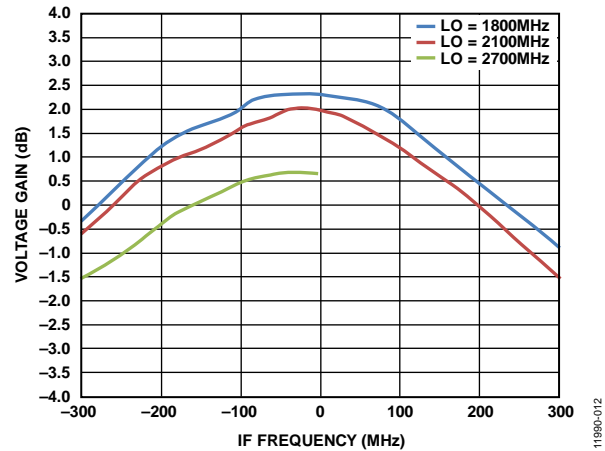

Figure 40. Voltage Gain vs. IF Frequency, BWSEL = 1, LO Fixed and RF Swept

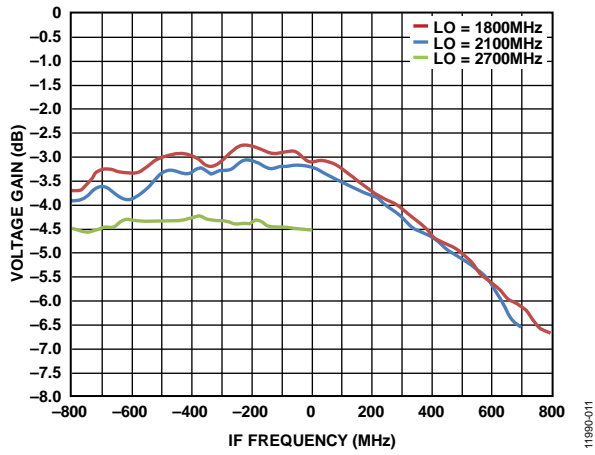

Figure 41. Voltage Gain vs. IF Frequency, BWSEL = 2, LO Fixed and RF Swept

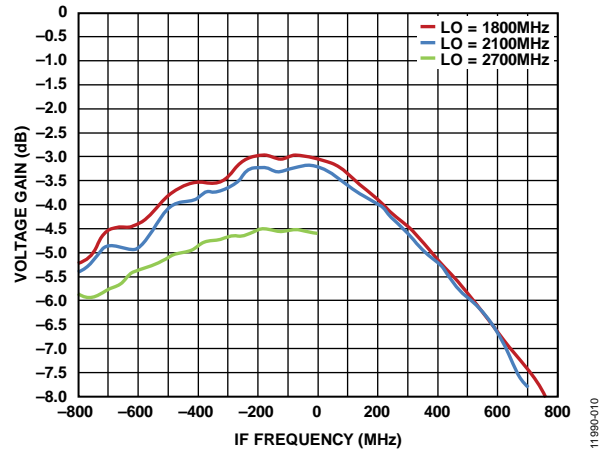

Figure 42. Voltage Gain vs. IF Frequency, BWSEL = 3, LO Fixed and RF Swept

IP3 AND NOISE FIGURE OPTIMIZATION

The ADRF6820 can be configured for either improved performance or reduced power consumption. In applications where performance is critical, the ADRF6820 offers IP3 or noise figure optimization. However, if power consumption is the priority, the mixer bias current can be reduced to save on overall power at the expense of degraded performance. Depending on the application specific needs, the ADRF6820 offers configurability that balances performance and power consumption.

Adjustments to the mixer bias setting have the most impact on performance and power. For this reason, first adjust the mixer bias. The active mixer core of the ADRF6820 is a linearized transconductor. With increased bias current, the transconductor becomes more linear, resulting in higher IP3. The higher IP3, however, is at the expense of degraded noise figure and increased power consumption. For a 1-bit change of the mixer bias (MIX_BIAS, Register 0x31, Bits[12:10]), the total mixer current increases by 8 mA.

Inevitably, there is a limit on how much the bias current can increase before the improvement in linearity no longer justifies the increase in power and noise. The mixer core reaches a point where further increases in bias current do not translate to improved linearity performance. When that point is reached, decrease the bias current to a level where the desired performance is achieved. Depending on the system specifications of the customer, a balance between linearity, noise figure, and power can be attained.

In addition to bias optimization, the ADRF6820 also has configurable distortion cancellation circuitry. The linearized transconductor input of the ADRF6820 is composed of a main path and a secondary path. Through adjustments of the amplitude and phase of the secondary path, the distortion generated by the main path can be canceled, resulting in improved IP3 performance. The amplitude and phase adjustments are located in the following serial interface bits: DEMOD_RDAC (Register 0x31, Bits[8:5]) and DEMOD_CDAC (Register 0x31, Bits[3:0]).

Figure 43 to Figure 46 show the input IP3 and noise figure sweeps for all DEMOD_RDAC, DEMOD_CDAC, and MIX_BIAS combinations. The input IP3 vs. DEMOD_RDAC and DEMOD_CDAC figures show both a surface and a contour plot in one figure. The contour plot is located directly underneath the surface plot. The best approach for reading the figures is to locate the peaks on the surface plot, which indicate maximum input IP3, and to follow the same color pattern to the contour plot to determine the optimized DEMOD_RDAC and DEMOD_CDAC values. The overall shape of the input IP3 plot does not vary with the MIX_BIAS setting; therefore, only MIX_BIAS = 011 is displayed. Table 16 shows the recommended MIX_BIAS, DEMOD_RDAC, and DEMOD_CDAC settings for various RF frequencies. Use Table 16 and Figure 43 to Figure 46 as guides only; do not interpret them in the absolute sense because every application and input signal vary.

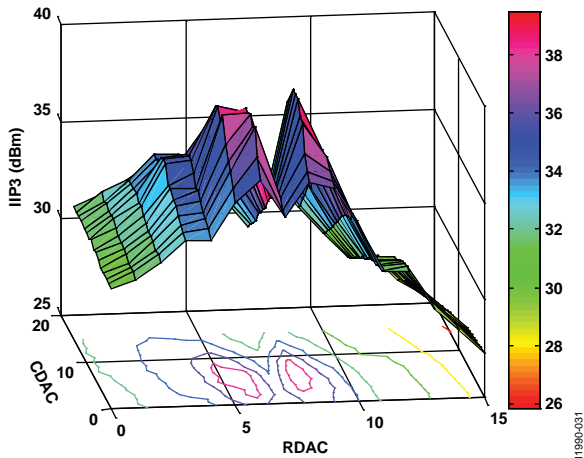

Figure 43. IIP3 vs. DEMOD_CDAC and DEMOD_RDAC, MIX_BIAS = 3 at $f_{RF} = 900$ MHz

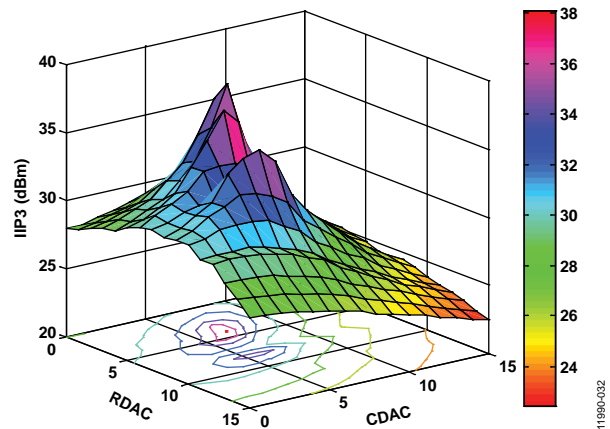

Figure 44. IIP3 vs. DEMOD_CDAC and DEMOD_RDAC, MIX_BIAS = 2 at $f_{RF} = 1900$ MHz

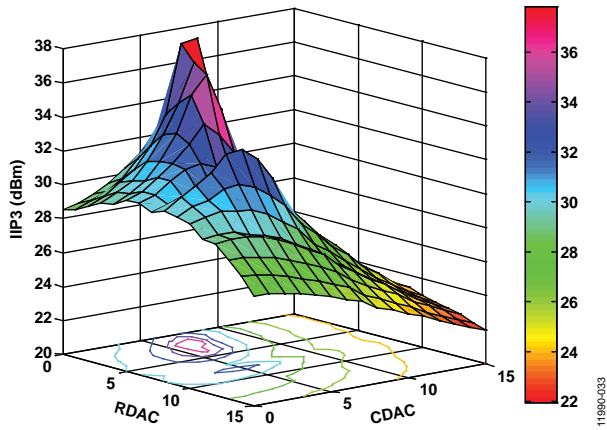

Figure 45. IIP3 vs. DEMOD_CDAC and DEMOD_RDAC, MIX_BIAS = 2 at $f_{RF} = 2100$ MHz

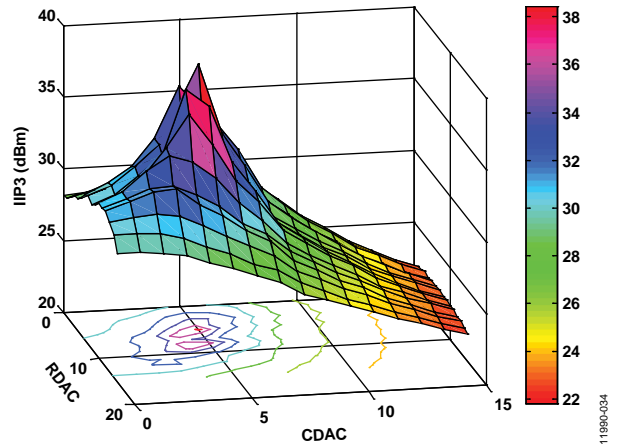

Figure 46. IIP3 vs. DEMOD_CDAC and DEMOD_RDAC, MIX_BIAS = 2 at $f_{RF} = 2700$ MHz

Recommended Settings for BAL_CIN, BAL_COUT, MIX_BIAS, DEMOD_RDAC, and DEMOD_CDAC Settings

Table 16. Recommended Settings

| BWSEL | f _{RF} (MHz) | BAL_CIN | BAL_COUT | MIX_BIAS | DEMOD_RDAC | DEMOD_CDAC |
|-------|-----------------------|---------|----------|----------|------------|------------|
| 0 | 500 | 7 | 7 | 2 | 9 | 10 |
| 0 | 600 | 7 | 7 | 2 | 9 | 10 |
| 0 | 700 | 7 | 7 | 2 | 8 | 11 |
| 0 | 800 | 7 | 3 | 2 | 9 | 4 |
| 0 | 900 | 6 | 2 | 1 | 8 | 7 |
| 0 | 1000 | 5 | 1 | 1 | 8 | 9 |
| 0 | 1100 | 3 | 2 | 1 | 9 | 6 |
| 0 | 1200 | 3 | 1 | 1 | 8 | 8 |
| 0 | 1300 | 2 | 1 | 2 | 8 | 7 |
| 0 | 1400 | 2 | 1 | 2 | 9 | 3 |
| 0 | 1500 | 1 | 1 | 2 | 9 | 4 |
| 0 | 1600 | 1 | 1 | 1 | 8 | 5 |
| 0 | 1700 | 1 | 0 | 1 | 8 | 5 |
| 0 | 1800 | 1 | 1 | 1 | 8 | 6 |
| 0 | 1900 | 1 | 0 | 1 | 8 | 5 |
| 0 | 2000 | 1 | 0 | 2 | 8 | 4 |
| 0 | 2100 | 1 | 0 | 2 | 8 | 4 |
| 0 | 2200 | 1 | 0 | 2 | 9 | 2 |
| 0 | 2300 | 1 | 0 | 2 | 9 | 3 |
| 0 | 2400 | 1 | 0 | 2 | 7 | 3 |
| 0 | 2500 | 1 | 0 | 2 | 7 | 3 |
| 0 | 2600 | 1 | 0 | 2 | 7 | 3 |
| 0 | 2700 | 1 | 0 | 1 | 8 | 4 |
| 0 | 2800 | 1 | 0 | 1 | 8 | 4 |

| BWSEL | f _{RF} (MHz) | BAL_CIN | BAL_COUT | MIX_BIAS | DEMOD_RDAC | DEMOD_CDAC |
|-------|-----------------------|---------|----------|----------|------------|------------|
| 2 | 500 | 7 | 7 | 3 | 5 | 7 |
| 2 | 600 | 7 | 7 | 3 | 5 | 7 |
| 2 | 700 | 7 | 7 | 2 | 4 | 9 |
| 2 | 800 | 7 | 3 | 3 | 8 | 4 |
| 2 | 900 | 6 | 2 | 3 | 9 | 5 |
| 2 | 1000 | 5 | 1 | 3 | 7 | 7 |
| 2 | 1100 | 3 | 2 | 2 | 6 | 9 |
| 2 | 1200 | 3 | 1 | 2 | 8 | 9 |
| 2 | 1300 | 2 | 1 | 2 | 3 | 9 |
| 2 | 1400 | 2 | 1 | 3 | 8 | 5 |
| 2 | 1500 | 1 | 1 | 3 | 8 | 6 |
| 2 | 1600 | 1 | 1 | 2 | 8 | 5 |
| 2 | 1700 | 1 | 0 | 2 | 8 | 5 |
| 2 | 1800 | 1 | 1 | 2 | 8 | 7 |
| 2 | 1900 | 1 | 0 | 2 | 5 | 6 |
| 2 | 2000 | 1 | 0 | 3 | 5 | 7 |
| 2 | 2100 | 1 | 0 | 2 | 4 | 6 |
| 2 | 2200 | 1 | 0 | 2 | 4 | 6 |
| 2 | 2300 | 1 | 0 | 3 | 8 | 6 |
| 2 | 2400 | 1 | 0 | 3 | 8 | 6 |
| 2 | 2500 | 1 | 0 | 3 | 9 | 6 |
| 2 | 2600 | 1 | 0 | 3 | 9 | 6 |
| 2 | 2700 | 1 | 0 | 2 | 8 | 5 |
| 2 | 2800 | 1 | 0 | 2 | 8 | 5 |

I/Q OUTPUT LOADING

The I and Q baseband outputs of the [ADRF6820](#) have a 50 Ω differential impedance. However, voltage gain and linearity performance are optimized with the use of a 200 Ω differential load. This may not be the most favorable termination for every application; therefore, performance trade-offs can be made for lower output loads.

The output load on the differential I/Q outputs has a direct impact on the voltage gain where the gain decreases with lighter loads. The 50 Ω differential source impedance (R_S) of the [ADRF6820](#) forms a voltage divider with the external load resistor (R_L). The performance of the [ADRF6820](#) was optimized for and specified with a differential load termination of 200 Ω. For a 200 Ω differential load termination, the voltage divider ratio is given by

$$V_{OUT}/V_{IN} = R_L/(R_L + R_S)$$

where $R_S = 50 \Omega$.

The change in gain due to different load impedance is given by

$$\frac{Gain(R_{L2})}{Gain(R_{L1})} = \frac{\frac{R_{L2}}{(R_{L2} + R_S)}}{\frac{R_{L1}}{(R_{L1} + R_S)}}$$

where:

$R_{L1} = 200 \Omega$.

R_{L2} is the new load impedance.

The conversion gain of the [ADRF6820](#) at $f_{RF} = 2100 \text{ MHz}$ and $f_{IF} = 200 \text{ MHz}$ is -3.2 dB . For the same test conditions with a 100 Ω load, the gain decreases by $20\log(5/6) = -1.58 \text{ dB}$ to a voltage gain of -4.6 dB . Figure 47 shows the voltage gain vs. IF frequency for $f_{LO} = 1840 \text{ MHz}$ and $BWSEL = 2$ for common output loads.

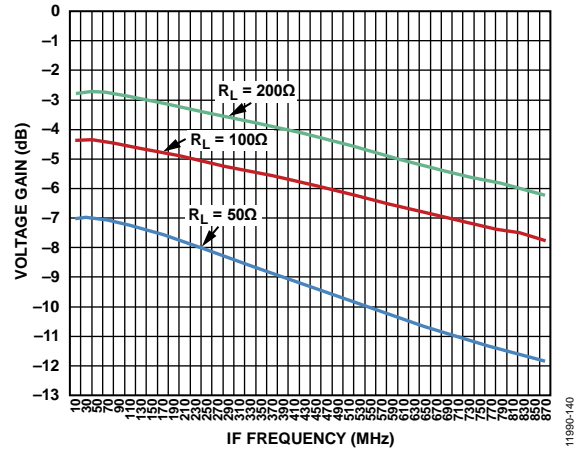

Figure 47. Voltage Gain vs. IF Frequency for $f_{LO} = 1840 \text{ MHz}$, $BWSEL = 2$

In addition to the lower conversion gain, the effect of lower output load impedance is degraded linearity performance. The degraded performance is a result of the emitter follower buffers, after the mixers, needing to deliver more load current; therefore, they operate closer to their nonlinear region. To improve performance with lighter loads, such as 50 Ω, increase the bias current of the emitter follower by increasing `BB_BIAS` (Register 0x34, Bits[11:10]) to its maximum of 13.5 mA. Refer to Table 13 for the bias current settings.

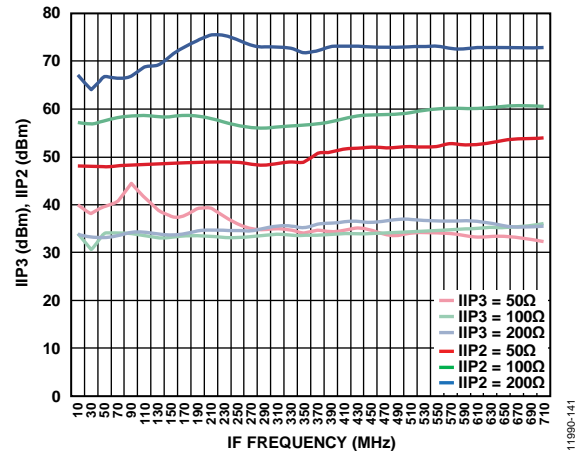

Figure 48. IIP3 and IIP2 vs. IF Frequency for $f_{LO} = 1840 \text{ MHz}$ and $BWSEL = 2$

Figure 48 shows input IP3 and input IP2 performance vs. IF frequency for 50 Ω, 100 Ω, and 200 Ω loads. For the 100 Ω and 200 Ω load impedance, the bias current was configured to its default of 9 mA, whereas for the 50 Ω load, the current was increased to the maximum to achieve the same level of input IP3 performance as the higher output loads.

IMAGE REJECTION

The amplitude and phase mismatch of the baseband I and Q paths directly translates to degradations in image rejection, and for direct conversion systems, maximizing image rejection is key to achieving performance and optimizing bandwidth. The ADRF6820 offers phase adjustment of the I and Q paths independently to allow for quadrature correction. The quadrature correction can be accessed by writing to Register 0x32, Bits[3:0] for the I path correction and Register 0x32, Bits[7:4] for the Q path correction. Figure 49 shows the available correction range for various LO frequencies.

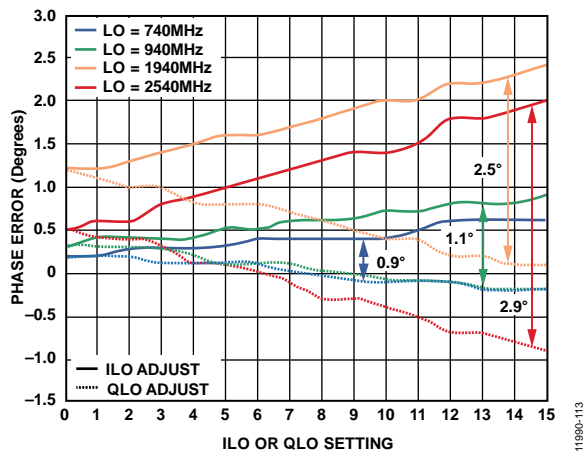

Figure 49. Quadrature Correction Range

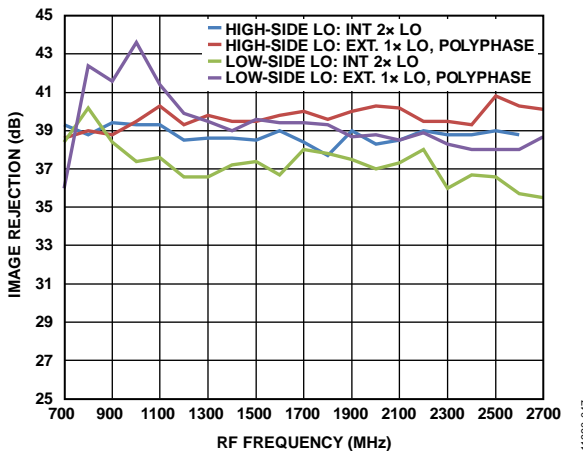

Figure 50. Image Rejection vs. RF Frequency, $f_{IF} = 200$ MHz

Use the following equation to translate the gain and quadrature phase mismatch to image rejection ratio (IRR) performance.

$$IRR (dB) = 10 \log \frac{1 + A_e^2 + 2A_e \cos(\varphi_e)}{1 + A_e^2 - 2A_e \cos(\varphi_e)}$$

where:

A_e is the amplitude error.

φ_e is the phase error.

One of the dominant sources of phase error in a system originates from the demodulator where the quadrature phase split of the LO signal occurs. Figure 50 to Figure 52 show the level of image rejection achievable from the ADRF6820 across different sweep parameters with no correction applied.

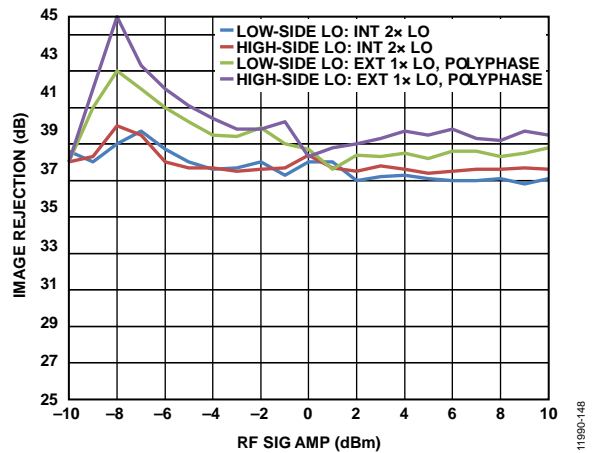

Figure 51. Image Rejection vs. RF Signal Level, $f_{IF} = 200$ MHz, for High-Side LO Injection $f_{LO} = 2000$ MHz and $f_{RF} = 1800$ MHz and Vice Versa for Low-Side Injection

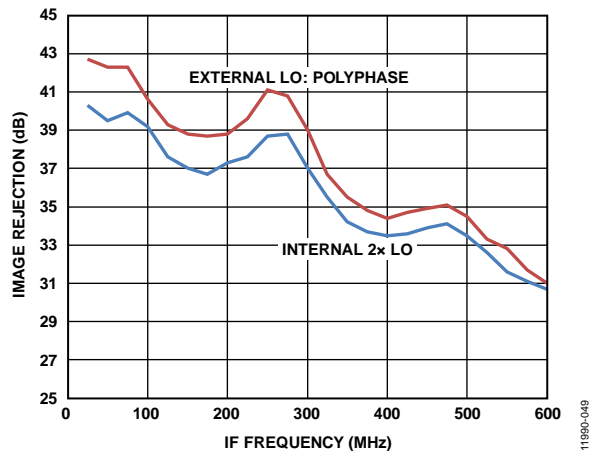

Figure 52. Image Rejection vs. IF Frequency, $f_{LO} = 1800$ MHz

I/Q POLARITY

The ADRF6820 offers the flexibility of specifying the polarity of the I/Q outputs, where I can lead Q or vice versa. By addressing POLI (Register 0x32, Bits[9:8]) or POLQ (Register 0x32, Bits[11:10]), both the I and Q outputs can be inverted from their default configuration. The flexibility of specifying the polarity becomes important when the I and Q outputs are processed simultaneously in the complex domain, $I + jQ$.

At power up, depending on whether high-side or low-side injection of the LO frequency is applied, the I channel can either lead or lag the Q channel by 90° . When the RF frequency is greater than the LO frequency (low-side LO injection), the I channel leads the Q channel (see Figure 53). On the contrary, if the RF frequency is less than the LO frequency (high-side LO injection), the Q channel leads the I channel by 90° (see Figure 54).

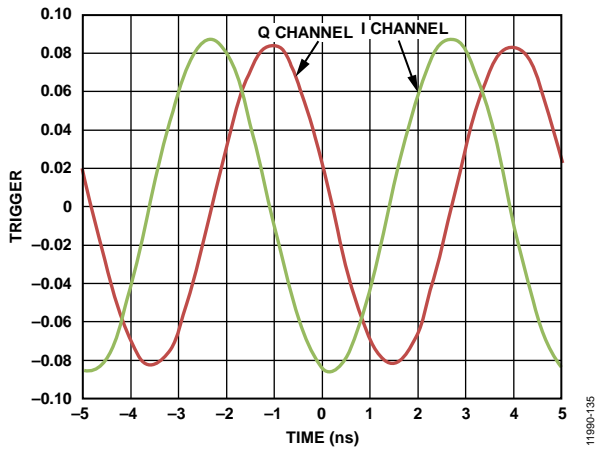

Figure 53. POLI = 1, POLQ = 2, I Channel Normal Polarity, Q Channel Normal Polarity, $f_{RF} = 2040$ MHz, and $f_{LO} = 1840$ MHz

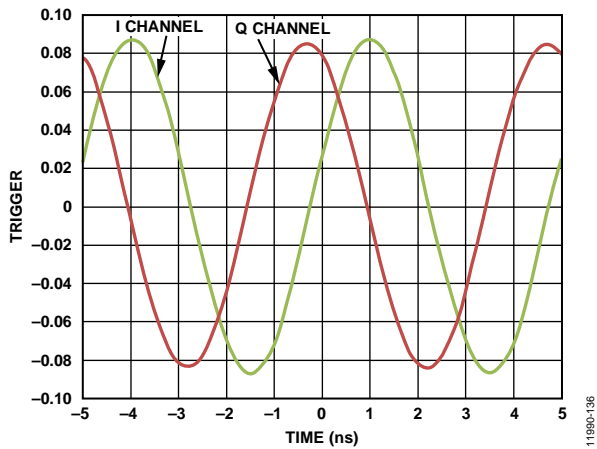

Figure 54. POLI = 1, POLQ = 2, I Channel Normal Polarity, Q Channel Normal Polarity, $f_{RF} = 2040$ MHz, and $f_{LO} = 2240$ MHz

Both the I and Q channels can be inverted to achieve the desired polarity, as shown in Figure 55 to Figure 57, by writing to POLI (Register 0x32, Bits[9:8]) or POLQ (Register 0x32, Bits[11:10]).

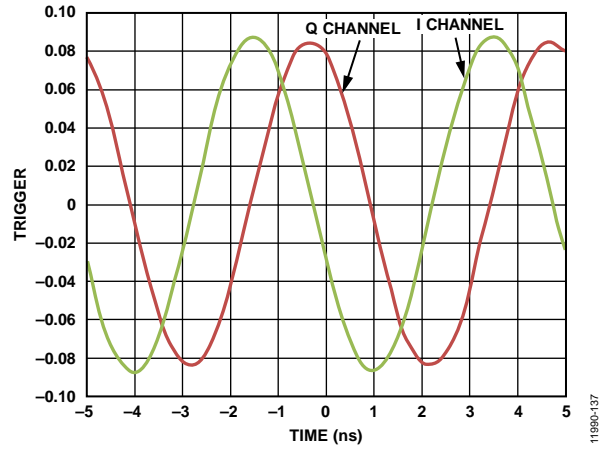

Figure 55. POLI = 2, POLQ = 2, I Channel Invert Polarity, Q Channel Normal Polarity, $f_{RF} = 2040$ MHz, and $f_{LO} = 2240$ MHz

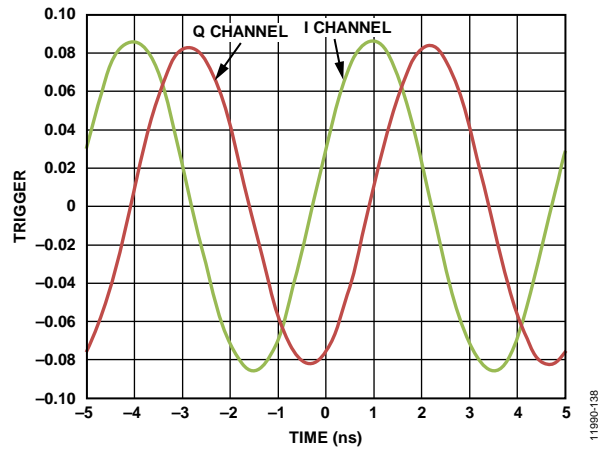

Figure 56. POLI = 1, POLQ = 1, I Channel Normal Polarity, Q Channel Invert Polarity, $f_{RF} = 2040$ MHz, and $f_{LO} = 2240$ MHz

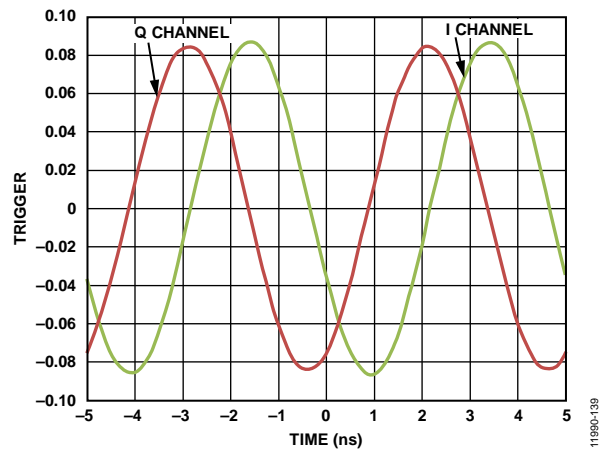

Figure 57. POLI = 2, POLQ = 1, I Channel Invert Polarity, Q Channel Invert Polarity, $f_{RF} = 2040$ MHz, and $f_{LO} = 2240$ MHz

LAYOUT

Careful layout of the [ADRF6820](#) is necessary for performance optimization, and it minimizes stray parasitics. The [ADRF6820](#) supports two RF inputs; therefore, the layout of the RF section is critical in achieving isolation between each channel. Figure 58 shows the recommended layout for the RF inputs. Each RF input, RFIN0 and RFIN1, is isolated between ground pins, and the best layout approach is to keep the traces short and direct. To achieve this, connect the pins directly to the center ground pad of the exposed pad of the [ADRF6820](#). This approach minimizes the trace inductance and promotes better isolation between the channels. In addition, for improved isolation, do not route the RFIN0 and RFIN1 traces in parallel to each other; split the traces immediately after each one leaves the pins. Keep the traces as far away from each other as possible to prevent cross coupling.

The input impedance of the RF inputs is $50\ \Omega$, and the traces leading to the pin must also have a $50\ \Omega$ characteristic impedance. For unused RF inputs, terminate the pins with a dc blocking capacitor to ground.

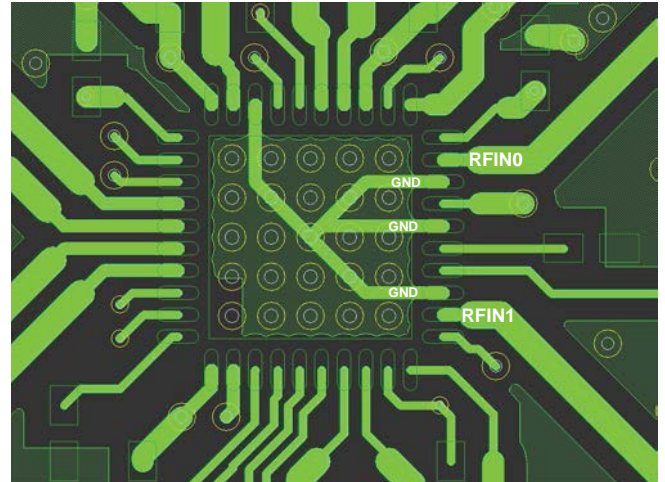

Figure 58. Recommended RF Input Layout

11990-04E

REGISTER MAP

Table 17.

| Hex Addr. | Name | Bits | Bit 15 | Bit 14 | Bit 13 | Bit 12 | Bit 11 | Bit 10 | Bit 9 | Bit 8 | Reset | RW | |
|-----------|-------------|--------|---------------|--------------|--------------|----------|--------------|----------|--------------|------------------|---------------|--------|----|
| | | | Bit 7 | Bit 6 | Bit 5 | Bit 4 | Bit 3 | Bit 2 | Bit 1 | Bit 0 | | | |
| 00 | SOFT_RESET | [15:8] | RESERVED | | | | | | | | | 0x0000 | W |
| | | [7:0] | RESERVED | | | | | | | SOFT_RESET | | | |
| 01 | Enables | [15:8] | RESERVED | | | | | | DMOD_EN | QUAD_DIV_EN | LO_DRV2X_EN | 0xFE7F | RW |
| | | [7:0] | LO_DRV1X_EN | VCO_MUX_EN | REF_BUF_EN | VCO_EN | DIV_EN | CP_EN | VCO_LDO_EN | RESERVED | | | |
| 02 | INT_DIV | [15:8] | RESERVED | | | | DIV_MODE | | INT_DIV | | | 0x002C | RW |
| | | [7:0] | INT_DIV | | | | | | | | | | |
| 03 | FRAC_DIV | [15:8] | FRAC_DIV | | | | | | | | | 0x0128 | RW |
| | | [7:0] | FRAC_DIV | | | | | | | | | | |
| 04 | MOD_DIV | [15:8] | MOD_DIV | | | | | | | | | 0x0600 | RW |
| | | [7:0] | MOD_DIV | | | | | | | | | | |
| 10 | PWRDWN_MASK | [15:8] | RESERVED | | | | | | DMOD_MASK | QUAD_DIV_MASK | LO_DRV2X_MASK | 0xFE7F | RW |
| | | [7:0] | LO_DRV1X_MASK | VCO_MUX_MASK | REF_BUF_MASK | VCO_MASK | DIV_MASK | CP_MASK | VCO_LDO_MASK | RESERVED | | | |
| 20 | CP_CTL | [15:8] | RESERVED | CPSEL | CSCALE | | | | RESERVED | | | 0x0C26 | RW |
| | | [7:0] | RESERVED | | | BLEED | | | | | | | |
| 21 | PFD_CTL | [15:8] | RESERVED | | | | | | | | | 0x0003 | RW |
| | | [7:0] | RESERVED | REF_MUX_SEL | | | PFD_POLARITY | REFSEL | | | | | |
| 22 | VCO_CTL | [15:8] | RESERVED | | | | | | | | | 0x2A03 | RW |
| | | [7:0] | LO_DRV_LVL | DRV2X_EN | DIV8_EN | DIV4_EN | VCO_SEL | | | | | | |
| 23 | DGA_CTL | [15:8] | RESERVED | | | | RFSW_MUX | RESERVED | RFSW_SEL | RFDSA_SEL | 0x0000 | RW | |
| | | [7:0] | RFDSA_SEL | | | RESERVED | | | | | | | |
| 30 | BALUN_CTL | [15:8] | RESERVED | | | | | | | | | 0x0000 | RW |
| | | [7:0] | BAL_COUT | | | RESERVED | BAL_CIN | | | RESERVED | | | |
| 31 | MIXER_CTL | [15:8] | RESERVED | | | | MIX_BIAS | | | RESERVED | DEMOD_RDAC | 0x1101 | RW |
| | | [7:0] | DEMOD_RDAC | | | RESERVED | DEMOD_CDAC | | | | | | |
| 32 | MOD_CTL0 | [15:8] | RESERVED | | | | | POLQ | | POLI | | 0x0900 | RW |
| | | [7:0] | QLO | | | | | ILO | | | | | |
| 33 | MOD_CTL1 | [15:8] | DCOFFI | | | | | | | | | 0x0000 | RW |
| | | [7:0] | DCOFFQ | | | | | | | | | | |
| 34 | MOD_CTL2 | [15:8] | RESERVED | | | | | BB_BIAS | | BWSEL | | 0x0B00 | RW |
| | | [7:0] | RESERVED | | | | | RESERVED | | | | | |
| 40 | PFD_CTL2 | [15:8] | RESERVED | | | | | | | | | 0x0010 | RW |
| | | [7:0] | RESERVED | ABLDLY | | | CPCTRL | | | CLKEDGE | | | |
| 42 | DITH_CTL1 | [15:8] | RESERVED | | | | | | | | | 0x000E | RW |
| | | [7:0] | RESERVED | | | | | DITH_EN | DITH_MAG | DITH_VAL | | | |
| 43 | DITH_CTL2 | [15:8] | DITH_VAL | | | | | | | | | 0x0001 | RW |
| | | [7:0] | DITH_VAL | | | | | | | | | | |
| 44 | DIV_SM_CTL | [15:8] | RESERVED | | | | | | | | | 0x0000 | RW |
| | | [7:0] | RESERVED | | | | | | | BANDCAL_DIVD_CLR | | | |
| 45 | VCO_CTL2 | [15:8] | RESERVED | | | | | | | | | 0x0000 | RW |
| | | [7:0] | VCO_BAND_SRC | BAND | | | | | | | | | |
| 46 | VCO_RB | [15:8] | RESERVED | | | | | | | | | 0x0000 | R |
| | | [7:0] | RESERVED | | | VCO_BAND | | | | | | | |
| 49 | VCO_CTL3 | [15:8] | RESERVED | | | | SET_1 | | | SET_0 | | 0x16BD | RW |
| | | [7:0] | SET_0 | | | | | | | | | | |

REGISTER ADDRESS DESCRIPTIONS

Address: 0x00, Reset: 0x0000, Name: SOFT_RESET

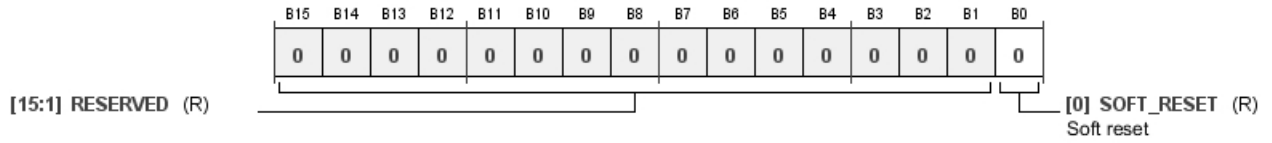

Table 18. Bit Descriptions for SOFT_RESET

| Bits | Bit Name | Settings | Description | Reset | Access |
|------|------------|----------|-------------|--------|--------|
| 0 | SOFT_RESET | | Soft reset | 0x0000 | R |

Address: 0x01, Reset: 0xFE7F, Name: Enables

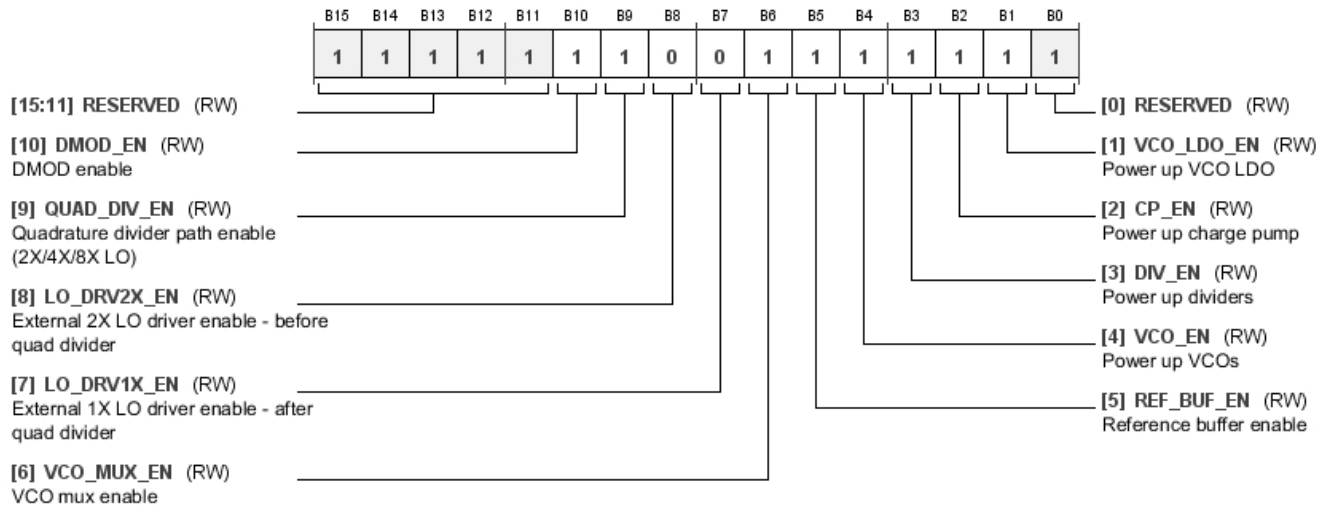

Table 19. Bit Descriptions for Enables

| Bits | Bit Name | Settings | Description | Reset | Access |
|------|-------------|----------|--|-------|--------|
| 10 | DMOD_EN | | DMOD enable | 0x1 | RW |
| 9 | QUAD_DIV_EN | | Quadrature divider path enable (2×/4×/8× LO) | 0x1 | RW |
| 8 | LO_DRV2X_EN | | External 2× LO driver enable—before quad divider | 0x0 | RW |
| 7 | LO_DRV1X_EN | | External 1× LO driver enable—after quad divider | 0x0 | RW |
| 6 | VCO_MUX_EN | | VCO mux enable | 0x1 | RW |
| 5 | REF_BUF_EN | | Reference buffer enable | 0x1 | RW |
| 4 | VCO_EN | | Power up VCOs | 0x1 | RW |
| 3 | DIV_EN | | Power up dividers | 0x1 | RW |
| 2 | CP_EN | | Power up charge pump | 0x1 | RW |
| 1 | VCO_LDO_EN | | Power up VCO LDO | 0x1 | RW |

Address: 0x02, Reset: 0x002C, Name: INT_DIV

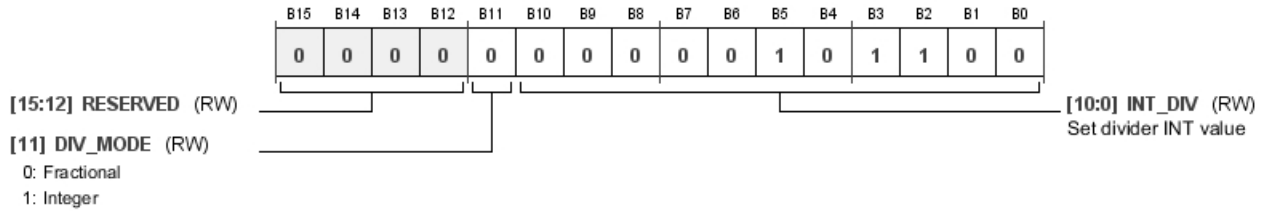

Table 20. Bit Descriptions for INT_DIV

| Bits | Bit Name | Settings | Description | Reset | Access |
|--------|----------|----------|--|-------|--------|
| 11 | DIV_MODE | 0 1 | Divide mode Fractional Integer | 0x0 | RW |
| [10:0] | INT_DIV | | Set divider INT value Integer mode range: 21 to 123 Fractional mode range: 24 to 119 | 0x2C | RW |

Address: 0x03, Reset: 0x0128, Name: FRAC_DIV

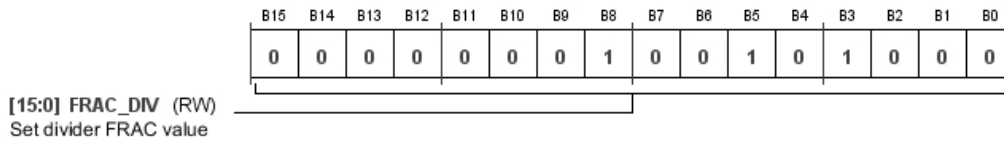

Table 21. Bit Descriptions for FRAC_DIV

| Bits | Bit Name | Settings | Description | Reset | Access |
|--------|----------|----------|------------------------|-------|--------|
| [15:0] | FRAC_DIV | | Set divider FRAC value | 0x128 | RW |

Address: 0x04, Reset: 0x0600, Name: MOD_DIV



Table 22. Bit Descriptions for MOD_DIV

| Bits | Bit Name | Settings | Description | Reset | Access |
|--------|----------|----------|-----------------------|-------|--------|
| [15:0] | MOD_DIV | | Set divider MOD value | 0x600 | RW |

Address: 0x10, Reset: 0xFE7F, Name: PWRDWN_MASK

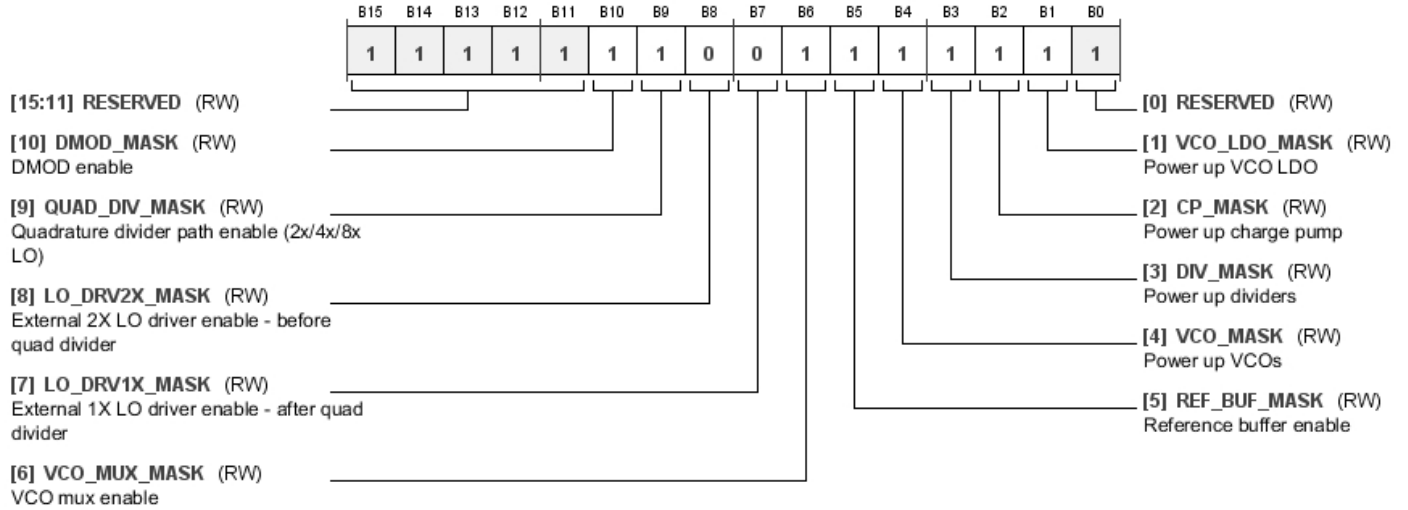

Table 23. Bit Descriptions for PWRDWN_MASK

| Bits | Bit Name | Settings | Description | Reset | Access |
|------|---------------|----------|--|-------|--------|
| 10 | DMOD_MASK | | Demodulator (DMOD) enable | 0x1 | RW |
| 9 | QUAD_DIV_MASK | | Quadrature divider path enable (2x/4x/8x LO) | 0x1 | RW |
| 8 | LO_DRV2X_MASK | | External 2x LO driver enable—before quad divider | 0x0 | RW |
| 7 | LO_DRV1X_MASK | | External 1x LO driver enable—after quad divider | 0x0 | RW |
| 6 | VCO_MUX_MASK | | VCO mux enable | 0x1 | RW |
| 5 | REF_BUF_MASK | | Reference buffer enable | 0x1 | RW |
| 4 | VCO_MASK | | Power up VCOs | 0x1 | RW |
| 3 | DIV_MASK | | Power up dividers | 0x1 | RW |
| 2 | CP_MASK | | Power up charge pump | 0x1 | RW |
| 1 | VCO_LDO_MASK | | Power up VCO LDO | 0x1 | RW |

Address: 0x20, Reset: 0x0C26, Name: CP_CTL

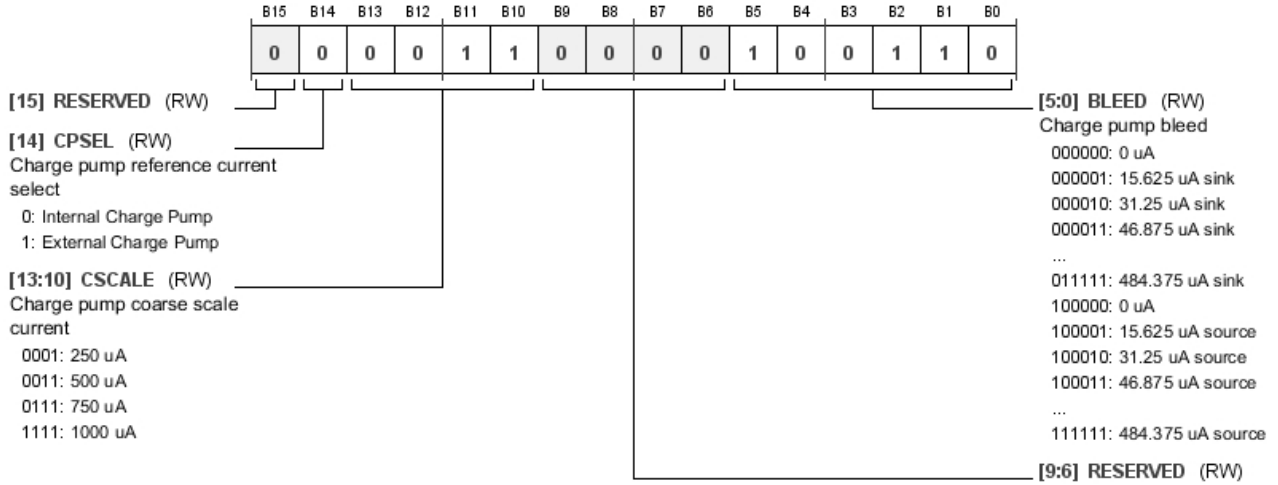

Table 24. Bit Descriptions for CP_CTL

| Bits | Bit Name | Settings | Description | Reset | Access |
|---------|----------|--|---|-------|--------|
| 14 | CPSEL | 0 1 | Charge pump reference current select Internal charge pump External charge pump | 0x0 | RW |
| [13:10] | CSCALE | 0001 0011 0111 1111 | Charge pump coarse scale current 250 μ A 500 μ A 750 μ A 1000 μ A | 0x3 | RW |
| [5:0] | BLEED | 000000 000001 000010 000011 ... 011111 100000 100001 100010 100011 ... 111111 | Charge pump bleed 0 μ A 15.625 μ A sink 31.25 μ A sink 46.875 μ A sink ... 484.375 μ A sink 0 μ A 15.625 μ A source 31.25 μ A source 46.875 μ A source ... 484.375 μ A source | 0x26 | RW |

Address: 0x21, Reset: 0x0003, Name: PFD_CTL

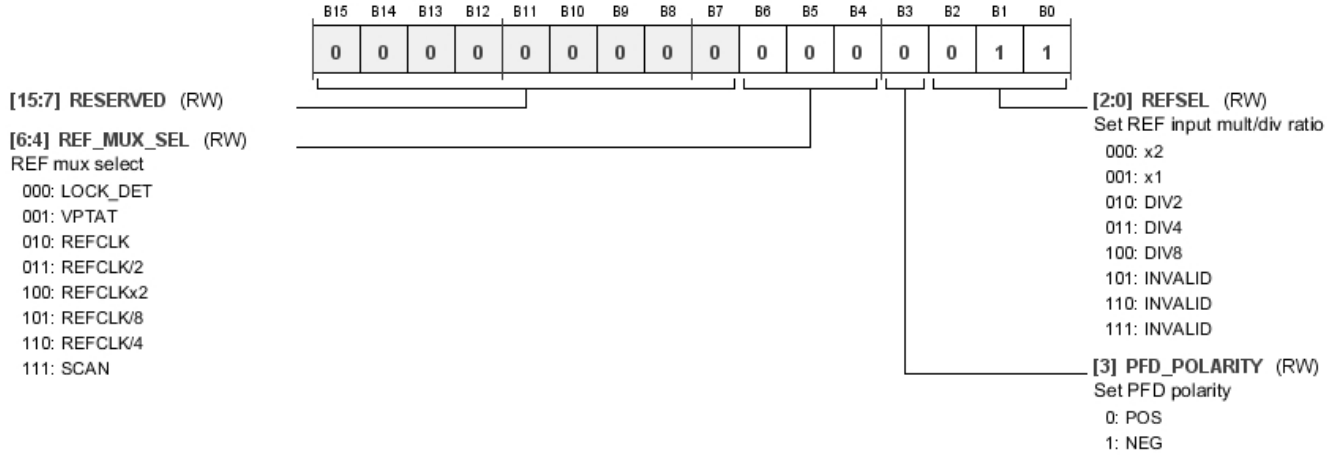

Table 25. Bit Descriptions for PFD_CTL

| Bits | Bit Name | Settings | Description | Reset | Access |
|-------|--------------|--|---|-------|--------|
| [6:4] | REF_MUX_SEL | 000 001 010 011 100 101 110 111 | Reference (REF) mux select LOCK_DET VPTAT REFCLK REFCLK/2 REFCLK × 2 REFCLK/8 REFCLK/4 SCAN | 0x0 | RW |
| 3 | PFD_POLARITY | 0 1 | Set PFD polarity Positive Negative | 0x0 | RW |
| [2:0] | REFSEL | 000 001 010 011 100 | Set REF input multiply/divide ratio ×2 ×1 Divide by 2 Divide by 4 Divide by 8 | 0x3 | RW |

Address: 0x22, Reset: 0x2A03, Name: VCO_CTL

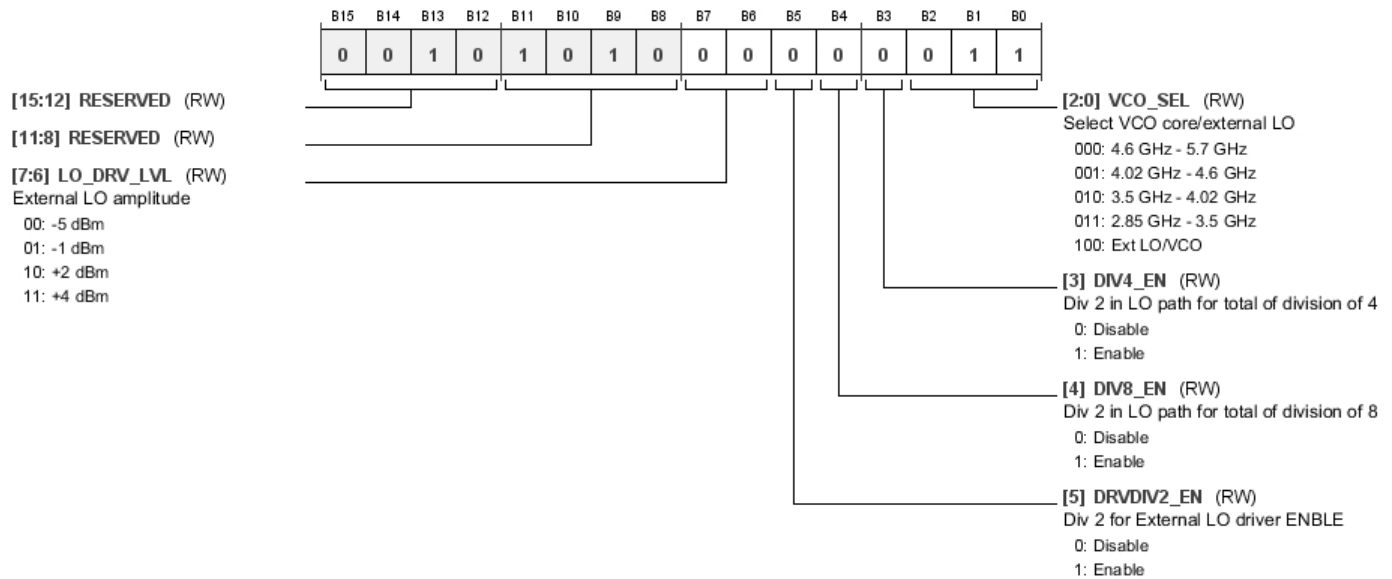

Table 26. Bit Descriptions for VCO_CTL

| Bits | Bit Name | Settings | Description | Reset | Access |
|-------|------------|---------------------------------|---|-------|--------|
| [7:6] | LO_DRV_LVL | 00 01 10 11 | External LO amplitude -5 dBm -1 dBm +2 dBm +4 dBm | 0x0 | RW |
| 5 | DRVDIV2_EN | 0 1 | Divide by 2 for external LO driver enable Disable Enable | 0x0 | RW |
| 4 | DIV8_EN | 0 1 | Divide by 2 in LO path for total of division of 8 Disable Enable | 0x0 | RW |
| 3 | DIV4_EN | 0 1 | Divide by 2 in LO path for total of division of 4 Disable Enable | 0x0 | RW |
| [2:0] | VCO_SEL | 000 001 010 011 100 | Select VCO core/external LO 4.6 GHz to 5.7 GHz 4.02 GHz to 4.6 GHz 3.5 GHz to 4.02 GHz 2.85 GHz to 3.5 GHz External LO/VCO | 0x3 | RW |

Address: 0x23, Reset: 0x0000, Name: DGA_CTL

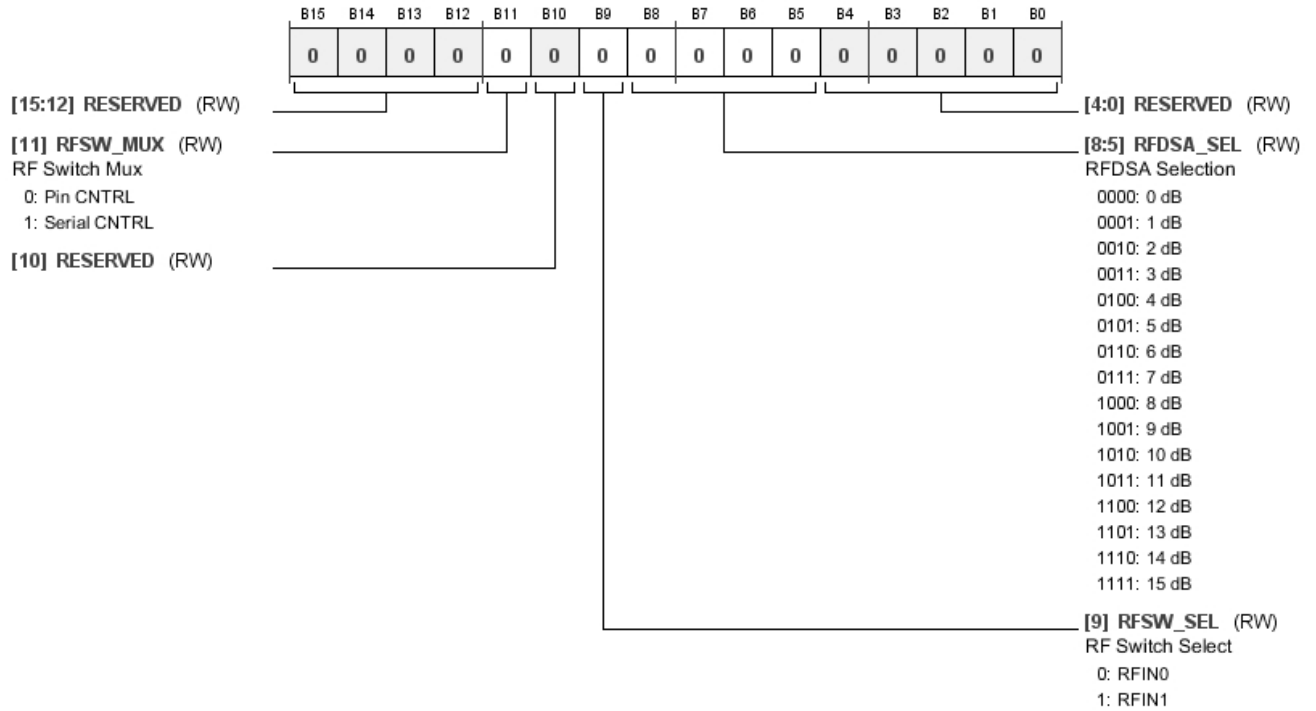

Table 27. Bit Descriptions for DGA_CTL

| Bits | Bit Name | Settings | Description | Reset | Access |
|-------|-----------|--|---|-------|--------|
| 11 | RFSW_MUX | 0 1 | RF switch mux Pin control (CNTRL) Serial control (CNTRL) | 0x0 | RW |
| 9 | RFSW_SEL | 0 1 | RF switch select RFIN0 RFIN1 | 0x0 | RW |
| [8:5] | RFDSA_SEL | 0000 0001 0010 0011 0100 0101 0110 0111 1000 1001 1010 1011 1100 1101 1110 1111 | RFDSA selection 0 dB 1 dB 2 dB 3 dB 4 dB 5 dB 6 dB 7 dB 8 dB 9 dB 10 dB 11 dB 12 dB 13 dB 14 dB 15 dB | 0x0 | RW |

Address: 0x30, Reset: 0x0000, Name: BALUN_CTL

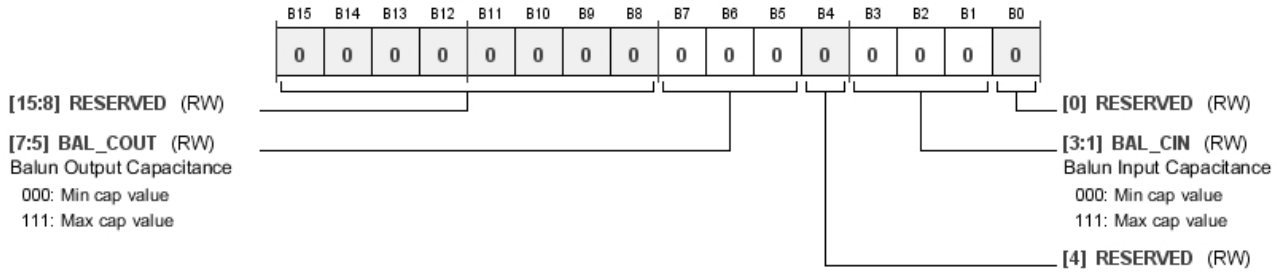

Table 28. Bit Descriptions for BALUN_CTL

| Bits | Bit Name | Settings | Description | Reset | Access |
|-------|----------|------------|--|-------|--------|
| [7:5] | BAL_COUT | 000 111 | Balun output capacitance Minimum capacitance value Maximum capacitance value | 0x0 | RW |
| [3:1] | BAL_CIN | 000 111 | Balun input capacitance Minimum capacitance value Maximum capacitance value | 0x0 | RW |

Address: 0x31, Reset: 0x1101, Name: MIXER_CTL

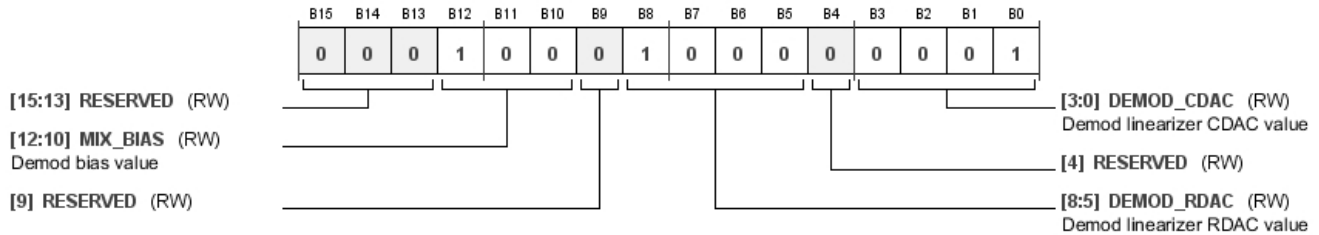

Table 29. Bit Descriptions for MIXER_CTL

| Bits | Bit Name | Settings | Description | Reset | Access |
|---------|------------|----------|-----------------------------------|-------|--------|
| [12:10] | MIX_BIAS | | Demodulator (demod) bias value | 0x4 | RW |
| [8:5] | DEMOD_RDAC | | Demodulator linearizer RDAC value | 0x8 | RW |
| [3:0] | DEMOD_CDAC | | Demodulator linearizer CDAC value | 0x1 | RW |

Address: 0x32, Reset: 0x0900, Name: MOD_CTL0

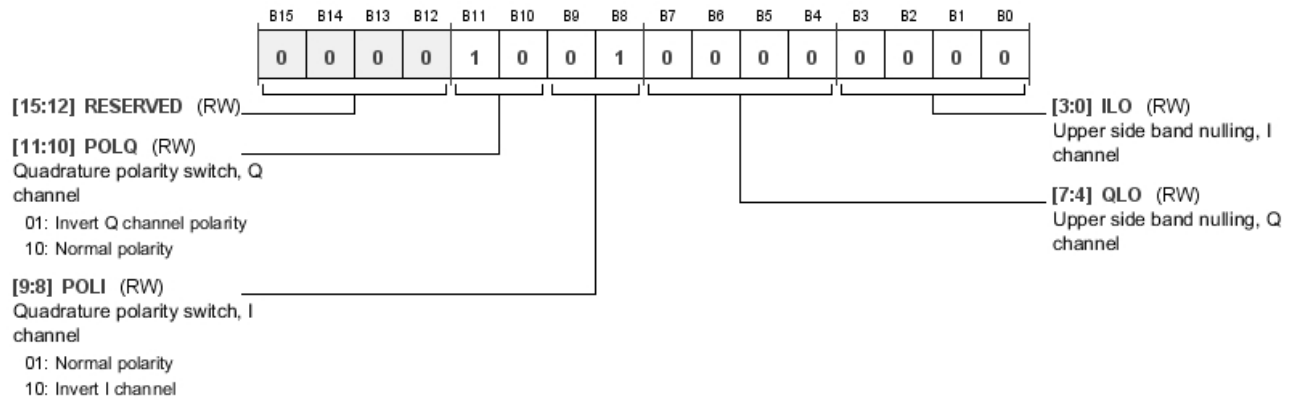
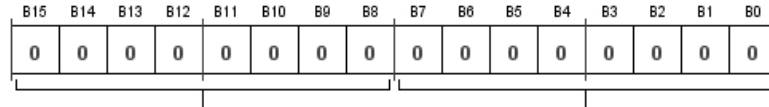

Table 30. Bit Descriptions for MOD_CTL0

| Bits | Bit Name | Settings | Description | Reset | Access |
|---------|----------|----------|---|-------|--------|
| [11:10] | POLQ | 01 10 | Quadrature polarity switch, Q channel Invert Q channel polarity Normal polarity | 0x2 | RW |
| [9:8] | POLI | 01 10 | Quadrature polarity switch, I channel Normal polarity Invert I channel | 0x1 | RW |
| [7:4] | QLO | | Upper side band nulling, Q channel | 0x0 | RW |
| [3:0] | ILO | | Upper side band nulling, I channel | 0x0 | RW |

Address: 0x33, Reset: 0x0000, Name: MOD_CTL1



[15:8] DCOFFI (RW)
 Baseband DC nulling, I channel

- 00000000: 0 μ A
- 00000001: +5 μ A
- 00000010: +10 μ A
- 00000011: +15 μ A
- 01111110: +94.5 μ A
- 01111111: +95.25 μ A
- 10000000: 0 μ A
- 10000001: -5 μ A
- 10000010: -10 μ A
- 10000011: -15 μ A
- 11111110: -94.5 μ A
- 11111111: -95.25 μ A

[7:0] DCOFFQ (RW)
 Baseband DC nulling, Q channel

- 00000000: 0 μ A
- 00000001: +5 μ A
- 00000010: +10 μ A
- 00000011: +15 μ A
- 01111110: +94.5 μ A
- 01111111: +95.25 μ A
- 10000000: 0 μ A
- 10000001: -5 μ A
- 10000010: -10 μ A
- 10000011: -15 μ A
- 11111110: -94.5 μ A
- 11111111: -95.25 μ A

Table 31. Bit Descriptions for MOD_CTL1

| Bits | Bit Name | Settings | Description | Reset | Access |
|--------|----------|--|--|-------|--------|
| [15:8] | DCOFFI | 00000000 00000001 00000010 00000011 01111110 01111111 10000000 10000001 10000010 10000011 11111110 11111111 | Baseband DC nulling, I channel 0 μ A +5 μ A +10 μ A +15 μ A +94.5 μ A +95.25 μ A 0 μ A -5 μ A -10 μ A -15 μ A -94.5 μ A -95.25 μ A | 0x00 | RW |
| [7:0] | DCOFFQ | 00000000 00000001 00000010 00000011 01111110 01111111 10000000 10000001 10000010 10000011 11111110 11111111 | Baseband DC nulling, Q channel 0 μ A +5 μ A +10 μ A +15 μ A +94.5 μ A +95.25 μ A 0 μ A -5 μ A -10 μ A -15 μ A -94.5 μ A -95.25 μ A | 0x00 | RW |

Address: 0x34, Reset: 0x0B00, Name: MOD_CTL2

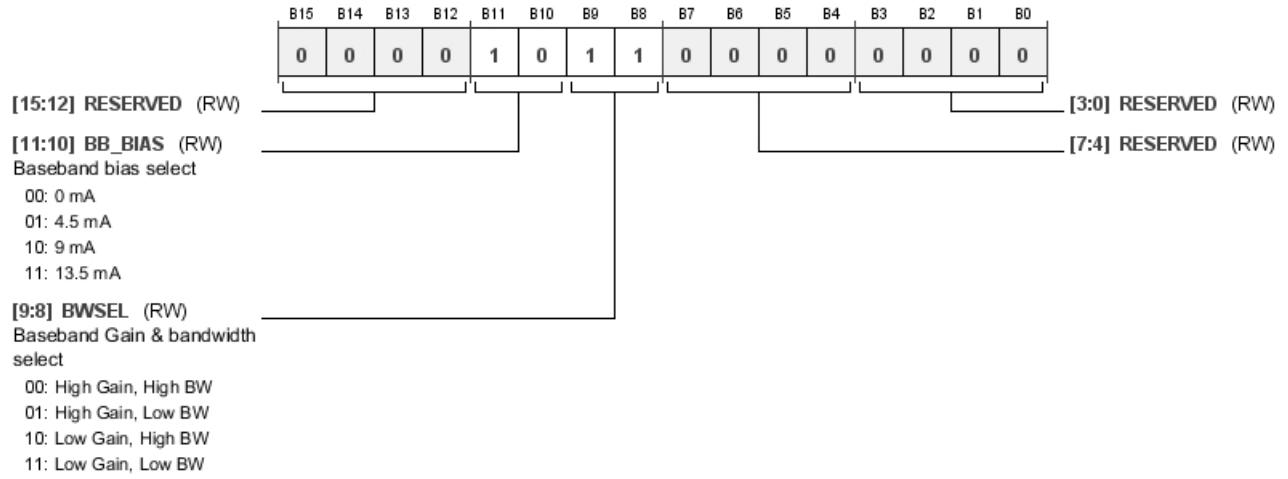

Table 32. Bit Descriptions for MOD_CTL2

| Bits | Bit Name | Settings | Description | Reset | Access |
|---------|----------|----------------------|--|-------|--------|
| [11:10] | BB_BIAS | 00 01 10 11 | Baseband bias select 0 mA 4.5 mA 9 mA 13.5 mA | 0x2 | RW |
| [9:8] | BWSEL | 00 01 10 11 | Baseband gain and bandwidth select High gain, high bandwidth (Refer to Table 15) High gain, low bandwidth (Refer to Table 15) Low gain, high bandwidth (Refer to Table 15) Low gain, low bandwidth (Refer to Table 15) | 0x3 | RW |

Address: 0x40, Reset: 0x0010, Name: PFD_CTL2

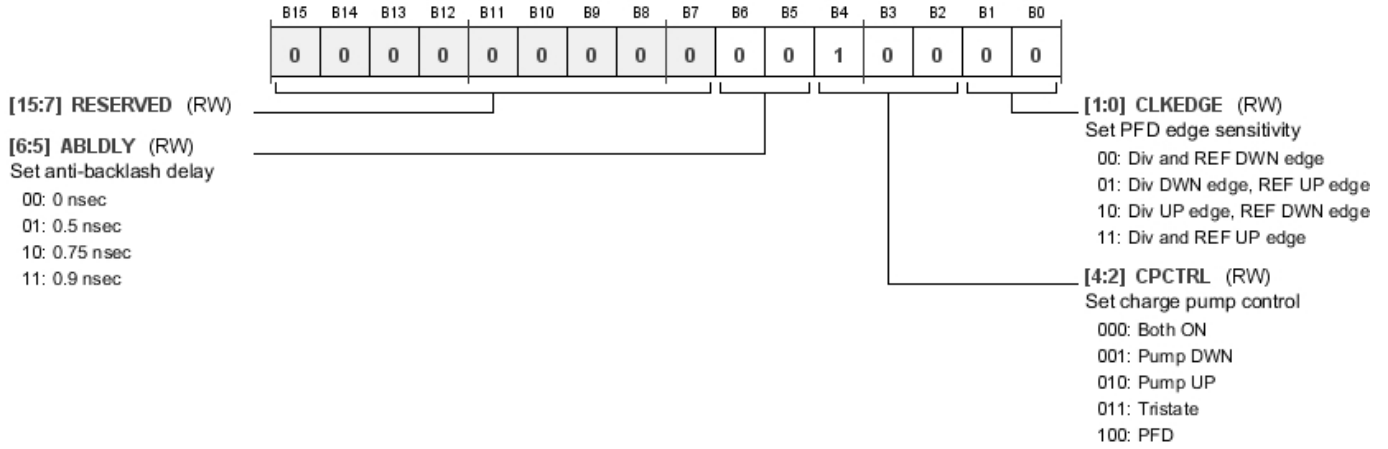

Table 33. Bit Descriptions for PFD_CTL2

| Bits | Bit Name | Settings | Description | Reset | Access |
|-------|----------|---------------------------------|--|-------|--------|
| [6:5] | ABLDLY | 00 01 10 11 | Set antibacklash delay 0 ns 0.5 ns 0.75 ns 0.9 ns | 0x0 | RW |
| [4:2] | CPCTRL | 000 001 010 011 100 | Set charge pump control Both on Pump down Pump up Tristate PFD | 0x4 | RW |
| [1:0] | CLKEDGE | 00 01 10 11 | Set PFD edge sensitivity Div and REF down edge Div down edge, REF up edge Div up edge, REF down edge Div and REF up edge | 0x0 | RW |

Address: 0x42, Reset: 0x000E, Name: DITH_CTL1

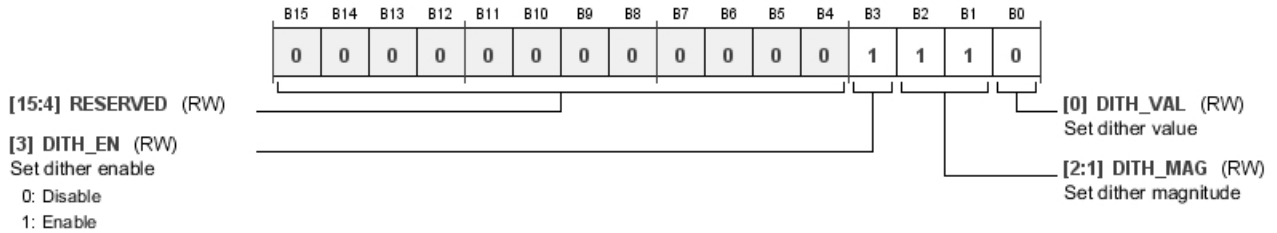

Table 34. Bit Descriptions for DITH_CTL1

| Bits | Bit Name | Settings | Description | Reset | Access |
|-------|----------|----------|--|-------|--------|
| 3 | DITH_EN | 0 1 | Set dither enable Disable Enable | 0x1 | RW |
| [2:1] | DITH_MAG | | Set dither magnitude | 0x3 | RW |
| 0 | DITH_VAL | | Set dither value | 0x0 | RW |

Address: 0x43, Reset: 0x0001, Name: DITH_CTL2

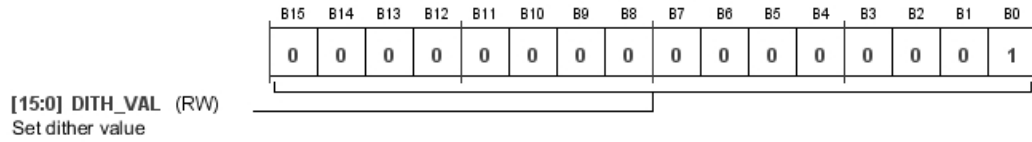

Table 35. Bit Descriptions for DITH_CTL2

| Bits | Bit Name | Settings | Description | Reset | Access |
|--------|----------|----------|------------------|-------|--------|
| [15:0] | DITH_VAL | | Set dither value | 0x1 | RW |

Address: 0x44, Reset: 0x0000, Name: DIV_SM_CTL

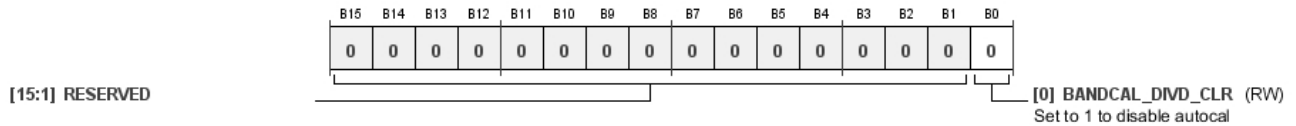

Table 36. Bit Descriptions for DIV_SM_CTL

| Bits | Bit Name | Settings | Description | Reset | Access |
|------|------------------|----------|-----------------------------|-------|--------|
| 0 | BANDCAL_DIVD_CLR | | Set to 1 to disable autocal | 0x0 | RW |

Address: 0x45, Reset: 0x0000, Name: VCO_CTL2

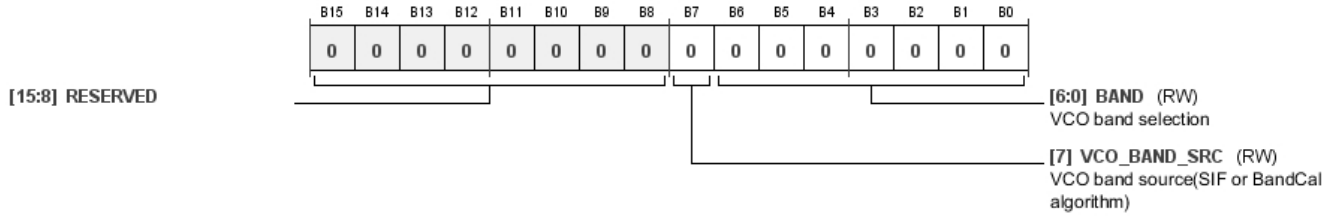

Table 37. Bit Descriptions for VCO_CTL2

| Bits | Bit Name | Settings | Description | Reset | Access |
|-------|--------------|----------|---|-------|--------|
| 7 | VCO_BAND_SRC | | VCO band source(SIF or BANDCAL algorithm) | 0x0 | RW |
| [6:0] | BAND | | VCO band selection | 0x00 | RW |

Address: 0x46, Reset: 0x0000, Name: VCO_RB

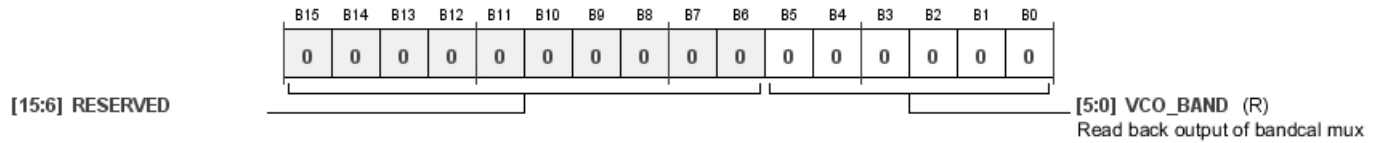

Table 38. Bit Descriptions for VCO_RB

| Bits | Bit Name | Settings | Description | Reset | Access |
|-------|----------|----------|---------------------------------|-------|--------|
| [5:0] | VCO_BAND | | Read back output of BANDCAL mux | 0x00 | R |

Address: 0x49, Reset: 0x16BD, Name: VCO_CTL3

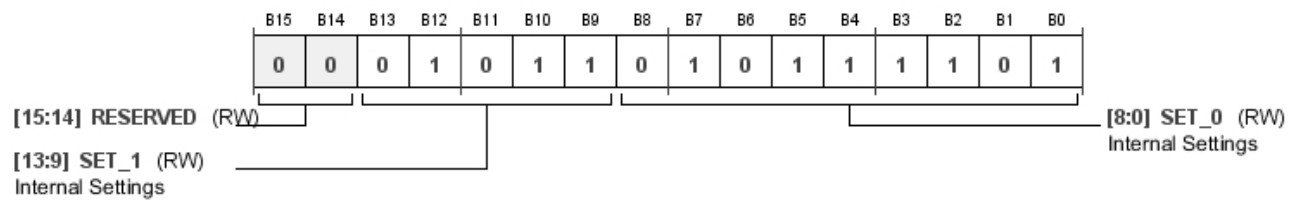
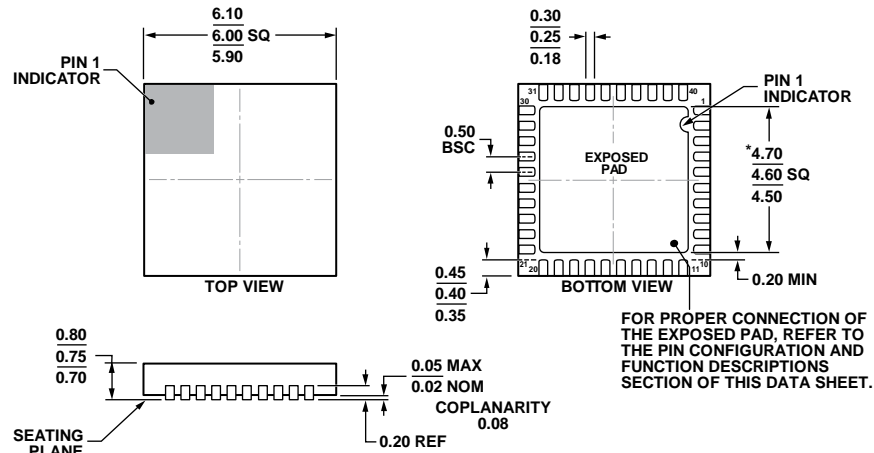

Table 39. Bit Descriptions for VCO_CTL3

| Bits | Bit Name | Settings | Description | Reset | Access |
|--------|----------|----------|--|-------|--------|
| [13:9] | SET_1 | | Internal settings (refer to the Required PLL/VCO Settings and Register Write Sequence section) | 0xB | RW |
| [8:0] | SET_0 | | Internal settings (refer to the Required PLL/VCO Settings and Register Write Sequence section) | 0xBD | RW |

OUTLINE DIMENSIONS



COMPLIANT TO JEDEC STANDARDS MO-220-WJJD-5
WITH EXCEPTION TO EXPOSED PAD DIMENSION.

Figure 59. 40-Lead Lead Frame Chip Scale Package [LFCSP_WQ]
6 mm × 6 mm Body, Very Very Thin Quad
(CP-40-7)
Dimensions shown in millimeters

06-04-2012-A

ORDERING GUIDE

| Model ¹ | Temperature Range | Package Description | Package Option |
|--------------------|-------------------|--|----------------|
| ADRF6820ACPZ-R7 | -40°C to +85°C | 40-Lead Lead Frame Chip Scale Package [LFCSP_WQ] | CP-40-7 |
| ADRF6820-EVALZ | | Evaluation Board | |

¹ Z = RoHS Compliant Part.

NOTES

NOTES

NOTES