



ITT

Interconnect Solutions  
Cannon, VEAM, BIW

Ensuring over **20 years**  
of mission critical communication  
between two worlds across  
**250,000,000 miles**



*Engineered for life*

## D Subminiature Selector Guide

<b>D- Subminiature</b>			
<b>Series</b>	<b>D*NM</b>	<b>D*H</b>	<b>MIL-DTL-24308</b>
<b>Wire Gauge Range AWG</b>	AWG 18 - 30	up to AWG 20	AWG 18 - 30
<b>Mating Cycles</b>	500	500	500
<b>RoHS confirm</b>	Available	No	No
<b>Layout</b>	9, 15, 25, 37, 50, 15, 26, 44, 62, 78, 104 (high density and Combo D)	9, 15, 25, 37, 50	9, 15, 25, 37, 50, 15, 26, 44, 62, 78 (high density )
<b>Operating Voltage</b>	1000 VAC*	750 VAC*	1700 VAC*
<b>Current Rating (Amps)</b>	7,5 A max	7,5 A max	7,5 A max
<b>Contact Resistance</b>	10 milli Ohm max	15 milli Ohm max	10 milli Ohm max
<b>Operating Temperature</b>	-55°C/125°C	-55°C/125°C	-50°C/150°C
<b>Mil Salt Spray Test Resistance in hours</b>	48 hours	48 hours	48 hours
<b>Shell Material</b>	Copper Alloy	Steel	Steel
<b>Shell Finish</b>	Gold over Copper (K52)	Electro-deposited tin over cadmium over copper flash	Yellow Chromate over Cadmium or Zinc
<b>Insulator</b>	Thermoplastic, PCT UL94V-0	Compression Glass	Thermoplastic, PCT UL 94V-0
<b>Contact Type</b>	Turned	Turned	Turned
<b>Contact Material</b>	Copper Alloy	Steel	Copper Alloy
<b>Contact Finish</b>	1,27 µm gold over copper	Electro-deposited tin over cadmium over copper flash	1,27 µm gold
<b>Page Number</b>	C-9	J-45	C-11

<b>D- Subminiature</b>			
<b>Series</b>	<b>D*MAM</b>	<b>D*MM</b>	<b>D*D</b>
<b>Wire Gauge Range AWG</b>	AWG 18 - 30	AWG 18-30	AWG 20 - 24
<b>Mating Cycles</b>	500	500	500
<b>RoHS confirm</b>	No	No	No
<b>Layout</b>	9, 15, 25, 37, 50, 15, 26, 44, 62, 78 (high density)	9, 15, 25, 37, 50	9, 15, 25, 37, 50
<b>Operating Voltage</b>	1700 VAC*	1700 VAC*	1700 VAC
<b>Current Rating (Amps)</b>	7,5 A max	7,5 A max	7,5 A max
<b>Contact Resistance</b>	10 milli Ohm max (Signal Contacts)	10 milli Ohm max	10 milli Ohm max
<b>Operating Temperature</b>	-50°C/150°C	-50°C/150°C	-50°C/150°C
<b>Mil Salt Spray Test Resistance in hours</b>	48 hours	48 hours	48 hours
<b>Shell Material</b>	Steel	Steel	Aluminum
<b>Shell Finish</b>	RoHS - Tin/Nickel Yellow chromate over cadmium or zinc	RoHS - Tin/Nickel Yellow chromate over cadmium or zinc	Yellow chromate over cadmium or zinc
<b>Insulator</b>	Thermoplastic, Type PCT UL 94V-0	Thermoplastic, PCT UL 94V-0	Thermoplastic, PCT UL 94V-0
<b>Contact Type</b>	Turned	Turned	Turned
<b>Contact Material</b>	Copper Alloy	Copper Alloy	Copper Alloy
<b>Contact Finish</b>	1,27 µm gold	1,27 µm gold	1,27 µm gold
<b>Page Number</b>	C-11	C-18	C-40



0880

C

D Sub

## D Subminiature Selector Guide

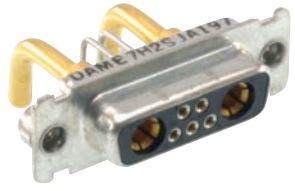
<b>D- Subminiature</b>			
<b>Series</b>	<b>D*M</b>	<b>D*MA</b>	<b>GD*</b>
<b>Wire Gauge Range AWG</b>	AWG 20-28	AWG 18-30	AWG 18-30
<b>Mating Cycles</b>	200,500	200,500	500
<b>RoHS confirm</b>	Available	Available	no
<b>Layout</b>	9, 15, 25, 37, 50	9, 15, 25, 37, 50, 15, 26, 44, 62, 78, 104 (high density)	9, 15, 25, 37, 50, 15, 26, 44, 62, 78, 104 (high density)
<b>Operating Voltage</b>	1000 VAC*	1000 VAC*	1000 VAC*
<b>Current Rating (Amps)</b>	7,5 A max	7,5 A max	7,5 A max
<b>Contact Resistance</b>	10 milli Ohm max	10 milli Ohm max	10 milli Ohm max
<b>Operating Temperature</b>	-55°C/125°C	-55°C/125°C	-65°C/150°C
<b>Mil Salt Spray Test Resistance in hours</b>	20 hours (Mil:48 hours)	48 hours	48 hours
<b>Shell Material</b>	Steel	Steel	Steel
<b>Shell Finish</b>	RoHS - Tin/Nickel Yellow chromate over cadmium or zinc	RoHS - Tin/Nickel Yellow chromate over cadmium or zinc	Yellow chromate over cadmium or zinc
<b>Insulator</b>	Thermoplastic, PCT UL 94V-0	Thermoplastic, PCT UL 94V-0	Thermoplastic, PCT UL 94V-0
<b>Contact Type</b>	Turned	Turned	Turned
<b>Contact Material</b>	Copper Alloy	Copper Alloy	Copper Alloy
<b>Contact Finish</b>	Gold over Nickel	Gold over Nickel	Gold over Nickel
<b>Page Number</b>	C-9	C-11	C-37

<b>D- Subminiature</b>		
<b>Series</b>	<b>Combo D</b>	<b>Stainless Steel-F225</b>
<b>Wire Gauge Range AWG</b>	AWG 8-30	-
<b>Mating Cycles</b>	50,200,500	500
<b>RoHS confirm</b>	yes (MIL:no)	yes
<b>Layout</b>	E: 2W2; 2WK2; 5W1 A: 3W3; 3WK3; 7W2; 11W1 B: 5W5; 9W4; 13W3; 17W2; 21W1 C: 8W8; 13W6; 17W5; 21WA4; 25W3; 27W2 D: 24W7; 36W4; 43W2; 47W1	9,15,25,37,50, 15, 26,44,62,78 (standard high density and Combo D)
<b>Operating Voltage</b>	500 VAC*	-
<b>Current Rating (Amps)</b>	7,5 A max(Signal Contacts) 5 A max (Coaxial Contacts) 40 A max (High Power Contacts) 5 A Max (HV Contacts)	-
<b>Contact Resistance</b>	10 milli Ohm max (Signal Contacts) 40 Millivolt Max @ 40A (Power)	-
<b>Operating Temperature</b>	-55°C/125°C (MIL:150°C)	-55°C/125°C
<b>Mil Salt Spray Test Resistance in hours</b>	20 hours (MIL: 48 hours)	500 hours
<b>Material</b>	Steel	Stainless Steel
<b>Finish</b>	Tin	Passivated
<b>Insulator</b>	Thermoplastic, PCT UL 94V-0	-
<b>Contact</b>	Turned	-
<b>Material</b>	Copper Alloy	-
<b>Finish</b>	Gold over Nickel	-
<b>Page Number</b>	C-21	C-7



D Sub



## Solder Cup, Crimp, and PCB Type, Combo-D's with Machined Contacts

Typical Part Number:

DBM   C   13X3   S   J   101

**Product Family Designator**

- D\*M = Solder Cup & Std. Density PCB Industrial/Commercial Version
- D\*MM = Solder Cup & PCB Mil version (50 micro-inch gold contact/plating)
- D\*A = Crimp signal contacts

**Hardware Modifier\***

- = 0.120" (3,05mm) Through Hole
- B = 4-40 Female Screwlock
- C = 90° Metal Bracket, 4-40 Fastener, & Boardlock (D\*M, D\*MM Only)
- D = 90° Metal Bracket, 4-40 Fastener and 4-40 Screwlock (D\*M, D\*MM Only)
- E = 4-40 Clinchnut
- G = 90° Metal Bracket, 4-40 Fastener, 4-40 Screwlock, Boardlock (D\*M, D\*MM)
- H = .300" (7.6mm) Standoff, 4-40 Screwlock (D\*M, D\*MM US Only)
- I = 90° metal bracket, .120" (3.05mm) through hole
- K = 0.162" (4,11mm) Through Hole
- N = .300" (7.6mm) Standoff, 4-40 Screwlock, Boardlock (D\*M, D\*MM Only)
- P = 90° Metal Bracket, 4-40 Fastener (D\*M, D\*MM)
- S = 90° Metal Bracket, M-3 Fastener (D\*M, D\*MM)
- V = .300" (7.6mm) 4-40 Standoff (D\*M, D\*MM Only)
- X = M3 clinchnut
- Y = Dual Float Mount
- Z = .300" (7.6mm) 4-40 Standoff, Boardlock (D\*M, D\*MM Only)
- \* = Shell Sizes are E, A, B, C, D

\* Note: Combo-D hardware and finishes are available on D\*M standard density 9, 15, 25, 37 and 50 position connectors

**Shell Modifier (Standard)\***

- = Yellow chromate over zinc shells
- A101 = Yellow Chromate over Cadmium shells
- F225 = Stainless steel shells (RoHS) (Non Hardware Versions Only)
- A197 = Pure Tin over Nickel Shells (Sockets only, RoHS through hole versions only)
- K87 = Pure Tin over Nickel Shells w/grounding dimples (Pins only, RoHS)

**PC Tail Modifier (Standard)\***

- = Solder Cup (D\*M/D\*MM; Crimp, D\*MA, D\*MAM)
- J = 90° Std. PCB signal contact (.170" lg by .030" )
- N = Straight Std. PCB signal contact (.178" lg by .030 Ø)
- V = 90° Euro PCB signal contact (.157" lg by .024 Ø)
- Y = Straight Euro PCB signal contact (.178" lg by .024 Ø)

**Gender**

- P = Male Plug, Pin
- S = Female Receptacle, Socket

**Layouts -**

- \*Combo D E-2W2; 2WK2K, 9 (D\*M) A- 5W1; A- 3W3, 3WK3, 7W2, 11W1, 95
- B- 5W5, 9W4, 13W3, 17W2, 21W1, 25
- C- 8W8, 13W6, 17W5, 21WA4, 25W3, 27W2, 37
- D- 24W7, 36W4, 43W2, 47W1, 50

**Combo-D Size 8 Contact Designators:**

- W = w/o Contacts (letters below denote with contacts)
- C = 75 Ohm Coax Contacts Installed, stamped
- X = 50 Ohm Coax Contacts Installed, stamped
- H = High Power Installed
- V = High Voltage Installed (Cable and straight PCB only)
- R = Mini Hi Power 90° Installed
- F = Fiber Optic
- G = Guide Pin
- P = High Power Installed (European)
- M = 50 ohm coax contact installed, machined
- N = 40 ohm coax contact installed, machined



# Military/Hi-Reliability D\*M D-Subminiature Ordering Information - Connector Designator

For Hi-Reliability Crimp, Solder Cup and PCB Type, Standard & Hi-Density Connectors with Machined Contacts

Typical Part Number:

DBM\* E 25 P M NMB A197 FO

**• Product Family Designator**

- D\*M = Solder Cup & Std. Density PCB Industrial/Commercial Version (without spacer for straight PCB)
- D\*MM = Solder Cup & PCB Mil version (50 micro-inch gold contact/plating, with spacer for straight PCB)
- D\*MA = Crimp & Hi-Density PCB Industrial/Commercial Version
- D\*MAM = Crimp/Hi-Density PCB Mil version (50 microinch gold contact plating)

**• Hardware Modifier**

- = 0.120" (3,05mm) Through Hole
- B = 4-40 Female Screwlock
- E = 4-40 Clinchnut
- K = 0.162" (4,11mm) Through Hole
- X = M3 clinchnut
- Y = Dual Float Mount
- \* = Shell Sizes are E, A, B, C, D

**• Layouts**

- \*Standard Density (D\*M, D\*MM) 9, 15, 25, 37, 50
- \*High Density (D\*MA, D\*MAM) 15, 26, 44, 62, 78, 104

**• Gender**

- P = Male Plug, Pin
- S = Female Receptacle, Socket

FO - Without contacts - D\*MA crimp versions only

**• Modifier (standard)**

- Yellow chromate over zinc shells
- A197 Tin over Nickel shells (receptacles only) (RoHS)
- F224 Epoxy sealing of insulator to shell and contacts
- F225 303 Stainless steel, passivated (Non Hardware Versions Only)
- K52 50 gold over copper plating on shells and contacts
- K87 Tin, dimpled shells (plugs only) (RoHS) (US only)
- K128 K52 gold plating on Aluminum Shells, Nickel Under Plate
- F216 Machined Aluminum Shells, Nickel Under Plate
- A101 Yellow chromate over cadmium

**• Residual Magnetism/Outgassing**

NMB- 200 Gamma Max. Residual Magnetism/<1% TML

**• PC Tail Modifier (Standard Density)**

- = Solder cup (D\*M/D\*MM)
- A = 90° PCB contact w/Plastic Bracket (.99" - .154" lg by .040" Ø)
- B = Straight PCB contact (.99" - .154" lg by .040" Ø)
- C = 90° PCB contact w/o Plastic Bracket (.99" - .154" lg by .040" Ø)
- D = 90° PCB contact w/Plastic Bracket (.99" - .154" lg by .030" Ø)
- E = Straight PCB contact (.99" - .154" lg by .030" Ø)
- F = 90° PCB contact w/o Plastic Bracket (.99" - .154" lg by .030" Ø)
- G = 90° PCB contact w/Plastic Bracket (.130" - .185" lg by .040" Ø)
- H = Straight PCB contact (.130" - .185" lg by .040" Ø)
- K = 90° PCB contact w/o Plastic Bracket (.130" - .185" lg by .040" Ø)
- L = 90° PCB contact w/Plastic Bracket (.130" - .185" lg by .030" Ø)
- M = Straight PCB contact (.130" - .185" lg by .040" Ø)
- P = 90° PCB contact w/o Plastic Bracket (.130" - .185" lg by .030" Ø)
- R = 90° PCB contact w/o Plastic Bracket (.155" - .210" lg by .030" Ø)
- S = 90° PCB contact w/Plastic Bracket (.155" - .210" lg by .030" Ø)
- W = 90° PCB contact w/Plastic Bracket (.155" - .210" lg by .040" Ø)
- X = Straight PCB contact (.155" - .210" lg by .030" Ø)
- Z = Straight PCB contact (.155" - .210" lg by .040" Ø)
- F179 = Straight square PCB or wire wrap contact (.375" by .024")
- F179A = Straight square PCB or wire wrap contact (.500" by .024")
- \*\*L = 90° PCB contact w/Plastic Bracket (.140" lg by .021" Ø)
- \*\*M = Straight PCB contact (.140" lg by .021" Ø)
- \*\*P = 90° PCB contact w/o Plastic Bracket (.140" lg by .021" Ø)
- R = 90° PCB contact w/o Plastic Bracket (.197" lg by .021" Ø)
- S = 90° PCB contact w/Plastic Bracket (.197" lg by .021" Ø)
- Z/OL3 = Straight PCB contact (.197" lg by .021" Ø)

\* 104 Position Available in Machined Aluminum Shells only

\* = Crimp (D\*MA, D\*MAM)

\* = Shell Sizes are E, A, B, C, D, F (F available in high density aluminum only)

\*\* = Legacy Tail Modifiers "D", "E" and "F" have been replaced by Tail Modifiers "L", "M" and "P" respectively.

D Sub



Dimensions shown in inches (mm)  
Specifications and dimensions subject to change

www.ittcannon.com



Solder Cup

Plug

- For contact cavity arrangements, see pages C-44.
- For panel cutouts, see page C-49.
- Accepts up to 18 AWG.

Shell Size	Layout	Through Hole	Dual Float Mount
DE	9	DEM9P	DEMY9P
DA	15	DAM15P	DAMY15P
DB	25	DBM25P	DBMY25P
DC	37	DCM37P	DCMY37P
DD	50	DDM50P	DDMY50P

Note: For residual magnetism level of 200 gamma and shells and contacts with 50 microinches (1,27 m) gold plating, add NMBK52"

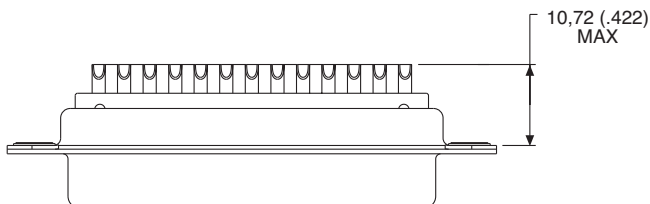
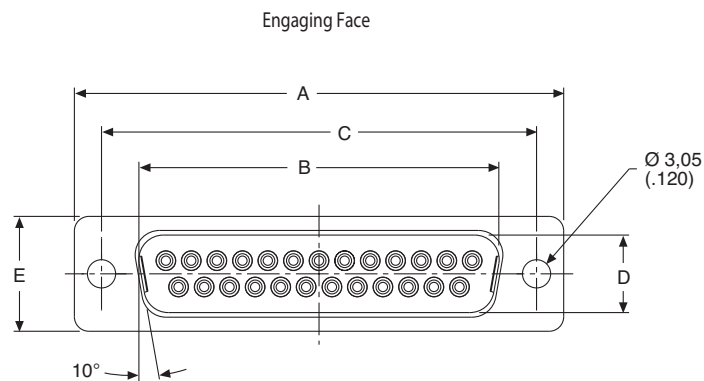

Size D

DD Configuration

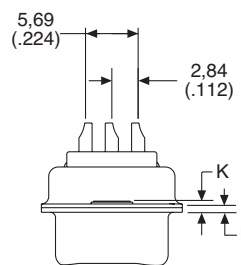

Sizes E, A, B, C

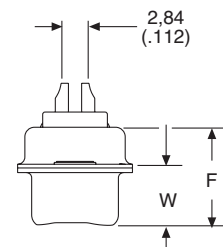

Dimensions

Shell size	A	B	C	D	E	F	W	W	K	K	L
	± 0,38 (.015)	± 0,13 (.005)	± 0,13 (.005)	± 0,13 (.005)	± 0,38 (.015)	± 0,25 (.010)	± 0,368 (.0145)	± 0,41 (.016)	± 0,317 (.0125)	± 0,25 (.010)	± 0,25 (.010)
DE	30,81 (1.213)	16,92 (.666)	24,99 (8,36)	8,36 (.329)	12,55 (.494)	10,72 (.422)	6,693 (.2635)	-	1,206 (.0475)	-	0,76 (.030)
DA	39,14 (1.541)	25,25 (.994)	33,32 (1.312)	8,36 (.329)	12,55 (.494)	10,72 (.422)	6,693 (.2635)	-	1,206 (.0475)	-	0,76 (.030)
DB	53,04 (2.088)	38,96 (1.534)	47,04 (1.852)	8,36 (.329)	12,55 (.494)	10,82 (.426)	-	6,84 (.269)	-	1,52 (.060)	0,99 (.039)
DC	69,32 (2.729)	55,42 (2.182)	63,50 (2.500)	8,36 (.329)	12,55 (.494)	10,82 (.426)	-	6,84 (.269)	-	1,52 (.060)	0,99 (.039)
DD	66,93 (2.635)	52,81 (2.079)	61,11 (2.406)	11,07 (.436)	15,37 (.605)	10,82 (.426)	-	6,84 (.269)	-	1,52 (.060)	0,99 (.039)

# Cannon Solder Cup, Size 20 Military/Hi-Reliability

## Solder Cup

### Receptacle

- For contact cavity arrangements, see pages C-44.
- For panel cutouts, see page C-49.
- Accepts up to 18 AWG.

Shell Size	Layout	Through Hole	Dual Float Mount
DE	9	DEM9S	DEMY9S
DA	15	DAM15S	DAMY15S
DB	25	DBM25S	DBMY25S
DC	37	DCM37S	DCMY37S
DD	50	DDM50S	DDMY50S

Note: For residual magnetism level of 200 Gamma and shells and contacts with 50 micro inches (1,27m) gold plating, add NMBK52. Example DEM9PNMBK52 and shells with 50 microinches gold for 50 microinch (1.27mm) gold contacts

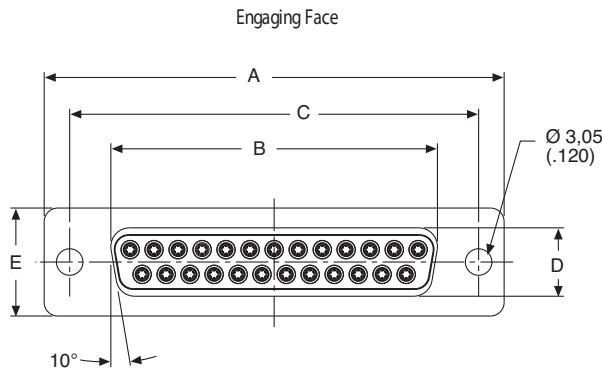

### Size D

#### DD Configuration

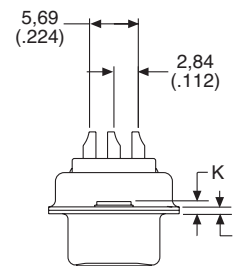

### Sizes E, A, B, C

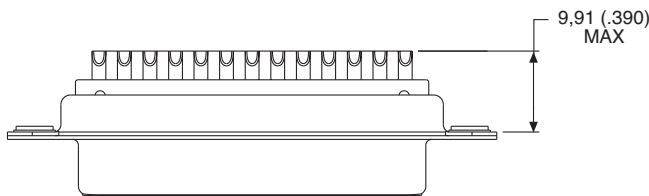
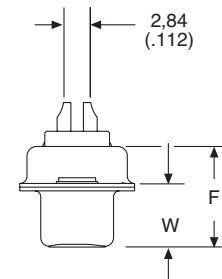

### Dimensions

Shell size	A ± 0,38 (.015)	B ± 0,13 (.005)	C ± 0,13 (.005)	D ± 0,13 (.005)	E ± 0,38 (.015)	F ± 0,25 (.010)	W ± 0,368 (.0145)	K ± 0,317 (.0125)	L ± 0,25 (.010)
DE	30,81 (1.213)	16,33 (.643)	24,99 (8,36)	7,90 (.311)	12,55 (.494)	10,90 (.429)	6,94 (.273)	1,206 (.0475)	0,76 (.030)
DA	39,14 (1.541)	24,66 (.971)	33,32 (1.312)	7,90 (.311)	12,55 (.494)	10,90 (.429)	6,94 (.273)	1,206 (.0475)	0,76 (.030)
DB	53,04 (2.088)	38,38 (1.511)	47,04 (1.852)	7,90 (.311)	12,55 (.494)	10,90 (.429)	6,94 (.273)	1,206 (.0475)	0,76 (.030)
DC	69,32 (2.729)	54,84 (2.159)	63,50 (2.500)	7,90 (.311)	12,55 (.494)	10,90 (.429)	6,94 (.273)	1,206 (.0475)	0,76 (.030)
DD	66,93 (2.635)	52,42 (2.064)	61,11 (2.406)	10,74 (.423)	15,37 (.605)	10,90 (.429)	6,94 (.273)	1,206 (.0475)	0,76 (.030)



Dimensions shown in inches (mm)  
Specifications and dimensions subject to change

www.ittcannon.com

## D\*MA Standard Density Crimp Contact Cable Connector

### Plug

- For contact cavity arrangements, see pages C-44.
- For panel cutouts, see page C-49.

Shell Size	Layout	Through Hole	Dual Float Mount
DE	9	DEMA9P	DEMAY9P
DA	14	DAMA15P	DAMAY15P
DB	25	DBMA25P	DBMAY25P
DC	37	DCMA37P	DCMAY37P
DD	50	DDMA50P	DDMAY50P

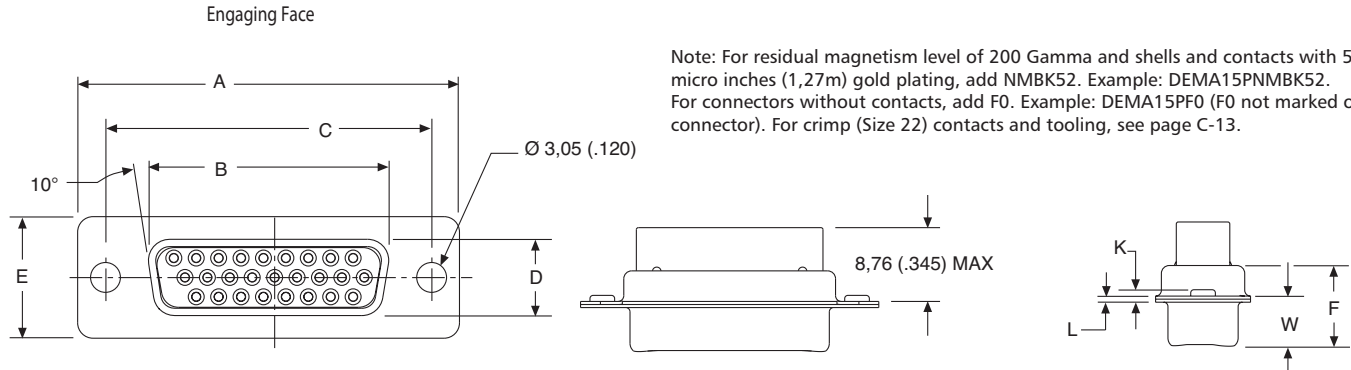

Note: For residual magnetism level of 200 Gamma and shells and contacts with 50 micro inches (1,27m) gold plating, add NMBK52. Example: DEMA15PNMBK52. For connectors without contacts, add F0. Example: DEMA15PF0 (F0 not marked on connector). For crimp (Size 22) contacts and tooling, see page C-13.

### Dimensions

Shell size	A ± 0,38 (.015)	B ± 0,13 (.005)	C ± 0,13 (.005)	D ± 0,13 (.005)	E ± 0,38 (.015)	F ± 0,25 (.010)	W ± 0,368 (.0145)	K ± 0,317 (.0125)	L ± 0,25 (.010)
DE	30,81 (1.213)	16,92 (.666)	24,99 (8,36)	8,36 (.329)	12,55 (.494)	10,90 (.429)	6,94 (.273)	1,206 (.0475)	0,76 (.030)
DA	39,14 (1.541)	25,25 (.994)	33,32 (1.312)	8,36 (.329)	12,55 (.494)	10,90 (.429)	6,94 (.273)	1,206 (.0475)	0,76 (.030)
DB	53,04 (2.088)	38,96 (1.534)	47,04 (1.852)	8,36 (.329)	12,55 (.494)	10,90 (.429)	6,94 (.273)	1,206 (.0475)	0,76 (.030)
DC	69,32 (2.729)	55,42 (2.182)	63,50 (2.500)	8,36 (.329)	12,55 (.494)	10,90 (.429)	6,94 (.273)	1,206 (.0475)	0,76 (.030)
DD	66,93 (2.635)	52,81 (2.079)	61,11 (2.406)	11,07 (.436)	15,37 (.605)	10,90 (.429)	6,94 (.273)	1,206 (.0475)	0,76 (.030)

### Receptacle

- For contact cavity arrangements, see pages C-44.
- For panel cutouts, see page C-49.

Shell Size	Layout	Through Hole	Dual Float Mount
DE	9	DEMA9S	DEMAY9S
DA	15	DAMA15S	DAMAY15S
DB	25	DBMA25S	DBMAY25S
DC	37	DCMA37S	DCMAY37S
DD	50	DDMA50S	DDMAY50S

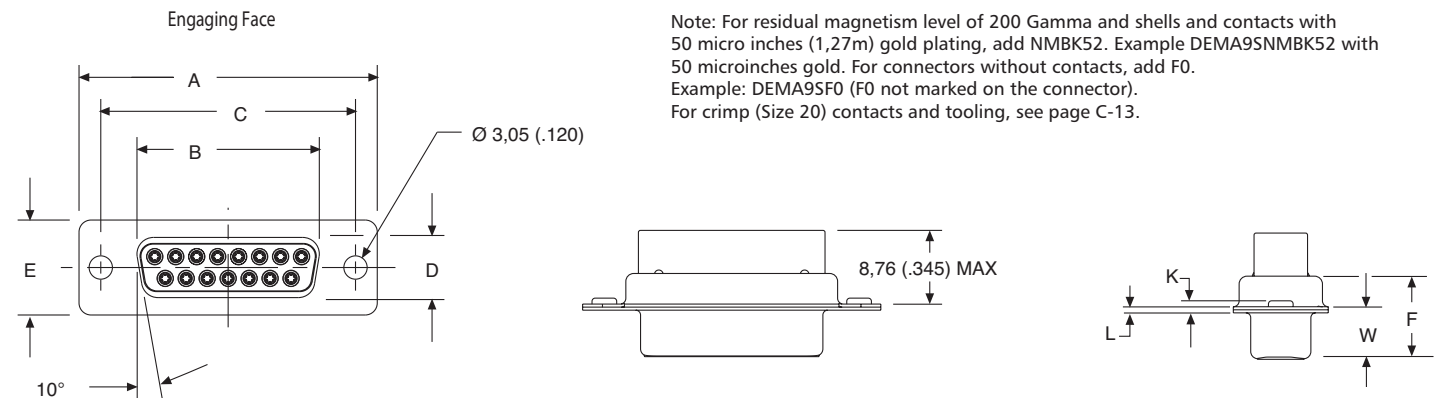

Note: For residual magnetism level of 200 Gamma and shells and contacts with 50 micro inches (1,27m) gold plating, add NMBK52. Example: DEMA9SNMBK52 with 50 microinches gold. For connectors without contacts, add F0. Example: DEMA9SF0 (F0 not marked on the connector). For crimp (Size 20) contacts and tooling, see page C-13.

### Dimensions

Shell size	A ± 0,38 (.015)	B ± 0,13 (.005)	C ± 0,13 (.005)	D ± 0,13 (.005)	E ± 0,38 (.015)	F ± 0,25 (.010)	W ± 0,368 (.0145)	K ± 0,317 (.0125)	L ± 0,25 (.010)
DE	30,81 (1.213)	16,33 (.643)	24,99 (.984)	7,90 (.311)	12,55 (.494)	10,90 (.429)	6,94 (.273)	1,206 (.0475)	0,76 (.030)
DA	39,14 (1.541)	24,66 (.971)	33,32 (1.312)	7,90 (.311)	12,55 (.494)	10,90 (.429)	6,94 (.273)	1,206 (.0475)	0,76 (.030)
DB	53,04 (2.088)	38,38 (1.511)	47,04 (1.852)	7,90 (.311)	12,55 (.494)	10,90 (.429)	6,94 (.273)	1,206 (.0475)	0,76 (.030)
DC	69,32 (2.729)	54,84 (2.159)	63,50 (2.500)	7,90 (.311)	12,55 (.494)	10,90 (.429)	6,94 (.273)	1,206 (.0475)	0,76 (.030)
DD	66,93 (2.635)	52,42 (2.064)	61,11 (2.406)	10,74 (.423)	15,37 (.605)	10,90 (.429)	6,94 (.273)	1,206 (.0475)	0,76 (.030)

Dimensions shown in inches (mm)  
Specifications and dimensions subject to change

www.ittcannon.com

# Cannon Crimp, Size 22 Military/High Reliability

## D\*MA High Density Crimp Contact Cable Connector

### Plug

- For contact cavity arrangements, see pages C-44.
- For panel cutouts, see page C-49.

Shell Size	Layout	Through Hole	Dual Float Mount
DE	15	DEMA15P	DEMAY15P
DA	26	DAMA26P	DAMAY26P
DB	44	DBMA44P	DBMAY44P
DC	62	DCMA62P	DCMAY62P
DD	78	DDMA78P	DDMAY78P
DF	104	DFMA104PF216	DFMA4104PF216

Engaging Face

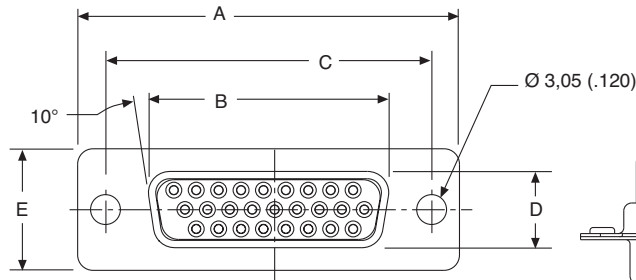

Note: For Residual Magnetism Level of 200 gamma, add B. Example DEMA15PNMB  
For shells with 50 microinches gold, add K52. Example: DEMA15PNMBK52.  
For connectors without contacts, add F0. Example: DEMA15PF0 (F0 not marked on connector)  
For crimp (Size 22) contacts and tooling, see page C-7.

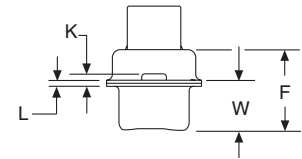
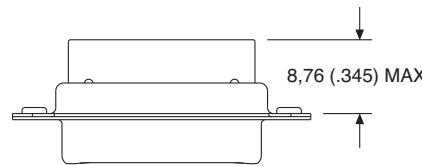

### Dimensions

Shell size	A	B	C	D	E	F	W	W	K	K	L
	± 0,38 (.015)	± 0,13 (.005)	± 0,13 (.005)	± 0,13 (.005)	± 0,38 (.015)	± 0,25 (.010)	± 0,368 (.0145)	± 0,41 (.016)	± 0,317 (.0125)	± 0,25 (.010)	± 0,25 (.010)
DE	30,81 (1.213)	16,92 (.666)	24,99 (.984)	8,36 (.329)	12,55 (.494)	10,72 (.422)	6,693 (.2635)	-	1,206 (.0475)	-	0,76 (.030)
DA	39,14 (1.541)	25,25 (.994)	33,32 (1.312)	8,36 (.329)	12,55 (.494)	10,72 (.422)	6,693 (.2635)	-	1,206 (.0475)	-	0,76 (.030)
DB	53,04 (2.088)	38,96 (1.534)	47,04 (1.852)	8,36 (.329)	12,55 (.494)	10,82 (.426)	-	6,84 (.269)	-	1,52 (.060)	0,99 (.039)
DC	69,32 (2.729)	55,42 (2.182)	63,50 (2.500)	8,36 (.329)	12,55 (.494)	10,82 (.426)	-	6,84 (.269)	-	1,52 (.060)	0,99 (.039)
DD	66,93 (2.635)	52,81 (2.079)	61,11 (2.406)	11,07 (.436)	15,37 (.605)	10,82 (.426)	-	6,84 (.269)	-	1,52 (.060)	0,99 (.039)

DF (see Space Catalog)

### Receptacle

- For contact cavity arrangements, see pages C-44.
- For panel cutouts, see page C-49.

Shell Size	Layout	Through Hole	Dual Float Mount
DE	15	DEMA15S	DEMAY15S
DA	26	DAMA26S	DAMAY26S
DB	44	DBMA44S	DBMAY44S
DC	62	DCMA62S	DCMAY62S
DD	78	DDMA78S	DDMAY78S
DF	104	DFMA104SF216	DFMA4104SF216

Engaging Face

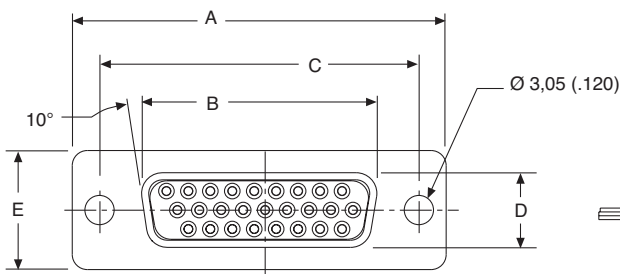

Note: For residual magnetism level of 200 Gamma and shells and contacts with 50 micro inches (1,27m) gold plating, add NMBK52. Example DEMA15SNMBK52  
contacts and shells with 50 microinches gold. For connectors without contacts, add F0. Example: DEMA15SF0 (F0 not marked on the connector). For crimp (Size 22) contacts and tooling, see page C-13.

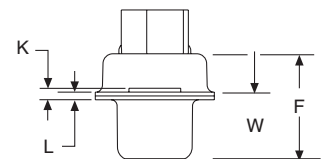
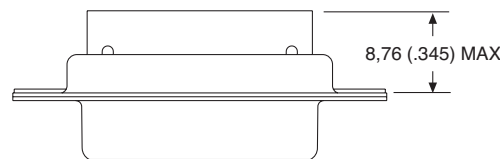

### Dimensions

Shell size	A	B	C	D	E	F	W	K	L
	± 0,38 (.015)	± 0,13 (.005)	± 0,13 (.005)	± 0,13 (.005)	± 0,38 (.015)	± 0,25 (.010)	± 0,368 (.0145)	± 0,317 (.0125)	± 0,25 (.010)
DE	30,81 (1.213)	16,33 (.643)	24,99 (8,36)	7,90 (.311)	12,55 (.494)	10,90 (.429)	6,94 (.273)	1,206 (.0475)	0,76 (.030)
DA	39,14 (1.541)	24,66 (.971)	33,32 (1.312)	7,90 (.311)	12,55 (.494)	10,90 (.429)	6,94 (.273)	1,206 (.0475)	0,76 (.030)
DB	53,04 (2.088)	38,38 (1.511)	47,04 (1.852)	7,90 (.311)	12,55 (.494)	10,90 (.429)	6,94 (.273)	1,206 (.0475)	0,76 (.030)
DC	69,32 (2.729)	54,84 (2.159)	63,50 (2.500)	7,90 (.311)	12,55 (.494)	10,90 (.429)	6,94 (.273)	1,206 (.0475)	0,76 (.030)
DD	66,93 (2.635)	52,42 (2.064)	61,11 (2.406)	10,74 (.423)	15,37 (.605)	10,90 (.429)	6,94 (.273)	1,206 (.0475)	0,76 (.030)



Dimensions shown in inches (mm)  
Specifications and dimensions subject to change

www.ittcannon.com

# Cannon Crimp Contacts D\*MA/D\*A Combo Military/High Reliability

## MATERIALS AND FINISHES

Contact Size	Wire Size Accom.	Standard Finish		Military Finish		NMB	
		Pin	Socket	Pin	Socket	Pin	Socket
20	20, 22, 24	330-5291-000	031-1007-073	980-0009-472	980-0009-471	330-5291-037	031-1007-052
20-18	1 #18 & 2 #22	330-5291-001	031-1007-001	330-5291-055	031-1007-054	330-5291-108	031-1007-091
20-26	26, 28, 30	330-5291-004	031-1007-004	330-5291-050	031-1007-048	330-5291-109	031-1007-053
22D	22, 24, 26, 28	980-0008-878	980-0008-874	980-0008-878	980-0008-874	030-2042-002	031-1147-002

## MIL-C-39029 Cross-Reference

Contact Size	Wire Size Accom.	M39029	M24308	Cannon Part No.
20 Pin	20 / 22 / 24	/ 64-369	/ 11-1	980-0009-472
20 Socket	20 / 22 / 24	/ 63-368	/ 10-1	980-0009-471
22D Pin	24 / 26 / 28	/ 58-360	/ 13-1	980-0008-878
22D Socket	22 / 24 / 26 / 28	/ 57-354	/ 12-1	980-0008-874

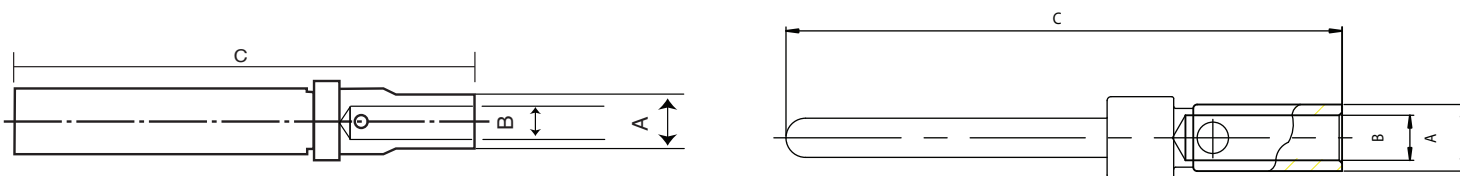

AWG size		A ± 0,05	B ± 0,05	C max.
20 – 24	Pin	1,7 (0.067)	1,0 (0.039)	14,2 (0.559)
	Socket	1,7 (0.067)	1,0 (0.039)	13,7 (0.539)
26 – 30	Pin	1,7 (0.067)	0,6 (0.039)	14,2 (0.559)
	Socket	1,7 (0.067)	0,6 (0.039)	13,7 (0.539)

## Insertion/Extraction Tools

### CIET-20HD

Contact Size	AWG	Plastic Insertion/Extraction		Plastic Extraction	
		Pin	Socket	Pin	Socket
20	20, 22, 24	980-2000-426	CIET-20HD	323-7010-000	CET-20-11
2026	26, 28, 30	980-2000-426	CIET-20HD	323-7010-000	CET-20-11
2018	1 #18	None	None	274-5016-002	CET-20-15
	2 #22	None	None	274-5016-002	CET-20-15
22D	22, 24, 26, 28	274-7048-000	CIET-22D	None	None
High Power	12, 16	274-7003-000	CIET-12	None	None
High Volt	#20	274-7003-000	CIET-12	None	None

## Hand Crimp Tools

Contact Size	Wire Size AWG	Crimp Tool		Locator	
		Part Number	Description	Part Number	Description
20	20, 22, 24	995-0001-584	M22520/2-01	995-0001-604	M22520/2-08
		995-0001-585	M22520/1-01	995-0001-244	TH25
2026	26, 28, 30	980-2000-426	M22520/2-01	995-0001-325	L3198-20HD
2018	1 #18, 2 #22	995-0001-584	M22520/2-01	980-0005-722	K250
22D	22, 24, 26, 28	995-0001-584	M22520/2-01	995-0001-739	M22520/2-06

Assembly instructions see page C-44.  
For size 8 contacts, please refer to Combo D catalog or website.

Dimensions shown in inches (mm)  
Specifications and dimensions subject to change

www.ittcannon.com

# Cannon Straight PCB, Size 20 Military/High Reliability

## Standard Density Straight PC Tail

### Plug

- For contact cavity arrangements, see pages C-44.
- For P.C. hole pattern, see pages C-45.
- For panel cutouts, see page C-49.

Shell Size	Layout	Through Hole	Dual Float Mount
DE	9	DEM9PM*	DEMY9PM*
DA	15	DAM15PM*	DAMY15PM*
DB	25	DBM25PM*	DBMY25PM*
DC	37	DCM37PM*	DCMY37PM*
DD	50	DDM50PM*	DDMY50PM*

Note: For Residual Magnetism Level of 200 gamma, add NMBK52. Example DEMA15PMNMBK52 contacts and shells with 50 microinches gold. For alternate PC tail modifiers (see tabulation), replace 0L3 with M or Z. Example: DEM9PZNM

PC Tail Modifiers	X	ØY
M	4.01 ± 0,69 (.158 ± .027)	0,76 ± 0,08 (.030 ± .003)
Q	7,62 ± 0,5 (.300 ± .020)	0,76 ± 0,08 (.030 ± .003)
0L3	4,82 ± 1,5 (.190 ± .020)	0,60 ± 0,08 (.023 ± .003)

0L3 for HE501 connectors and ESA equivalents

### Size D

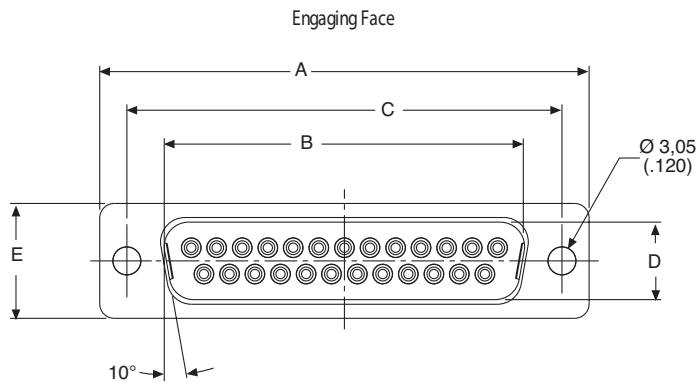

### DD Configuration

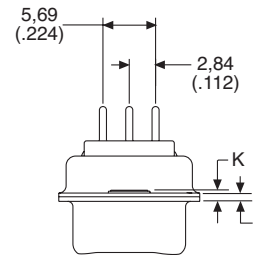

### Sizes E, A, B, C

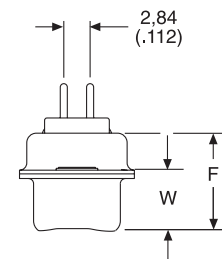
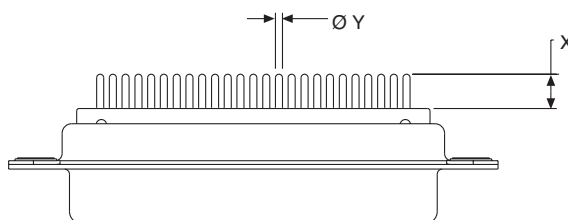

### Dimensions

Shell size	A	B	C	D	E	F	W	W	K	K	L
	± 0,38 (.015)	± 0,13 (.005)	± 0,13 (.005)	± 0,13 (.005)	± 0,38 (.015)	± 0,25 (.010)	± 0,368 (.0145)	± 0,41 (.016)	± 0,317 (.0125)	± 0,25 (.010)	± 0,25 (.010)
DE	30,81 (1.213)	16,92 (.666)	24,99 (8,36)	8,36 (.329)	12,55 (.494)	10,72 (.422)	6,693 (.2635)	-	1,206 (.0475)	-	0,76 (.030)
DA	39,14 (1.541)	25,25 (.994)	33,32 (1.312)	8,36 (.329)	12,55 (.494)	10,72 (.422)	6,693 (.2635)	-	1,206 (.0475)	-	0,76 (.030)
DB	53,04 (2.088)	38,96 (1.534)	47,04 (1.852)	8,36 (.329)	12,55 (.494)	10,82 (.426)	-	6,84 (.269)	-	1,52 (.060)	0,99 (.039)
DC	69,32 (2.729)	55,42 (2.182)	63,50 (2.500)	8,36 (.329)	12,55 (.494)	10,82 (.426)	-	6,84 (.269)	-	1,52 (.060)	0,99 (.039)
DD	66,93 (2.635)	52,81 (2.079)	61,11 (2.406)	11,07 (.436)	15,37 (.605)	10,82 (.426)	-	6,84 (.269)	-	1,52 (.060)	0,99 (.039)



Dimensions shown in inches (mm)  
Specifications and dimensions subject to change

www.ittcannon.com

## Standard Density Straight PC Tail

### Receptacle

- For contact cavity arrangements, see pages C-44.
- For P.C. hole pattern, see pages C-45.
- For panel cutouts, see page C-49.

Shell Size	Layout	Through Hole	Dual Float Mount
DE	9	DEM9SM	DEMYSM
DA	15	DAM15SM	DAMY15SM
DB	25	DBM25SM	DBMY25SM
DC	37	DCM37SM	DCMY37SM
DD	50	DDM50SM	DDMY50SM

PC Tail Modifiers	X	Y
M	4,01 ± 0,69 (.158 ± .027)	0,76 ± 0,08 (.030 ± .003)
Q	7,62 ± 0,5 (.300 ± .020)	0,76 ± 0,08 (.030 ± .003)
OL3	4,82 ± 1,5 (.190 ± .020)	0,60 ± 0,08 (.023 ± .003)

Note: For residual magnetism level of 200 Gamma and shells and contacts with 50 micro inches (1,27m) gold plating, add NMBK52. Example DEMA15SMNMBK52 and shells with 50 microinches gold. For alternate PC tail modifiers (see tabulation), replace with OL3 or Z. Example: DEM9SZNM

OL3 for HE501 connectors and ESA equivalents

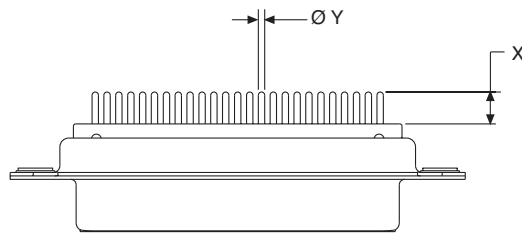
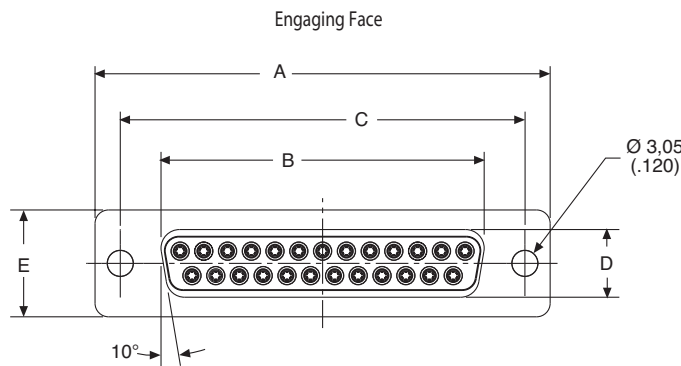

### Size D

#### DD Configuration

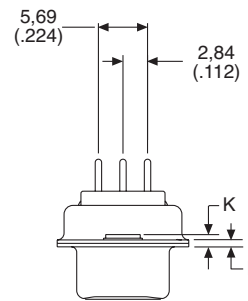

#### Sizes E, A, B, C

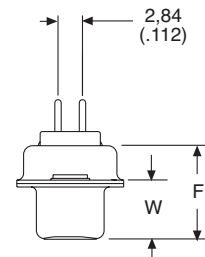

### Dimensions

Shell size	A ± 0,38 (.015)	B ± 0,13 (.005)	C ± 0,13 (.005)	D ± 0,13 (.005)	E ± 0,38 (.015)	F ± 0,25 (.010)	W ± 0,368 (.0145)	K ± 0,317 (.0125)	L ± 0,25 (.010)
DE	30,81 (1.213)	16,33 (.643)	24,99 (8,36)	7,90 (.311)	12,55 (.494)	10,90 (.429)	6,94 (.273)	1,206 (.0475)	0,76 (.030)
DA	39,14 (1.541)	24,66 (.971)	33,32 (1.312)	7,90 (.311)	12,55 (.494)	10,90 (.429)	6,94 (.273)	1,206 (.0475)	0,76 (.030)
DB	53,04 (2.088)	38,38 (1.511)	47,04 (1.852)	7,90 (.311)	12,55 (.494)	10,90 (.429)	6,94 (.273)	1,206 (.0475)	0,76 (.030)
DC	69,32 (2.729)	54,84 (2.159)	63,50 (2.500)	7,90 (.311)	12,55 (.494)	10,90 (.429)	6,94 (.273)	1,206 (.0475)	0,76 (.030)
DD	66,93 (2.635)	52,42 (2.064)	61,11 (2.406)	10,74 (.423)	15,37 (.605)	10,90 (.429)	6,94 (.273)	1,206 (.0475)	0,76 (.030)

Dimensions shown in inches (mm)  
Specifications and dimensions subject to change

www.ittcannon.com



# Cannon Straight PCB, High Density Plug Military/High Reliability D-Subminiature

## High Density Straight PC Tail

### Plug

- For contact cavity arrangements, see pages C-44.
- For P.C. hole pattern, see pages C-47.
- For panel cutouts, see page C-49.

Shell Size	Layout	Through Hole	Dual Float Mount
DE	15	DEM15PM*	DEMY15PM*
DA	26	DAM26PM*	DAMY26PM*
DB	44	DBM44PM*	DBMY44PM*
DC	62	DCM62PM*	DCMY62PM*
DD	78	DDM78PM*	DDMY78PM*

PC Tail Modifiers	X
M	4,01 ± 0,69 (.158 ± .027)
Q	7,62 ± 0,5 (.300 ± .020)
OL3	4,82 ± 1,5 (.190 ± .020)

Note: For Residual Magnetism Level of 200 gamma, add NMBK52. Example DEMA15PMNMBK52 and shells with 50 microinches gold. For alternate PC tail modifiers (see tabulation), replace with OL3 or Z. Example: DEM15PZNM

OL3 for HE501 connectors and ESA equivalents

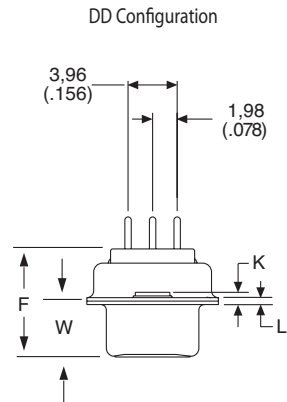
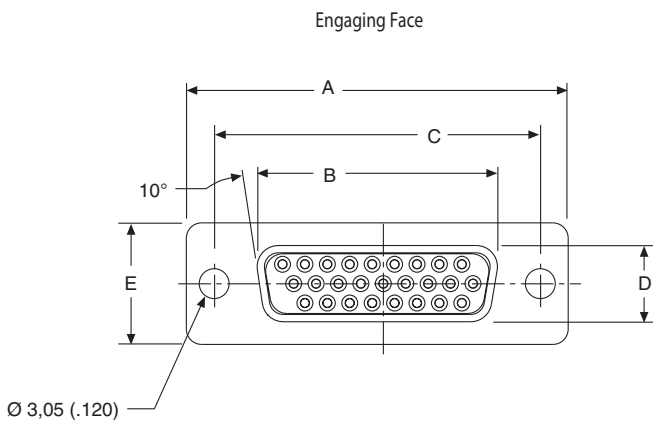

Note: D size connectors have 4 rows of contacts  
F size connectors have 5 rows of contacts

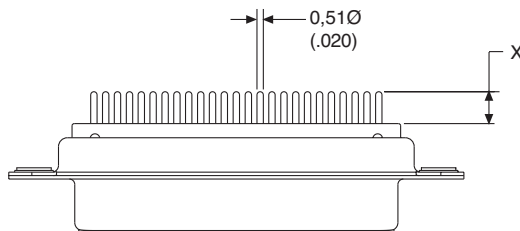

### Dimensions

Shell size	A	B	C	D	E	F	W	W	K	K	L
	± 0,38 (.015)	± 0,13 (.005)	± 0,13 (.005)	± 0,13 (.005)	± 0,38 (.015)	± 0,25 (.010)	± 0,368 (.0145)	± 0,41 (.016)	± 0,317 (.0125)	± 0,25 (.010)	± 0,25 (.010)
DE	30,81 (1.213)	16,92 (.666)	24,99 (8,36)	8,36 (.329)	12,55 (.494)	10,72 (.422)	6,693 (.2635)	-	1,206 (.0475)	-	0,76 (.030)
DA	39,14 (1.541)	25,25 (.994)	33,32 (1.312)	8,36 (.329)	12,55 (.494)	10,72 (.422)	6,693 (.2635)	-	1,206 (.0475)	-	0,76 (.030)
DB	53,04 (2.088)	38,96 (1.534)	47,04 (1.852)	8,36 (.329)	12,55 (.494)	10,82 (.426)	-	6,84 (.269)	-	1,52 (.060)	0,99 (.039)
DC	69,32 (2.729)	55,42 (2.182)	63,50 (2.500)	8,36 (.329)	12,55 (.494)	10,82 (.426)	-	6,84 (.269)	-	1,52 (.060)	0,99 (.039)
DD	66,93 (2.635)	52,81 (2.079)	61,11 (2.406)	11,07 (.436)	15,37 (.605)	10,82 (.426)	-	6,84 (.269)	-	1,52 (.060)	0,99 (.039)
DF	69,34 (2.73)	55,0 (2.16)	63,50 (2.50)	15,49 (0.61)	20,07 (0.79)	16,45 (.648)	6,94 (.273)	1,206 (.0475)	0,76 (.030)	-	-



Dimensions shown in inches (mm)  
Specifications and dimensions subject to change

www.ittcannon.com

## High Density Straight PC Tail

### Receptacle

- For contact cavity arrangements, see pages C-44.
- For P.C. hole pattern, see pages C-47.
- For panel cutouts, see page C-49.

Shell Size	Layout	Through Hole	Dual Float Mount
DE	15	DEMA15SM	DEMAY15SM
DA	26	DAMA26SM	DAMAY26SM
DB	44	DBMA26SM	DBMAY44SM
DC	62	DCMA62SM	DCMAY62SM
DD	78	DDMA78SM	DDMAY78SM
DF*	104	DFMA104SM	DFMAY104SM

PC Tail Modifiers	X
M	4.01 ± 0,69 (.158 ± .027)
Q	7,62 ± 0,5 (.300 ± .020)
0L3	4,82 ± 1,5 (.190 ± .020)

Note: For residual magnetism level of 200 Gamma and shells and contacts with 50 micro inches (1,27m) gold plating, add NMBK52. Example DEMA15SMNMBK52 and shells with 50 microinches gold. For alternate PC tail modifiers (see tabulation), replace 0L3 with M or Z. Example: DEM9SZNM

0L3 for HE501 connectors and ESA equivalents

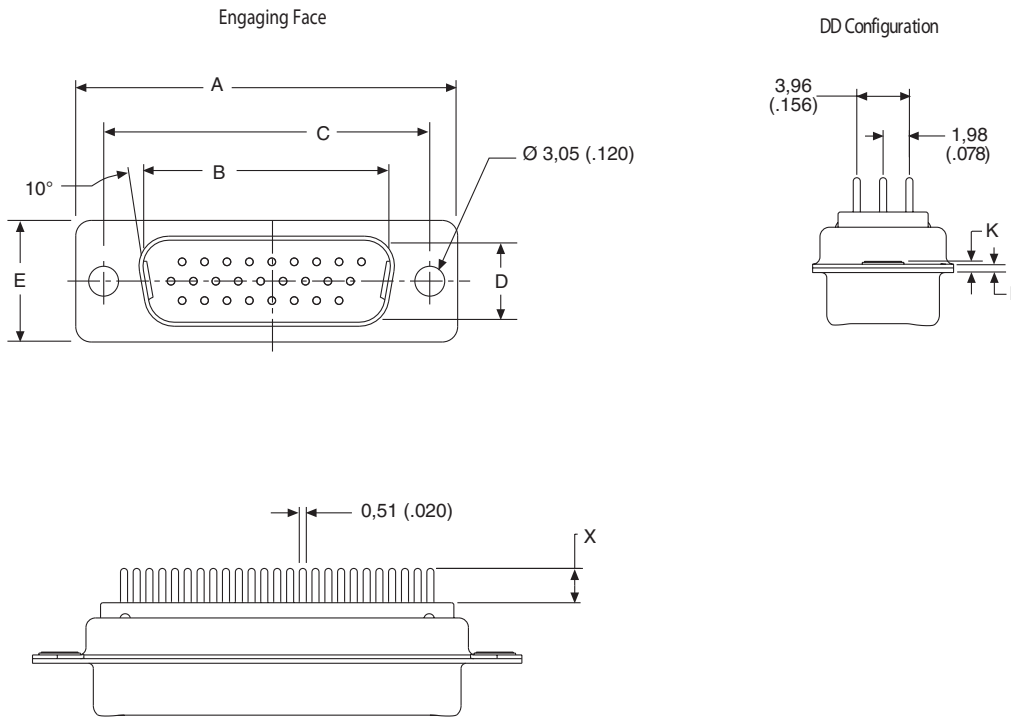

### Dimensions

Shell size	A ± 0,38 (.015)	B ± 0,13 (.005)	C ± 0,13 (.005)	D ± 0,13 (.005)	E ± 0,38 (.015)	F ± 0,25 (.010)	W ± 0,368 (.0145)	K ± 0,317 (.0125)	L ± 0,25 (.010)
DE	30,81 (1.213)	16,33 (.643)	24,99 (8,36)	7,90 (.311)	12,55 (.494)	10,90 (.429)	6,94 (.273)	1,206 (.0475)	0,76 (.030)
DA	39,14 (1.541)	24,66 (.971)	33,32 (1.312)	7,90 (.311)	12,55 (.494)	10,90 (.429)	6,94 (.273)	1,206 (.0475)	0,76 (.030)
DB	53,04 (2.088)	38,38 (1.511)	47,04 (1.852)	7,90 (.311)	12,55 (.494)	10,90 (.429)	6,94 (.273)	1,206 (.0475)	0,76 (.030)
DC	69,32 (2.729)	54,84 (2.159)	63,50 (2.500)	7,90 (.311)	12,55 (.494)	10,90 (.429)	6,94 (.273)	1,206 (.0475)	0,76 (.030)
DD	66,93 (2.635)	52,42 (2.064)	61,11 (2.406)	10,74 (.423)	15,37 (.605)	10,90 (.429)	6,94 (.273)	1,206 (.0475)	0,76 (.030)
DF	69.34 (2.73)	55,0 (2.16)	63,50 (2.50)	15,49 (0.61)	20,07 (0.79)	16,45 (.648)	6,94 (.273)	1,206 (.0475)	0,76 (.030)

Dimensions shown in inches (mm)  
Specifications and dimensions subject to change

# Cannon 90° PCB, Size 20 Military/High Reliability

## 90° Standard Density PC Tail

### Plug

- For contact cavity arrangements, see pages C-44.
- For P.C. hole pattern, see pages C-46.
- For panel cutouts, see page C-49.

Shell Size	Layout	Through Hole with bracket	Through Hole without bracket
DE	9	DEMM9PL	DEMM9P
DA	15	DAMM15PL	DEMM15P
DB	25	DBMM25PL	DEMM25P
DC	37	DCMM37PL	DEMM37P
DD	50	DDMM50PL	DEMM50P

Note: For Residual Magnetism Level of 200 gamma, add NMBK52.  
Example DEMA9PLNMBK52 contacts and shells have 50 microinches gold.  
Shown with bracket, for version without bracket, use termination modifier "P".

### Size D

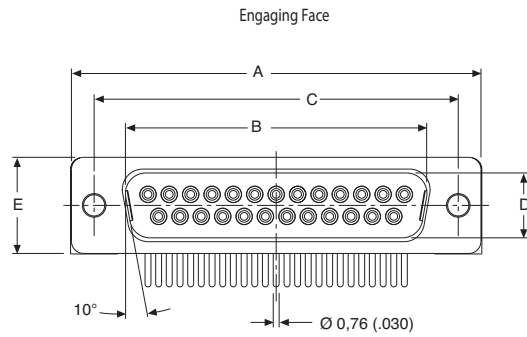

### DD Configuration

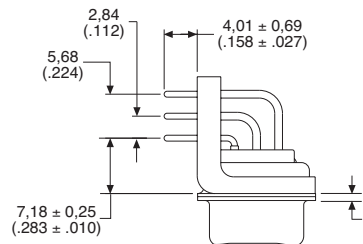

### Size E, A, B, C

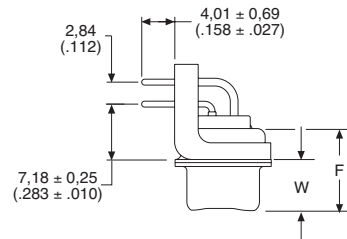
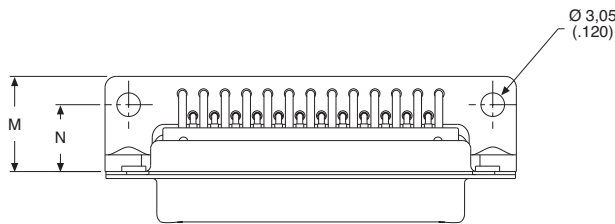

Shell size	A	B	C	D	E	F	W	W	K	K	L
	± 0,38 (.015)	± 0,13 (.005)	± 0,13 (.005)	± 0,13 (.005)	± 0,38 (.015)	± 0,25 (.010)	± 0,368 (.0145)	± 0,41 (.016)	± 0,317 (.0125)	± 0,25 (.010)	± 0,25 (.010)
DE	30,81 (1.213)	16,92 (.666)	24,99 (8,36)	8,36 (.329)	12,55 (.494)	10,72 (.422)	6,693 (.2635)	-	0,76 (.030)	12,30 (.484)	8,64 (.340)
DA	39,14 (1.541)	25,25 (.994)	33,32 (1.312)	8,36 (.329)	12,55 (.494)	10,72 (.422)	6,693 (.2635)	-	0,76 (.030)	12,30 (.484)	8,64 (.340)
DB	53,04 (2.088)	38,96 (1.534)	47,04 (1.852)	8,36 (.329)	12,55 (.494)	10,82 (.426)	-	6,84 (.269)	0,76 (.030)	12,30 (.484)	8,64 (.340)
DC	69,32 (2.729)	55,42 (2.182)	63,50 (2.500)	8,36 (.329)	12,55 (.494)	10,82 (.426)	-	6,84 (.269)	0,76 (.030)	12,30 (.484)	8,64 (.340)
DD	66,93 (2.635)	52,81 (2.079)	61,11 (2.406)	11,07 (.436)	15,37 (.605)	10,82 (.426)	-	6,84 (.269)	0,76 (.030)	15,09 (.594)	10,04 (.395)



Dimensions shown in inches (mm)  
Specifications and dimensions subject to change

## 90° High Density Plug PC Tail with Plastic Bracket

### Plug

- For contact cavity arrangements, see pages C-44.
- For P.C. hole pattern, see pages C-48.
- For panel cutouts, see page C-49.

Shell Size	Layout	Through Hole with bracket
DE	15	DEMA15PL
DA	26	DAMA26PL
DB	44	DBMA44PL
DC	62	DCMA62PL
DD	78	DDMA78PL
DF	104	DFMA104PLF216

Note: For Residual Magnetism Level of 200 gamma, add NMBK52. Example DEMA15PLNMBK52 contacts and shells have 50 microinches gold. Shown with bracket, for version without bracket, use termination modifier "P". "F" size shells use machined aluminum shells only.

### Size D

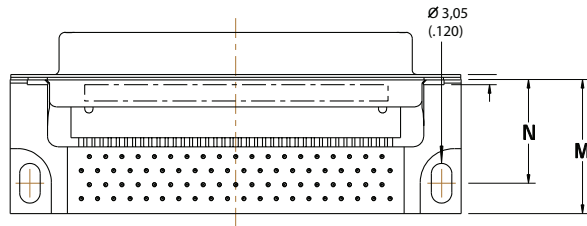
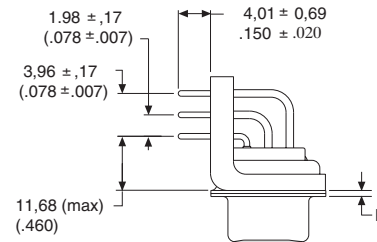
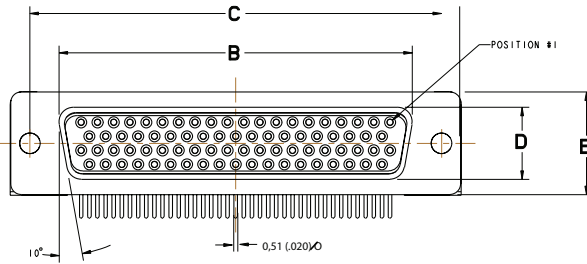

Shell size	A	B	C	D	E	F	W	W	K	M	N
	± 0,38 (.015)	± 0,13 (.005)	± 0,13 (.005)	± 0,13 (.005)	± 0,38 (.015)	± 0,25 (.010)	± 0,368 (.0145)	± 0,41 (.016)	± 0,317 (.0125)	± 0,25 (.010)	± 0,25 (.010)
DE	30,81 (1.213)	16,92 (.666)	24,99 (8,36)	8,36 (.329)	12,55 (.494)	10,72 (.422)	6,693 (.2635)	-	0,76 (.030)	18,901 (.740)	13,82 (.544)
DA	39,14 (1.541)	25,25 (.994)	33,32 (1.312)	8,36 (.329)	12,55 (.494)	10,72 (.422)	6,693 (.2635)	-	0,76 (.030)	18,901 (.740)	13,82 (.544)
DB	53,04 (2.088)	38,96 (1.534)	47,04 (1.852)	8,36 (.329)	12,55 (.494)	10,82 (.426)	-	6,84 (.269)	0,76 (.030)	18,901 (.740)	13,82 (.544)
DC	69,32 (2.729)	55,42 (2.182)	63,50 (2.500)	8,36 (.329)	12,55 (.494)	10,82 (.426)	-	6,84 (.269)	0,76 (.030)	18,901 (.740)	13,82 (.544)
DD	66,93 (2.635)	52,81 (2.079)	61,11 (2.406)	11,07 (.436)	15,37 (.605)	10,82 (.426)	-	6,84 (.269)	0,76 (.030)	20,07 (.790)	15,39 (.606)
DF	69,32 (2.729)	56,69 (2.232)	63,50 (2.500)	13,23 (.521)	16,97 (.668)	10,90 (.429)	-	6,94 (.273)	0,76 (.030)	22,14 (.872)	15,60 (.614)

Dimensions shown in inches (mm)  
Specifications and dimensions subject to change



# Cannon 90° PCB, High Density Receptacle Military/High Reliability D-Subminiatures

## 90° High Density PC Tail with Plastic Bracket

### Receptacle

- For contact cavity arrangements, see pages C-44.
- For P.C. hole pattern, see pages C-48.
- For panel cutouts, see page C-49.

Shell Size	Layout	Through Hole
DE	15	DEMA15SL
DA	26	DAMA26SL
DB	44	DBMA44SL
DC	62	DCMMA62SL
DD	76	DDMMA78SL
DF	104	DFMA104SLF216

Note: For Residual Magnetism Level of 200 gamma, add NMBK52.  
Example DEMA15SLNMBK52 contacts and shells have 50 microinches gold.  
Shown with bracket. For version without bracket use termination modifier "P".  
"F" size shells use machined aluminum shells only.

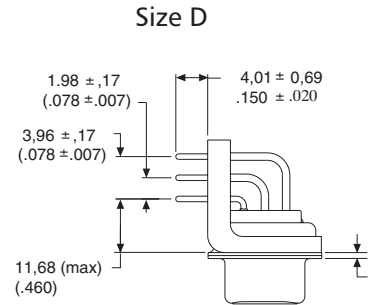
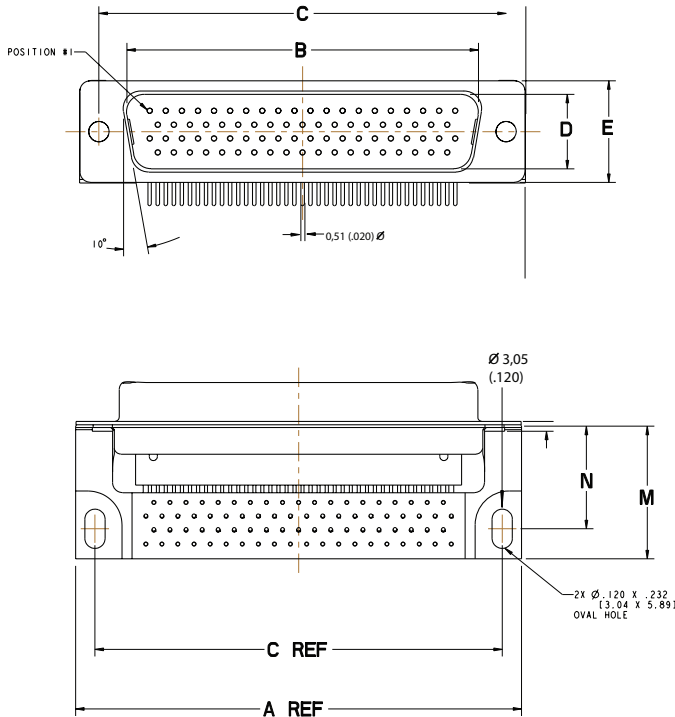

### Dimensions

Shell size	A ± 0,38 (.015)	B ± 0,13 (.005)	C ± 0,13 (.005)	D ± 0,13 (.005)	E ± 0,38 (.015)	F ± 0,25 (.010)	W ± 0,368 (.0145)	L ± 0,25 (.010)	M ± 0,25 (.010)	N ± 0,13 (.005)
DE	30,81 (1.213)	16,33 (.643)	24,99 (8,36)	7,90 (.311)	12,55 (.494)	10,90 (.429)	6,94 (.273)	0,76 (.030)	18,90 (.740)	13,82 (.544)
DA	39,14 (1.541)	24,66 (.971)	33,32 (1.312)	7,90 (.311)	12,55 (.494)	10,90 (.429)	6,94 (.273)	0,76 (.030)	18,90 (.740)	13,82 (.544)
DB	53,04 (2.088)	38,38 (1.511)	47,04 (1.852)	7,90 (.311)	12,55 (.494)	10,90 (.429)	6,94 (.273)	0,76 (.030)	18,90 (.740)	13,82 (.544)
DC	69,32 (2.729)	54,84 (2.159)	63,50 (2.500)	7,90 (.311)	12,55 (.494)	10,90 (.429)	6,94 (.273)	0,76 (.030)	18,90 (.740)	13,82 (.544)
DD	66,93 (2.635)	52,42 (2.064)	61,11 (2.406)	10,74 (.423)	15,37 (.605)	10,90 (.429)	6,94 (.273)	0,76 (.030)	20,07 (.790)	15,39 (.606)
DF	69,32 (2.729)	56,69 (2.232)	63,50 (2.500)	13,23 (.521)	16,97 (.668)	10,90 (.429)	6,94 (.273)	0,76 (.030)	22,14 (.872)	15,60 (.614)



Dimensions shown in inches (mm)  
Specifications and dimensions subject to change

Plug, Solder cup, sizes DE-DC, with empty size 8 cavities

Plug

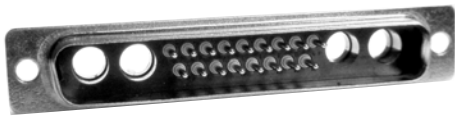

- For contact cavity arrangements, see page C-43.
- Size 8 contacts, please refer to Combo D catalog.

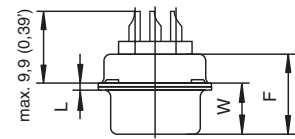
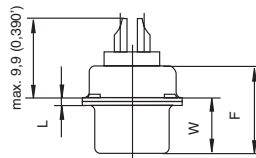
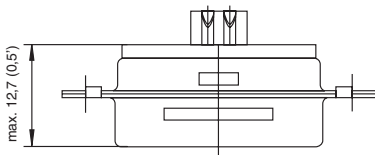
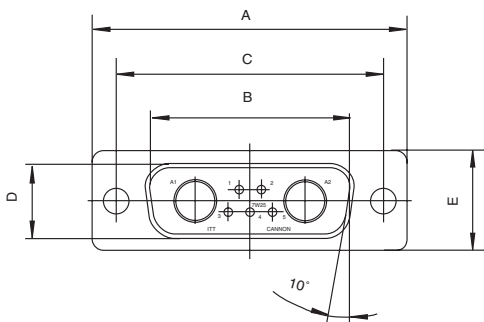

Empty size 8 contact cavities with solder pot termination

Shell size	Layout	INDUSTRIAL P/N with through hole	MILITARY/HI-REL P/N with through hole	NON-MAGNETIC/LOW OUTGASSING** P/N with through hole
DE	2W2	DEM2W2PK87	DEMM2W2P	DEM2W2PNMBK52
DE	2WK2	DEM2WK2PK87	DEMM2WK2P	DEM2WK2PNMBK52
DE	5W1	DEM5W1PK87	DEMM5W1P	DEM5W1PNMBK52
DA	7W2	DAM7W2PK87	DAMM7W2P	DAM7W2PNMBK52
DA	11W1	DAM11W1PK87	DAMM11W1P	DAM11W1PNMBK52
DA	3W3	DAM3W3PK87	DAMM3W3P	DAM3W3PNMBK52
DA	3WK3	DAM3WK3PK87	DAMM3WK3P	DAM3WK3PNMBK52
DB	5W5	DBM5W5PK87	DBMM5W5P	DBM5W5PNMBK52
DB	9W4	DBM9W4PK87	DBMM9W4P	DBM9W4PNMBK52
DB	13W3	DBM13W3PK87	DBMM13W3P	DBM13W3PNMBK52
DB	17W2	DBM17W2PK87	DBMM17W2P	DBM17W2PNMBK52
DB	21W1	DBM21W1PK87	DBMM21W1P	DBM21W1PNMBK52
DC	8W8	DCM8W8PK87	DCMM8W8P	DCM8W8PNMBK52
DC	13W6	DCM13W6PK87	DCMM13W6P	DCM13W6PNMBK52
DC	17W5	DCM17W5PK87	DCMM17W5P	DCM17W5PNMBK52
DC	21WA4	DCM21WA4PK87	DCMM21WA4P	DCM21WA4PNMBK52
DC	25W3	DCM25W3PK87	DCMM25W3P	DCM25W3PNMBK52
DC	27W2	DCM27W2PK87	DCMM27W2P	DCM27W2PNMBK52
DD	24W1	DDM24W1SA197	DDMM24W1S	DDM24W1SNMBK52
DD	36W4	DDM36W4SA197	DDMM36W4S	DDM36W4SNMBK52
DD	43W2	DDM43W2SA197	DDMM43W2S	DDM43W2SNMBK52
DD	47W1	DDM47W1SA197	DDMM47W1S	DDM47W1SNMBK52

\*For clinch nut 4-40 UNC thread add "E", for float mount add "Y" after D\*M designation (Ex. DCMME27W2P, DGM27W2PK87) 2W2/2WK2, 3W3/3WK3 (keyed) 5W5 and 8W8 without signal contacts.

\*\* Hardware Modifier not allowed on Non-Magnetic/Low Outgassing Versions; consult factory for more information

Dimensions

Shell size	A	B	C	D	E	F	W	W	K	K	L
	± 0,38 (.015)	± 0,13 (.005)	± 0,13 (.005)	± 0,13 (.005)	± 0,38 (.015)	± 0,25 (.010)	± 0,368 (.0145)	± 0,41 (.016)	± 0,317 (.0125)	± 0,25 (.010)	± 0,25 (.010)
DE	30,81 (1.213)	16,92 (.666)	24,99 (.984)	8,36 (.329)	12,55 (.494)	10,72 (.422)	6,693 (.2635)	—	1,206 (.0475)	—	0,76 (.030)
DA	39,14 (1.541)	25,25 (.994)	33,32 (1.312)	8,36 (.329)	12,55 (.494)	10,72 (.422)	6,693 (.2635)	—	1,206 (.0475)	—	0,76 (.030)
DB	53,04 (2.088)	38,96 (1.534)	47,04 (1.852)	8,36 (.329)	12,55 (.494)	10,82 (.426)	—	6,84 (.269)	—	1,52 (.060)	0,99 (.039)
DC	69,32 (2.729)	55,42 (2.182)	63,50 (2.500)	8,36 (.329)	12,55 (.494)	10,82 (.426)	—	6,84 (.269)	—	1,52 (.060)	0,99 (.039)
DF	66,93 (2.635)	51,81 (2.079)	61,11 (2.406)	11,07 (.436)	15,37 (.605)	10,82 (.426)	—	6,84 (.269)	—	1,52 (.060)	0,99 (.039)

Dimensions shown in inches (mm)  
Specifications and dimensions subject to change

# Cannon Combo-D, Solder Cup Military/High Reliability

## Receptacle, Solder cup, sizes DE-DC, with empty size 8 cavities

### Receptacle

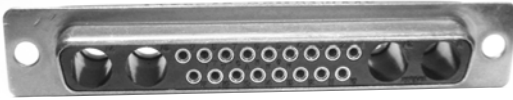

- For contact cavity arrangements, see page C-43.
- Size 8 contacts, please refer to Combo D catalog.

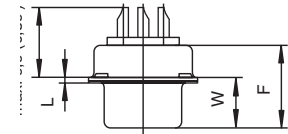
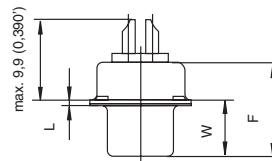
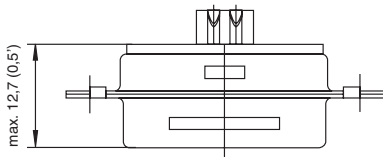
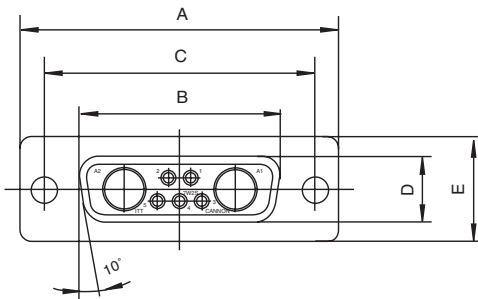

### Empty size 8 contact cavities with solder pot termination

Shell size	Layout	INDUSTRIAL P/N with through hole	MILITARY/HI-REL P/N with through hole	NON-MAGNETIC/LOW OUTGASSING** P/N with through hole
DE	2W2	DEM2W2SA197	DEMM2W2S	DEM2W2SNMBK52
DE	2WK2	DEM2WK2SA197	DEMM2WK2S	DEM2WK2SNMBK52
DE	5W1	DEM5W1SA197	DEMM5W1S	DEM5W1SNMBK52
DA	7W2	DAM7W2SA197	DAMM7W2S	DAM7W2SNMBK52
DA	11W1	DAM11W1SA197	DAMM11W1S	DAM11W1SNMBK52
DA	3W3	DAM3W3SA197	DAMM3W3S	DAM3W3SNMBK52
DA	3WK3	DAM3WK3SA197	DAMM3WK3S	DAM3WK3SNMBK52
DB	5W5	DBM5W5SA197	DBMM5W5S	DBM5W5SNMBK52
DB	9W4	DBM9W4SA197	DBMM9W4S	DBM9W4SNMBK52
DB	13W3	DBM13W3SA197	DBMM13W3S	DBM13W3SNMBK52
DB	17W2	DBM17W2SA197	DBMM17W2S	DBM17W2SNMBK52
DB	21W1	DBM21W1SA197	DBMM21W1S	DBM21W1SNMBK52
DC	8W8	DCM8W8SA197	DCMM8W8S	DCM8W8SNMBK52
DC	13W6	DCM13W6SA197	DCMM13W6S	DCM13W6SNMBK52
DC	17W5	DCM17W5SA197	DCMM17W5S	DCM17W5SNMBK52
DC	21WA4	DCM21WA4SA197	DCMM21WA4S	DCM21WA4SNMBK52
DC	25W3	DCM25W3SA197	DCMM25W3S	DCM25W3SNMBK52
DC	27W2	DCM27W2SA197	DCMM27W2S	DCM27W2SNMBK52
DD	24W1	DDM24W1SA197	DDMM24W1S	DDM24W1SNMBK52
DD	36W4	DDM36W4SA197	DDMM36W4S	DDM36W4SNMBK52
DD	43W2	DDM43W2SA197	DDMM43W2S	DDM43W2SNMBK52
DD	47W1	DDM47W1SA197	DDMM47W1S	DDM47W1SNMBK52

\*For clinch nut 4-40 UNC thread add "E", for float mount add "V" after D\*M designation  
(Ex. DCMME27W2P, DGM27W2PK87) 2W2/2WK2, 3W3/3WK3 (keyed) 5W5 and 8W8 without signal contacts.

\*\* Hardware Modifier not allowed on Non-Magnetic/Low Outgassing Versions; consult factory for more information

### Dimensions

Shell size	A ± 0,38 (.015)	B ± 0,13 (.005)	C ± 0,13 (.005)	D ± 0,13 (.005)	E ± 0,38 (.015)	F ± 0,25 (.010)	W ± 0,38 (.015)	K ± 0,317 (.0125)	L ± 0,25 (.010)
DE	30,81 (1.213)	16,33 (.643)	24,99 (.984)	7,90 (.311)	12,55 (.494)	10,90 (.429)	6,94 (.273)	1,206 (.0475)	0,76 (.030)
DA	39,14 (1.541)	24,65 (.971)	33,32 (1.312)	7,90 (.311)	12,55 (.494)	10,90 (.429)	6,94 (.273)	1,206 (.0475)	0,76 (.030)
DB	53,04 (2.088)	38,38 (1.511)	47,04 (1.852)	7,90 (.311)	12,55 (.494)	10,90 (.429)	6,94 (.273)	1,206 (.0475)	0,76 (.030)
DC	69,32 (2.729)	54,84 (2.159)	63,50 (2.500)	7,90 (.311)	12,55 (.494)	10,90 (.429)	6,94 (.273)	1,206 (.0475)	0,76 (.030)
DD	66,93 (2.635)	52,42 (2.064)	61,11 (2.406)	10,74 (.423)	15,37 (.605)	10,90 (.429)	6,94 (.273)	1,206 (.0475)	0,76 (.030)



Dimensions shown in inches (mm)  
Specifications and dimensions subject to change

www.ittcannon.com



Coaxial Straight PCB Plug, sizes DE-DD

Plug



- For contact cavity arrangements, see page C-43.
- For pcb hole pattern, see Combo D Catalog.

75 Ohm\* coax inserted with straight contacts and standoff with UNC 4-40 thread

Shell size	Layout	75 OHM INDUSTRIAL		50 OHM MILITARY/HI-REL		NON-MAGNETIC/LOW OUTGASSING***
		P/N without Boardlock	P/N with Boardlock	P/N without Boardlock	P/N with UNC Boardlock	P/N with Gold Plating
DE	2W2	DEMV2C2P-NK87	DEM22C2P-NK87	DEMMV2X2P-N	DEMMZ2X2P-N	DEM22X2P-NNMBK52
DE	2WK2	DEMV2CK2P-NK87	DEM22CK2P-NK87	DEMMV2XK2P-N	DEMMZ2XK2P-N	DEM22XK2P-NNMBK52
DE	5W1	DEMV5C1P-NK87	DEM25C1P-NK87	DEMMV5X1P-N	DEMMZ5X12P-N	DEM25X1P-NNMBK52
DA	7W2	DAMV7C2P-NK87	DAM27C2P-NK87	DAMMV7X2P-N	DAMMZ7X2P-N	DAM27X2P-NNMBK52
DA	7W2	DAMV7C2P-NAK87	DAM27C2P-NAK87	DAMMV7X2P-N	DAMMZ7X2P-N	DAM27X2P-NNMBK52
DA	11W1	DAMV11C1P-NK87	DAM211C1P-NK87	DAMMV11X1P-N	DAMMZ11X1P-N	DAM211X1P-NNMBK52
DA	3W3	DAMV3C3P-NK87	DAM23C3P-NK87	DAMMV3X3P-N	DAMMZ3X3P-N	DAM23X3P-NNMBK52
DA	3WK3	DAMV3CK3P-NK87	DAM23CK3P-NK87	DAMMV3XK3P-N	DAMMZ3XK3P-N	DAM23XK3P-NNMBK52
DB	5W5	DBMV5C5P-NK87	DBM25C5P-NK87	DBMMV5X5P-N	DBMMZ5X5P-N	DBM25X5P-NNMBK52
DB	9W4	DBMV9C4P-NK87	DBM29C4P-NK87	DBMMV9X4P-N	DBMMZ9X4P-N	DBM29X4P-NNMBK52
DB	13W3	DBMV13C3P-NK87	DBM213C3P-NK87	DBMMV13X3P-N	DBMMZ13X3P-N	DBM213X3P-NNMBK52
DB	17W2	DBMV17C2P-NK87	DBM217C2P-NK87	DBMMV17X2P-N	DBMMZ17X2P-N	DBM217X2P-NNMBK52
DB	21W1	DBMV21C1P-NK87	DBM221C1P-NK87	DBMMV21X1P-N	DBMMZ21X1P-N	DBM221X1P-NNMBK52
DC	8W8	DCMV8C8P-NK87	DCM28C8P-NK87	DCMMV8X8P-N	DCMMZ8X8P-N	DCM28X8P-NNMBK52
DC	13W6	DCMV13C6P-NK87	DCM213C6P-NK87	DCMMV13X6P-N	DCMMZ13X6P-N	DCM213X6P-NNMBK52
DC	17W5	DCMV17C5P-NK87	DCM217C5P-NK87	DCMMV17X5P-N	DCMMZ17X5P-N	DCM217X5P-NNMBK52
DC	21WA4	DCMV21CA4P-NK87	DCM221CA4P-NK87	DCMMV21XA4P-N	DCMMZ21XA4P-N	DCM221XA4P-NNMBK52
DC	25W3	DCMV25C3P-NK87	DCM225C3P-NK87	DCMMV25X3P-N	DCMMZ25X3P-N	DCM225X3P-NNMBK52
DC	27W2	DCMV27C2P-NK87	DCM227C2P-NK87	DCMMV27X2P-N	DCMMZ27X2P-N	DCM227X2P-NNMBK52
DD	24W7	DDMV24C7P-NK87	DDM224C7P-NK87	DDMMV24X7P-N	DDMMZ24X7P-N	DDM224X7P-NNMBK52
DD	36W4	DDMV36C4P-NK87	DDM236C4P-NK87	DDMMV36X4P-N	DDMMZ36X4P-N	DDM236X4P-NNMBK52
DD	43W2	DDMV43C2P-NK87	DDM243C2P-NK87	DDMMV43X2P-N	DDMMZ43X2P-N	DDM243X2P-NNMBK52
DD	47W1	DDMV47C1P-NK87	DDM247C1P-NK87	DDMMV47X1P-N	DDMMZ47X1P-N	DDM247X1P-NNMBK52

\* For 50 ohm coaxial inserts replace C with X, e.g.:DDM243C2P-N becomes DDMZ43X2P-N. For M-3 and other hardware options, see Combo D Catalog.

\*\*\* Hardware Modifier not allowed with Non Magnetic/ Low Outgassing Combo-D- Contact factory for more information

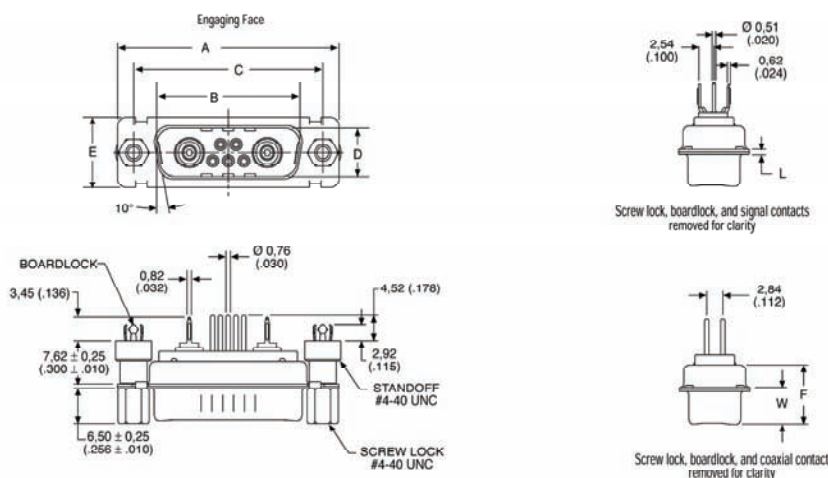

Dimensions

Shell size	A ± 0,38 (.015)	B ± 0,13 (.005)	C ± 0,13 (.005)	D ± 0,13 (.005)	E ± 0,38 (.015)	F ± 0,25 (.010)	W ± 0,368 (.0145)	W ± 0,41 (.016)	L ± 0,25 (.010)
DE	30,81 (1.213)	16,92 (.665)	24,99 (.984)	8,36 (.329)	12,55 (.494)	10,72 (.422)	6,693 (.2635)	—	0,76 (.030)
DA	39,14 (1.541)	25,25 (.994)	33,32 (1.312)	8,36 (.329)	12,55 (.494)	10,72 (.422)	6,693 (.2635)	—	0,76 (.030)
DB	53,04 (2.088)	38,96 (1.534)	47,04 (1.852)	8,36 (.329)	12,55 (.494)	10,82 (.426)	—	6,84 (.269)	0,99 (.039)
DC	69,32 (2.729)	55,42 (2.182)	63,50 (2.500)	8,36 (.329)	12,55 (.494)	10,82 (.426)	—	6,84 (.269)	0,99 (.039)
DD	66,93 (2.635)	52,81 (2.079)	61,11 (2.406)	11,07 (.436)	15,37 (.605)	10,82 (.426)	6,84 (.269)	0,99 (.039)	—

Dimensions shown in inches (mm)  
Specifications and dimensions subject to change

# Coax Straight PCB Receptacle DE-DD

## Coaxial Straight PCB Receptacle, sizes DE-DD

### Receptacle



- For contact cavity arrangements, see page C-43.
- For pcb hole pattern, see Combo D Catalog.

75 Ohm\* coax inserted with straight contacts and standoff with UNC 4-40 thread

Shell size	Layout	75 OHM INDUSTRIAL		50 OHM MILITARY/HI-REL		50 OHM NON-MAGNETIC/LOW OUTGASSING***
		P/N without Boardlock	P/N with Boardlock	P/N without Boardlock	P/N with UNC Boardlock	P/N with Gold Plating
DE	2W2	DEMV2C2S-NA197	DEMZ2C2S-NA197	DEMMV2X2S-N	DEMMZ2X2S-N	DEM2X2S-NNMBK52
DE	2WK2	DEMV2CK2S-NA197	DEMZ2CK2S-NA197	DEMMV2XK2S-N	DEMMZ2XK2S-N	DEM2XK2S-NNMBK52
DE	5W1	DEMV5C1S-NA197	DEMZ5C1S-NA197	DEMMV5X1S-N	DEMMZ5X1S-N	DEM5X1S-NNMBK52
DA	7W2	DAMV7C2S-NA197	DAMZ7C2S-NA197	DAMMV7X2S-N	DAMMZ7X2S-N	DAM7X2S-NNMBK52
DA	11W1	DAMV11C1S-NA197	DAMZ11C1S-NA197	DAMMV11X1S-N	DAMMZ11X1S-N	DAM11X1S-NNMBK52
DA	3W3	DAMV3C3S-NA197	DAMZ3C3S-NA197	DAMMV3X3S-N	DAMMZ3X3S-N	DAM3X3S-NNMBK52
DA	3WK3	DAMV3CK3S-NA197	DAMZ3CK3S-NA197	DAMMV3XK3S-N	DAMMZ3XK3S-N	DAM3XK3S-NNMBK52
DB	5W5	DBMV5C5S-NA197	DBMZ5C5S-NA197	DBMMV5X5S-N	DBMMZ5X5S-N	DBM5X5S-NNMBK52
DB	9W4	DBMV9C4S-NA197	DBMZ9C4S-NA197	DBMMV9X4S-N	DBMMZ9X4S-N	DBM9X4S-NNMBK52
DB	13W3	DBMV13C3S-NA197	DBMZ13C3S-NA197	DBMMV13X3S-N	DBMMZ13X3S-N	DBM13X3S-NNMBK52
DB	17W2	DBMV17C2S-NA197	DBMZ17C2S-NA197	DBMMV17X2S-N	DBMMZ17X2S-N	DBM17X2S-NNMBK52
DB	21W1	DBMV21C1S-NA197	DBMZ21C1S-NA197	DBMMV21X1S-N	DBMMZ21X1S-N	DBM21X1S-NNMBK52
DC	8W8	DCMV8C8S-NA197	DCMZ8C8S-NA197	DCMMV8X8S-N	DCMMZ8X8S-N	DCM8X8S-NNMBK52
DC	13W6	DCMV13C6S-NA197	DCMZ13C6S-NA197	DCMMV13X6S-N	DCMMZ13X6S-N	DCM13X6S-NNMBK52
DC	17W5	DCMV17C5S-NA197	DCMZ17C5S-NA197	DCMMV17X5S-N	DCMMZ17X5S-N	DCM17X5S-NNMBK52
DC	21WA4	DCMV21CA4S-NA197	DCMZ21CA4S-NA197	DCMMV21XA4S-N	DCMMZ21XA4S-N	DCM21XA4S-NNMBK52
DC	25W3	DCMV25C3S-NA197	DCMZ25C3S-NA197	DCMMV25X3S-N	DCMMZ25X3S-N	DCM25X3S-NNMBK52
DC	27W2	DCMV27C2S-NA197	DCMZ27C2S-NA197	DCMMV27X2S-N	DCMMZ27X2S-N	DCM27X2S-NNMBK52
DD	24W7	DDMV24C7S-NA197	DDMZ24C7S-NA197	DDMMV24X7S-N	DDMMZ24X7S-N	DDM24X7S-NNMBK52
DD	36W4	DDMV36C4S-NA197	DDMZ36C4S-NA197	DDMMV36X4S-N	DDMMZ36X4S-N	DDM36X4S-NNMBK52
DD	43W2	DDMV43C2S-NA197	DDMZ43C2S-NA197	DDMMV43X2S-N	DDMMZ43X2S-N	DDM43X2S-NNMBK52
DD	47W1	DDMV47C1S-NA197	DDMZ47C1S-NA197	DDMMV47X1S-N	DDMMZ47X1S-N	DDM47X1S-NNMBK52

\* For 50 ohm coaxial inserts replace C with X, e.g.:DDMZ43C2S-N becomes DDMZ43X2S-N.

\*\*For M-3 and other hardware options, see Combo D Catalog.

\*\*\* Hardware Modifier not allowed with Non Magnetic/ Low Outgassing Combo-D- Contact factory for more information

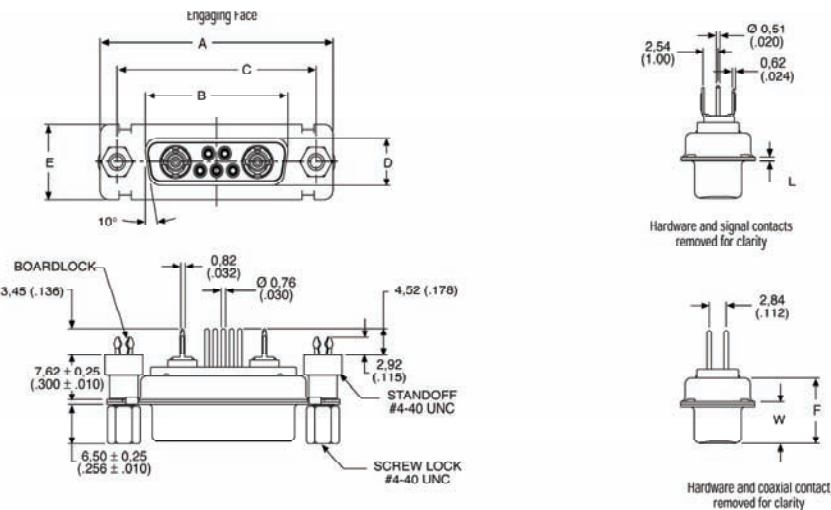

### Dimensions

Shell size	A	B	C	D	E	F	W	L
	± 0,38 (.015)	± 0,13 (.005)	± 0,13 (.005)	± 0,13 (.005)	± 0,38 (.015)	± 0,25 (.010)	± 0,38 (.015)	± 0,25 (.010)
DE	30,81 (1.213)	16,33 (.643)	24,99 (.984)	7,90 (.311)	12,55 (.494)	10,90 (.429)	6,94 (.273)	0,76 (.030)
DA	39,14 (1.541)	24,65 (.971)	33,32 (1.312)	7,90 (.311)	12,55 (.494)	10,90 (.429)	6,94 (.273)	0,76 (.030)
DB	53,04 (2.088)	38,38 (1.511)	47,04 (1.852)	7,90 (.311)	12,55 (.494)	10,90 (.429)	6,94 (.273)	0,76 (.030)
DC	69,32 (2.729)	54,84 (2.159)	63,50 (2.500)	7,90 (.311)	12,55 (.494)	10,90 (.429)	6,94 (.273)	0,76 (.030)
DD	66,93 (2.635)	52,42 (2.064)	61,11 (2.406)	10,74 (.423)	15,37 (.605)	10,90 (.429)	6,94 (.273)	0,76 (.030)



Dimensions shown in inches (mm)  
Specifications and dimensions subject to change

www.ittcannon.com

Plug, Crimp Cable Connectors without Contacts, Sizes DE-DD

Plug

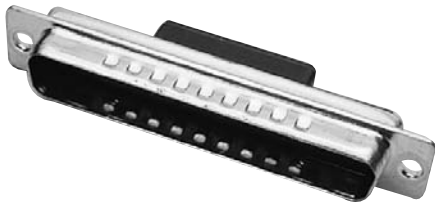

- For contact cavity arrangements, see page C-43
- For crimp contacts size 20, see page C-13.
- Size 8 contacts, please refer to Combo D catalog.

Shell size	Layout	INDUSTRIAL Part number	MILITARY/HI-REL Part number	NON-MAGNETIC/LOW OUTGASSING** Part number
DE	2W2	DEA2W2PK87FO	DEA2W2PFO	DEA2W2PNMBK47FO
DE	2WK2	DEA2WK2PK87FO	DEA2WK2PFO	DEA2WK2PNMBK47FO
DA	7W2	DAA7W2PK87FO	DAA7W2PFO	DAA7W2PNMBK47FO
DA	11W1	DAA11W1PK87FO	DAA11W1PFO	DAA11W1PNMBK47FO
DA	3W3	DAA3W3PK87FO	DAA3W3PFO	DAA3W3PNMBK47FO
DA	3WK3	DAA3WK3PK87FO	DAA3WK3PFO	DAA3WK3PNMBK47FO
DB	5W5	DBA5W5PK87FO	DBA5W5PFO	DBA5W5PNMBK47FO
DB	9W4	DBA9W4PK87FO	DBA9W4PFO	DBA9W4PNMBK47FO
DB	13W3	DBA13W3PK87FO	DBA13W3PFO	DBA13W3PNMBK47FO
DB	17W2	DBA17W2PK87FO	DBA17W2PFO	DBA17W2PNMBK47FO
DB	21W1	DBA21W1PK87FO	DBA21W1PFO	DBA21W1PNMBK47FO
DC	8W8	DCA8W8PK87FO	DCA8W8PFO	DCA8W8PNMBK47FO
DC	21WA4	DCA21WA4PK87FO	DCA21WA4PFO	DCA21WA4PNMBK47FO
DD	24W7	DDA24W7PK87FO	DDA24W7PFO	DDA24W7PNMBK47FO
DD	36W4	DDA36W4PK87FO	DDA36W4PFO	DDA36W4PNMBK47FO
DD	43W2	DDA43W2PK87FO	DDA43W2PFO	DDA43W2PNMBK47FO

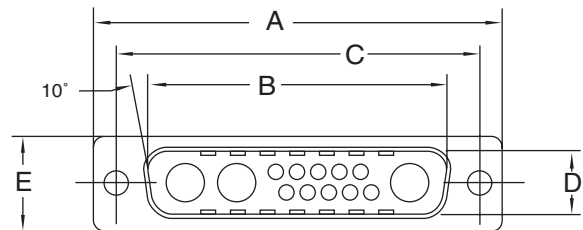
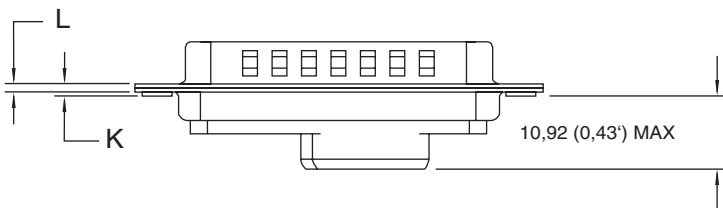

Dimensions

Shell size	A ± 0,38 (.015)	B ± 0,13 (.005)	C ± 0,13 (.005)	D ± 0,13 (.005)	E ± 0,38 (.015)	F ± 0,25 (.010)	W ± 0,368 (.0145)	W ± 0,41 (.016)	K ± 0,317 (.0125)	K ± 0,25 (.010)	L ± 0,25 (.010)
DE	30,81 (1.213)	16,92 (.666)	24,99 (.984)	8,36 (.329)	12,55 (.494)	10,72 (.422)	6,693 (.2635)	—	1,206 (.0475)	—	0,76 (.030)
DA	39,14 (1.541)	25,25 (.994)	33,32 (1.312)	8,36 (.329)	12,55 (.494)	10,72 (.422)	6,693 (.2635)	—	1,206 (.0475)	—	0,76 (.030)
DB	53,04 (2.088)	38,96 (1.534)	47,04 (1.852)	8,36 (.329)	12,55 (.494)	10,82 (.426)	—	6,84 (.269)	—	1,52 (.060)	0,99 (.039)
DC	69,32 (2.729)	55,42 (2.182)	63,50 (2.500)	8,36 (.329)	12,55 (.494)	10,82 (.426)	—	6,84 (.269)	—	1,52 (.060)	0,99 (.039)
DD	66,93 (2.635)	52,81 (2.079)	61,11 (2.406)	11,07 (.436)	15,37 (.605)	10,82 (.426)	—	6,84 (.269)	—	1,52 (.060)	0,99 (.039)

Dimensions shown in inches (mm)  
Specifications and dimensions subject to change

# Cannon Combo-D, Crimp Military/High Reliability

## Receptacle, Crimp Cable Connectors without Contacts, Sizes DE-DD

### Receptacle

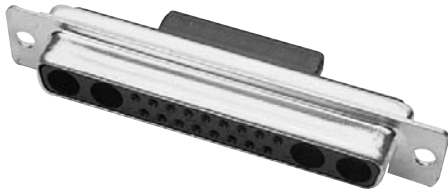

- For contact cavity arrangements, see page C-43.
- For crimp contacts size 20, see page C-13.
- Size 8 contacts, please refer to Combo D catalog.

Shell size	Layout	INDUSTRIAL Part number	MILITARY/HI-REL Part number	NON-MAGNETIC/LOW OUTGASSING** Part number
DE	2W2	DEA2W2SA197FO	DEA2W2SFO	DEA2W2SNMBK47FO
DE	2WK2	DEA2WK2SA197FO	DEA2WK2SFO	DEA2WK2SNMBK47FO
DA	7W2	DAA7W2SA197FO	DAA7W2SFO	DAA7W2SNMBK47FO
DA	11W1	DAA11W1SA197FO	DAA11W1SFO	DAA11W1SNMBK47FO
DA	3W3	DAA3W3SA197FO	DAA3W3SFO	DAA3W3SNMBK47FO
DA	3WK3	DAA3WK3SA197FO	DAA3WK3SFO	DAA3WK3SNMBK47FO
DB	5W5	DBA5W5SA197FO	DBA5W5SFO	DBA5W5SNMBK47FO
DB	9W4	DBA9W4SA197FO	DBA9W4SFO	DBA9W4SNMBK47FO
DB	13W3	DBA13W3SA197FO	DBA13W3SFO	DBA13W3SNMBK47FO
DB	17W2	DBA17W2SA197FO	DBA17W2SFO	DBA17W2SNMBK47FO
DB	21W1	DBA21W1SA197FO	DBA21W1SFO	DBA21W1SNMBK47FO
DC	8W8	DCA8W8SA197FO	DCA8W8SFO	DCA8W8SNMBK47FO
DC	21WA4	DCA21WA4SA197FO	DCA21WA4SFO	DCA21WA4SNMBK47FO
DD	24W7	DDA24W7SA197FO	DDA24W7SFO	DDA24W7SNMBK47FO
DD	36W4	DDA36W4SA197FO	DDA36W4SFO	DDA36W4SNMBK47FO
DD	43W2	DDA43W2SA197FO	DDA43W2SFO	DDA43W2SNMBK47FO

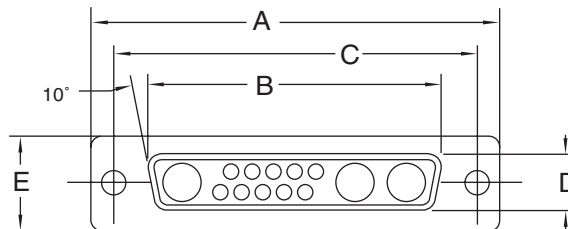
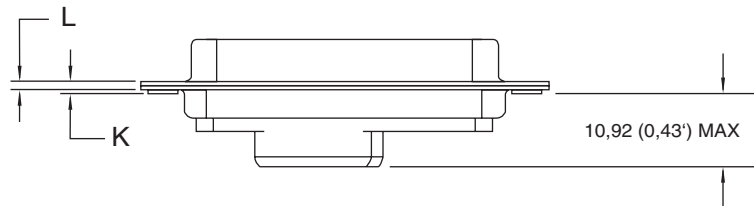

### Dimensions

Shell size	A	B	C	D	E	F	W	K	L
	± 0,38 (.015)	± 0,13 (.005)	± 0,13 (.005)	± 0,13 (.005)	± 0,38 (.015)	± 0,25 (.010)	± 0,38 (.015)	± 0,317 (.0125)	± 0,25 (.010)
DE	30,81 (1.213)	16,33 (.643)	24,99 (.984)	7,90 (.311)	12,55 (.494)	10,90 (.429)	6,94 (.273)	1,206 (.0475)	0,76 (.030)
DA	39,14 (1.541)	24,65 (.971)	33,32 (1.312)	7,90 (.311)	12,55 (.494)	10,90 (.429)	6,94 (.273)	1,206 (.0475)	0,76 (.030)
DB	53,04 (2.088)	38,38 (1.511)	47,04 (1.852)	7,90 (.311)	12,55 (.494)	10,90 (.429)	6,94 (.273)	1,206 (.0475)	0,76 (.030)
DC	69,32 (2.729)	54,84 (2.159)	63,50 (2.500)	7,90 (.311)	12,55 (.494)	10,90 (.429)	6,94 (.273)	1,206 (.0475)	0,76 (.030)
DD	66,93 (2.635)	52,42 (2.064)	61,11 (2.406)	10,74 (.423)	15,37 (.494)	10,90 (.429)	6,94 (.273)	1,206 (.0475)	0,76 (.030)



Dimensions shown in inches (mm)  
Specifications and dimensions subject to change

## 40 A High Power Straight PCB Plug, Sizes DE-DC

### Plug

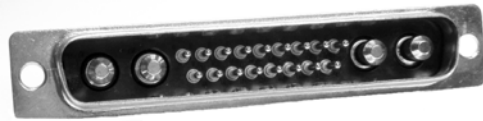

- For contact cavity arrangements, see page C-43.
- For pcb hole pattern, see Combo D Catalog.

### 40 A High power inserted with straight contacts and standoff with UNC 4-40 thread

Shell size	Layout	INDUSTRIAL		MILITARY/HI-REL		NON-MAGNETIC*/LOW OUTGASSING**	
		P/N without Boardlock	P/N with Boardlock	P/N without Boardlock	P/N with UNC Boardlock	P/N without Boardlock	P/N with Gold Plating
DE	2W2	DEM2H2PNK87	DEM2H2P-NK87	DEMMV2H2P-N	DEMMZ2H2P-N	DEM2H2P-NNMBK52	
DE	2WK2	DEM2HK2PNK87	DEM2HK2P-NK87	DEMMV2HK2P-N	DEMMZ2HK2P-N	DEM2HK2P-NNMBK52	
DE	5W1	DEM5H1PNK87	DEM5H1P-NK87	DEMMV5H1P-N	DEMMZ5H1P-N	DEM5H1P-NNMBK52	
DA	7W2	DAMV7H2PNK87	DAMZ7H2P-NK87	DAMMV7H2P-N	DAMMZ7H2P-N	DAMZ7H2P-NNMBK52	
DA	11W1	DAMV11H1PNK87	DAMZ11H1P-NK87	DAMMV11H1P-N	DAMMZ11H1P-N	DAMZ11H1P-NNMBK52	
DA	3W3	DAMV3H3PNK87	DAMZ3H3P-NK87	DAMMV3H3P-N	DAMMZ3H3P-N	DAMZ3H3P-NNMBK52	
DA	3WK3	DAMV3HK3PNK87	DAMZ3HK3P-NK87	DAMMV3HK3P-N	DAMMZ3HK3P-N	DAMZ3HK3P-NNMBK52	
DB	5W5	DBMV5H5PNK87	DBMZ5H5P-NK87	DBMMV5H5P-N	DBMMZ5H5P-N	DBMZ5H5P-NNMBK52	
DB	9W4	DBMV9H4PNK87	DBMZ9H4P-NK87	DBMMV9H4P-N	DBMMZ9H4P-N	DBMZ9H4P-NNMBK52	
DB	13W3	DBMV13H3PNK87	DBMZ13H3P-NK87	DBMMV13H3P-N	DBMMZ13H3P-N	DBMZ13H3P-NNMBK52	
DB	17W2	DBMV17H2PNK87	DBMZ17H2P-NK87	DBMMV17H2P-N	DBMMZ17H2P-N	DBMZ17H2P-NNMBK52	
DB	21W1	DBMV21H1PNK87	DBMZ21H1P-NK87	DBMMV21H1P-N	DBMMZ21H1P-N	DBMZ21H1P-NNMBK52	
DC	8W8	DCMV8H8PNK87	DCMZ8H8P-NK87	DCMMV8H8P-N	DCMMZ8H8P-N	DCMZ8H8P-NNMBK52	
DC	13W6	DCMV13H6PNK87	DCMZ13H6P-NK87	DCMMV13H6P-N	DCMMZ13H6P-N	DCMZ13H6P-NNMBK52	
DC	17W5	DCMV17H5PNK87	DCMZ17H5P-NK87	DCMMV17H5P-N	DCMMZ17H5P-N	DCMZ17H5P-NNMBK52	
DC	21WA4	DCMV21HA4PNK87	DCMZ21HA4P-NK87	DCMMV21HA4P-N	DCMMZ21HA4P-N	DCMZ21HA4P-NNMBK52	
DC	25W3	DCMV25H3PNK87	DCMZ25H3P-NK87	DCMMV25H3P-N	DCMMZ25H3P-N	DCMZ25H3P-NNMBK52	
DC	27W2	DCMV27H2PNK87	DCMZ27H2P-NK87	DCMMV27H2P-N	DCMMZ27H2P-N	DCMZ27H2P-NNMBK52	

\*\*Hardware Modifier not allowed on Non-Magnetic/Low Outgassing Versions; consult factory for more information

\*\*For other hardware options, see Combo D Catalog.

### 40 A High power straight inserted with straight contacts and standoff with 4-40 thread

Shell size	Layout	P/N Industrial	P/N Military	P/N Base**
DD	24W7	DDM24H7P-NK87	DDMM24H7P-N	DDM24H7P-NNMBK52
DD	36W4	DDM36H4P-NK87	DDMM36H4P-N	DDM36H4P-NNMBK52
DD	43W2	DDM43H2P-NK87	DDMM43H2P-N	DDM43H2P-NNMBK52
DD	47W1	DDM47H1P-NK87	DDMM47H1P-N	DDM47H1P-NNMBK52

\*For M-3 hardware and other hardware options, see Combo D Catalog. \*\*\* Hardware Modifier not allowed on Non-Magnetic/Low Outgassing Versions; consult factory for more information

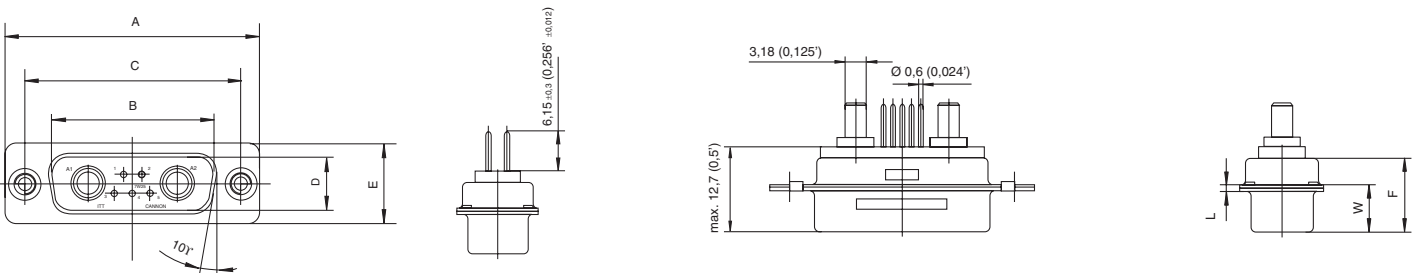

### Dimensions

Shell size	A	B	C	D	E	F	W	W	L
	± 0,38 (.015)	± 0,13 (.005)	± 0,13 (.005)	± 0,13 (.005)	± 0,38 (.015)	± 0,25 (.010)	± 0,368 (.0145)	± 0,41 (.016)	± 0,25 (.010)
DE	30,81 (1.213)	16,92 (.665)	24,99 (.984)	8,36 (.329)	12,55 (.494)	10,72 (.422)	6,693 (.2635)	—	0,76 (.030)
DA	39,14 (1.541)	25,25 (.994)	33,32 (1.312)	8,36 (.329)	12,55 (.494)	10,72 (.422)	6,693 (.2635)	—	0,76 (.030)
DB	53,04 (2.088)	38,96 (1.534)	47,04 (1.852)	8,36 (.329)	12,55 (.494)	10,82 (.426)	—	6,84 (.269)	0,99 (.039)
DC	69,32 (2.729)	55,42 (2.182)	63,50 (2.500)	8,36 (.329)	12,55 (.494)	10,82 (.426)	—	6,84 (.269)	0,99 (.039)
DD	66,93 (2.635)	52,81 (2.079)	61,11 (2.406)	11,07 (.436)	15,37 (.605)	10,82 (.426)	—	6,84 (.264)	0,99 (.039)

Dimensions shown in inches (mm)  
Specifications and dimensions subject to change

# Cannon Combo-D Military/High Reliability

## 40 A High Power Straight PCB Receptacle, Sizes DE-DC

Receptacle

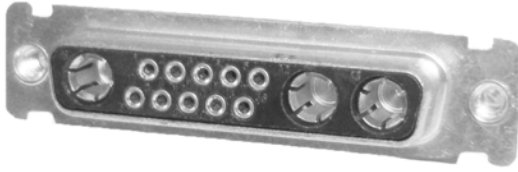

- For contact cavity arrangements, see page C-43.
- For pcb hole pattern, see Combo D Catalog.

### 40 A High power inserted with straight contacts and standoff with UNC 4-40 thread

Shell size	Layout	INDUSTRIAL		MILITARY/HI-REL		NON-MAGNETIC**/LOW OUTGASSING***	
		P/N without pushfit	P/N with pushfit	P/N without pushfit	P/N with pushfit	P/N with Cadmium Plating	P/N with Gold Plating
DE	2W2	DEM2H2SNA197	DEM2H2S-NA197	DEMMV2H2S-N	DEMMZ2H2S-N	DEM2H2S-NNMB	DEM2H2S-NNMBK52
DE	2WK2	DEM2HK2SNA197	DEM2HK2S-NA197	DEMMV2HK2S-N	DEMMZ2HK2S-N	DEM2HK2S-NNMB	DEM2HK2S-NNMBK52
DE	5W1	DEM5H1SNA197	DEM5H1S-NA197	DEMMV5H1S-N	DEMMZ2HK2S-N	DEM5H1S-NNMB	DEM5H1S-NNMBK52
DA	7W2	DAMV7H2SNA197	DAMZ7H2S-NA197	DAMMV7H2S-N	DAMMZ7H2S-N	DAM7H2S-NNMB	DAM7H2S-NNMBK52
DA	11W1	DAMV11H1SNA197	DAMZ11H1S-NA197	DAMMV11H1S-N	DAMMZ11H1S-N	DAM11H1S-NNMB	DAM11H1S-NNMBK52
DA	3W3	DAMV3H3SNA197	DAMZ3H3S-NA197	DAMMV3H3S-N	DAMMZ3H3S-N	DAM3H3S-NNMB	DAM3H3S-NNMBK52
DA	3WK3	DAMV3HK3SNA197	DAMZ3HK3S-NA197	DAMMV3HK3S-N	DAMMZ3HK3S-N	DAM3HK3S-NNMB	DAM3HK3S-NNMBK52
DB	5W5	DBMV5H5SNA197	DBMZ5H5S-NA197	DBMMV5H5S-N	DBMMZ5H5S-N	DBM5H5S-NNMB	DBM5H5S-NNMBK52
DB	9W4	DBMV9H4SNA197	DBMZ9H4S-NA197	DBMMV9H4S-N	DBMMZ9H4S-N	DBM9H4S-NNMB	DBM9H4S-NNMBK52
DB	13W3	DBMV13H3SNA197	DBMZ13H3S-NA197	DBMMV13H3S-N	DBMMZ13H3S-N	DBM13H3S-NNMB	DBM13H3S-NNMBK52
DB	17W2	DBMV17H2SNA197	DBMZ17H2S-NA197	DBMMV17H2S-N	DBMMZ17H2S-N	DBM17H2S-NNMB	DBM17H2S-NNMBK52
DB	21W1	DBMV21H1SNA197	DBMZ21H1S-NA197	DBMMV21H1S-N	DBMMZ21H1S-N	DBM21H1S-NNMB	DBM21H1S-NNMBK52
DC	8W8	DCMV8H8SNA197	DCMZ8H8S-NA197	DCMMV8H8S-N	DCMMZ8H8S-N	DCM8H8S-NNMB	DCM8H8S-NNMBK52
DC	13W6	DCMV13H6SNA197	DCMZ13H6S-NA197	DCMMV13H6S-N	DCMMZ13H6S-N	DCM13H6S-NNMB	DCM13H6S-NNMBK52
DC	17W5	DCMV17H5SNA197	DCMZ17H5S-NA197	DCMMV17H5S-N	DCMMZ17H5S-N	DCM17H5S-NNMB	DCM17H5S-NNMBK52
DC	21WA4	DCMV21HA4SNA197	DCMZ21HA4S-NA197	DCMMV21HA4S-N	DCMMZ21HA4S-N	DCM21HA4S-NNMB	DCM21HA4S-NNMBK52
DC	25W3	DCMV25H3SNA197	DCMZ25H3S-NA197	DCMMV25H3S-N	DCMMZ25H3S-N	DCM25H3S-NNMB	DCM25H3S-NNMBK52
DC	27W2	DCMV27H2SNA197	DCMZ27H2S-NA197	DCMMV27H2S-N	DCMMZ27H2S-N	DCM27H2S-NNMB	DCM27H2S-NNMBK52

### 40 A High power straight inserted with straight contacts and standoff with 4-40 thread

Shell size	Layout	P/N Industrial	P/N Military	P/N Base*
DD	24W7	DDM24H7S-NA197	DDMM24H7S-N	DDM24H7S-NNMBK52
DD	36W4	DDM36H4S-NA197	DDMM36H4S-N	DDM36H4S-NNMBK52
DD	43W2	DDM43H2S-NA197	DDMM43H2S-N	DDM43H2S-NNMBK52
DD	47W1	DDM47H1S-NA197	DDMM47H1S-N	DDM47H1S-NNMBK52

\*For other hardware options, see Combo D Catalog.

\*\*\* Hardware Modifier not allowed on Non-Magnetic/ Low Outgassing Versions; consult factory for more information.

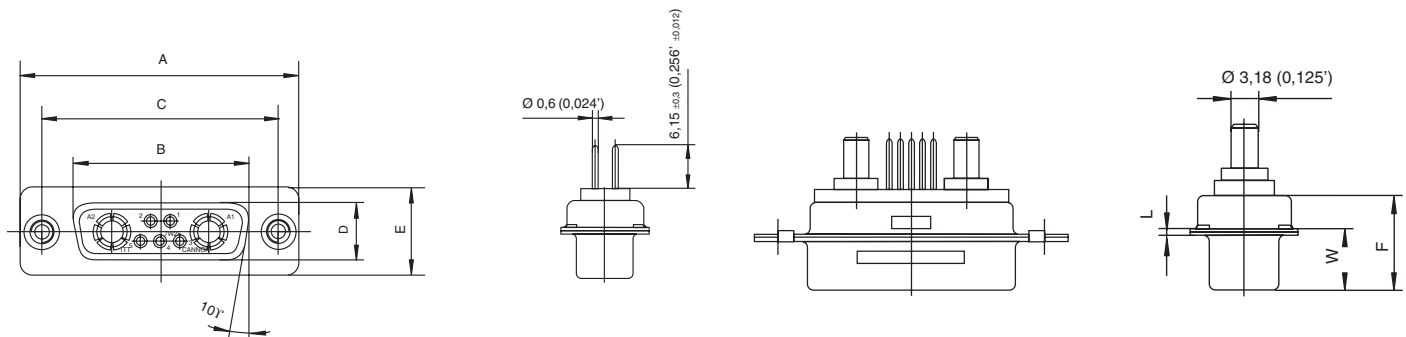

### Dimensions

Shell size	A ± 0,38 (.015)	B ± 0,13 (.005)	C ± 0,13 (.005)	D ± 0,13 (.005)	E ± 0,38 (.015)	F ± 0,25 (.010)	W ± 0,38 (.015)	L ± 0,25 (.010)
DE	30,81 (1.213)	16,33 (.643)	24,99 (.984)	7,90 (.311)	12,55 (.494)	10,90 (.429)	6,94 (.273)	0,76 (.030)
DA	39,14 (1.541)	24,65 (.971)	33,32 (1.312)	7,90 (.311)	12,55 (.494)	10,90 (.429)	6,94 (.273)	0,76 (.030)
DB	53,04 (2.088)	38,38 (1.511)	47,04 (1.852)	7,90 (.311)	12,55 (.494)	10,90 (.429)	6,94 (.273)	0,76 (.030)
DC	69,32 (2.729)	54,84 (2.159)	63,50 (2.500)	7,90 (.311)	12,55 (.494)	10,90 (.429)	6,94 (.273)	0,76 (.030)
DD	66,93 (2.635)	52,42 (2.406)	61,11 (2.406)	10,74 (.423)	15,37 (.605)	10,90 (.429)	6,94 (.273)	0,76 (.030)

\*For other hardware options, see Combo D Catalog.

\*\*\*Hardware Modifier not allowed on Non-Magnetic/Low Outgassing Versions; consult factory for more information.



Dimensions shown in inches (mm)  
Specifications and dimensions subject to change

www.ittcannon.com

## Coaxial 90° PCB Plug, sizes DE-DC, with metal bracket

### Plug



- For contact cavity arrangements, see page C-43.
- For pcb hole pattern, see Combo D Catalog.

Shell size	Layout	INDUSTRIAL – US 75 Ohm* coax inserted with US footprint metal bracket and UNC 4-40 captive nut		INDUSTRIAL – EU** 75 Ohm* coax inserted with EU footprint metal bracket and UNC 4-40 captive nut		MILITARY/HI-REL – US 50 Ohm* coax inserted with US footprint metal bracket and UNC 4-40 screw lock		NON-MAGNETIC- LOW OUTGASSING – US*** 50 Ohm* coax inserted with US footprint metal bracket and UNC 4-40 screw lock	
		P/N without Boardlock	P/N with Boardlock	P/N without Boardlock	P/N with Boardlock	P/N without Boardlock	P/N with Boardlock	P/N without Boardlock	P/N with Gold Plating
DE	2W2	DEMP2C2P-JK87	DEMC2C2P-JK87	DEMP2C2P-VK87	DEMC2C2P-VK87	DEMMD2X2P-J	DEMMG2X2P-J	DEM2X2P-JNMBK52	
DE	2WK2	DEMP2CK2P-JK87	DEMC2CK2P-JK87	DEMP2CK2P-VK87	DEMC2CK2P-VK87	DEMMD2XK2P-J	DEMMG2XK2P-J	DEM2XK2P-JNMBK52	
DE	5W1	DEMP5C1P-JK87	DEMC5C1P-JK87	DEMP5C1P-VK87	DEMC5C1P-VK87	DEMMD5X1P-J	DEMMG5X1P-J	DEM5X1P-JNMBK52	
DA	7W2	DAMP7C2P-JK87	DAMC7C2P-JK87	DAMP7C2P-VK87	DAMC7C2P-VK87	DAMMD7X2P-J	DAMMG7X2P-J	DAM7X2P-JNMBK52	
DA	11W1	DAMP11C1P-JK87	DAMC11C1P-JK87	DAMP11C1P-VK87	DAMC11C1P-VK87	DAMMD11X1P-J	DAMMG11X1P-J	DAM11X1P-JNMBK52	
DA	3W3	DAMP3C3P-JK87	DAMC3C3P-JK87	DAMP3C3P-VK87	DAMC3C3P-VK87	DAMMD3X3P-J	DAMMG3X3P-J	DAM3X3P-JNMBK52	
DA	3WK3	DAMP3CK3P-JK87	DAMC3CK3P-JK87	DAMP3CK3P-VK87	DAMC3CK3P-VK87	DAMMD3XK3P-J	DAMMG3XK3P-J	DAM3XK3P-JNMBK52	
DB	5W5	DBMP5C5P-JK87	DBMC5C5P-JK87	DBMP5C5P-VK87	DBMC5C5P-VK87	DBMMD5X5P-J	DBMMG5X5P-J	DBM5X5P-JNMBK52	
DB	9W4	DBMP9C4P-JK87	DBMC9C4P-JK87	DBMP9C4P-VK87	DBMC9C4P-VK87	DBMMD9X4P-J	DBMMG9X4P-J	DBM9X4P-JNMBK52	
DB	13W3	DBMP13C3P-JK87	DBMC13C3P-JK87	DBMP13C3P-VK87	DBMC13C3P-VK87	DBMMD13X3P-J	DBMMG13X3P-J	DBM13X3P-JNMBK52	
DB	17W2	DBMP17C2P-JK87	DBMC17C2P-JK87	DBMP17C2P-VK87	DBMC17C2P-VK87	DBMMD17X2P-J	DBMMG17X2P-J	DBM17X2P-JNMBK52	
DB	21W1	DBMP21C1P-JK87	DBMC21C1P-JK87	DBMP21C1P-VK87	DBMC21C1P-VK87	DBMMD21X1P-J	DBMMG21X1P-J	DBM21X1P-JNMBK52	
DC	8W8	DCMP8C8P-JK87	DCMC8C8P-JK87	DCMP8C8P-VK87	DCMC8C8P-VK87	DCMMD8X8P-J	DCMMG8X8P-J	DCM8X8P-JNMBK52	
DC	13W6	DCMP13C6P-JK87	DCMC13C6P-JK87	DCMP13C6P-VK87	DCMC13C6P-VK87	DCMMD13X6P-J	DCMMG13X6P-J	DCM13X6P-JNMBK52	
DC	17W5	DCMP17C5P-JK87	DCMC17C5P-JK87	DCMP17C5P-VK87	DCMC17C5P-VK87	DCMMD17X5P-J	DCMMG17X5P-J	DCM17X5P-JNMBK52	
DC	21WA4	DCMP21CA4P-JK87	DCMC21CA4P-JK87	DCMP21CA4P-VK87	DCMC21CA4P-VK87	DCMMD21XA4P-J	DCMMG21XA4P-J	DCM21XA4P-JNMBK52	
DC	25W3	DCMP25C3P-JK87	DCMC25C3P-JK87	DCMP25C3P-VK87	DCMC25C3P-VK87	DCMMD25X3P-J	DCMMG25X3P-J	DCM25X3P-JNMBK52	
DC	27W2	DCMP27C2P-JK87	DCMC27C2P-JK87	DCMP27C2P-VK87	DCMC27C2P-VK87	DCMMD27X2P-J	DCMMG27X2P-J	DCM27X2P-JNMBK52	

\* For 50 ohm coaxial inserts replace C with X, e.g.:DCM13C6P-J becomes DCM13X6P-J.    \*\*For M-3 hardware, see Combo D Catalog.

\*\*\* Hardware Modifier not allowed with Non Magnetic/ Low Outgassing Combo-D- Contact factory for more information

For 50 ohm coaxial version, see Combo D Catalog.

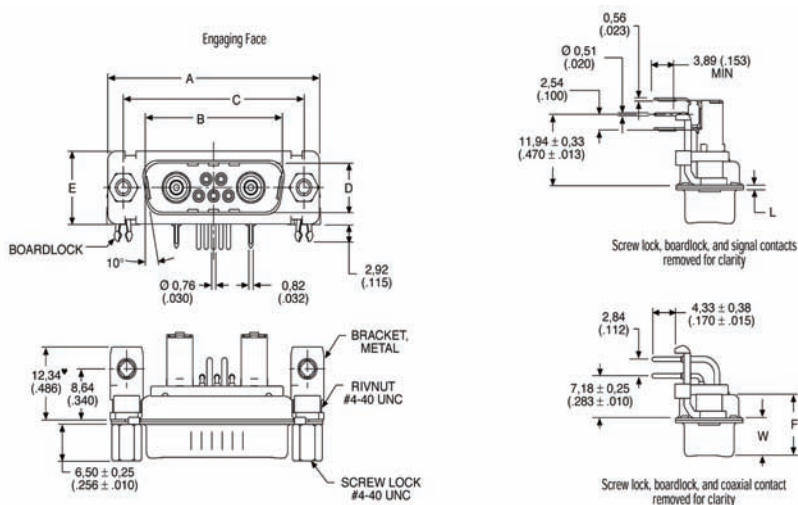

### Dimensions

Shell size	A ± 0,38 (.015)	B ± 0,13 (.005)	C ± 0,13 (.005)	D ± 0,13 (.005)	E ± 0,38 (.015)	F ± 0,25 (.010)	W ± 0,368 (.0145)	W ± 0,41 (.016)	L ± 0,25 (.010)
DE	30,81 (1.213)	16,92 (.665)	24,99 (.984)	8,36 (.329)	12,55 (.494)	10,72 (.422)	6,693 (.2635)	—	0,76 (.030)
DA	39,14 (1.541)	25,25 (.994)	33,32 (1.312)	8,36 (.329)	12,55 (.494)	10,72 (.422)	6,693 (.2635)	—	0,76 (.030)
DB	53,04 (2.088)	38,96 (1.534)	47,04 (1.852)	8,36 (.329)	12,55 (.494)	10,82 (.426)	—	6,84 (.269)	0,99 (.039)
DC	69,32 (2.729)	55,42 (2.182)	63,50 (2,500)	8,36 (.329)	12,55 (.494)	10,82 (.426)	—	6,84 (.269)	0,99 (.039)

Dimensions shown in inches (mm)  
Specifications and dimensions subject to change



# Cannon Combo D® Coax 90° PCB Plug DD Military/High Reliability

## Coaxial 90° PCB Plug, sizes DD, with metal bracket

### Plug



- For contact cavity arrangements, see page C-43.
- For pcb hole pattern, see Combo D Catalog.

Shell size	Layout	INDUSTRIAL – US 75 Ohm* coax inserted with US footprint metal bracket and UNC 4-40 captive nut		INDUSTRIAL – EU** 75 Ohm* coax inserted with EU footprint metal bracket and UNC 4-40 captive nut		MILITARY/HI-REL – US 50 Ohm* coax inserted with US footprint metal bracket and UNC 4-40 screw lock		NON-MAGNETIC/LOW OUTGASSING-EU*** 50 Ohm* coax inserted with US footprint metal bracket and UNC 4-40 screw lock	
		P/N without Boardlock	P/N with Boardlock	P/N without Boardlock	P/N with Boardlock	P/N without Boardlock	P/N with Boardlock	P/N with Gold Plating	
DD	24W7	DDMP24C7P-JK87	DDMC24C7P-JK87	DDMP24C7P-VK87	DDMC24C7P-VK87	DDMMD24X7P-J	DDMMG24X7P-J	DDM24X7P-JNMBK52	
DD	36W4	DDMP36C4P-JK87	DDMC36C4P-JK87	DDMP36C4P-VK87	DDMC36C4P-VK87	DDMMD36X4P-J	DDMMG36X4P-J	DDM36X4P-JNMBK52	
DD	43W2	DDMP43C2P-JK87	DDMC43C2P-JK87	DDMP43C2P-VK87	DDMC43C2P-VK87	DDMMD43X2P-J	DDMMG43X2P-J	DDM43X2P-JNMBK52	
DD	47W1	DDMP47C1P-JK87	DDMC47C1P-JK87	DDMP47C1P-VK87	DDMC47C1P-VK87	DDMMD47X1P-J	DDMMG47X1P-J	DDM47X1P-JNMBK52	

\* For 50 ohm coaxial inserts replace C with X, e.g.:DCM13C6P-J becomes DCM13X6P-J. \*\*For M-3 hardware, see Combo D Catalog.

\*\*\* Hardware Modifier not allowed with Non Magnetic/ Low Outgassing Combo-D- Contact factory for more information

0.888.0

C

D Sub

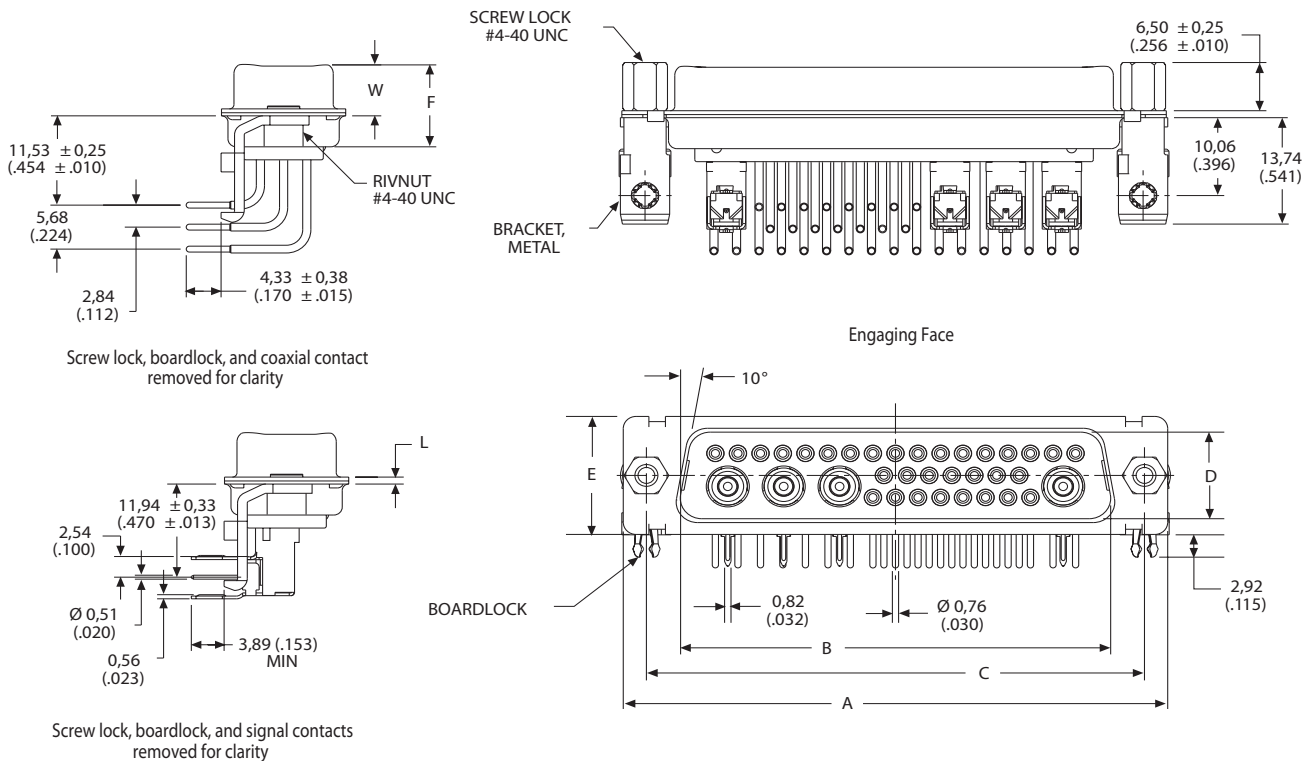

US version shown – for EU version, please contact factory.

For 50 ohm coaxial version, see Combo D Catalog

Note: Dimension varies with alternate bracket configuration, see Combo D Catalog.

### Dimensions

Shell size	A	B	C	D	E	F	W	L
DD	± 0,38 (.015)	± 0,13 (.005)	± 0,13 (.005)	± 0,13 (.005)	± 0,38 (.015)	± 0,25 (.010)	± 0,41 (.015)	± 0,25 (.010)
DD	66,93 (2.635)	52,81 (2.079)	61,11 (2.406)	11,07 (.436)	15,37 (.605)	10,82 (.426)	6,84 (.269)	0,99 (.039)



Dimensions shown in inches (mm)  
Specifications and dimensions subject to change

www.ittcannon.com

# Cannon Combo D® Coax 90° PCB Receptacle DE-DC Military/High Reliability

## Coaxial 90° PCB Receptacle, Sizes DE-DC, with metal bracket

### Receptacle



- For contact cavity arrangements, see page C-43.
- For pcb hole pattern, see Combo D Catalog.

**INDUSTRIAL – US**  
75 Ohm\* coax inserted with US Footprint metal bracket and UNC 4-40 captive nut

**INDUSTRIAL – EU\*\***  
75 Ohm\* coax inserted with EU Footprint metal bracket and UNC 4-40 captive nut

**MILITARY/HI-REL – US**  
50 Ohm\* coax inserted with US Footprint metal bracket and UNC 4-40 screw lock

**NON-MAGNETIC/LOW OUTGASSING – US\*\*\***  
50 Ohm\* coax inserted with US Footprint metal bracket and UNC 4-40 screw lock

Shell size	Layout	P/N without Boardlock	P/N with Boardlock	P/N without Boardlock	P/N with Boardlock	P/N without Boardlock	P/N with Boardlock	P/N with Gold Plating
DE	2W2	DEMP2C2S-JA197	DEMC2C2S-JA197	DEMP2C2S-VA197	DEMC2C2S-VA197	DEMMP2X2S-J	DEMCC2X2S-J	DEM2X2S-JNMBK52
DE	2WK2	DEMP2CK2S-JA197	DEMC2CK2S-JA197	DEMP2CK2S-VA197	DEMC2CK2S-VA197	DEMMP2XK2S-J	DEMCC2XK2S-J	DEM2XK2S-JNMBK52
DE	5W1	DEMP5C1S-JA197	DEMC5C1S-JA197	DEMP5C1S-VA197	DEMC5C1S-VA197	DEMMP5X1S-J	DEMCC5X1S-J	DEM5X1S-JNMBK52
DA	7W2	DAMP7C2S-JA197	DAMC7C2S-JA197	DAMP7C2S-VA197	DAMC7C2S-VA197	DAMMP7X2S-J	DAMMC7X2S-J	DAM7X2S-JNMBK52
DA	11W1	DAMP11C1S-JA197	DAMC11C1S-JA197	DAMP11C1S-VA197	DAMC11C1S-VA197	DAMMP11X1S-J	DAMMC11X1S-J	DAM11X1S-JNMBK52
DA	3W3	DAMP3C3S-JA197	DAMC3C3S-JA197	DAMP3C3S-VA197	DAMC3C3S-VA197	DAMMP3X3S-J	DAMMC3X3S-J	DAM3X3S-JNMBK52
DA	3WK3	DAMP3CK3S-JA197	DAMC3CK3S-JA197	DAMP3CK3S-VA197	DAMC3CK3S-VA197	DAMMP3XK3S-J	DAMMC3XK3S-J	DAM3XK3S-JNMBK52
DB	5W5	DBMP5C5S-JA197	DBMC5C5S-JA197	DBMP5C5S-VA197	DBMC5C5S-VA197	DBMMP5X5S-J	DBMMC5X5S-J	DBM5X5S-JNMBK52
DB	9W4	DBMP9C4S-JA197	DBMC9C4S-JA197	DBMP9C4S-VA197	DBMC9C4S-VA197	DBMMP9X4S-J	DBMMC9X4S-J	DBM9X4S-JNMBK52
DB	13W3	DBMP13C3S-JA197	DBMC13C3S-JA197	DBMP13C3S-VA197	DBMC13C3S-VA197	DBMMP13X3S-J	DBMMC13X3S-J	DBM13X3S-JNMBK52
DB	17W2	DBMP17C2S-JA197	DBMC17C2S-JA197	DBMP17C2S-VA197	DBMC17C2S-VA197	DBMMP17X2S-J	DBMMC17X2S-J	DBM17X2S-JNMBK52
DB	21W1	DBMP21C1S-JA197	DBMC21C1S-JA197	DBMP21C1S-VA197	DBMC21C1S-VA197	DBMMP21X1S-J	DBMMC21X1S-J	DBM21X1S-JNMBK52
DC	8W8	DCMP8C8S-JA197	DCMC8C8S-JA197	DCMP8C8S-VA197	DCMC8C8S-VA197	DCMMP8X8S-J	DCMMC8X8S-J	DCM8X8S-JNMBK52
DC	13W6	DCMP13C6S-JA197	DCMC13C6S-JA197	DCMP13C6S-VA197	DCMC13C6S-VA197	DCMMP13X6S-J	DCMMC13X6S-J	DCM13X6S-JNMBK52
DC	17W5	DCMP17C5S-JA197	DCMC17C5S-JA197	DCMP17C5S-VA197	DCMC17C5S-VA197	DCMMP17X5S-J	DCMMC17X5S-J	DCM17X5S-JNMBK52
DC	21WA4	DCMP21CA4S-JA197	DCMC21CA4S-JA197	DCMP21CA4S-VA197	DCMC21CA4S-VA197	DCMMP21XA4S-J	DCMMC21XA4S-J	DCM21XA4S-JNMBK52
DC	25W3	DCMP25C3S-JA197	DCMC25C3S-JA197	DCMP25C3S-VA197	DCMC25C3S-VA197	DCMMP25X3S-J	DCMMC25X3S-J	DCM25X3S-JNMBK52
DC	27W2	DCMP27C2S-JA197	DCMC27C2S-JA197	DCMP27C2S-VA197	DCMC27C2S-VA197	DCMMP27X2S-J	DCMMC27X2S-J	DCM27X2S-JNMBK52

\* For 50 ohm coaxial inserts replace C with X, e.g.:DCM13C6S-J becomes DCM13X6S-J. \*\*For M-3 and other hardware options, see Combo D Catalog.

\*\*\* Hardware Modifier not allowed with Non Magnetic/ Low Outgassing Combo-D- Contact factory for more information

US version shown, for EU version please see Combo D Catalog.  
For 50 ohm coaxial version, see Combo D Catalog.

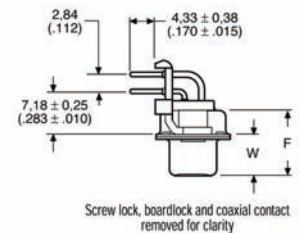
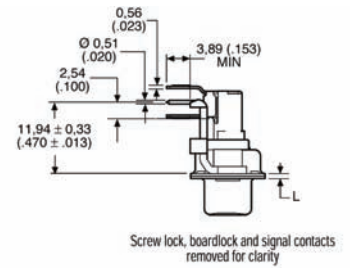
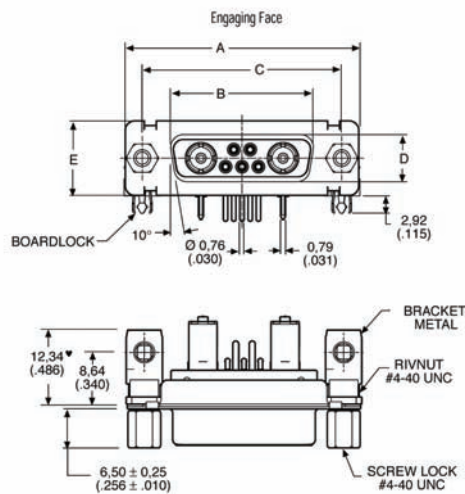

### Dimensions

Shell size	A ± 0,38 (.015)	B ± 0,13 (.005)	C ± 0,13 (.005)	D ± 0,13 (.005)	E ± 0,38 (.015)	F ± 0,25 (.010)	W ± 0,38 (.015)	L ± 0,25 (.010)
DE	30,81 (1.213)	16,33 (.643)	24,99 (.984)	7,90 (.311)	12,55 (.494)	10,90 (.429)	6,94 (.273)	0,76 (.030)
DA	39,14 (1.541)	24,65 (.971)	33,32 (1.312)	7,90 (.311)	12,55 (.494)	10,90 (.429)	6,94 (.273)	0,76 (.030)
DB	53,04 (2.088)	38,38 (1.511)	47,04 (1.852)	7,90 (.311)	12,55 (.494)	10,90 (.429)	6,94 (.273)	0,76 (.030)
DC	69,32 (2.729)	54,84 (2.159)	63,50 (2.500)	7,90 (.311)	12,55 (.494)	10,90 (.429)	6,94 (.273)	0,76 (.030)

Dimensions shown in inches (mm)  
Specifications and dimensions subject to change

www.itcannon.com

# Cannon Combo D® Coax 90° PCB Receptacle DD Military/High Reliability

## Coaxial 90° PCB Receptacle, Size DD, with metal bracket

### Receptacle



- For contact cavity arrangements, see page C-43.
- For pcb hole pattern, see Combo D Catalog..

**INDUSTRIAL – US**  
75 Ohm\* coax inserted with  
US Footprint metal bracket  
and UNC 4-40 captive nut

**INDUSTRIAL – EU\*\***  
75 Ohm\* coax inserted with  
EU Footprint metal bracket  
and UNC 4-40 captive nut

**MILITARY/HI-REL – US**  
75 Ohm\* coax inserted with  
US Footprint metal bracket  
and UNC 4-40 screw lock

**NON-MAGNETIC/LOW OUTGASSING – US\*\*\***  
75 Ohm\* coax inserted with  
US Footprint metal bracket  
and UNC 4-40 screw lock

Shell size	Layout	P/N without Boardlock	P/N with Boardlock	P/N without Boardlock	P/N with Boardlock	P/N without Boardlock	P/N with Boardlock	P/N with Gold Plating
DD	24W7	DDMP24C7S-JA197	DDMC24C7S-JA197	DDMP24C7S-VA197	DDMC24C7S-VA197	DDMMD24X7S-J	DDMMG24X2S-J	DDM24X7S-JNMBK52
DD	36W4	DDMP36C4S-JA197	DDMC36C4S-JA197	DDMP36C4S-VA197	DDMC36C4S-VA197	DDMMD36X4S-J	DDMMG36X1S-J	DDM36X4S-JNMBK52
DD	43W2	DDMP43C2S-JA197	DDMC43C2S-JA197	DDMP43C2S-VA197	DDMC43C2S-VA197	DDMMD43X2S-J	DDMMG43X2S-J	DDM43X2S-JNMBK52
DD	47W1	DDMP47C1S-JA197	DDMC47C1S-JA197	DDMP47C1S-VA197	DDMC47C1S-VA197	DDMMD47X1S-J	DDMMG47X1S-J	DDM47X1S-JNMBK52

\* For 50 ohm coaxial inserts replace C with X, e.g.:DCM13C6 becomes DCM13X6S-JA197

\*\*For M-3 and other hardware options, see Combo D Catalog.

\*\*\* Hardware Modifier not allowed with Non Magnetic/ Low Outgassing Combo-D- Contact factory for more information

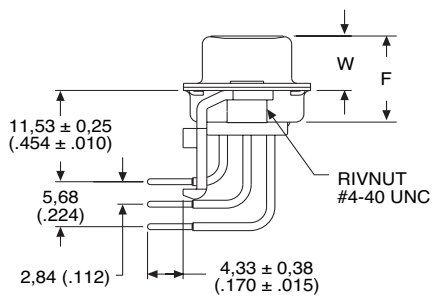

Screw lock, boardlock, and coaxial contacts removed for clarity

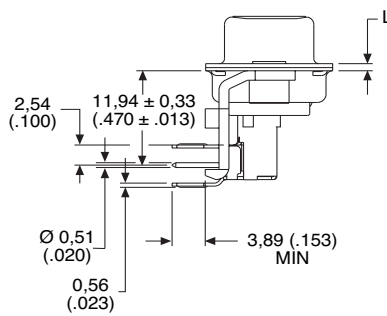

Screw lock, boardlock, and signal contacts removed for clarity

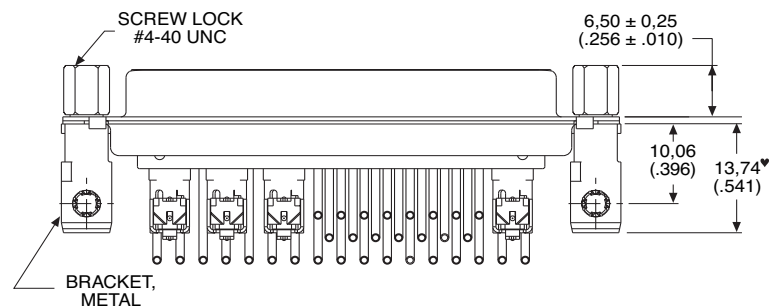

Engaging Face

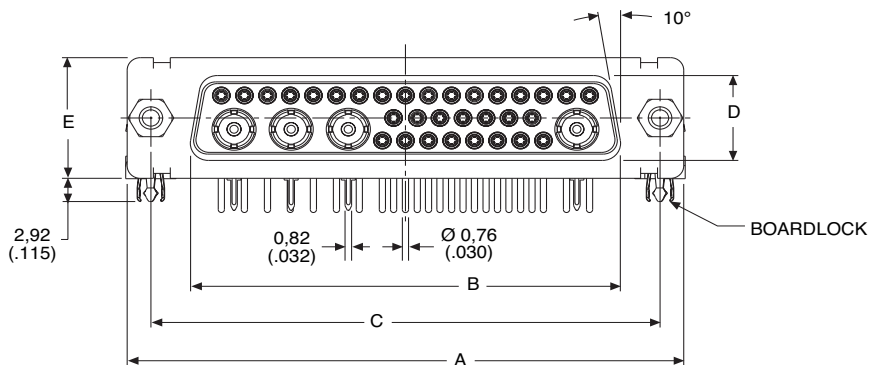

Note: Dimension varies with alternate bracket configuration.

US version shown – for EU version, please see Combo D Catalog.  
For 50 ohm coaxial version, see Combo D Catalog.

### Dimensions

Shell size	A	B	C	D	E	F	W	L
DD	66,93 (2.635)	52,42 (2.064)	61,11 (2,406)	10,74 (.423)	15,37 (.605)	10,90 (.429)	6,94 (.273)	0,76 (.030)



Dimensions shown in inches (mm)  
Specifications and dimensions subject to change

www.ittcannon.com

## 40 A High power 90° PCB Plug, Sizes DE-DC, with metal bracket

### Plug



- For contact cavity arrangements, see page C-43.
- For pcb hole pattern, see Combo D Catalog.

		INDUSTRIAL – US 40 A High power inserted with US footprint metal bracket and UNC 4-40 captive nut		INDUSTRIAL – EU 40 A High power inserted with EU footprint metal bracket and UNC 4-40 captive nut		MILITARY/HI-REL – US 40 A High power inserted with US footprint metal bracket and UNC 4-40 screw lock		NON-MAGNETIC/LOW OUTGASSING – US* 40 A High power inserted with US footprint metal bracket and UNC 4-40 screw lock
Shell size	Layout	P/N without boardlock	P/N with boardlock	P/N without boardlock	P/N with boardlock	P/N without boardlock	P/N with boardlock	P/N with Gold Plating
DE	2W2	DEMP2H2P-JK87	DEMC2H2P-JK87	DEMP2P2P-VK87	DEMC2PK2P-VK87	DEMMP2H2P-J	DEMMP2H2P-J	DEM2H2P-JNMBK52
DE	2WK2	DEMP2HK2P-JK87	DEMC2HK2P-JK87	DEMP2PK2P-VK87	DEMC2PK2P-VK87	DEMMP2HK2P-J	DEMMP2HK2P-J	DEM2HK2P-JNMBK52
DE	5W1	DEMP5H1P-JK87	DEMC5H1P-JK87	DEMP5P1P-VK87	DEMC5P1P-VK87	DEMMP5H1P-J	DEMMP5H1P-J	DEM5H1P-JNMBK52
DA	7W2	DAMP7H2P-JK87	DAMC7H2P-JK87	DAMP7P2P-VK87	DAMC7P2P-VK87	DAMMP7H2P-J	DAMMP7H2P-J	DAM7H2P-JNMBK52
DA	11W1	DAMP11H1P-JK87	DAMC11H1P-JK87	DAMP11P1P-VK87	DAMC11P1P-VK87	DAMMP11H1P-J	DAMMP11H1P-J	DAM11H1P-JNMBK52
DA	3W3	DAMP3H3P-JK87	DAMC3H3P-JK87	DAMP3P3P-VK87	DAMC3P3P-VK87	DAMMP3H3P-J	DAMMP3H3P-J	DAM3H3P-JNMBK52
DA	3WK3	DAMP3HK3P-JK87	DAMC3HK3P-JK87	DAMP3PK3P-VK87	DAMC3PK3P-VK87	DAMMP3HK3P-J	DAMMP3HK3P-J	DAM3HK3P-JNMBK52
DB	5W5	DBMP5H5P-JK87	DBMC5H5P-JK87	DBMP5P5P-VK87	DBMC5P5P-VK87	DBMMP5H5P-J	DBMMP5H5P-J	DBM5H5P-JNMBK52
DB	9W4	DBMP9H4P-JK87	DBMC9H4P-JK87	DBMP9P4P-VK87	DBMC9P4P-VK87	DBMMP9H4P-J	DBMMP9H4P-J	DBM9H4P-JNMBK52
DB	13W3	DBMP13H3P-JK87	DBMC13H3P-JK87	DBMP13P3P-VK87	DBMC13P3P-VK87	DBMMP13H3P-J	DBMMP13H3P-J	DBM13H3P-JNMBK52
DB	17W2	DBMP17H2P-JK87	DBMC17H2P-JK87	DBMP17P2P-VK87	DBMC17P2P-VK87	DBMMP17H2P-J	DBMMP17H2P-J	DBM17H2P-JNMBK52
DB	21W1	DBMP21H1P-JK87	DBMC21H1P-JK87	DBMP21P1P-VK87	DBMC21P1P-VK87	DBMMP21H1P-J	DBMMP21H1P-J	DBM21H1P-JNMBK52
DC	8W8	DCMP8H8P-JK87	DCMC8H8P-JK87	DCMP8P8P-VK87	DCMC8P8P-VK87	DCMMP8H8P-J	DCMMP8H8P-J	DCM8H8P-JNMBK52
DC	13W6	DCMP13H6P-JK87	DCMC13H6P-JK87	DCMP13P6P-VK87	DCMC13P6P-VK87	DCMMP13H6P-J	DCMMP13H6P-J	DCM13H6P-JNMBK52
DC	17W5	DCMP17H5P-JK87	DCMC17H5P-JK87	DCMP17P5P-VK87	DCMC17P5P-VK87	DCMMP17H5P-J	DCMMP17H5P-J	DCM17H5P-JNMBK52
DC	21WA4	DCMP21HA4P-JK87	DCMC21HA4P-JK87	DCMP21PA4P-VK87	DCMC21PA4P-VK87	DCMMP21HA4P-J	DCMMP21HA4P-J	DCM21HA4P-JNMBK52
DC	25W3	DCMP25H3P-JK87	DCMC25H3P-VK87	DCMP25P3P-VK87	DCMC25P3P-VK87	DCMMP25H3P-J	DCMMP25H3P-J	DCM25H3P-JNMBK52
DC	27W2	DCMP27H2P-JK87	DCMC27H2P-VK87	DCMP27P2P-VK87	DCMC27P2P-VK87	DCMMP27H2P-J	DCMMP27H2P-J	DCM27H2P-JNMBK52

\* Hardware Modifier not allowed with Non Magnetic/ Low Outgassing Combo-D-; contact factory for more information

US version shown – for EU version, please see Combo D Catalog.

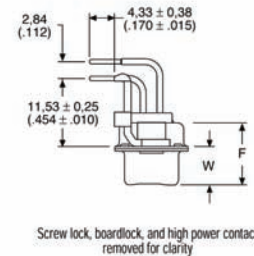
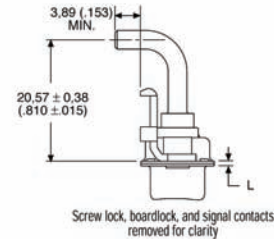
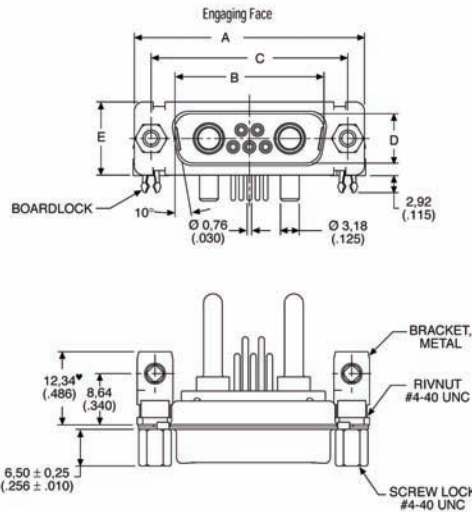

### Dimensions

Shell size	A ± 0,38 (.015)	B ± 0,13 (.005)	C ± 0,13 (.005)	D ± 0,13 (.005)	E ± 0,38 (.015)	F ± 0,25 (.010)	W ± 0,368 (.0145)	W ± 0,41 (.016)	L ± 0,25 (.010)
DE	30,81 (1.213)	16,92 (.665)	24,99 (.984)	8,36 (.329)	12,55 (.494)	10,72 (.422)	6,693 (.2635)	—	0,76 (.030)
DA	39,14 (1.541)	25,25 (.994)	33,32 (1.312)	8,36 (.329)	12,55 (.494)	10,72 (.422)	6,693 (.2635)	—	0,76 (.030)
DB	53,04 (2.088)	38,96 (1.534)	47,04 (1.852)	8,36 (.329)	12,55 (.494)	10,82 (.426)	—	6,84 (.269)	0,99 (.039)
DC	69,32 (2.729)	55,42 (2.182)	63,50 (2.500)	8,36 (.329)	12,55 (.494)	10,82 (.426)	—	6,84 (.269)	0,99 (.039)

Dimensions shown in inches (mm)  
Specifications and dimensions subject to change

# Cannon Combo D® High Power 90° PCB Plug DD Military/High Reliability

## 40 A High power 90° PCB Plug, Size DD, with metal bracket

### Plug

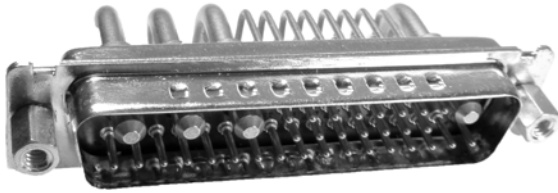

- For contact cavity arrangements, see page C-43.
- For pcb hole pattern, see Combo D Catalog.

### 40 A High power inserted with US footprint metal bracket and UNC 4-40 captive nut

Shell size	Layout	INDUSTRIAL		MILITARY/HI-REL		NON-MAGNETIC/LOW OUTGASSING*
		P/N without Boardlock	P/N with Boardlock	P/N without Boardlock	P/N with UNC Boardlock	P/N with Gold Plating
DD	24WK7	DDMP24H7P-JK87	DDMC24H7P-JK87	DDMMP24H7P-J	DDMMC24H7P-J	DDM24H7P-JNMBK52
DD	36W4	DDMP36H4P-JK87	DDMC36H4P-JK87	DDMMP36H4P-J	DDMMC36H4P-J	DDM36H7P-JNMBK52
DD	43W2	DDMP43H2P-JK87	DDMC43H2P-JK87	DDMMP43H2P-J	DDMMC43H2P-J	DDM43H7P-JNMBK52
DD	47W1	DDMP47H1P-JK87	DDMC47H1P-JK87	DDMMP47H1P-J	DDMMC47H1P-J	DDM47H7P-JNMBK52

\* Hardware Modifier not allowed with Non Magnetic/ Low Outgassing Combo-D; contact factory for more information

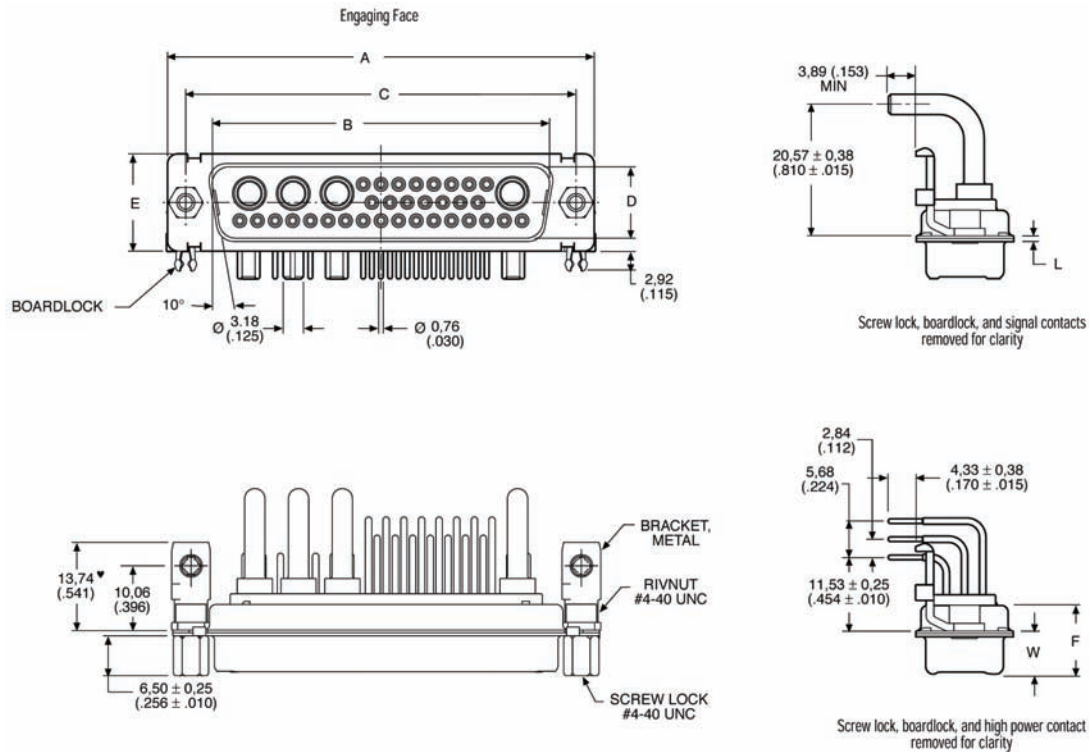

### Dimensions

Shell size	A	B	C	D	E	F	W	L
DD	66,93 (2.635)	52,81 (2.079)	61,11 (2.406)	11,07 (.436)	15,37 (.605)	10,82 (.426)	6,84 (.269)	0,99 (.039)



Dimensions shown in inches (mm)  
Specifications and dimensions subject to change

www.ittcannon.com

D Sub C

# Cannon Combo D® High Power 90° PCB Receptacle DE-DC Military/High Reliability

## 40 A High power 90° PCB Receptacle, Sizes DE-DC, with metal bracket

### Receptacle

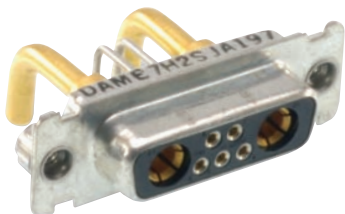

- For contact cavity arrangements, see page C-43.
- For pcb hole pattern, see Combo D Catalog.

**INDUSTRIAL – US**  
40 A High power inserted with US footprint metal bracket and UNC 4-40 captive nut

**INDUSTRIAL – EU**  
40 A High power inserted with EU footprint metal bracket and UNC 4-40 captive nut

**MILITARY/HI-REL – US**  
40 A High power inserted with US footprint metal bracket and UNC 4-40 captive nut

**NON-MAGNETIC/LOW OUTGASSING – US\***  
40 A High power inserted with US footprint metal bracket and UNC 4-40 screw lock

Shell size	Layout	P/N without Boardlock	P/N with Boardlock	P/N without Boardlock	P/N with Boardlock	P/N without Boardlock	P/N with Boardlock	P/N with Gold Plating
DE	2W2	DEMP2H2S-VA197	DEMC2H2S-VA197	DEMP2P2S-JA197	DEMC2P2S-JA197	DEMMP2H2S-V	DEMMC2H2S-V	DEM2H2S-VNMBK52
DE	2WK2	DEMP2HK2S-VA197	DEMC2HK2S-VA197	DEMP2PK2S-JA197	DEMC2PK2S-JA197	DEMMP2HK2S-V	DEMMC2HK2S-V	DEM2HK2S-VNMBK52
DE	5W1	DEMP5H1S-VA197	DEMC5H1S-VA197	DEMP5P1S-JA197	DEMC5P1S-JA197	DEMMP5H1S-V	DEMMC5H1S-V	DEM5H1S-VNMBK52
DA	7W2	DAMP7H2S-VA197	DAMC7H2S-VA197	DAMP7P2S-JA197	DAMC7P2S-JA197	DAMMP7H2S-V	DAMMC7H2S-V	DAM7H2S-VNMBK52
DA	11W1	DAMP11H1S-VA197	DAMC11H1S-VA197	DAMP11P1S-JA197	DAMC11P1S-JA197	DAMMP11H1S-V	DAMMC11H1S-V	DAM11H1S-VNMBK52
DA	3W3	DAMP3H3S-VA197	DAMC3H3S-VA197	DAMP3P3S-JA197	DAMC3P3S-JA197	DAMMP3H3S-V	DAMMC3H3S-V	DAM3H3S-VNMBK52
DA	3WK3	DAMP3HK3S-VA197	DAMC3HK3S-VA197	DAMP3PK3S-JA197	DAMC3PK3S-JA197	DAMMP3HK3S-V	DAMMC3HK3S-V	DAM3HK3S-VNMBK52
DB	5W5	DBMP5H5S-VA197	DBMC5H5S-VA197	DBMP5P5S-JA197	DBMC5P5S-JA197	DBMMP5H5S-V	DBMMC5H5S-V	DBM5H5S-VNMBK52
DB	9W4	DBMP9H4S-VA197	DBMC9H4S-VA197	DBMP9P4S-JA197	DBMC9P4S-JA197	DBMMP9H4S-V	DBMMC9H4S-V	DBM9H4S-VNMBK52
DB	13W3	DBMP13H3S-VA197	DBMC13H3S-VA197	DBMP13P3S-JA197	DBMC13P3S-JA197	DBMMP13H3S-V	DBMMC13H3S-V	DBM13H3S-VNMBK52
DB	17W2	DBMP17H2S-VA197	DBMC17H2S-VA197	DBMP17P2S-JA197	DBMC17P2S-JA197	DBMMP17H2S-V	DBMMC17H2S-V	DBM17H2S-VNMBK52
DB	21W1	DBMP21H1S-VA197	DBMC21H1S-VA197	DBMP21P1S-JA197	DBMC21P1S-JA197	DBMMP21H1S-V	DBMMC21H1S-V	DBM21H1S-VNMBK52
DC	8W8	DCMP8H8S-VA197	DCMC8H8S-VA197	DCMP8P8S-JA197	DCMC8P8S-JA197	DCMMP8H8S-V	DCMMC8H8S-V	DCM8H8S-VNMBK52
DC	13W6	DCMP13H6S-VA197	DCMC13H6S-VA197	DCMP13P6S-JA197	DCMC13P6S-JA197	DCMMP13H6S-V	DCMMC13H6S-V	DCM13H6S-VNMBK52
DC	17W5	DCMP17H5S-VA197	DCMC17H5S-VA197	DCMP17P5S-JA197	DCMC17P5S-JA197	DCMDMP17H5S-V	DCMCMC17H5S-V	DCM17H5S-VNMBK52
DC	21WA4	DCMP21HA4S-VA197	DCMC21HA4S-VA197	DCMP21PA4S-JA197	DCMC21PA4S-JA197	DCMMP21HA4S-V	DCMCMC21HA4S-V	DCMG21HA4S-VNMBK52
DC	25W3	DCMP25H3S-VA197	DCMC25H3S-VA197	DCMP25P3S-JA197	DCMC25P3S-JA197	DCMMP25H3S-V	DCMMC25H3S-V	DCM25H3S-VNMBK52
DC	27W2	DCMP27H2S-VA197	DCMC27H2S-VA197	DCMP27P2S-JA197	DCMC27P2S-JA197	DCMMP27H2S-V	DCMMC27H2S-V	DCM27H2S-VNMBK52

\* Hardware Modifier not allowed with Non Magnetic/ Low Outgassing Combo-D; contact factory for more information

US version shown – for EU version, please see Combo D Catalog.

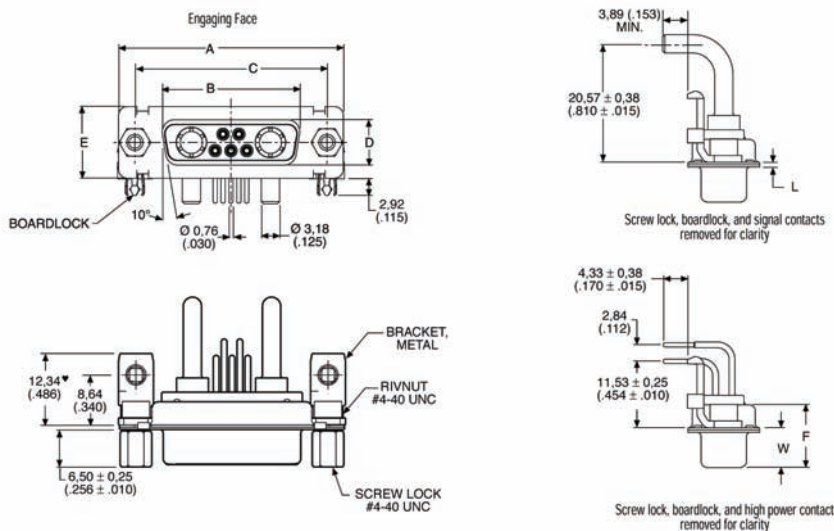

### Dimensions

Shell size	A ± 0,38 (.015)	B ± 0,13 (.005)	C ± 0,13 (.005)	D ± 0,13 (.005)	E ± 0,38 (.015)	F ± 0,25 (.010)	W ± 0,38 (.015)	L ± 0,25 (.010)
DE	30,81 (1.213)	16,33 (.643)	24,99 (.984)	7,90 (.311)	12,55 (.494)	10,90 (.429)	6,94 (.273)	0,76 (.030)
DA	39,14 (1.541)	24,65 (.971)	33,32 (1.312)	7,90 (.311)	12,55 (.494)	10,90 (.429)	6,94 (.273)	0,76 (.030)
DB	53,04 (2.088)	38,38 (1.511)	47,04 (1.852)	7,90 (.311)	12,55 (.494)	10,90 (.429)	6,94 (.273)	0,76 (.030)
DC	69,32 (2.729)	54,84 (2.159)	63,50 (2.500)	7,90 (.311)	12,55 (.494)	10,90 (.429)	6,94 (.273)	0,76 (.030)

Dimensions shown in inches (mm)  
Specifications and dimensions subject to change



# Cannon Combo D® High Power 90° PCB Receptacle DD Military/High Reliability

## 40 A High power 90° PCB Receptacle, Size DD, with metal bracket

Plug



- For contact cavity arrangements, see page C-43.
- For pcb hole pattern, see Combo D Catalog.

## 40 A High power inserted with US footprint metal bracket and UNC 4-40 captive nut

Shell size	Layout	INDUSTRIAL		MILITARY/HI-REL		NON-MAGNETIC/LOW OUTGASSING*
		P/N without Boardlock	P/N with Boardlock	P/N without Boardlock	P/N with UNC Boardlock	P/N with Gold Plating
DD	24WK7	DDMP24H7S-JA197	DDMC24H7S-JA197	DDMMP24H7S-J	DDMMC24H7S-J	DDM24H7S-JNMBK52
DD	36W4	DDMP36H4S-JA197	DDMC36H4S-JA197	DDMMP36H4S-J	DDMMC36H4S-J	DDM36H4S-JNMBK52
DD	43W2	DDMP43H2S-JA197	DDMC43H2S-JA197	DDMMP43H2S-J	DDMMC43H2S-J	DDM43H2S-JNMBK52
DD	47W1	DDMP47H1S-JA197	DDMC47H1S-JA197	DDMMP47H1S-J	DDMMC47H1S-J	DDM47H1S-JNMBK52

\* Hardware Modifier not allowed with Non Magnetic/ Low Outgassing Combo-D; contact factory for more information

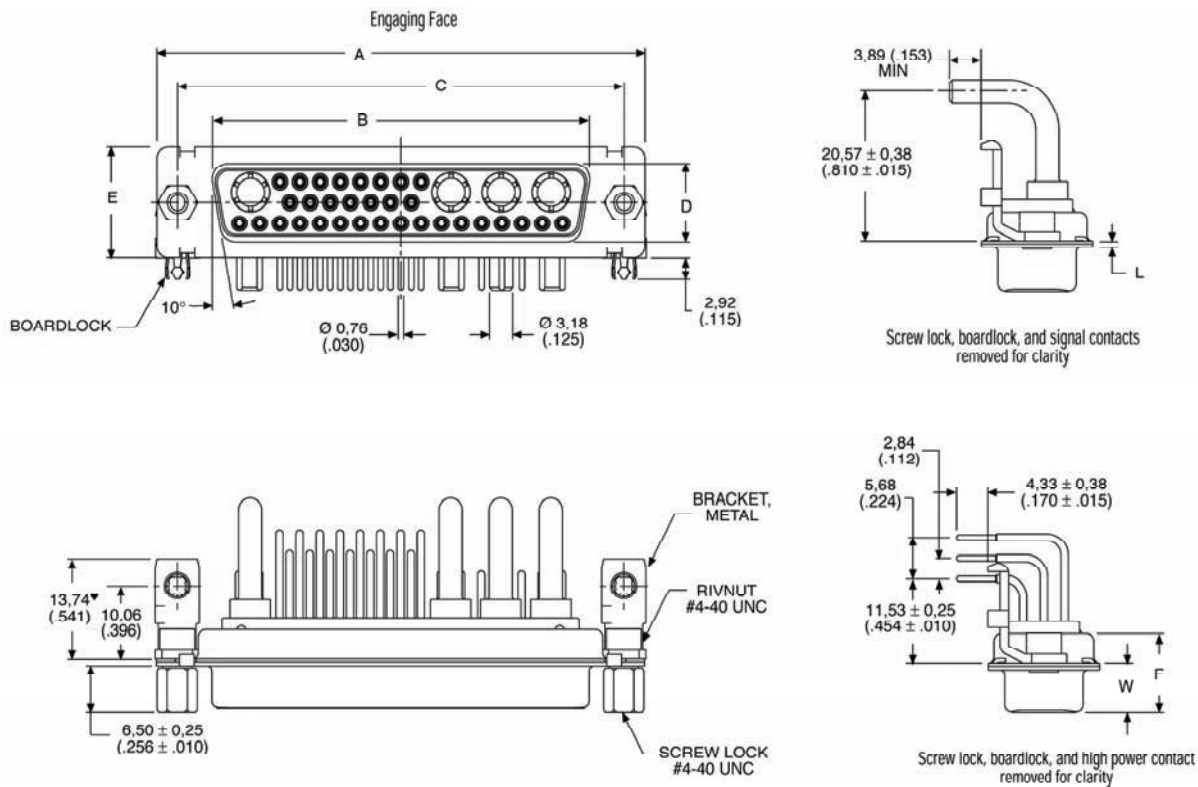

### Dimensions

Shell size	A	B	C	D	E	F	W	L
	± 0,38 (.015)	± 0,13 (.005)	± 0,13 (.005)	± 0,13 (.005)	± 0,38 (.015)	± 0,25 (.010)	± 0,38 (.015)	± 0,25 (.010)
DD	66,93 (2.635)	52,42 (2.064)	61,11 (2.406)	10,74 (.423)	15,37 (.605)	10,90 (.429)	6,94 (.273)	0,76 (.030)



Dimensions shown in inches (mm)  
Specifications and dimensions subject to change



Grommet D

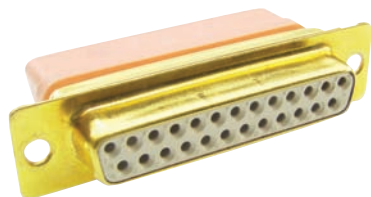

- Environmental Protection
- MIL-C-4308 Compatibility
- Reliability and Versatility

GD\* connectors are ideal for aerospace, military, telecommunications and other applications requiring protection and high reliability.

ITT Cannon developed GD\* connectors to meet the needs of the avionics industry. These connectors provide high-density and moisture protection.

Environmental protection is accomplished by the resilient grommet, interfacial seal, and bonded connector components.

Performance and Material Specifications

MATERIALS AND FINISHES

	Materials	Finishes
Shell	Low carbon steel per ASTM-A-620	Yellow chromate over cadmium per QQ-P-415, Type II, Class 2
Contacts	Copper alloy	Standard finish: Gold over nickel Military finish: Gold 50 microinches thickness per MIL-G-45204, Type II, Grade C, Class 1, over copper per MIL-C-14550
Float Mount Hardware	Stainless Steel	Passivated per QQ-P-35
Grommets and Seals	Silicone elastomer or Fluorosilicone	
Bonding Material	Epoxy	

MECHANICAL FEATURES

Wire Accommodation – Contact: #20, #22, #24 AWG.

Wire O.D. .071 (1.80) maximum, .038 (0.97) minimum.

Contact Retention – 9 lbs. minimum (40N) after 10 insertions

ELECTRICAL DATA

Test voltage AC RMS 60 Hz

	Sea Level	20,000 Ft.	50,000 Ft.	70,000 Ft.
Average Flashover	1,000	1,000	500	500
Test	1,000	650	325	325

Maximum Current Carrying Capacity of Contacts – #20 Contacts: 5 Amps

Temperature Range – -65°C to +150°C (-53.9°F to +302°F)

How to Order

SERIES PREFIX  
GD – Grommet D

SHELL SIZE  
E, A, B, C, D

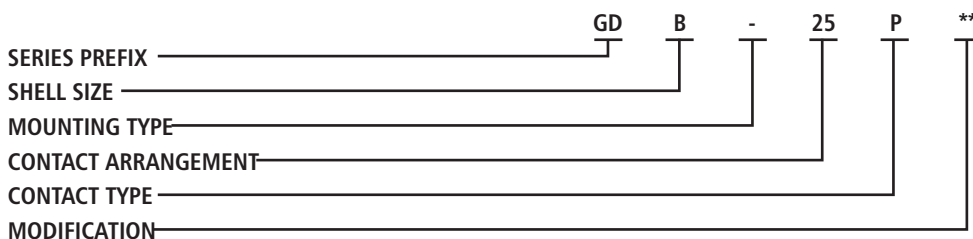

**MOUNTING TYPE**  
No designator – .120 (3.05) Diameter Mounting Holes

Y – Float Mount for Rear and Front Panel Mounting

**CONTACT ARRANGEMENTS**  
Std. Density 9, 15, 25, 37 and 50  
Hi Density 15, 26, 44, 62, 78

**CONTACT TYPE**  
P – Pin, crimp termination  
S – Socket, crimp termination

**MODIFICATIONS** (Typical Modifiers)  
FO – Connectors supplied Less Contacts

See D\*MA modifiers, page C-8.

# Grommet D GD\*

## Standard Shell Dimensions

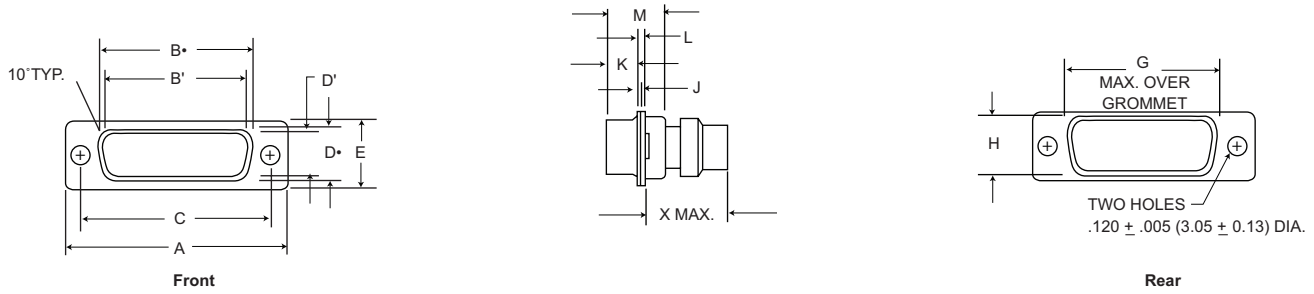

## Shell with Float Dimensions

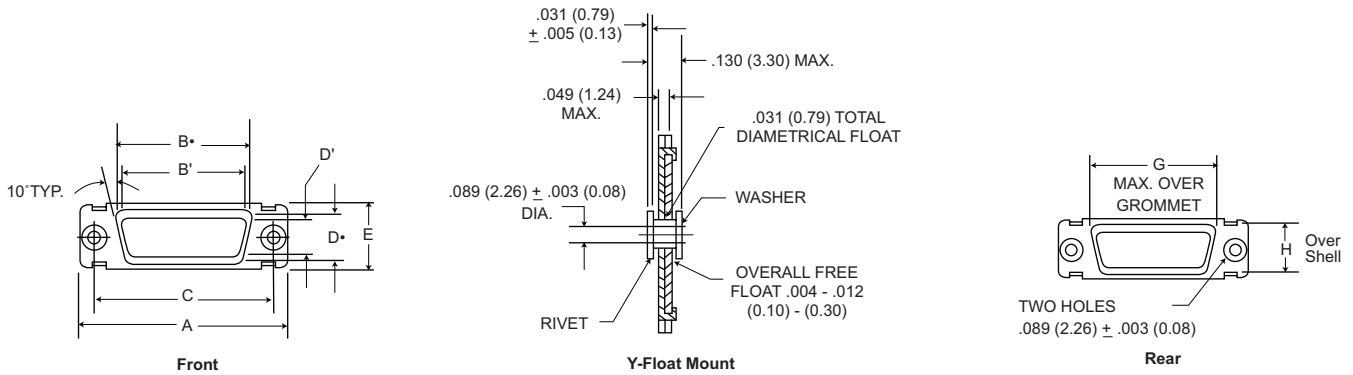

It is recommended that only one assembly, either pin or socket, be float mounted. For front panel mounting use reverse float mounted.

Shell Size	A	B*	B'	C	D*	D'	E	G	H	J	K	L	M	X
	±.015 (0.38)	±.005 (0.13)	±.005 (0.13)	±.005 (0.12)	±.005 (0.13)	±.005 (0.12)	±.015 (0.38)	Max.	±.010 (0.25)	±.010 (0.25)	±.006 (0.13)	±.010 (0.25)	±.085 (0.13)	Max.
GDE-9P	1.213 (30.81)	—	.666 (16.91)	.984 (24.99)	—	.329 (8.36)	.494 (12.55)	.750 (19.05)	.422 (10.72)	.030 (0.76)	.235 (5.97)	.045 (1.14)	.422 (10.72)	.718 (18.24)
GDE-9S	1.213 (30.81)	.643 (16.33)	—	.984 (24.99)	.311 (7.90)	—	.494 (12.55)	.750 (19.05)	.422 (10.72)	.030 (0.76)	.243 (6.17)	.045 (1.14)	.429 (10.90)	.718 (18.24)
GDA-15P	1.541 (39.14)	—	.994 (25.24)	1.312 (33.32)	—	.329 (8.36)	.494 (12.55)	1.093 (27.76)	.422 (10.72)	.030 (0.76)	.235 (5.97)	.045 (1.14)	.422 (10.72)	.718 (18.24)
GDA-15S	1.541 (39.14)	.971 (24.66)	—	1.312 (33.32)	.311 (7.90)	—	.494 (12.55)	1.093 (27.76)	.422 (10.72)	.030 (0.76)	.243 (6.17)	.045 (1.14)	.429 (10.90)	.718 (18.24)
GDB-25P	2.088 (53.03)	—	1.534 (38.96)	1.852 (47.04)	—	.329 (8.36)	.494 (12.55)	1.625 (41.28)	.422 (10.72)	.039 (0.99)	.230 (5.84)	.060 (1.52)	.426 (10.82)	.718 (18.24)
GDB-25S	2.088 (53.03)	1.511 (38.38)	—	1.852 (47.04)	.311 (7.90)	—	.494 (12.55)	1.625 (41.28)	.422 (10.72)	.030 (0.76)	.243 (6.17)	.045 (1.14)	.429 (10.90)	.718 (18.24)
GD-37P	2.729 (19.32)	—	2.182 (55.42)	2.50 (63.50)	—	.329 (8.36)	.494 (12.55)	2.270 (57.66)	.422 (10.72)	.039 (0.99)	.230 (5.84)	.060 (1.52)	.426 (10.82)	.718 (18.24)
GD-37S	2.729 (19.32)	2.159 (54.84)	—	2.50 (63.50)	.311 (7.90)	—	.494 (12.55)	2.270 (57.66)	.422 (10.72)	.030 (0.76)	.243 (6.17)	.045 (1.14)	.429 (10.90)	.718 (18.24)
GDD-50P	2.635 (66.92)	—	2.079 (52.81)	2.406 (61.11)	—	.411 (11.20)	.605 (15.37)	2.162 (54.91)	.534 (13.56)	.039 (0.99)	.230 (5.84)	.060 (1.52)	.426 (10.82)	.718 (18.24)
GDD-50S	2.635 (66.92)	2.064 (52.42)	—	2.406 (61.11)	.423 (10.74)	—	.605 (15.37)	2.162 (54.91)	.534 (13.56)	.030 (0.76)	.243 (6.17)	.045 (1.14)	.429 (10.90)	.718 (18.24)

\*dimensions B, D, and H are measured as outside dimensions at the bottom of draw.

**NOTE:** B\* and D\* are the outside dimensions for socket side, B' and D' are the inside dimensions for pin side.  
High Density Layouts available.

## Test Data

GD\* connectors meet all applicable requirements of MIL-C-24308. The following are excerpts from ITT Cannon Test Cannon Test Report C82-78 applicable to environmental D-Subminiature GD\* series connectors. Refer to MIL-C- 24308 Test Extracts on page 385.

Test Description	Test Method	Results
Moisture Resistant	MIL-STD-1344 Method 1002.1 Type II	<ol style="list-style-type: none"> <li>1. No deterioration of performance.</li> <li>2. Insulation resistance greater than 100 megaohms.</li> <li>3. No evidence of flashover or breakdown during 1000 VAC DWV testing.</li> </ol>
Fluid Immersion	20 hours immersion in hydraulic fluid per MIL-L-23699.	<ol style="list-style-type: none"> <li>1. No detrimental damage.</li> <li>2. Able to meet requirements of mating and unmating test.</li> </ol>
Immersion	Two hours immersion in tap water at a depth of 36.00 (914.40) in mated condition, per MIL-STD 810, Method 512, Procedure 1.	While still immersed, the mated connectors exceeded 100 megaohm insulator resistance and exhibited no evidence of breakdown or flashover during 1000 VAC (RMS) DWV testing.

## Design Features

- Resilient silicone grommets for wire sealing
- Interfacial seals
- Closed-entry socket contacts
- Bonded components to prevent moisture
- Uses M39029 type contacts and termination tooling
- Intermateable with most M24308 type connectors
- Rear-release crimp contacts
- LITTLE CAESAR® contact retention assembly
- Optional sealing plugs, ITT Cannon part number

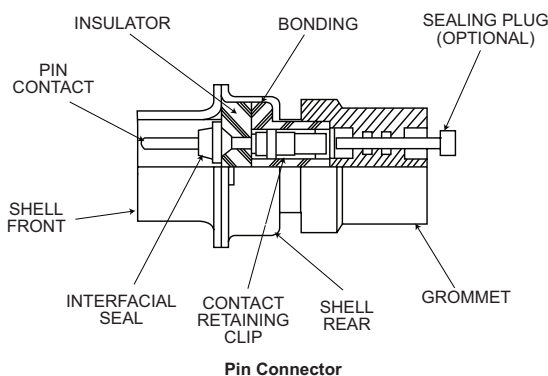
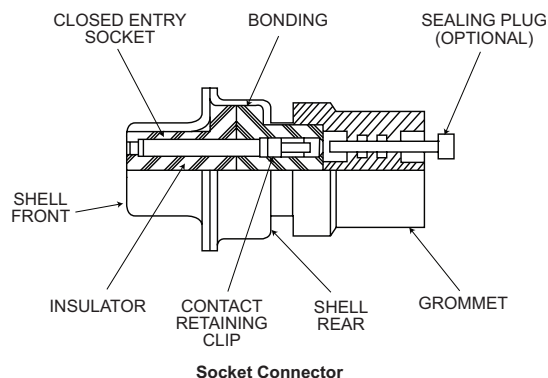

Note: Crimp Contacts: See page C-13

D\*D



The Cannon D\*D Environmental Series is designed to meet the demand for subminiature rectangular plugs with superior vibration and moisture resistance characteristics for aircraft, missile, and ground support equipment applications.

Featuring a rugged aluminum shell and peripheral seal, the D\*D connector meets all applicable requirements of MIL-C-24308. Available in both sol-

der and crimp versions, all assemblies are provided with nylon potting cups and dust caps.

Solder type contacts are non-removable and are factory-installed. Crimp type connectors utilize the field-proven LITTLE CAESAR® rear insertion, rear-release retention system.

**PLEASE NOTE: The D\*D Series is not interchangeable with other D Subminiature connectors.**

Performance and Material Specifications

Shell	Aluminum, cadmium plated with yellow chromate supplementary coating.
Contacts	Solder pot: Copper alloy, gold plated .00002 (.0005) over nickel .00004 (.0010) Crimp type: Copper alloy, gold plated .00002 (.0005) over nickel .00004 (.0010)
Contact Termination	Solder pot accommodating up to #20 AWG stranded wire. Crimp type accommodating #20, #22, and #24 AWG stranded wire.
Socket Type	Closed entry
Float Mounting Rivets & Washers	Stainless Steel. Passivated per DQ-P-35

Test Data

Specifications	
Voltage Rating	All voltage figures are AC (rms), 60 Hz measured at approximately 25.0°C 50% RH.
Insulation Resistance (per MIL-C-24308)	Greater than 5,000 megohms, determined in accordance with MIL-STD-202A, Method 302
Contact Voltage Drop	2.67 millivolts, maximum, per amp
Contact Separation Force	1 to 8 ounces when tested in accordance with MIL-C-24308
Air Leakage	When properly wired and potted, 1 cubic inch of air per hour max. when subjected to 30 PSI pressure differential in accordance with MIL-C-50150, Paragraph 4.5.3.1
Vibration (per MIL-C-24308)	Exceeds test requirements of MIL-STD-202A, Method 204, Condition D
Corrosion Resistance (per MIL-C-24308)	Exceeds requirements of 50 hour exposure to salt spray in accordance with MIL-STD-202A, Method 101A, Condition B
Moisture Resistance (per MIL-C-24308)	Exceeds requirements of MIL-STD-202A, Method 106
Shock	Exceeds requirements of MIL-STD-202A, Method 213, Condition G
Environmental Seal	Effective from full engagement to 1/16 short of full engagement
Contact Retention Force	(Crimp type) 8 pounds (35.6 newtons) minimum for first cycle; 5 pounds (22.2 newtons) minimum after tenth cycle
Standard Layout Plugs	Measured from contact-to-contact, and contact-to-shell in unmated condition

ALTITUDE (FEET)

	Sea Level	20,000	50,000	70,000
Average Flashover	1700	1000	650	500
Test	1250	750	475	375

0.0000

C

D Sub

How to Order

Solder Cup Terminals

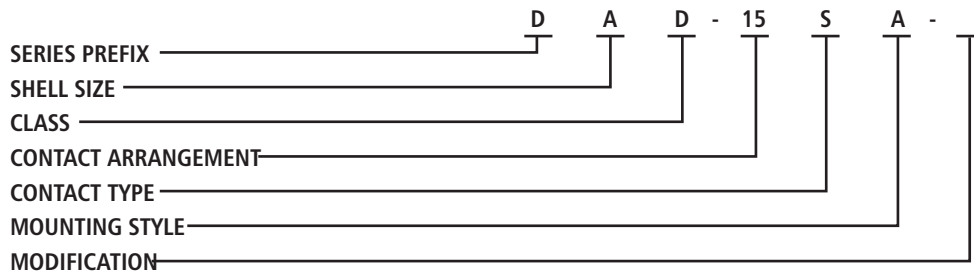

**SERIES PREFIX**  
ITT Cannon Designation

**SHELL SIZE**  
A, B, C, D, E

**CONTACT TYPE**  
P – Pin  
S – Socket

**CLASS**  
D – Environmental

**MOUNTING STYLE**  
A – Standard Mounting Holes  
B – Float Mounts supplied

**CONTACT ARRANGEMENT**  
9, 15, 25, 37, 50 Std Density  
Combo-D Layouts also available

**MODIFICATION**  
Contact factory

Snap-In Crimp Terminals

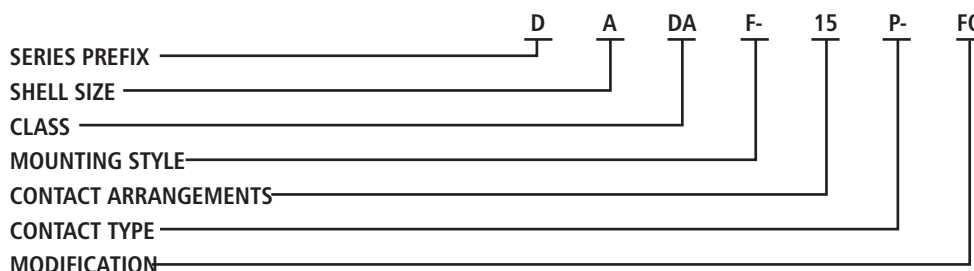

**SERIES PREFIX**  
ITT Cannon Designation

**SHELL SIZE**  
A, B, C, D, E

**CONTACT ARRANGEMENTS**  
9, 15, 25, 37, 50 Std Density  
15, 26, 44, 62, 88 Hi Density  
Combo-D Layouts also available

**CLASS**  
DA – Environmental, crimp type

**CONTACT TYPE**  
P – Pin  
S – Socket

**MOUNTING STYLE**  
No Designator – Standard mounting  
F – Float mounts supplied

**MODIFICATION**  
FO – Connector supplied less contacts, for other modifications consult factory

Panel Cutouts

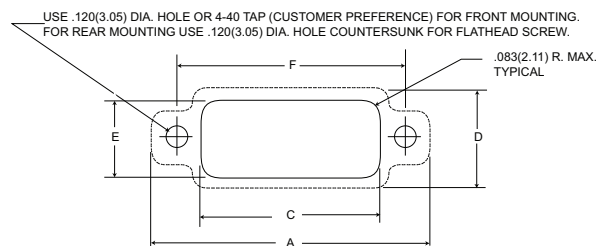

Add .032 (0.81) to dimensions C and E for float mounting.  
Note: Panel cutout does not allow for potting cup clearance.

Shell Size	A ±.010 (0.25)	C Min.	D ±.010 (0.25)	E ±.010 (0.25)	F ±.010 (0.25)
DED-15	1.442 (36.63)	.839 (21.31)	.614 (15.60)	.497 (12.62)	1.125 (28.58)
DAD-26	1.755 (44.58)	1.157 (29.39)	.614 (15.60)	.497 (12.62)	1.437 (36.50)
DBD-44	2.295 (58.29)	1.697 (43.10)	.614 (15.60)	.497 (12.62)	1.993 (50.62)
DCD-62	2.937 (74.60)	2.357 (59.87)	.614 (15.60)	.497 (12.62)	2.625 (66.68)
DDD-78	2.859 (72.62)	2.265 (57.53)	.735 (18.67)	.610 (15.49)	2.531 (64.29)

Dimensions shown in inches (mm)  
Specifications and dimensions subject to change



**Shell Dimensions, Standard Mount**

**Receptacle**

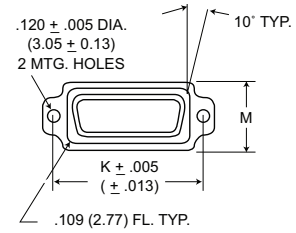
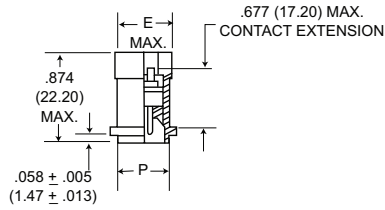
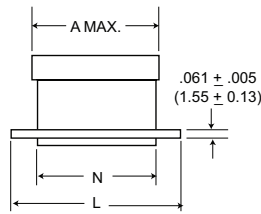

**Plug**

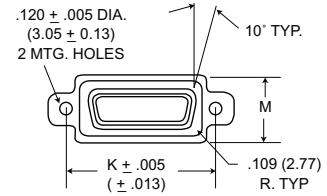
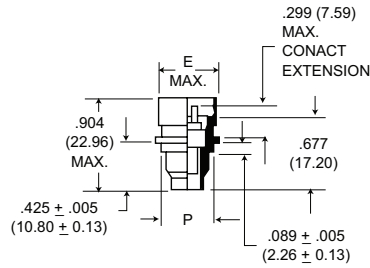
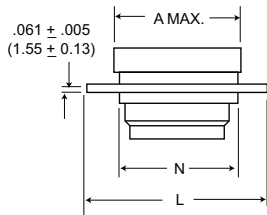

**Float Mount Dimensions**

**Receptacle**

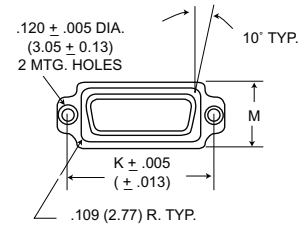
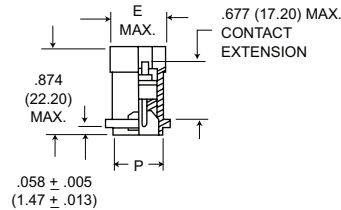
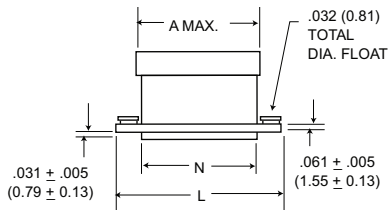

**Plug**

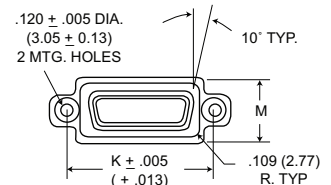
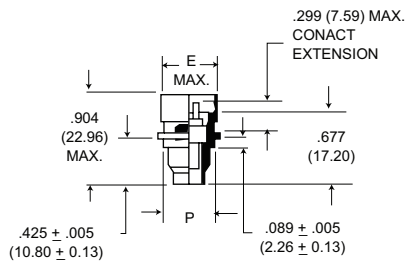
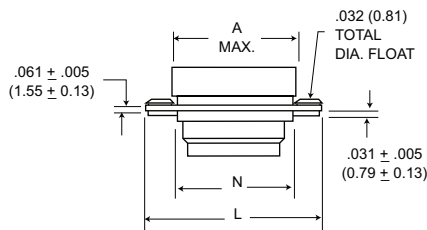

**NOTE:** All D\*D Environmental plugs and receptacles are provided with dust caps and removable potting caps.

	A	E	K	L	M	N	P
Shell Size	Max.	Max.	±.005 (0.13)	±.010 (0.25)	±.010 (0.25)	±.010 (0.25)	±.010 (0.25)
DED-9P, 15P	.915 (23.24)	.596 (15.14)	1.125 (28.58)	1.442 (36.63)	.614 (15.60)	.825 (20.86)	.483 (12.27)
DED-9S, 15S	.915 (23.24)	.596 (15.14)	1.125 (28.58)	1.442 (36.63)	.614 (15.60)	.825 (20.86)	.483 (12.27)
DAD-15P, 26P	1.233 (31.32)	.596 (15.14)	1.437 (36.50)	1.755 (44.58)	.614 (15.60)	1.143 (29.03)	.483 (12.27)
DAD-15S, 26S	1.233 (31.32)	.596 (15.14)	1.437 (36.50)	1.755 (44.58)	.614 (15.60)	1.143 (29.03)	.483 (12.27)
DBD-25P, 44P	1.786 (45.36)	.596 (15.14)	1.993 (50.62)	2.295 (58.29)	.614 (15.60)	1.683 (42.75)	.483 (12.27)
DBD-25S, 44S	1.786 (45.36)	.596 (15.14)	1.993 (50.62)	2.295 (58.29)	.614 (15.60)	1.683 (42.75)	.483 (12.27)
DCD-37P, 62P	2.458 (62.43)	.567 (14.40)	2.625 (66.68)	2.937 (74.60)	.614 (15.60)	2.343 (59.51)	.483 (12.27)
DCD-37S, 62S	2.458 (62.43)	.567 (14.40)	2.625 (66.68)	2.937 (74.60)	.614 (15.60)	2.343 (59.51)	.483 (12.27)
DDD-50P, 78P	2.390 (60.71)	.680 (17.12)	2.531 (64.29)	2.859 (72.62)	.735 (18.67)	2.251 (57.18)	.596 (15.14)
DDD-50S, 78S	2.390 (60.71)	.680 (17.12)	2.531 (64.29)	2.859 (72.62)	.735 (18.67)	2.251 (57.18)	.596 (15.14)

All tolerances are ±.010 (0.25) unless noted otherwise.



Contact Cavity Arrangements

Plug  
Face View Pin Insert  
(Use a mirror image for receptacle).

Shell Size  
Contact Arrangement  
No. of Size 20 Cavities  
No. of Size 8 Cavities



E	E	E	A	A	A	A
2W2	2WK2	5W1	3W3	3WK3	7W2	11W1
0#20	0#20	4#20	0#20	0#20	5#20	10#20
2#8	2#8	1#8	3#8	3#8	2#8	1#8

Shell Size  
Contact Arrangement  
No. of Size 20 Cavities  
No. of Size 8 Cavities



B	B	B
5W54	9W4	13W3
0#20	5#20	10#20
5#8	4#8	3#8

Shell Size  
Contact Arrangement  
No. of Size 20 Cavities  
No. of Size 8 Cavities



B	B
17W2	21W1
15#20	20#20
2#8	1#8

Shell Size  
Contact Arrangement  
No. of Size 20 Cavities  
No. of Size 8 Cavities



C	C	C
8W8	13W6	17W5
0#20	7#20	12#20
8#8	6#8	5#8

Shell Size  
Contact Arrangement  
No. of Size 20 Cavities  
No. of Size 8 Cavities

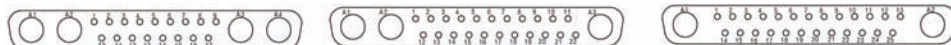

C	C	C
21WA4	25W3	27W2
17#20	22#20	25#20
4#8	3#8	2#8

Shell Size  
Contact Arrangement  
No. of Size 20 Cavities  
No. of Size 8 Cavities



D	D
24W7	36W4
17#20	32#20
7#8	4#8

Shell Size  
Contact Arrangement  
No. of Size 20 Cavities  
No. of Size 8 Cavities



D	D
43W2	47W1
41#20	46#20
2#8	1#8



# Contact Cavities and Assembly Instructions

## Contact Arrangements

Face View Pin Insert  
(Use a mirror image for receptacle).

Shell Size  
Contact Arrangement  
Contact Size

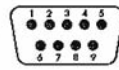

E  
9  
#20

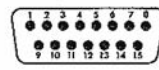

A  
15  
#20

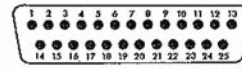

B  
25  
#20

Standard Density



C  
37  
#20



D  
50  
#20

Face View Pin Insert  
(Use a mirror image for receptacle).

Shell size  
Contact Arrangement  
Contact Size

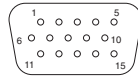

E  
15  
#22

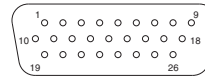

A  
26  
#22

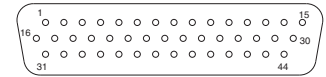

B  
44  
#22

High Density

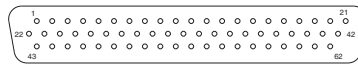

C  
62  
#22

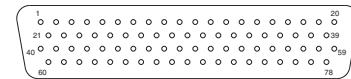

D  
78  
#22

## Assembly Instructions

### Wire-Stripping – Machine Contacts

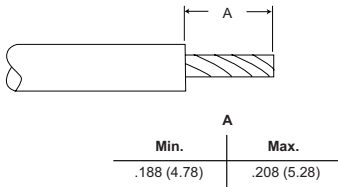

1. Cut wires to length. Strip insulation per above illustration. Check for frayed or broken wires.

### Contact Crimping



2. Insert contact and wire into proper crimp tool (and locator, if required). Crimp contact to wire. Inspect crimp.

### Contact Insertion



3. Center wired contact into groove of insertion tool with tool tip butting contact shoulder. Insert contact into cavity until a positive stop is felt. Inspect insertion.

### Contact Extraction



4. To be sure contact is locked securely, pull back lightly on wire. Repeat for balance of contacts working row by row across the insulator.



5. Place wire into extraction tool tip.



6. Insert tool tip into contact cavity until tip bottoms against contact shoulder, releasing tines. Hold wire against tool with finger and remove tool and contact. Repeat for balance of contacts.



Dimensions shown in inches (mm)  
Specifications and dimensions subject to change



## Straight PCB Plug and Receptacle

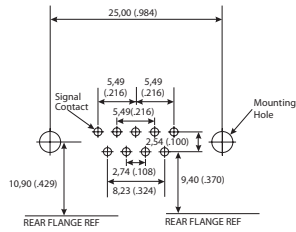

9 Contacts

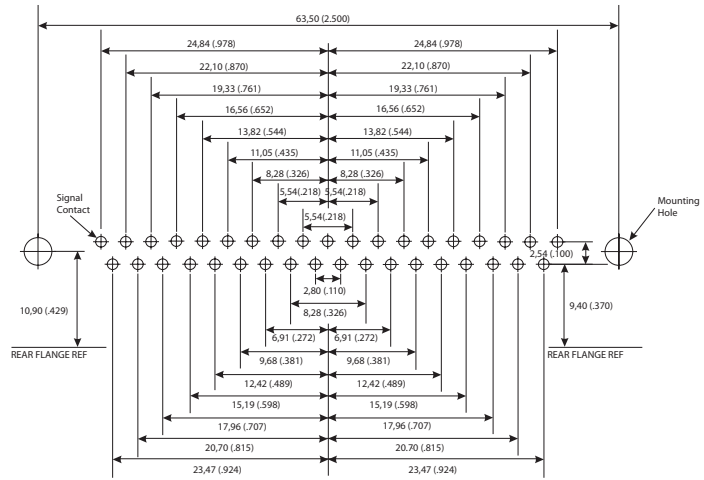

37 Contacts

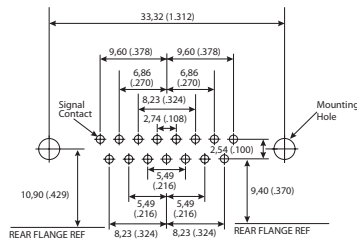

15 Contacts

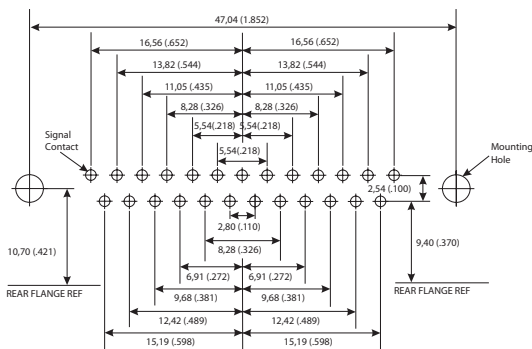

25 Contacts

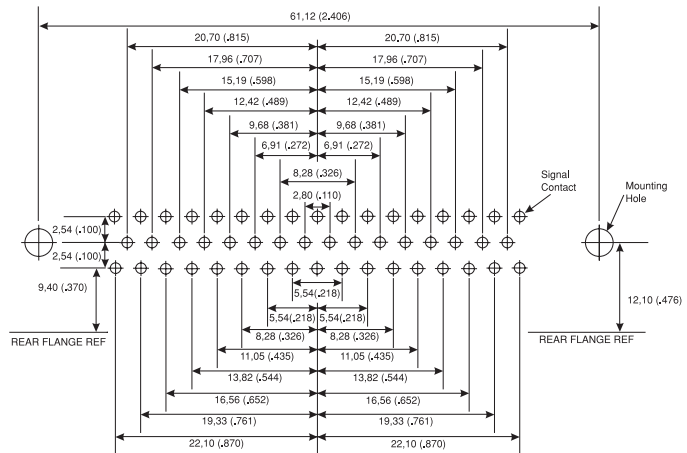

50 Contacts

Signal Contact	Recommended PCB Hole
0,60 (.024)	1,00 (.039)
Mounting Type	Recommended PCB Hole
Without Boardlock	3,05 (.120)
With Boardlock	3,10 (.122)

Dimensions shown in inches (mm)  
Specifications and dimensions subject to change

www.ittcannon.com

90° Plug and Receptacle

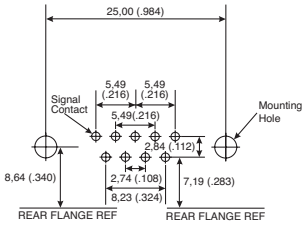

9 Contacts

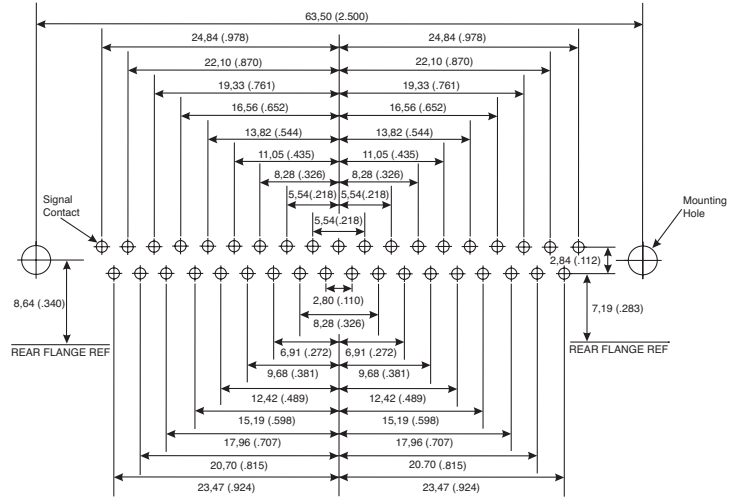

37 Contacts

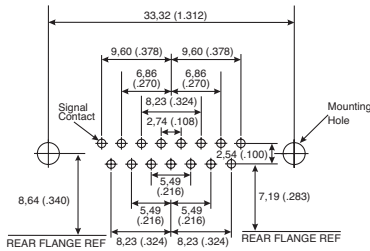

15 Contacts

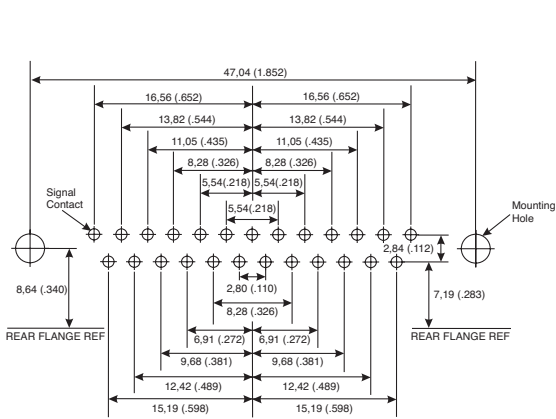

25 Contacts

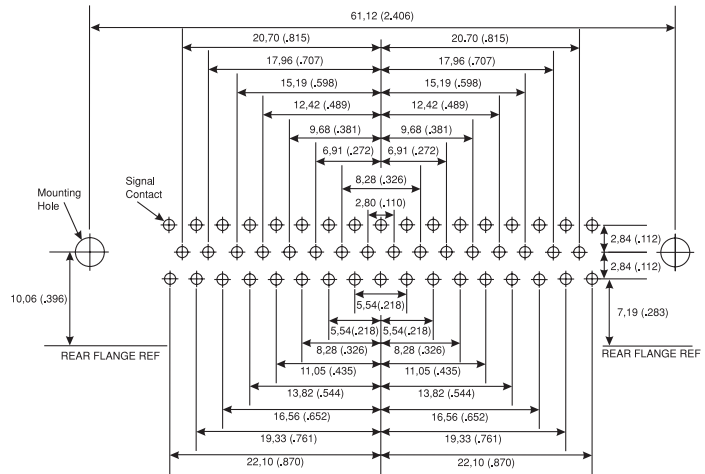

50 Contacts

Signal Contact	Recommended PCB Hole
0,76 (.030)	1,14 (.045)
1,00 (.040)	1,40 (.055)
Mounting Type	Recommended PCB Hole
Without Boardlock	3,05 (.120)
With Boardlock	3,10 (.122)

Dimensions shown in inches (mm)  
Specifications and dimensions subject to change



D Sub



Straight PCB Hole Pattern

Face view, pin insert for plug  
(use a mirror image for receptacle)

**SIZE E**  
15 Contacts

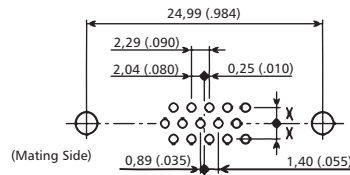

**SIZE A**  
26 Contacts

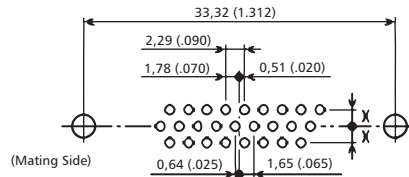

**SIZE B**  
44 Contacts

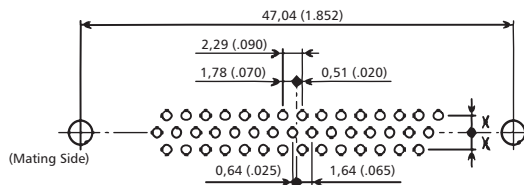

**SIZE C**  
62 Contacts

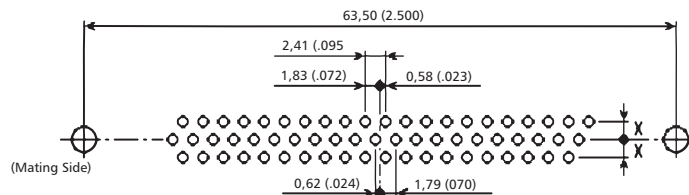

**SIZE D**  
78 Contacts

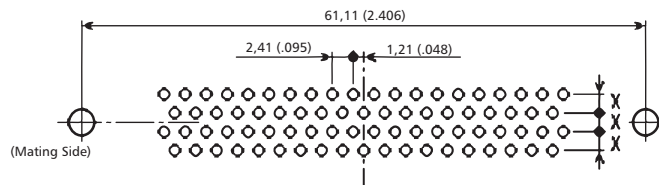

**SIZE F**  
104 Contacts

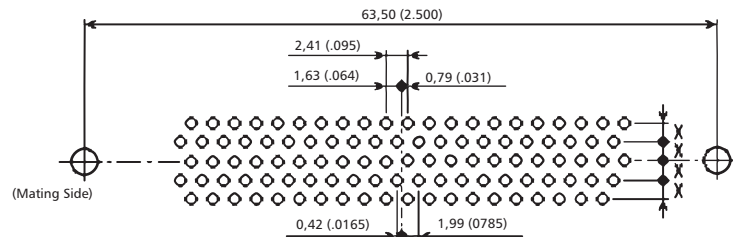

Dimension X  
1,98 (.078) for sizes E, A, B, C  
2,08 (.082) for size D

Recommended PC hole for signal contacts  
? 0,90 (.035) min for terminations ? 0,51 (.020)  
? 1,00 (.040) min for terminations ? 0,57 (.022)

Dimensions shown in inches (mm)  
Specifications and dimensions subject to change

www.ittcannon.com

D Sub

90° PCB Hole Pattern

Face view, pin insert for plug  
(use a mirror image for receptacle)

SIZE E  
15 Contacts

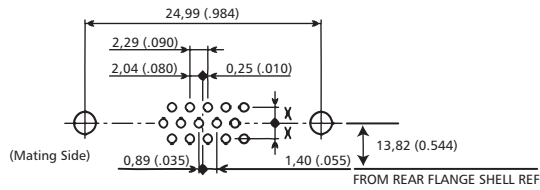

SIZE A  
26 Contacts

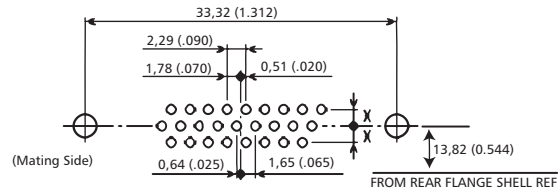

SIZE B  
44 Contacts

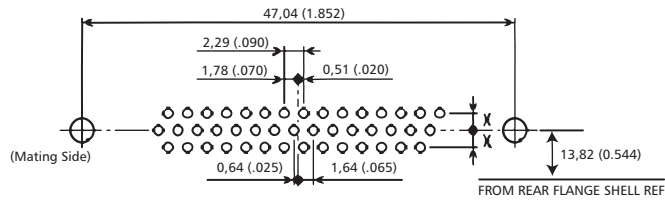

SIZE C  
62 Contacts

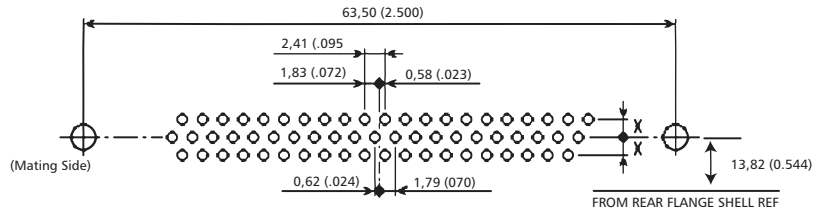

SIZE D  
78 Contacts

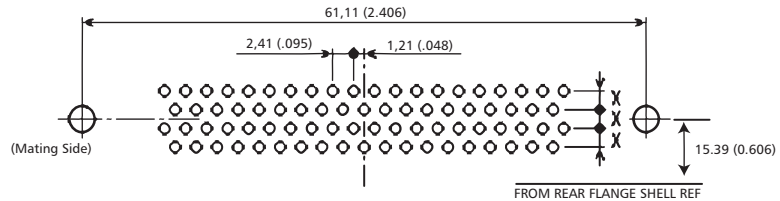

SIZE F  
104 Contacts

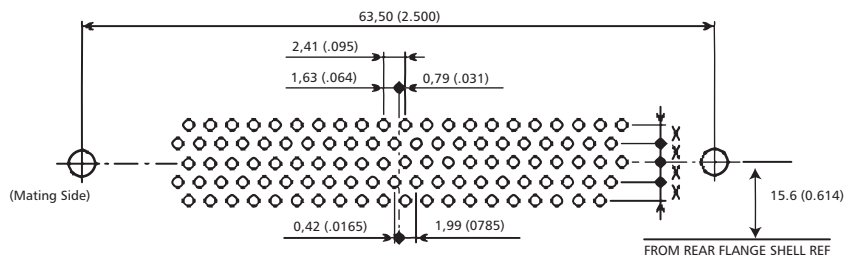

Dimension X  
1,98 (.078) for sizes E, A, B, C  
2,08 (.082) for size D

Recommended PC hole for signal contacts  
? 0,90 (.035) min for terminations ? 0,51 (.020)  
? 1,00 (.040) min for terminations ? 0,57 (.022)

Recommended PCB mounting hole  
? 3.05 (.120)

Standard Panel Cutouts

Panel Cutouts

Standard Cutout

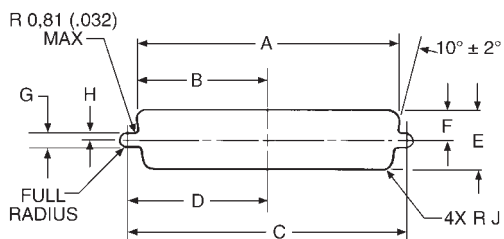

Rear Mounting Cutout (Optional)

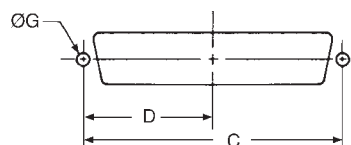

Front Panel Mounting

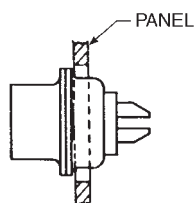

Standard Shell

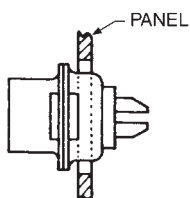

Dual Float Mount Shell

Rear Panel Mounting

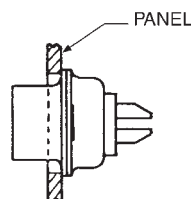

Standard Shell

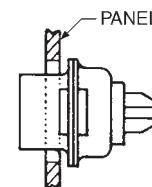

Dual Float Mount Shell

Standard Shell

Shell Size	Mounting Method	A ± 0,13 (.005)	B ± 0,13 (.005)	C ± 0,13 (.005)	D ± 0,13 (.005)	E ± 0,13 (.005)	F ± 0,13 (.005)	G ± 0,05 (.002)	H ± 0,05 (.002)	J ± 0,05 (.002)
DE	Front	22,19 (.874)	11,09 (.437)	24,99 (.984)	12,49 (.492)	13,03 (.513)	6,52 (.257)	3,04 (.120)	1,52 (.060)	2,10 (.083)
	Rear	20,47 (.806)	10,23 (.403)	24,99 (.984)	12,49 (.492)	11,40 (.449)	5,71 (.225)	3,04 (.120)	1,52 (.060)	3,35 (.132)
DA	Front	30,53 (1.202)	15,26 (.601)	33,32 (1.312)	16,66 (.656)	13,03 (.513)	6,52 (.257)	3,04 (.120)	1,52 (.060)	2,10 (.083)
	Rear	28,80 (1.134)	14,40 (.567)	33,32 (1.312)	16,66 (.656)	11,40 (.449)	5,71 (.225)	3,04 (.120)	1,52 (.060)	3,35 (.132)
DB	Front	44,27 (1.743)	22,14 (.872)	47,04 (1.852)	23,52 (.926)	13,03 (.513)	6,52 (.257)	3,04 (.120)	1,52 (.060)	2,10 (.083)
	Rear	42,51 (1.674)	21,25 (.837)	47,04 (1.852)	23,52 (.926)	11,40 (.449)	5,71 (.225)	3,04 (.120)	1,52 (.060)	3,35 (.132)
DC	Front	60,73 (2.391)	30,37 (1.196)	63,50 (2.500)	31,75 (1.250)	13,03 (.513)	6,52 (.257)	3,04 (.120)	1,52 (.060)	2,10 (.083)
	Rear	59,08 (2.326)	29,54 (1.163)	63,50 (2.500)	31,75 (1.250)	11,40 (.449)	5,71 (.225)	3,04 (.120)	1,52 (.060)	3,35 (.132)
DD	Front	58,34 (2.297)	29,18 (1.149)	61,11 (2.406)	30,55 (1.203)	15,82 (.623)	7,92 (.312)	3,04 (.120)	1,52 (.060)	2,10 (.083)
	Rear	56,33 (2.218)	28,16 (1.109)	61,11 (2.406)	30,55 (1.203)	14,09 (.555)	7,06 (.278)	3,04 (.120)	1,52 (.060)	3,35 (.132)

Dual Float Mount Shell

Shell Size	Mounting Method	A ± 0,13 (.005)	B ± 0,13 (.005)	C ± 0,13 (.005)	D ± 0,13 (.005)	E ± 0,13 (.005)	F ± 0,13 (.005)	G ± 0,05 (.002)	H ± 0,05 (.002)	J ± 0,05 (.002)
DE	Front	23,01 (.906)	11,50 (.453)	24,99 (.984)	12,49 (.492)	13,84 (.545)	6,93 (.273)	2,23 (.088)	1,11 (.044)	2,10 (.083)
	Rear	21,28 (.838)	10,64 (.419)	24,99 (.984)	12,49 (.492)	12,21 (.481)	6,12 (.241)	2,23 (.088)	1,11 (.044)	3,35 (.132)
DA	Front	31,34 (1.234)	15,67 (.617)	33,32 (1.312)	16,66 (.656)	13,84 (.545)	6,93 (.273)	2,23 (.088)	1,11 (.044)	2,10 (.083)
	Rear	29,61 (1.166)	14,80 (.583)	33,32 (1.312)	16,66 (.656)	12,21 (.481)	6,12 (.241)	2,23 (.088)	1,11 (.044)	3,35 (.132)
DB	Front	45,08 (1.775)	22,55 (.888)	47,04 (1.852)	23,52 (.926)	13,84 (.545)	6,93 (.273)	2,23 (.088)	1,11 (.044)	2,10 (.083)
	Rear	43,33 (1.706)	21,66 (.853)	47,04 (1.852)	23,52 (.926)	12,21 (.481)	6,12 (.241)	2,23 (.088)	1,11 (.044)	3,35 (.132)
DC	Front	61,54 (2.423)	30,78 (1.212)	63,50 (2.500)	31,75 (1.250)	13,84 (.545)	6,93 (.273)	2,23 (.088)	1,11 (.044)	2,10 (.083)
	Rear	59,79 (2.354)	29,89 (1.177)	63,50 (2.500)	31,75 (1.250)	12,21 (.481)	6,12 (.241)	2,23 (.088)	1,11 (.044)	3,35 (.132)
DD	Front	59,15 (2.329)	29,59 (1.165)	61,11 (2.406)	30,55 (1.203)	16,63 (.655)	8,33 (.328)	2,23 (.088)	1,11 (.044)	2,10 (.083)
	Rear	57,15 (2.250)	28,57 (1.125)	61,11 (2.406)	30,55 (1.203)	14,90 (.587)	7,46 (.294)	2,23 (.088)	1,11 (.044)	3,35 (.132)

Dimensions shown in inches (mm)  
Specifications and dimensions subject to change



# M24308 Cross Reference

Gov't Designation	ITT Part Number
M24308/1-1Z	DEMM9S
M24308/1-1F	DEMM9S-A101
M24308/1-2Z	DAMM15S
M24308/1-2F	DAMM15S-A101
M24308/1-3Z	DBMM25S
M24308/1-3F	DBMM25S-A101
M24308/1-4Z	DCMM37S
M24308/1-4F	DCMM37S-A101
M24308/1-5Z	DDMM50S
M24308/1-5F	DDMM50S-A101
M24308/1-12Z	DEMMY9S
M24308/1-12F	DEMMY9S-A101
M24308/1-13Z	DAMMY15S
M24308/1-13F	DAMMY15S-A101
M24308/1-14Z	DBMMY25S
M24308/1-14F	DBMMY25S-A101
M24308/1-15Z	DCMMY37S
M24308/1-15F	DCMMY37S-A101
M24308/1-16Z	DDMMY50S
M24308/1-16F	DDMMY50S-A101
M24308/1-23Z	DEMMY9S
M24308/1-23F	DEMMY9S-A101
M24308/1-24Z	DAMMY15S
M24308/1-24F	DAMMY15S-A101
M24308/1-25Z	DBMMY25S
M24308/1-25F	DBMMY25S-A101
M24308/1-26Z	DCMMY37S
M24308/1-26F	DCMMY37S-A101
M24308/1-27Z	DDMMY50S
M24308/1-27F	DDMMY50S-A101
M24308/2-1Z	DEMAM9S
M24308/2-1F	DEMAM9S-A101
M24308/2-2Z	DAMAM15S
M24308/2-2F	DAMAM15S-A101
M24308/2-3Z	DCMAM25S
M24308/2-3F	DCMAM25S-A101
M24308/2-4Z	DCMAM37S
M24308/2-4F	DCMAM37S-A101
M24308/2-5Z	DDMAM50S
M24308/2-5F	DDMAM50S-A101
M24308/2-6Z	DEMAMT9S
M24308/2-6F	DEMAMT9S-A101
M24308/2-7Z	DAMAMT15S
M24308/2-7F	DAMAMT15S-A101
M24308/2-8Z	DBMAMT25S
M24308/2-8F	DBMAMT25S-A101
M24308/2-9Z	DCMAMT37S
M24308/2-9F	DCMAMT37S-A101
M24308/2-10Z	DDMAMT50S
M24308/2-10F	DDMAMT50S-A101
M24308/2-11Z	DEMAM15S
M24308/2-11F	DEMAM15S-A101
M24308/2-12Z	DAMAM26S
M24308/2-12F	DAMAM26S-A101
M24308/2-13Z	DBMAM44S
M24308/2-13F	DBMAM44S-A101
M24308/2-14Z	DCMAM62S
M24308/2-14F	DCMAM62S-A101

Gov't Designation	ITT Part Number
M24308/2-15Z	DDMAM78S
M24308/2-15F	DDMAM78S-A101
M24308/2-17Z	DEMAMT15S
M24308/2-17F	DEMAMT15S-A101
M24308/2-18Z	DAMAMT26S
M24308/2-18F	DAMAMT26S-A101
M24308/2-19Z	DBMAMT44S
M24308/2-19F	DBMAMT44S-A101
M24308/2-20Z	DCMAMT62S
M24308/2-20F	DCMAMT62S-A101
M24308/2-21Z	DDMAMT78S
M24308/2-21F	DDMAMT78S-A101
M24308/2-23Z	DEMAMY9S
M24308/2-23F	DEMAMY9S-A101
M24308/2-24Z	DAMAMY15S
M24308/2-24F	DAMAMY15S-A101
M24308/2-25Z	DBMAMY25S
M24308/2-25F	DBMAMY25S-A101
M24308/2-26Z	DCMAMY37S
M24308/2-26F	DCMAMY37S-A101
M24308/2-27Z	DDMAMY50S
M24308/2-27F	DDMAMY50S-A101
M24308/2-28Z	DEMAMY15S
M24308/2-28F	DEMAMY15S-A101
M24308/2-29Z	DAMAMY26S
M24308/2-29F	DAMAMY26S-A101
M24308/2-30Z	DBMAMY44S
M24308/2-30F	DBMAMY44S-A101
M24308/2-31Z	DCMAMY62S
M24308/2-31F	DCMAMY62S-A101
M24308/2-32Z	DDMAMY78S
M24308/2-32F	DDMAMY78S-A101
M24308/2-34Z	DEMAMYT9S
M24308/2-34F	DEMAMYT9S-A101
M24308/2-35Z	DAMAMYT15S
M24308/2-35F	DAMAMYT15S-A101
M24308/2-36Z	DBMAMYT25S
M24308/2-36F	DBMAMYT25S-A101
M24308/2-37Z	DCMAMYT37S
M24308/2-37F	DCMAMYT37S-A101
M24308/2-38Z	DDMAMYT50S
M24308/2-38F	DDMAMYT50S-A101
M24308/2-39Z	DEMAMYT15S
M24308/2-39F	DEMAMYT15S-A101
M24308/2-40Z	DAMAMYT26S
M24308/2-40F	DAMAMYT26S-A101
M24308/2-41Z	DBMAMYT44S
M24308/2-41F	DBMAMYT44S-A101
M24308/2-42Z	DCMAMYT62S
M24308/2-42F	DCMAMYT62S-A101
M24308/2-43Z	DDMAMYT78S
M24308/2-43F	DDMAMYT78S-A101
M24308/2-281Z	DEMAM9S-FO
M24308/2-281F	DEMAM9S-A101-FO
M24308/2-282Z	DAMAM15S-FO
M24308/2-282F	DAMAM15S-A101-FO
M24308/2-283Z	DBMAM25S-FO
M24308/2-283F	DBMAM25S-A101-FO

Gov't Designation	ITT Part Number
M24308/2-284Z	DCMAM37S-FO
M24308/2-284F	DCMAM37S-A101-FO
M24308/2-285Z	DDMAM50S-FO
M24308/2-285F	DDMAM50S-A101-FO
M24308/2-286Z	DEMAM15S-FO
M24308/2-286F	DEMAM15S-A101-FO
M24308/2-287Z	DAMAM26S-FO
M24308/2-287F	DAMAM26S-A101-FO
M24308/2-288Z	DBMAM44S-FO
M24308/2-288F	DBMAM44S-A101-FO
M24308/2-289Z	DCMAM62S-FO
M24308/2-289F	DCMAM62S-A101-FO
M24308/2-290Z	DDMAM78S-FO
M24308/2-290F	DDMAM78S-A101-FO
M24308/2-292Z	DEMAMY9S-FO
M24308/2-292F	DEMAMY9S-A101-FO
M24308/2-293Z	DAMAMY15S-FO
M24308/2-293F	DAMAMY15S-A101-FO
M24308/2-294Z	DBMAMY25S-FO
M24308/2-294F	DBMAMY25S-A101-FO
M24308/2-295Z	DCMAMY37S-FO
M24308/2-295F	DCMAMY37S-A101-FO
M24308/2-296Z	DDMAMY50S-FO
M24308/2-296F	DDMAMY50S-A101-FO
M24308/2-297Z	DEMAMY15S-FO
M24308/2-297F	DEMAMY15S-A101-FO
M24308/2-298Z	DAMAMY26S-FO
M24308/2-298F	DAMAMY26S-A101-FO
M24308/2-299Z	DBMAMY44S-FO
M24308/2-299F	DBMAMY44S-A101-FO
M24308/2-300Z	DCMAMY62S-FO
M24308/2-300F	DCMAMY62S-A101-FO
M24308/2-301Z	DDMAMY78S-FO
M24308/2-301F	DDMAMY78S-A101-FO
M24308/2-335Z	DBMAMY25S
M24308/2-335F	DBMAMY25S-A101
M24308/2-336Z	DCMAMY37S
M24308/2-336F	DCMAMY37S-A101
M24308/2-341Z	DAMAMY15S
M24308/2-341F	DAMAMY15S-A101
M24308/2-342Z	DEMAMY9S
M24308/2-342F	DEMAMY9S-A101
M24308/2-343Z	DAMAMY15S
M24308/2-343F	DAMAMY15S-A101
M24308/2-344Z	DBMAMY25S
M24308/2-344F	DBMAMY25S-A101
M24308/2-345Z	DCMAMY37S
M24308/2-345F	DCMAMY37S-A101
M24308/2-346Z	DDMAMY50S
M24308/2-346F	DDMAMY50S-A101
M24308/2-347Z	DEMAMY15S
M24308/2-347F	DEMAMY15S-A101
M24308/2-348Z	DAMAMY26S
M24308/2-348F	DAMAMY26S-A101
M24308/2-349Z	DBMAMY44S
M24308/2-349F	DBMAMY44S-A101
M24308/2-350Z	DCMAMY62S
M24308/2-350F	DCMAMY62S-A101

D Sub



Dimensions shown in inches (mm)  
Specifications and dimensions subject to change

www.ittcannon.com

Gov't Designation	ITT Part Number
M24308/2-351Z	DDMAMY78S
M24308/2-351F	DDMAMY78S-A101
M24308/2-353Z	DEMAMYT9S
M24308/2-353F	DEMAMYT9S-A101
M24308/2-354Z	DAMAMYT15S
M24308/2-354F	DAMAMYT15S-A101
M24308/2-355Z	DBMAMYT25S
M24308/2-355F	DBMAMYT25S-A101
M24308/2-356Z	DCMAMYT37S
M24308/2-356F	DCMAMYT37S-A101
M24308/2-357Z	DDMAMYT50S
M24308/2-357F	DDMAMYT50S-A101
M24308/2-358Z	DEMAMYT15S
M24308/2-358F	DEMAMYT15S-A101
M24308/2-359Z	DAMAMYT26S
M24308/2-359F	DAMAMYT26S-A101
M24308/2-360Z	DBMAMYT44S
M24308/2-360F	DBMAMYT44S-A101
M24308/2-361Z	DCMAMYT62S
M24308/2-361F	DCMAMYT62S-A101
M24308/2-362Z	DDMAMYT78S
M24308/2-362F	DDMAMYT78S-A101
M24308/2-482Z	DEMAMY9S-FO
M24308/2-482F	DEMAMY9S-A101-FO
M24308/2-483Z	DAMAMY15-S-FO
M24308/2-483F	DAMAMY15-S-A101-FO
M24308/2-484Z	DBMAMY25S-FO
M24308/2-484F	DBMAMY25S-A101-FO
M24308/2-485Z	DCMAMY37S-FO
M24308/2-485F	DCMAMY37S-A101-FO
M24308/2-486Z	DDMAMY50S-FO
M24308/2-486F	DDMAMY50S-A101-FO
M24308/2-487Z	DEMAMY15S-FO
M24308/2-487F	DEMAMY15S-A101-FO
M24308/2-488Z	DAMAMY26S-FO
M24308/2-488F	DAMAMY26S-A101-FO
M24308/2-489Z	DBMAMY44S-FO
M24308/2-489F	DBMAMY44S-A101-FO
M24308/2-490Z	DCMAMY62S-FO
M24308/2-490F	DCMAMY62S-A101-FO
M24308/2-491Z	DDMAMY78S-FO
M24308/2-491F	DDMAMY78S-A101-FO
M24308/2-509Z	DBMAMY25S
M24308/2-509F	DBMAMY25S-A101
M24308/2-510Z	DCMAMY37S
M24308/2-510F	DCMAMY37S-A101
M24308/2-515Z	DAMAMY15S
M24308/2-515F	DAMAMY15S-A101
M24308/3-1Z	DEMAM9P
M24308/3-1F	DEMAM9P-A101
M24308/3-2Z	DAMM15P
M24308/3-2F	DAMM15P-A101
M24308/3-3Z	DBMM25P
M24308/3-3F	DBMM25P-A101
M24308/3-4Z	DCMM37P
M24308/3-4F	DCMM37P-A101
M24308/3-5Z	DDMM50P
M24308/3-5F	DDMM50P-A101

Gov't Designation	ITT Part Number
M24308/3-12Z	DEMMY-9P
M24308/3-12F	DEMMY-9P-A101
M24308/3-13Z	DAMMY-15P
M24308/3-13F	DAMMY-15P-A101
M24308/3-14Z	DBMMY-25P
M24308/3-14F	DBMMY-25P-A101
M24308/3-15Z	DCMMY-37P
M24308/3-15F	DCMMY-37P-A101
M24308/3-16Z	DDMMY-50P
M24308/3-16F	DDMMY-50P-A101
M24308/3-17Z	DEMMY-9P
M24308/3-17F	DEMMY-9P-A101
M24308/3-18Z	DAMMY-15P
M24308/3-18F	DAMMY-15P-A101
M24308/3-19Z	DBMMY-25P
M24308/3-19F	DBMMY-25P-A101
M24308/3-20Z	DCMMY-37P
M24308/3-20F	DCMMY-37P-A101
M24308/3-21Z	DDMMY-50P
M24308/3-21F	DDMMY-50P-A101
M24308/4-1Z	DEMAM9P
M24308/4-1F	DEMAM9P-A101
M24308/4-2Z	DAMAM15P
M24308/4-2F	DAMAM15P-A101
M24308/4-3Z	DBMAM25P
M24308/4-3F	DBMAM25P-A101
M24308/4-4Z	DCMAM37P
M24308/4-4F	DCMAM37P-A101
M24308/4-5Z	DDMAM50P
M24308/4-5F	DDMAM50P-A101
M24308/4-6Z	DEMAMT9P
M24308/4-6F	DEMAMT9P-A101
M24308/4-7Z	DAMAMT15P
M24308/4-7F	DAMAMT15P-A101
M24308/4-8Z	DBMAMT25P
M24308/4-8F	DBMAMT25P-A101
M24308/4-9Z	DCMAMT37P
M24308/4-9F	DCMAMT37P-A101
M24308/4-10Z	DDMAMT50P
M24308/4-10F	DDMAMT50P-A101
M24308/4-11Z	DEMAM15P
M24308/4-11F	DEMAM15P-A101
M24308/4-12Z	DAMAM26P
M24308/4-12F	DAMAM26P-A101
M24308/4-13Z	DBMAM44P
M24308/4-13F	DBMAM44P-A101
M24308/4-14Z	DCMAM62P
M24308/4-14F	DCMAM62P-A101
M24308/4-15Z	DDMAM78P
M24308/4-15F	DDMAM78P-A101
M24308/4-17Z	DEMAMT15P
M24308/4-17F	DEMAMT15P-A101
M24308/4-18Z	DAMAMT26P
M24308/4-18F	DAMAMT26P-A101
M24308/4-19Z	DBMAMT44P
M24308/4-19F	DBMAMT44P-A101
M24308/4-20Z	DCMAMT62P
M24308/4-20F	DCMAMT62P-A101

Gov't Designation	ITT Part Number
M24308/4-21Z	DDMAMT78P
M24308/4-21F	DDMAMT78P-A101
M24308/4-259Z	DEMAM9P-FO
M24308/4-259F	DEMAM9P-A101-FO
M24308/4-260Z	DAMAM15P-FO
M24308/4-260F	DAMAM15P-A101-FO
M24308/4-261Z	DBMAM25P-FO
M24308/4-261F	DBMAM25P-A101-FO
M24308/4-262Z	DCMAM37P-FO
M24308/4-262F	DCMAM37P-A101-FO
M24308/4-263Z	DDMAM50P-FO
M24308/4-263F	DDMAM50P-A101-FO
M24308/4-264Z	DEMAM15P-FO
M24308/4-264F	DEMAM15P-A101-FO
M24308/4-265Z	DAMAM26P-FO
M24308/4-265F	DAMAM26P-A101-FO
M24308/4-266Z	DBMAM44P-FO
M24308/4-266F	DBMAM44P-A101-FO
M24308/4-267Z	DCMAM62P-FO
M24308/4-267F	DCMAM62P-A101-FO
M24308/4-268Z	DDMAM78P-FO
M24308/4-268F	DDMAM78P-A101-FO
M24308/4-302Z	DEMAMY9P
M24308/4-302F	DEMAMY9P-A101
M24308/4-303Z	DAMAMY15P
M24308/4-303F	DAMAMY15P-A101
M24308/4-304Z	DBMAMY25P
M24308/4-304F	DBMAMY25P-A101
M24308/4-305Z	DCMAMY37P
M24308/4-305F	DCMAMY37P-A101
M24308/4-306Z	DDMAMY50P
M24308/4-306F	DDMAMY50P-A101
M24308/4-307Z	DEMAMY15P
M24308/4-307F	DEMAMY15P-A101
M24308/4-308Z	DAMAMY26P
M24308/4-308F	DAMAMY26P-A101
M24308/4-309Z	DBMAMY44P
M24308/4-309F	DBMAMY44P-A101
M24308/4-310Z	DCMAMY62P
M24308/4-310F	DCMAMY62P-A101
M24308/4-311Z	DDMAMY78P
M24308/4-311F	DDMAMY78P-A101
M24308/4-313Z	DEMAMYT9P
M24308/4-313F	DEMAMYT9P-A101
M24308/4-314Z	DAMAMYT15P
M24308/4-314F	DAMAMYT15P-A101
M24308/4-315Z	DBMAMYT25P
M24308/4-315F	DBMAMYT25P-A101
M24308/4-316Z	DCMAMYT37P
M24308/4-316F	DCMAMYT37P-A101
M24308/4-317Z	DDMAMYT50P
M24308/4-317F	DDMAMYT50P-A101
M24308/4-318Z	DEMAMYT15P
M24308/4-318F	DEMAMYT15P-A101
M24308/4-319Z	DAMAMYT26P
M24308/4-319F	DAMAMYT26P-A101
M24308/4-320Z	DBMAMYT44P
M24308/4-320F	DBMAMYT44P-A101

Dimensions shown in inches (mm)  
 Specifications and dimensions subject to change



# M24308 Cross Reference

Gov't Designation	ITT Part Number
M24308/4-321Z	DCMAMYT62P
M24308/4-321F	DCMAMYT62P-A101
M24308/4-322Z	DDMAMYT78P
M24308/4-322F	DDMAMYT78P-A101
M24308/4-324Z	DEMAMY9PFO
M24308/4-324F	DEMAMY9P-A101-FO
M24308/4-325Z	DAMAMY15PFO
M24308/4-325F	DAMAMY15P-A101-FO
M24308/4-326Z	DBMAMY25PFO
M24308/4-326F	DBMAMY25P-A101-FO
M24308/4-327Z	DCMAMY37PFO
M24308/4-327F	DCMAMY37P-A101-FO
M24308/4-328Z	DDMAMY50PFO
M24308/4-328F	DDMAMY50P-A101-FO
M24308/4-329Z	DEMAMY15P-FO
M24308/4-329F	DEMAMY15P-A101-FO
M24308/4-330Z	DAMAMY26P-FO
M24308/4-330F	DAMAMY26P-A101-FO
M24308/4-331Z	DBMAMY44P-FO
M24308/4-331F	DBMAMY44P-A101-FO
M24308/4-332Z	DCMAMY62P-FO
M24308/4-332F	DCMAMY62P-A101-FO
M24308/4-333Z	DDMAMY78P-FO
M24308/4-333F	DDMAMY78P-A101-FO
M24308/4-435Z	DEMAMY9P
M24308/4-435F	DEMAMY9P-A101
M24308/4-436Z	DAMAMY15P
M24308/4-436F	DAMAMY15P-A101
M24308/4-437Z	DBMAMY25P
M24308/4-437F	DBMAMY25P-A101
M24308/4-438Z	DCMAMY37P
M24308/4-438F	DCMAMY37P-A101
M24308/4-439Z	DDMAMY50P
M24308/4-439F	DDMAMY50P-A101
M24308/4-440Z	DEMAMY15P
M24308/4-440F	DEMAMY15P-A101
M24308/4-441Z	DAMAMY26P
M24308/4-441F	DAMAMY26P-A101
M24308/4-442Z	DBMAMY44P
M24308/4-442F	DBMAMY44P-A101
M24308/4-443Z	DCMAMY62P
M24308/4-443F	DCMAMY62P-A101
M24308/4-444Z	DDMAMY78P
M24308/4-444F	DDMAMY78P-A101
M24308/4-446Z	DEMAMY9P
M24308/4-446F	DEMAMY9P-A101
M24308/4-447Z	DAMAMY15P
M24308/4-447F	DAMAMY15P-A101
M24308/4-448Z	DBMAMY25P
M24308/4-448F	DBMAMY25P-A101
M24308/4-449Z	DCMAMY37P
M24308/4-449F	DCMAMY37P-A101
M24308/4-450Z	DDMAMY50P
M24308/4-450F	DDMAMY50P-A101
M24308/4-451Z	DEMAMY15P
M24308/4-451F	DEMAMY15P-A101
M24308/4-452Z	DAMAMY26P
M24308/4-452F	DAMAMY26P-A101

Gov't Designation	ITT Part Number
M24308/4-452F	DAMAMYT26P-A101
M24308/4-453Z	DBMAMY44P
M24308/4-453F	DBMAMY44P-A101
M24308/4-454Z	DCMAMY62P
M24308/4-454F	DCMAMY62P-A101
M24308/4-455Z	DDMAMYT78P
M24308/4-455F	DDMAMYT78P-A101
M24308/4-457Z	DEMAMY9P-FO
M24308/4-457F	DEMAMY9P-A101-FO
M24308/4-458Z	DAMAMY15P-FO
M24308/4-458F	DAMAMY15P-A101-FO
M24308/4-459Z	DBMAMY25P-FO
M24308/4-459F	DBMAMY25P-A101-FO
M24308/4-460Z	DCMAMY37P-FO
M24308/4-460F	DCMAMY37P-A101-FO
M24308/4-461Z	DDMAMY50P-FO
M24308/4-461F	DDMAMY50P-A101-FO
M24308/4-462Z	DEMAMY15P-FO
M24308/4-462F	DEMAMY15P-A101-FO
M24308/4-463Z	DAMAMY26P-FO
M24308/4-463F	DAMAMY26P-A101-FO
M24308/4-464Z	DBMAMY44P-FO
M24308/4-464F	DBMAMY44P-A101-FO
M24308/4-465Z	DCMAMY62P-FO
M24308/4-465F	DCMAMY62P-A101-FO
M24308/4-466Z	DDMAMY78P-FO
M24308/4-466F	DDMAMY78P-A101-FO
M24308/5-1Z	DEMAM9SNM
M24308/5-1F	DEMAM9SNM-A101
M24308/5-1P	DEMAM9SNM-F225
M24308/5-2Z	DAMM15SNM
M24308/5-2F	DAMM15SNM-A101
M24308/5-2P	DAMM15SNM-F225
M24308/5-3Z	DBMM25SNM
M24308/5-3F	DBMM25SNM-A101
M24308/5-3P	DBMM25SNM-F225
M24308/5-4Z	DCMM37SNM
M24308/5-4F	DCMM37SNM-A101
M24308/5-4P	DCMM37SNM-F225
M24308/5-5Z	DDMM50SNM
M24308/5-5F	DDMM50SNM-A101
M24308/5-5P	DDMM50SNM-F225
M24308/5-12Z	DEMMY9SNM
M24308/5-12F	DEMMY9SNM-A101
M24308/5-13Z	DAMMY15SNM
M24308/5-13F	DAMMY15SNM-A101
M24308/5-14Z	DBMMY25SNM
M24308/5-14F	DBMMY25SNM-A101
M24308/5-15Z	DCMMY37SNM
M24308/5-15F	DCMMY37SNM-A101
M24308/5-16Z	DDMMY50SNM
M24308/5-16F	DDMMY50SNM-A101
M24308/5-23Z	DEMMY9SNM
M24308/5-23F	DEMMY9SNM-A101
M24308/5-24Z	DAMMY15SNM
M24308/5-24F	DAMMY15SNM-A101
M24308/5-25Z	DBMMY25SNM
M24308/5-25F	DBMMY25SNM-A101
M24308/5-26Z	DCMMY37SNM

Gov't Designation	ITT Part Number
M24308/5-26F	DCMMY37SNM-A101
M24308/5-27Z	DDMMY50SNM
M24308/5-27F	DDMMY50SNM-A101
M24308/5-34	DEMAM9SNMBK52
M24308/5-35	DAMM15SNMBK52
M24308/5-36	DBMM25SNMBK52
M24308/5-37	DCMM37SNMBK52
M24308/5-38	DDMM50SNMBK52
M24308/5-45	DEMMY9SNMBK52
M24308/5-46	DAMMY15SNMBK52
M24308/5-47	DBMMY25SNMBK52
M24308/5-48	DCMMY37SNMBK52
M24308/5-49	DDMMY50SNMBK52
M24308/5-56	DEMMY9SNMBK52
M24308/5-57	DAMMY15SNMBK52
M24308/5-58	DBMMY25SNMBK52
M24308/5-59	DCMMY37SNMBK52
M24308/5-60	DDMMY50SNMBK52
M24308/6-1Z	DEMAM9SNM
M24308/6-1F	DEMAM9SNM-A101
M24308/6-1P	DEMAM9SNM-F225
M24308/6-2Z	DAMAM15SNM
M24308/6-2F	DAMAM15SNM-A101
M24308/6-2P	DAMAM15SNM-F225
M24308/6-3Z	DBMAM25SNM
M24308/6-3F	DBMAM25SNM-A101
M24308/6-3P	DBMAM25SNM-F225
M24308/6-4Z	DCMAM37SNM
M24308/6-4F	DCMAM37SNM-A101
M24308/6-4P	DCMAM37SNM-F225
M24308/6-5Z	DDMAM50SNM
M24308/6-5F	DDMAM50SNM-A101
M24308/6-5P	DDMAM50SNM-F225
M24308/6-6Z	DEMAMT9SNM
M24308/6-6F	DEMAMT9SNM-A101
M24308/6-6P	DEMAMT9SNM-F225
M24308/6-7Z	DAMAMT15SNM
M24308/6-7F	DAMAMT15SNM-A101
M24308/6-7P	DAMAMT15SNM-F225
M24308/6-8Z	DBMAMT25SNM
M24308/6-8F	DBMAMT25SNM-A101
M24308/6-8P	DBMAMT25SNM-F225
M24308/6-9Z	DCMAMT37SNM
M24308/6-9F	DCMAMT37SNM-A101
M24308/6-9P	DCMAMT37SNM-F225
M24308/6-10Z	DDMAMT50SNM
M24308/6-10F	DDMAMT50SNM-A101
M24308/6-10P	DDMAMT50SNM-F225
M24308/6-11Z	DEMAM15SNM
M24308/6-11F	DEMAM15SNM-A101
M24308/6-11P	DEMAM15SNM-F225
M24308/6-12Z	DAMAM26SNM
M24308/6-12F	DAMAM26SNM-A101
M24308/6-12P	DAMAM26SNM-F225
M24308/6-13Z	DBMAM44SNM
M24308/6-13F	DBMAM44SNM-A101
M24308/6-13P	DBMAM44SNM-F225
M24308/6-14Z	DCMAM62SNM

D Sub



Dimensions shown in inches (mm)  
Specifications and dimensions subject to change



Gov't Designation	ITT Part Number
M24308/6-14F	DCMAM62SNM-A101
M24308/6-14P	DCMAM62SNM-F225
M24308/6-15Z	DDMAM78SNM
M24308/6-15F	DDMAM78SNM-A101
M24308/6-15P	DDMAM78SNM-F225
M24308/6-17Z	DEMAMT15SNM
M24308/6-17F	DEMAMT15SNM-A101
M24308/6-17P	DEMAMT15SNM-F225
M24308/6-18Z	DAMAMT26SNM
M24308/6-18F	DAMAMT26SNM-A101
M24308/6-18P	DAMAMT26SNM-F225
M24308/6-19Z	DBMAMT44SNM
M24308/6-19F	DBMAMT44SNM-A101
M24308/6-19P	DBMAMT44SNM-F225
M24308/6-20Z	DCMAMT62SNM
M24308/6-20F	DCMAMT62SNM-A101
M24308/6-20P	DCMAMT62SNM-F225
M24308/6-21Z	DDMAMT78SNM
M24308/6-21F	DDMAMT78SNM-A101
M24308/6-21P	DDMAMT78SNM-F225
M24308/6-259Z	DEMAMY9SNM
M24308/6-259F	DEMAMY9SNM-A101
M24308/6-260Z	DAMAMY15SNM
M24308/6-260F	DAMAMY15SNM-A101
M24308/6-261Z	DBMAMY25SNM
M24308/6-261F	DBMAMY25SNM-A101
M24308/6-262Z	DCMAMY37SNM
M24308/6-262F	DCMAMY37SNM-A101
M24308/6-263Z	DDMAMY50SNM
M24308/6-263F	DDMAMY50SNM-A101
M24308/6-264Z	DEMAMY15SNM
M24308/6-264F	DEMAMY15SNM-A101
M24308/6-265Z	DAMAMY26SNM
M24308/6-265F	DAMAMY26SNM-A101
M24308/6-266Z	DBMAMY44SNM
M24308/6-266F	DCMAMY44SNM-A101
M24308/6-267Z	DCMAMY62SNM
M24308/6-267F	DCMAMY62SNM-A101
M24308/6-268Z	DDMAMY78SNM
M24308/6-268F	DDMAMY78SNM-A101
M24308/6-270Z	DEMAMYT9SNM
M24308/6-270F	DEMAMYT9SNM-A101
M24308/6-271Z	DAMAMYT15SNM
M24308/6-271F	DAMAMYT15SNM-A101
M24308/6-272Z	DBMAMYT25SNM
M24308/6-272F	DBMAMYT25SNM-A101
M24308/6-273Z	DCMAMYT37SNM
M24308/6-273F	DCMAMYT37SNM-A101
M24308/6-274Z	DDMAMYT50SNM
M24308/6-274F	DDMAMYT50SNM-A101
M24308/6-275Z	DEMAMYT15SNM
M24308/6-275F	DEMAMYT15SNM-A101
M24308/6-276Z	DAMAMYT26SNM
M24308/6-276F	DAMAMYT26SNM-A101
M24308/6-277Z	DBMAMYT44SNM
M24308/6-277F	DCMAMYT44SNM-A101
M24308/6-278Z	DCMAMY62SNM
M24308/6-278F	DCMAMY62SNM-A101

Gov't Designation	ITT Part Number
M24308/6-279Z	DDMAMYT78SNM
M24308/6-279F	DDMAMYT78SNM-A101
M24308/6-281Z	DEMAM9SNM-FO
M24308/6-281F	DEMAM9SNM-A101-FO
M24308/6-281P	DEMAM9SNM-F225-FO
M24308/6-282Z	DAMAM15SNM-FO
M24308/6-282F	DAMAM15SNM-A101-FO
M24308/6-282P	DAMAM15SNM-F225-FO
M24308/6-283Z	DBMAM25SNM-FO
M24308/6-283F	DBMAM25SNM-A101-FO
M24308/6-283P	DBMAM25SNM-F225-FO
M24308/6-284Z	DCMAM37SNM-FO
M24308/6-284F	DCMAM37SNM-A101-FO
M24308/6-284P	DCMAM37SNM-F225-FO
M24308/6-285Z	DDMAM50SNM-FO
M24308/6-285F	DDMAM50SNM-A101-FO
M24308/6-285P	DDMAM50SNM-F225-FO
M24308/6-286Z	DEMAM15SNM-FO
M24308/6-286F	DEMAM15SNM-A101-FO
M24308/6-286P	DEMAM15SNM-F225-FO
M24308/6-287Z	DAMAM26SNM-FO
M24308/6-287F	DAMAM26SNM-A101-FO
M24308/6-287P	DAMAM26SNM-F225-FO
M24308/6-288Z	DBMAM44SNM-FO
M24308/6-288F	DBMAM44SNM-A101-FO
M24308/6-288P	DBMAM44SNM-F225-FO
M24308/6-289Z	DCMAM62SNM-FO
M24308/6-289F	DCMAM62SNM-A101-FO
M24308/6-289P	DCMAM62SNM-F225-FO
M24308/6-290Z	DDMAM78SNM-FO
M24308/6-290F	DDMAM78SNM-A101-FO
M24308/6-290P	DDMAM78SNM-F225-FO
M24308/6-324	DEMAMY9SNM-FO
M24308/6-324F	DEMAMY9SNM-A101-FO
M24308/6-325	DAMAMY15SNM-FO
M24308/6-325F	DAMAMY15SNM-A101-FO
M24308/6-326	DBMAMY25SNM-FO
M24308/6-326F	DBMAMY25SNM-A101-FO
M24308/6-327	DCMAMY37SNM-FO
M24308/6-327F	DCMAMY37SNM-A101-FO
M24308/6-328	DDMAMY50SNM-FO
M24308/6-328F	DDMAMY50SNM-A101-FO
M24308/6-453	DEMAMY9SNM
M24308/6-453F	DEMAMY9SNM-A101
M24308/6-454	DAMAMY15SNM
M24308/6-454F	DAMAMY15SNM-A101
M24308/6-455	DBMAMY25SNM
M24308/6-455F	DBMAMY25SNM-A101
M24308/6-456	DCMAMY37SNM
M24308/6-456F	DCMAMY37SNM-A101
M24308/6-457	DDMAMY50SNM
M24308/6-457F	DDMAMY50SNM-A101
M24308/6-458	DEMAMY15SNM
M24308/6-458F	DEMAMY15SNM-A101
M24308/6-459	DAMAMY26SNM
M24308/6-459F	DAMAMY26SNM-A101
M24308/6-460	DBMAMY44SNM
M24308/6-460F	DBMAMY44SNM-A101

Gov't Designation	ITT Part Number
M24308/6-461	DCMAMY62SNM
M24308/6-461F	DCMAMY62SNM-A101
M24308/6-462	DDMAMY78SNM
M24308/6-462F	DDMAMY78SNM-A101
M24308/6-464Z	DEMAMYT9SNM
M24308/6-464F	DEMAMYT9SNM-A101
M24308/6-465Z	DAMAMYT15SNM
M24308/6-465F	DAMAMYT15SNM-A101
M24308/6-466Z	DBMAMYT25SNM
M24308/6-466F	DBMAMYT25SNM-A101
M24308/6-467Z	DCMAMYT37SNM
M24308/6-467F	DCMAMYT37SNM-A101
M24308/6-468Z	DDMAMYT50SNM
M24308/6-468F	DDMAMYT50SNM-A101
M24308/6-469Z	DEMAMYT15SNM
M24308/6-469F	DEMAMYT15SNM-A101
M24308/6-470Z	DAMAMYT26SNM
M24308/6-470F	DAMAMYT26SNM-A101
M24308/6-471Z	DBMAMYT44SNM
M24308/6-471F	DBMAMYT44SNM-A101
M24308/6-472Z	DCMAMYT62SNM
M24308/6-472F	DCMAMYT62SNM-A101
M24308/6-473Z	DDMAMYT78SNM
M24308/6-473F	DDMAMYT78SNM-A101
M24308/6-491Z	DEMAMY9SNM-FO
M24308/6-491F	DEMAMY9SNM-A101-FO
M24308/6-492Z	DAMAMY15SNM-FO
M24308/6-492F	DAMAMY15SNM-A101-FO
M24308/6-493Z	DBMAMY25SNM-FO
M24308/6-493F	DBMAMY25SNM-A101-FO
M24308/6-494Z	DCMAMY37SNM-FO
M24308/6-494F	DCMAMY37SNM-A101-FO
M24308/6-495Z	DDMAMY50SNM-FO
M24308/6-495F	DDMAMY50SNM-A101-FO
M24308/6-496Z	DEMAMY15SNM-FO
M24308/6-496F	DEMAMY15SNM-A101-FO
M24308/6-497Z	DAMAMY26SNM-FO
M24308/6-497F	DAMAMY26SNM-A101-FO
M24308/6-498Z	DBMAMY44SNM-FO
M24308/6-498F	DBMAMY44SNM-A101-FO
M24308/6-499Z	DCMAMY62SNM-FO
M24308/6-499F	DCMAMY62SNM-A101-FO
M24308/6-500Z	DDMAMY78SNM-FO
M24308/6-500F	DDMAMY78SNM-A101-FO
M24308/6-502	DEMAM9SNMBK52
M24308/6-503	DAMAM15SNMBK52
M24308/6-504	DBMAM25SNMBK52
M24308/6-505	DCMAM37SNMBK52
M24308/6-506	DDMAM50SNMBK52
M24308/6-507	DEMAMT9SNMBK52
M24308/6-508	DAMAMT15SNMBK52
M24308/6-509	DBMAMT25SNMBK52
M24308/6-510	DCMAMT37SNMBK52
M24308/6-511	DDMAMT50SNMBK52
M24308/6-512	DEMAM15SNMBK52
M24308/6-513	DAMAM26SNMBK52
M24308/6-514	DBMAM44SNMBK52
M24308/6-515	DCMAM62SNMBK52

Dimensions shown in inches (mm)  
 Specifications and dimensions subject to change

www.ittcannon.com



# M24308 Cross Reference

Gov't Designation	ITT Part Number
M24308/6-516	DDMAM78SNMBK52
M24308/6-518	DEMAMT15SNMBK52
M24308/6-519	DAMAMT26SNMBK52
M24308/6-520	DBMAMT44SNMBK52
M24308/6-521	DCMAMT62SNMBK52
M24308/6-522	DDMAMT78SNMBK52
M24308/6-518	DEMAMY9SNMBK52
M24308/6-519	DAMAMY15SNMBK52
M24308/6-520	DBMAMY25SNMBK52
M24308/6-521	DCMAMY37SNMBK52
M24308/6-522	DDMAMY50SNMBK52
M24308/6-523	DEMAMY15SNMBK52
M24308/6-524	DAMAMY26SNMBK52
M24308/6-525	DBMAMY44SNMBK52
M24308/6-526	DCMAMY62SNMBK52
M24308/6-527	DDMAMY78SNMBK52
M24308/6-528	DEMAMY9SNMBK52
M24308/6-529	DAMAMY15SNMBK52
M24308/6-531	DBMAMY25SNMBK52
M24308/6-532	DCMAMY37SNMBK52
M24308/6-533	DDMAMY50SNMBK52
M24308/6-534	DEMAMY15SNMBK52
M24308/6-535	DAMAMY26SNMBK52
M24308/6-536	DBMAMY44SNMBK52
M24308/6-537	DCMAMY62SNMBK52
M24308/6-538	DDMAMY78SNMBK52
M24308/6-540	DEMAM9SNMBK52-FO
M24308/6-541	DAMAM15SNMBK52-FO
M24308/6-542	DBMAM25SNMBK52-FO
M24308/6-543	DCMAM37SNMBK52-FO
M24308/6-544	DDMAM50SNMBK52-FO
M24308/6-545	DEMAM15SNMBK52-FO
M24308/6-546	DAMAM26SNMBK52-FO
M24308/6-547	DBMAM44SNMBK52-FO
M24308/6-548	DCMAM62SNMBK52-FO
M24308/6-549	DDMAM78SNMBK52-FO
M24308/6-551	DEMAMY9SNMBK52
M24308/6-552	DAMAMY15SNMBK52
M24308/6-553	DBMAMY25SNMBK52
M24308/6-554	DCMAMY37SNMBK52
M24308/6-555	DDMAMY50SNMBK52
M24308/6-556	DEMAMY15SNMBK52
M24308/6-557	DAMAMY26SNMBK52
M24308/6-558	DBMAMY44SNMBK52
M24308/6-559	DCMAMY62SNMBK52
M24308/6-560	DDMAMY78SNMBK52
M24308/6-562	DEMAMYT9SNMBK52
M24308/6-563	DAMAMYT15SNMBK52
M24308/6-564	DBMAMYT25SNMBK52
M24308/6-565	DCMAMYT37SNMBK52
M24308/6-566	DDMAMYT50SNMBK52
M24308/6-567	DEMAMYT15SNMBK52
M24308/6-568	DAMAMYT26SNMBK52
M24308/6-569	DBMAMYT44SNMBK52
M24308/6-570	DCMAMYT62SNMBK52
M24308/6-571	DDMAMYT78SNMBK52
M24308/6-573	DEMAMY9SNMBK52-FO
M24308/6-574	DAMAMY15SNMBK52-FO

Gov't Designation	ITT Part Number
M24308/6-575	DBMAMY25SNMBK52-FO
M24308/6-576	DCMAMY37SNMBK52-FO
M24308/6-577	DDMAMY50SNMBK52-FO
M24308/6-578	DEMAMY15SNMBK52-FO
M24308/6-579	DAMAMY26SNMBK52-FO
M24308/6-580	DBMAMY44SNMBK52-FO
M24308/6-581	DCMAMY62SNMBK52-FO
M24308/6-582	DDMAMY78SNMBK52-FO
M24308/7-1Z	DEMM9PNM
M24308/7-1F	DEMM9PNM-A101
M24308/7-1P	DEMM9PNM-F225
M24308/7-2Z	DAMM15PNM
M24308/7-2F	DAMM15PNM-A101
M24308/7-2P	DAMM15PNM-F225
M24308/7-3Z	DBMM25PNM
M24308/7-3F	DBMM25PNM-A101
M24308/7-3P	DBMM25PNM-F225
M24308/7-4Z	DCMM37PNM
M24308/7-4F	DCMM37PNM-A101
M24308/7-4P	DCMM37PNM-F225
M24308/7-5Z	DDMM50PNM
M24308/7-5F	DDMM50PNM-A101
M24308/7-5P	DDMM50PNM-F225
M24308/7-12Z	DEMMY9PNM
M24308/7-12F	DEMMY9PNM-A101
M24308/7-13Z	DAMMY15PNM
M24308/7-13F	DAMMY15PNM-A101
M24308/7-14Z	DBMMY25PNM
M24308/7-14F	DBMMY25PNM-A101
M24308/7-15Z	DCMMY37PNM
M24308/7-15F	DCMMY37PNM-A101
M24308/7-16Z	DDMMY50PNM
M24308/7-16F	DDMMY50PNM-A101
M24308/7-17Z	DEMMY9PNM
M24308/7-17F	DEMMY9PNM-A101
M24308/7-18Z	DAMMY15PNM
M24308/7-18F	DAMMY15PNM-A101
M24308/7-19Z	DBMMY25PNM
M24308/7-19F	DBMMY25PNM-A101
M24308/7-20Z	DCMMY37PNM
M24308/7-20F	DCMMY37PNM-A101
M24308/7-21Z	DDMMY50PNM
M24308/7-21F	DDMMY50PNM-A101
M24308/7-23	DEMM9PNMBK52
M24308/7-24	DAMM15PNMBK52
M24308/7-25	DBMM25PNMBK52
M24308/7-26	DCMM37PNMBK52
M24308/7-27	DDMM50PNMBK52
M24308/7-34	DEMMY9PNMBK52
M24308/7-35	DAMMY15PNMBK52
M24308/7-36	DBMMY25PNMBK52
M24308/7-37	DCMMY37PNMBK52
M24308/7-38	DDMMY50PNMBK52
M24308/7-39	DEMMY9PNMBK52
M24308/7-40	DAMMY15PNMBK52
M24308/7-41	DBMMY25PNMBK52
M24308/7-42	DCMMY37PNMBK52
M24308/7-43	DDMMY50PNMBK52

Gov't Designation	ITT Part Number
M24308/8-1Z	DEMAM9PNM
M24308/8-1F	DEMAM9PNM-A101
M24308/8-1P	DEMAM9PNM-F225
M24308/8-2Z	DAMAM15PNM
M24308/8-2F	DAMAM15PNM-A101
M24308/8-2P	DAMAM15PNM-F225
M24308/8-3Z	DBMAM25PNM
M24308/8-3F	DBMAM25PNM-A101
M24308/8-3P	DBMAM25PNM-F225
M24308/8-4Z	DCMAM37PNM
M24308/8-4F	DCMAM37PNM-A101
M24308/8-4P	DCMAM37PNM-F225
M24308/8-5Z	DDMAM50PNM
M24308/8-5F	DDMAM50PNM-A101
M24308/8-5P	DDMAM50PNM-F225
M24308/8-6Z	DEMAMT9PNM
M24308/8-6F	DEMAMT9PNM-A101
M24308/8-6P	DEMAMT9PNM-F225
M24308/8-7Z	DEMAMT15PNM
M24308/8-7F	DEMAMT15PNM-A101
M24308/8-7P	DEMAMT15PNM-F225
M24308/8-8Z	DBMAMT25PNM
M24308/8-8F	DBMAMT25PNM-A101
M24308/8-8P	DBMAMT25PNM-F225
M24308/8-9Z	DCMAMT37PNM
M24308/8-9F	DCMAMT37PNM-A101
M24308/8-9P	DCMAMT37PNM-F225
M24308/8-10Z	DDMAMT50PNM
M24308/8-10F	DDMAMT50PNM-A101
M24308/8-10P	DDMAMT50PNM-F225
M24308/8-11Z	DEMAM15PNM
M24308/8-11F	DEMAM15PNM-A101
M24308/8-11P	DEMAM15PNM-F225
M24308/8-12Z	DAMAM26PNM
M24308/8-12F	DAMAM26PNM-A101
M24308/8-12P	DAMAM26PNM-F225
M24308/8-13Z	DBMAM44PNM
M24308/8-13F	DBMAM44PNM-A101
M24308/8-13P	DBMAM44PNM-F225
M24308/8-14Z	DCMAM62PNM
M24308/8-14F	DCMAM62PNM-A101
M24308/8-14P	DCMAM62PNM-F225
M24308/8-15Z	DDMAM78PNM
M24308/8-15F	DDMAM78PNM-A101
M24308/8-15P	DDMAM78PNM-F225
M24308/8-17Z	DEMAMT15PNM
M24308/8-17F	DEMAMT15PNM-A101
M24308/8-17P	DEMAMT15PNM-F225
M24308/8-18Z	DAMAMT26PNM
M24308/8-18F	DAMAMT26PNM-A101
M24308/8-18P	DAMAMT26PNM-F225
M24308/8-19Z	DBMAMT44PNM
M24308/8-19F	DBMAMT44PNM-A101
M24308/8-19P	DBMAMT44PNM-F225
M24308/8-20Z	DCMAMT62PNM
M24308/8-20F	DCMAMT62PNM-A101
M24308/8-20P	DCMAMT62PNM-F225
M24308/8-21Z	DDMAMT78PNM

D Sub



Dimensions shown in inches (mm)  
Specifications and dimensions subject to change

www.ittcannon.com

Gov't Designation	ITT Part Number
M24308/8-21F	DDMAMT78PNM-A101
M24308/8-21P	DDMAMT78PNM-F225
M24308/8-259Z	DEMAM9PNM-FO
M24308/8-259F	DEMAM9PNM-A101-FO
M24308/8-259P	DEMAM9PNM-F225-FO
M24308/8-260Z	DAMAM15PNM-FO
M24308/8-260F	DAMAM15PNM-A101-FO
M24308/8-260P	DAMAM15PNM-F225-FO
M24308/8-261Z	DBMAM25PNM-FO
M24308/8-261F	DBMAM25PNM-A101-FO
M24308/8-261P	DBMAM25PNM-F225-FO
M24308/8-262Z	DCMAM37PNM-FO
M24308/8-262F	DCMAM37PNM-A101-FO
M24308/8-262P	DCMAM37PNM-F225-FO
M24308/8-263Z	DDMAM50PNM-FO
M24308/8-263F	DDMAM50PNM-A101-FO
M24308/8-263P	DDMAM50PNM-F225-FO
M24308/8-264Z	DEMAM15PNM-FO
M24308/8-264F	DEMAM15PNM-A101-FO
M24308/8-264P	DEMAM15PNM-F225-FO
M24308/8-265Z	DAMAM26PNM-FO
M24308/8-265F	DAMAM26PNM-A101-FO
M24308/8-265P	DAMAM26PNM-F225-FO
M24308/8-266Z	DBMAM44PNM-FO
M24308/8-266F	DBMAM44PNM-A101-FO
M24308/8-266P	DBMAM44PNM-F225-FO
M24308/8-267Z	DCMAM62PNM-FO
M24308/8-267F	DCMAM62PNM-A101-FO
M24308/8-267P	DCMAM62PNM-F225-FO
M24308/8-268Z	DDMAM78PNM-FO
M24308/8-268F	DDMAM78PNM-A101-FO
M24308/8-268P	DDMAM78PNM-F225-FO
M24308/8-302Z	DEMAMY9PNM
M24308/8-302F	DEMAMY9PNM-A101
M24308/8-303Z	DAMAMY15PNM
M24308/8-303F	DAMAMY15PNM-A101
M24308/8-304Z	DBMAMY25PNM
M24308/8-304F	DBMAMY25PNM-A101
M24308/8-305Z	DCMAMY37PNM
M24308/8-305F	DCMAMY37PNM-A101
M24308/8-306Z	DDMAMY50PNM
M24308/8-306F	DDMAMY50PNM-A101
M24308/8-307Z	DEMAMY15PNM
M24308/8-307F	DEMAMY15PNM-A101
M24308/8-308Z	DAMAMY26PNM
M24308/8-308F	DAMAMY26PNM-A101
M24308/8-309Z	DBMAMY44PNM
M24308/8-309F	DBMAMY44PNM-A101
M24308/8-310Z	DCMAMY62PNM
M24308/8-310F	DCMAMY62PNM-A101
M24308/8-311Z	DDMAMY78PNM
M24308/8-311F	DDMAMY78PNM-A101
M24308/8-313Z	DEMAMY9PNM
M24308/8-313F	DEMAMY9PNM-A101
M24308/8-314Z	DAMAMY15PNM
M24308/8-314F	DAMAMY15PNM-A101
M24308/8-315Z	DBMAMY25PNM
M24308/8-315F	DBMAMY25PNM-A101
M24308/8-316Z	DCMAMY37PNM

Gov't Designation	ITT Part Number
M24308/8-316F	DCMAMY37PNM-A101
M24308/8-317Z	DDMAMY50PNM
M24308/8-317F	DDMAMY50PNM-A101
M24308/8-318Z	DEMAMY15PNM
M24308/8-318F	DEMAMY15PNM-A101
M24308/8-319Z	DAMAMY26PNM
M24308/8-319F	DAMAMY26PNM-A101
M24308/8-320Z	DBMAMY44PNM
M24308/8-320F	DBMAMY44PNM-A101
M24308/8-321Z	DCMAMY62PNM
M24308/8-321F	DCMAMY62PNM-A101
M24308/8-322Z	DDMAMY78PNM
M24308/8-322F	DDMAMY78PNM-A101
M24308/8-324Z	DEMAMY9PNM-FO
M24308/8-324F	DEMAMY9PNM-FO-A101
M24308/8-325Z	DAMAMY15PNM-FO
M24308/8-325F	DAMAMY15PNM-FO-A101
M24308/8-326Z	DBMAMY25PNM-FO
M24308/8-326F	DBMAMY25PNM-FO-A101
M24308/8-327Z	DCMAMY37PNM-FO
M24308/8-327F	DCMAMY37PNM-FO-A101
M24308/8-328Z	DDMAMY50PNM-FO
M24308/8-328F	DDMAMY50PNM-A101-FO
M24308/8-329Z	DEMAMY15PNM-FO
M24308/8-329F	DEMAMY15PNM-A101-FO
M24308/8-330Z	DAMAMY26PNM-FO
M24308/8-331F	DAMAMY26PNM-A101-FO
M24308/8-331Z	DBMAMY44PNM-FO
M24308/8-332F	DBMAMY44PNM-A101-FO
M24308/8-332Z	DCMAMY62PNM-FO
M24308/8-333F	DCMAMY62PNM-A101-FO
M24308/8-333Z	DDMAMY78PNM-FO
M24308/8-333F	DDMAMY78PNM-A101-FO
M24308/8-335	DEMAM9PNMNBK52
M24308/8-336	DAMAM15PNMNBK52
M24308/8-337	DBMAM25PNMNBK52
M24308/8-338	DCMAM37PNMNBK52
M24308/8-339	DDMAM50PNMNBK52
M24308/8-340	DEMAMT9PNMNBK52
M24308/8-341	DEMAMT15PNMNBK52
M24308/8-342	DBMAMT25PNMNBK52
M24308/8-343	DCMAMT37PNMNBK52
M24308/8-344	DDMAMT50PNMNBK52
M24308/8-345	DEMAM15PNMNBK52
M24308/8-346	DAMAM26PNMNBK52
M24308/8-347	DBMAM44PNMNBK52
M24308/8-348	DCMAM62PNMNBK52
M24308/8-349	DDMAM78PNMNBK52
M24308/8-351	DEMAMT15PNMNBK52
M24308/8-352	DAMAMT26PNMNBK52
M24308/8-353	DBMAMT44PNMNBK52
M24308/8-354	DCMAMT62PNMNBK52
M24308/8-355	DDMAMT78PNMNBK52
M24308/8-357	DEMAM9PNMNBK52-FO
M24308/8-358	DAMAM15PNMNBK52-FO
M24308/8-359	DBMAM25PNMNBK52-FO
M24308/8-360	DCMAM37PNMNBK52-FO
M24308/8-361	DDMAM50PNMNBK52-FO

Gov't Designation	ITT Part Number
M24308/8-362	DEMAM15PNMNBK52-FO
M24308/8-363	DAMAM26PNMNBK52-FO
M24308/8-364	DBMAM44PNMNBK52-FO
M24308/8-365	DCMAM62PNMNBK52-FO
M24308/8-366	DDMAM78PNMNBK52-FO
M24308/8-368	DEMAMY9PNMNBK52
M24308/8-369	DAMAMY15PNMNBK52
M24308/8-370	DBMAMY25PNMNBK52
M24308/8-371	DCMAMY37PNMNBK52
M24308/8-372	DDMAMY50PNMNBK52
M24308/8-373	DEMAMY15PNMNBK52
M24308/8-374	DAMAMY26PNMNBK52
M24308/8-375	DBMAMY44PNMNBK52
M24308/8-376	DCMAMY62PNMNBK52
M24308/8-377	DDMAMY78PNMNBK52
M24308/8-379	DEMAMY9PNMNBK52
M24308/8-380	DAMAMY15PNMNBK52
M24308/8-381	DBMAMY25PNMNBK52
M24308/8-382	DCMAMY37PNMNBK52
M24308/8-383	DDMAMY50PNMNBK52
M24308/8-384	DEMAMY15PNMNBK52
M24308/8-385	DAMAMY26PNMNBK52
M24308/8-386	DBMAMY44PNMNBK52
M24308/8-387	DCMAMY62PNMNBK52
M24308/8-388	DDMAMY78PNMNBK52
M24308/8-390	DEMAMY9PNMNBK52-FO
M24308/8-391	DAMAMY15PNMNBK52-FO
M24308/8-392	DBMAMY25PNMNBK52-FO
M24308/8-393	DCMAMY37PNMNBK52-FO
M24308/8-394	DDMAMY50PNMNBK52-FO
M24308/8-395	DEMAMY15PNMNBK52-FO
M24308/8-396	DAMAMY26PNMNBK52-FO
M24308/8-397	DBMAMY44PNMNBK52-FO
M24308/8-398	DCMAMY62PNMNBK52-FO
M24308/8-399	DDMAMY78PNMNBK52-FO
M24308/8-401	DEMAMY9PNMNBK52
M24308/8-402	DAMAMY15PNMNBK52
M24308/8-403	DBMAMY25PNMNBK52
M24308/8-404	DCMAMY37PNMNBK52
M24308/8-405	DDMAMY50PNMNBK52
M24308/8-406	DEMAMY15PNMNBK52
M24308/8-407	DAMAMY26PNMNBK52
M24308/8-408	DBMAMY44PNMNBK52
M24308/8-409	DCMAMY62PNMNBK52
M24308/8-410	DDMAMY78PNMNBK52
M24308/8-412	DEMAMY9PNMNBK52
M24308/8-413	DAMAMY15PNMNBK52
M24308/8-414	DBMAMY25PNMNBK52
M24308/8-415	DCMAMY37PNMNBK52
M24308/8-416	DDMAMY50PNMNBK52
M24308/8-417	DEMAMY15PNMNBK52
M24308/8-418	DAMAMY26PNMNBK52
M24308/8-419	DBMAMY44PNMNBK52
M24308/8-420	DCMAMY62PNMNBK52
M24308/8-421	DDMAMY78PNMNBK52
M24308/8-423	DEMAMY9PNMNBK52-FO
M24308/8-424	DAMAMY15PNMNBK52-FO
M24308/8-425	DBMAMY25PNMNBK52-FO

Dimensions shown in inches (mm)  
 Specifications and dimensions subject to change

www.ittcannon.com





# M24308 Cross Reference

Gov't Designation	ITT Part Number
M24308/8-427	DDMAMY50PNMBK52-FO
M24308/8-428	DEMAMY15PNMBK52-FO
M24308/8-429	DAMAMY26PNMBK52-FO
M24308/8-430	DBMAMY44PNMBK52-FO
M24308/8-431	DCMAMY62PNMBK52-FO
M24308/8-432	DDMAMY78PNMBK52-FO
M24308/8-435Z	DEMAMY9PNM
M24308/8-435F	DEMAMY9PNM-A101
M24308/8-436Z	DAMAMY15PNM
M24308/8-436F	DAMAMY15PNM-A101
M24308/8-437Z	DBMAMY25PNM
M24308/8-437F	DBMAMY25PNM-A101
M24308/8-438Z	DCMAMY37PNM
M24308/8-438F	DCMAMY37PNM-A101
M24308/8-439Z	DDMAMY50PNM
M24308/8-439F	DDMAMY50PNM-A101
M24308/8-440Z	DEMAMY15PNM
M24308/8-440F	DEMAMY15PNM-A101
M24308/8-441Z	DAMAMY26PNM
M24308/8-441F	DAMAMY26PNM-A101
M24308/8-442Z	DBMAMY44PNM
M24308/8-442F	DBMAMY44PNM-A101
M24308/8-443Z	DCMAMY62PNM
M24308/8-443F	DCMAMY62PNM-A101
M24308/8-444Z	DDMAMY78PNM
M24308/8-444F	DDMAMY78PNM-A101
M24308/8-446Z	DEMAMYT9PNM
M24308/8-446F	DEMAMYT9PNM-A101
M24308/8-447Z	DAMAMYT15PNM
M24308/8-447F	DAMAMYT15PNM-A101
M24308/8-448Z	DBMAMYT25PNM
M24308/8-448F	DBMAMYT25PNM-A101
M24308/8-449Z	DCMAMYT37PNM
M24308/8-449F	DCMAMYT37PNM-A101
M24308/8-450Z	DDMAMY50PNM
M24308/8-450F	DDMAMY50PNM-A101
M24308/8-451Z	DEMAMYT15PNM
M24308/8-451F	DEMAMYT15PNM-A101
M24308/8-452Z	DAMAMYT26PNM
M24308/8-452F	DAMAMYT26PNM-A101
M24308/8-453Z	DBMAMYT44PNM
M24308/8-453F	DBMAMYT44PNM-A101
M24308/8-454Z	DCMAMYT62PNM
M24308/8-454F	DCMAMYT62PNM-A101
M24308/8-455Z	DDMAMY78PNM
M24308/8-455F	DDMAMY78PNM-A101
M24308/8-457Z	DEMAMY9PNM-FO
M24308/8-457F	DEMAMY9PNM-A101-FO
M24308/8-458Z	DAMAMY15PNM-FO
M24308/8-458F	DAMAMY15PNM-A101-FO
M24308/8-459Z	DBMAMY25PNM-FO
M24308/8-459F	DBMAMY25PNM-A101-FO
M24308/8-460Z	DCMAMY37PNM-FO
M24308/8-460F	DCMAMY37PNM-A101-FO
M24308/8-461Z	DDMAMY50PNM-FO
M24308/8-461F	DDMAMY50PNM-A101-FO
M24308/8-462Z	DEMAMY15PNM-FO
M24308/8-462F	DEMAMY15PNM-A101-FO
M24308/8-463Z	DAMAMY26PNM-FO

Gov't Designation	ITT Part Number
M24308/8-463F	DAMAMY26PNM-A101-FO
M24308/8-464Z	DBMAMY44PNM-FO
M24308/8-464F	DBMAMY44PNM-A101-FO
M24308/8-465Z	DCMAMY62PNM-FO
M24308/8-465F	DCMAMY62PNM-A101-FO
M24308/8-466Z	DDMAMY78PNM-FO
M24308/8-466F	DDMAMY78PNM-A101-FO
M24308/9-1	DEH9P002
M24308/9-2	DAH15P002
M24308/9-3	DBH25P002
M24308/9-4	DCH37P002
M24308/9-5	DDH50P002
M24308/9-6	DEH9P001
M24308/9-7	DAH15P001
M24308/9-8	DBH25P001
M24308/9-9	DCH37P001
M24308/9-10	DDH50P001
M24308/9-11	DEH9P202
M24308/9-12	DAH15P202
M24308/9-13	DBH25P202
M24308/9-14	DCH37P202
M24308/9-15	DDH50P202
M24308/9-16	DEH9P201
M24308/9-17	DAH15P201
M24308/9-18	DBH25P201
M24308/9-19	DCH37P201
M24308/9-20	DDH50P201
M24308/23-1Z	DEM9SM
M24308/23-1F	DEM9SM-A101
M24308/23-1P	DEM9SM-F225
M24308/23-2Z	DAMM15SM
M24308/23-2F	DAMM15SM-A101
M24308/23-2P	DAMM15SM-F225
M24308/23-3Z	DBMM25SM
M24308/23-3F	DBMM25SM-A101
M24308/23-3P	DBMM25SM-F225
M24308/23-4Z	DCMM37SM
M24308/23-4F	DCMM37SM-A101
M24308/23-4P	DCMM37SM-F225
M24308/23-5Z	DDMM50SM
M24308/23-5F	DDMM50SM-A101
M24308/23-5P	DDMM50SM-F225
M24308/23-7Z	DEM9SZ
M24308/23-7F	DEM9SZ-A101
M24308/23-7P	DEM9SZ-F225
M24308/23-8Z	DAMM15SZ
M24308/23-8F	DAMM15SZ-A101
M24308/23-8P	DAMM15SZ-F225
M24308/23-9Z	DBMM25SZ
M24308/23-9F	DBMM25SZ-A101
M24308/23-9P	DBMM25SZ-F225
M24308/23-10Z	DCMM37SZ
M24308/23-10F	DCMM37SZ-A101
M24308/23-10P	DCMM37SZ-F225
M24308/23-11Z	DDMM50SZ
M24308/23-11F	DDMM50SZ-A101
M24308/23-11P	DDMM50SZ-F225
M24308/23-13Z	DEM9SH
M24308/23-13F	DEM9SH-A101

Gov't Designation	ITT Part Number
M24308/23-13P	DEM9SH-F225
M24308/23-14Z	DAMM15SH
M24308/23-14F	DAMM15SH-A101
M24308/23-14P	DAMM15SH-F225
M24308/23-15Z	DBMM25SH
M24308/23-15F	DBMM25SH-A101
M24308/23-15P	DBMM25SH-F225
M24308/23-16Z	DCMM37SH
M24308/23-16F	DCMM37SH-A101
M24308/23-16P	DCMM37SH-F225
M24308/23-17Z	DDMM50SH
M24308/23-17F	DDMM50SH-A101
M24308/23-17P	DDMM50SH-F225
M24308/23-19Z	DEM9SX
M24308/23-19F	DEM9SX-A101
M24308/23-19P	DEM9SX-F225
M24308/23-20Z	DAMM15SX
M24308/23-20F	DAMM15SX-A101
M24308/23-20P	DAMM15SX-F225
M24308/23-21Z	DBMM25SX
M24308/23-21F	DBMM25SX-A101
M24308/23-21P	DBMM25SX-F225
M24308/23-22Z	DCMM37SX
M24308/23-22F	DCMM37SX-A101
M24308/23-22P	DCMM37SX-F225
M24308/23-23Z	DDMM50SX
M24308/23-23F	DDMM50SX-A101
M24308/23-23P	DDMM50SX-F225
M24308/23-25Z	DEM9SD
M24308/23-25F	DEM9SD-A101
M24308/23-26Z	DAMM15SD
M24308/23-26F	DAMM15SD-A101
M24308/23-27Z	DBMM25SD
M24308/23-27F	DBMM25SD-A101
M24308/23-28Z	DCMM37SD
M24308/23-28F	DCMM37SD-A101
M24308/23-29Z	DDMM50SD
M24308/23-29F	DDMM50SD-A101
M24308/23-31Z	DEM9SL
M24308/23-31F	DEM9SL-A101
M24308/23-32Z	DAMM15SL
M24308/23-32F	DAMM15SL-A101
M24308/23-33Z	DBMM25SL
M24308/23-33F	DBMM25SL-A101
M24308/23-34Z	DCMM37SL
M24308/23-34F	DCMM37SL-A101
M24308/23-35Z	DDMM50SL
M24308/23-35F	DDMM50SL-A101
M24308/23-37Z	DEM9SA
M24308/23-37F	DEM9SA-A101
M24308/23-38Z	DAMM15SA
M24308/23-38F	DAMM15SA-A101
M24308/23-39Z	DBMM25SA
M24308/23-39F	DBMM25SA-A101
M24308/23-40Z	DCMM37SA
M24308/23-40F	DCMM37SA-A101
M24308/23-41Z	DDMM50SA
M24308/23-41F	DDMM50SA-A101
M24308/23-43Z	DEM9SG

D Sub



Dimensions shown in inches (mm)  
Specifications and dimensions subject to change

www.ittcannon.com

Gov't Designation	ITT Part Number
M24308/23-43F	DEM9SG-A101
M24308/23-44Z	DAMM15SG
M24308/23-44F	DAMM15SG-A101
M24308/23-45Z	DBMM25SG
M24308/23-45F	DBMM25SG-A101
M24308/23-46Z	DCMM37SG
M24308/23-46F	DCMM37SG-A101
M24308/23-47Z	DDMM50SG
M24308/23-47F	DDMM50SG-A101
M24308/23-49Z	DEM9SS
M24308/23-49F	DEM9SS-A101
M24308/23-50Z	DAMM15SS
M24308/23-50F	DAMM15SS-A101
M24308/23-51Z	DBMM25SS
M24308/23-51F	DBMM25SS-A101
M24308/23-52Z	DCMM37SS
M24308/23-52F	DCMM37SS-A101
M24308/23-53Z	DDMM50SS
M24308/23-53F	DDMM50SS-A101
M24308/23-55Z	DEM9SW
M24308/23-55F	DEM9SW-A101
M24308/23-56Z	DAMM15SW
M24308/23-56F	DAMM15SW-A101
M24308/23-57Z	DBMM25SW
M24308/23-57F	DBMM25SW-A101
M24308/23-58Z	DCMM37SW
M24308/23-58F	DCMM37SW-A101
M24308/23-59Z	DDMM50SW
M24308/23-59F	DDMM50SW-A101
M24308/23-61Z	DEMAM15SM
M24308/23-61F	DEMAM15SM-A101
M24308/23-61P	DEMAM15SM-F225
M24308/23-62Z	DAMAM25SM
M24308/23-62F	DAMAM25SM-A101
M24308/23-62P	DAMAM25SM-F225
M24308/23-63Z	DBMAM44SM
M24308/23-63F	DBMAM44SM-A101
M24308/23-63P	DBMAM44SM-F225
M24308/23-64Z	DCMAM62SM
M24308/23-64F	DCMAM62SM-A101
M24308/23-64P	DCMAM62SM-F225
M24308/23-65Z	DDMAM78SM
M24308/23-65F	DDMAM78SM-A101
M24308/23-65P	DDMAM78SM-F225
M24308/23-67Z	DEMAM15SQ
M24308/23-67F	DEMAM15SQ-A101
M24308/23-67P	DEMAM15SQ-F225
M24308/23-68Z	DAMAM25SQ
M24308/23-68F	DAMAM25SQ-A101
M24308/23-68P	DAMAM25SQ-F225
M24308/23-69Z	DBMAM44SQ
M24308/23-69F	DBMAM44SQ-A101
M24308/23-69P	DBMAM44SQ-F225
M24308/23-70Z	DCMAM62SQ
M24308/23-70F	DCMAM62SQ-A101
M24308/23-70P	DCMAM62SQ-F225
M24308/23-71Z	DDMAM78SQ
M24308/23-71F	DDMAM78SQ-A101
M24308/23-71P	DDMAM78SQ-F225

Gov't Designation	ITT Part Number
M24308/23-73Z	DEMAM15SA
M24308/23-73F	DEMAM15SA-A101
M24308/23-74Z	DAMAM25SA
M24308/23-74F	DAMAM25SA-A101
M24308/23-75Z	DBMAM44SA
M24308/23-75F	DBMAM44SA-A101
M24308/23-76Z	DCMAM62SA
M24308/23-76F	DCMAM62SA-A101
M24308/23-77Z	DDMAM78SA
M24308/23-77F	DDMAM78SA-A101
M24308/23-101	DEM9SMNMBK52
M24308/23-102	DAMM15SMNMBK52
M24308/23-103	DBMM25SMNMBK52
M24308/23-104	DCMM37SMNMBK52
M24308/23-105	DDMM50SMNMBK52
M24308/23-107	DEM9SZNMBK52
M24308/23-108	DAMM15SZNMBK52
M24308/23-109	DBMM25SZNMBK52
M24308/23-110	DCMM37SZNMBK52
M24308/23-111	DDMM50SZNMBK52
M24308/23-113	DEM9SHNMBK52
M24308/23-114	DAMM15SHNMBK52
M24308/23-115	DBMM25SHNMBK52
M24308/23-116	DCMM37SHNMBK52
M24308/23-117	DDMM50SHNMBK52
M24308/23-119	DEM9SXNMBK52
M24308/23-120	DAMM15SXNMBK52
M24308/23-121	DBMM25SXNMBK52
M24308/23-122	DCMM37SXNMBK52
M24308/23-123	DDMM50SXNMBK52
M24308/23-125	DEM9SDNMBK52
M24308/23-126	DAMM15SDNMBK52
M24308/23-127	DBMM25SDNMBK52
M24308/23-128	DCMM37SDNMBK52
M24308/23-129	DDMM50SDNMBK52
M24308/23-131	DEM9SLNMBK52
M24308/23-132	DAMM15SLNMBK52
M24308/23-133	DBMM25SLNMBK52
M24308/23-134	DCMM37SLNMBK52
M24308/23-135	DDMM50SLNMBK52
M24308/23-137	DEM9SANMBK52
M24308/23-138	DAMM15SANMBK52
M24308/23-139	DBMM25SANMBK52
M24308/23-140	DCMM37SANMBK52
M24308/23-141	DDMM50SANMBK52
M24308/23-143	DEM9SGNMBK52
M24308/23-144	DAMM15SGNMBK52
M24308/23-145	DBMM25SGNMBK52
M24308/23-146	DCMM37SGNMBK52
M24308/23-147	DDMM50SGNMBK52
M24308/23-149	DEM9SSNMBK52
M24308/23-150	DAMM15SSNMBK52
M24308/23-151	DBMM25SSNMBK52
M24308/23-152	DCMM37SSNMBK52
M24308/23-153	DDMM50SSNMBK52
M24308/23-155	DEM9SWNMBK52
M24308/23-156	DAMM15SWNMBK52
M24308/23-157	DBMM25SWNMBK52
M24308/23-158	DCMM37SWNMBK52

Gov't Designation	ITT Part Number
M24308/23-159	DDMM50SWNMBK52
M24308/23-161Z	DEMAM15SMNMBK52
M24308/23-162Z	DAMAM25SMNMBK52
M24308/23-163Z	DBMAM44SMNMBK52
M24308/23-164Z	DCMAM62SMNMBK52
M24308/23-165Z	DDMAM78SMNMBK52
M24308/23-167Z	DEMAM15SQNMBK52
M24308/23-168Z	DAMAM25SQNMBK52
M24308/23-169Z	DBMAM44SQNMBK52
M24308/23-170Z	DCMAM62SQNMBK52
M24308/23-171Z	DDMAM78SQNMBK52
M24308/23-173Z	DEMAM15SANMBK52
M24308/23-174Z	DAMAM25SANMBK52
M24308/23-175Z	DBMAM44SANMBK52
M24308/23-176Z	DCMAM62SANMBK52
M24308/23-177Z	DDMAM78SANMBK52
M24308/23-201Z	DEM9SMNM
M24308/23-201F	DEM9SMNM-A101
M24308/23-201P	DEM9SMNM-F225
M24308/23-202Z	DAMM15SMNM
M24308/23-202F	DAMM15SMNM-A101
M24308/23-202P	DAMM15SMNM-F225
M24308/23-203Z	DBMM25SMNM
M24308/23-203F	DBMM25SMNM-A101
M24308/23-203P	DBMM25SMNM-F225
M24308/23-204Z	DCMM37SMNM
M24308/23-204F	DCMM37SMNM-A101
M24308/23-204P	DCMM37SMNM-F225
M24308/23-205Z	DDMM50SMNM
M24308/23-205F	DDMM50SMNM-A101
M24308/23-205P	DDMM50SMNM-F225
M24308/23-207Z	DEM9SZNM
M24308/23-207F	DEM9SZNM-A101
M24308/23-207P	DEM9SZNM-F225
M24308/23-208Z	DAMM15SZNM
M24308/23-208F	DAMM15SZNM-A101
M24308/23-208P	DAMM15SZNM-F225
M24308/23-209Z	DBMM25SZNM
M24308/23-209F	DBMM25SZNM-A101
M24308/23-209P	DBMM25SZNM-F225
M24308/23-210Z	DCMM37SZNM
M24308/23-210F	DCMM37SZNM-A101
M24308/23-210P	DCMM37SZNM-F225
M24308/23-211Z	DDMM50SZNM
M24308/23-211F	DDMM50SZNM-A101
M24308/23-211P	DDMM50SZNM-F225
M24308/23-213Z	DEM9SHNM
M24308/23-213F	DEM9SHNM-A101
M24308/23-213P	DEM9SHNM-F225
M24308/23-214Z	DAMM15SHNM
M24308/23-214F	DAMM15SHNM-A101
M24308/23-214P	DAMM15SHNM-F225
M24308/23-215Z	DBMM25SHNM
M24308/23-215F	DBMM25SHNM-A101
M24308/23-215P	DBMM25SHNM-F225
M24308/23-216Z	DCMM37SHNM
M24308/23-216F	DCMM37SHNM-A101
M24308/23-216P	DCMM37SHNM-F225
M24308/23-217Z	DDMM50SHNM

Dimensions shown in inches (mm)  
 Specifications and dimensions subject to change

# M24308 Cross Reference

Gov't Designation	ITT Part Number
M24308/23-217F	DDMM50SHNM-A101
M24308/23-217P	DDMM50SHNM-F225
M24308/23-219Z	DEM9SXNM
M24308/23-219F	DEM9SXNM-A101
M24308/23-219P	DEM9SXNM-F225
M24308/23-220Z	DAMM15SXNM
M24308/23-220F	DAMM15SXNM-A101
M24308/23-220P	DAMM15SXNM-F225
M24308/23-221Z	DBMM25SXNM
M24308/23-221F	DBMM25SXNM-A101
M24308/23-221P	DBMM25SXNM-F225
M24308/23-222Z	DCMM37SXNM
M24308/23-222F	DCMM37SXNM-A101
M24308/23-222P	DCMM37SXNM-F225
M24308/23-223Z	DDMM50SXNM
M24308/23-223F	DDMM50SXNM-A101
M24308/23-223P	DDMM50SXNM-F225
M24308/23-225Z	DEM9SDNM
M24308/23-225F	DEM9SDNM-A101
M24308/23-226Z	DAMM15SDNM
M24308/23-226F	DAMM15SDNM-A101
M24308/23-227Z	DBMM25SDNM
M24308/23-227F	DBMM25SDNM-A101
M24308/23-228Z	DCMM37SDNM
M24308/23-228F	DCMM37SDNM-A101
M24308/23-229Z	DDMM50SDNM
M24308/23-229F	DDMM50SDNM-A101
M24308/23-231Z	DEM9SLNM
M24308/23-231F	DEM9SLNM-A101
M24308/23-232Z	DAMM15SLNM
M24308/23-232F	DAMM15SLNM-A101
M24308/23-233Z	DBMM25SLNM
M24308/23-233F	DBMM25SLNM-A101
M24308/23-234Z	DCMM37SLNM
M24308/23-234F	DCMM37SLNM-A101
M24308/23-235Z	DDMM50SLNM
M24308/23-235F	DDMM50SLNM-A101
M24308/23-237Z	DEM9SANM
M24308/23-237F	DEM9SANM-A101
M24308/23-238Z	DAMM15SANM
M24308/23-238F	DAMM15SANM-A101
M24308/23-239Z	DBMM25SANM
M24308/23-239F	DBMM25SANM-A101
M24308/23-240Z	DCMM37SANM
M24308/23-240F	DCMM37SANM-A101
M24308/23-241Z	DDMM50SANM
M24308/23-241F	DDMM50SANM-A101
M24308/23-243Z	DEM9SGNM
M24308/23-243F	DEM9SGNM-A101
M24308/23-244Z	DAMM15SGNM
M24308/23-244F	DAMM15SGNM-A101
M24308/23-245Z	DBMM25SGNM
M24308/23-245F	DBMM25SGNM-A101
M24308/23-246Z	DCMM37SGNM
M24308/23-246F	DCMM37SGNM-A101
M24308/23-247Z	DDMM50SGNM
M24308/23-247F	DDMM50SGNM-A101
M24308/23-249Z	DEM9SSNM
M24308/23-249F	DEM9SSNM-A101

Gov't Designation	ITT Part Number
M24308/23-250Z	DAMM15SSNM
M24308/23-250F	DAMM15SSNM-A101
M24308/23-251Z	DBMM25SSNM
M24308/23-251F	DBMM25SSNM-A101
M24308/23-252Z	DCMM37SSNM
M24308/23-252F	DCMM37SSNM-A101
M24308/23-253Z	DDMM50SSNM
M24308/23-253F	DDMM50SSNM-A101
M24308/23-255Z	DEM9SWNM
M24308/23-255F	DEM9SWNM-A101
M24308/23-256Z	DAMM15SWNM
M24308/23-256F	DAMM15SWNM-A101
M24308/23-257Z	DBMM25SWNM
M24308/23-257F	DBMM25SWNM-A101
M24308/23-258Z	DCMM37SWNM
M24308/23-258F	DCMM37SWNM-A101
M24308/23-259Z	DDMM50SWNM
M24308/23-259F	DDMM50SWNM-A101
M24308/23-261Z	DEMAM15SMNM
M24308/23-261F	DEMAM15SMNM-A101
M24308/23-261P	DEMAM15SMNM-F225
M24308/23-262Z	DAMAM25SMNM
M24308/23-262F	DAMAM25SMNM-A101
M24308/23-262P	DAMAM25SMNM-F225
M24308/23-263Z	DBMAM44SMNM
M24308/23-263F	DBMAM44SMNM-A101
M24308/23-263P	DBMAM44SMNM-F225
M24308/23-264Z	DCMAM62SMNM
M24308/23-264F	DCMAM62SMNM-A101
M24308/23-264P	DCMAM62SMNM-F225
M24308/23-265Z	DDMAM78SMNM
M24308/23-265F	DDMAM78SMNM-A101
M24308/23-265P	DDMAM78SMNM-F225
M24308/23-267Z	DEMAM15SQNM
M24308/23-267F	DEMAM15SQNM-A101
M24308/23-267P	DEMAM15SQNM-F225
M24308/23-268Z	DAMAM25SQNM
M24308/23-268F	DAMAM25SQNM-A101
M24308/23-268P	DAMAM25SQNM-F225
M24308/23-269Z	DBMAM44SQNM
M24308/23-269F	DBMAM44SQNM-A101
M24308/23-269P	DBMAM44SQNM-F225
M24308/23-270Z	DCMAM62SQNM
M24308/23-270F	DCMAM62SQNM-A101
M24308/23-270P	DCMAM62SQNM-F225
M24308/23-271Z	DDMAM78SQNM
M24308/23-271F	DDMAM78SQNM-A101
M24308/23-271P	DDMAM78SQNM-F225
M24308/23-273Z	DEMAM15SANM
M24308/23-273F	DEMAM15SANM-A101
M24308/23-274Z	DAMAM25SANM
M24308/23-274F	DAMAM25SANM-A101
M24308/23-275Z	DBMAM44SANM
M24308/23-275F	DBMAM44SANM-A101
M24308/23-276Z	DCMAM62SANM
M24308/23-276F	DCMAM62SANM-A101
M24308/23-277Z	DDMAM78SANM
M24308/23-277F	DDMAM78SANM-A101
M24308/24-1Z	DEM9PM

Gov't Designation	ITT Part Number
M24308/24-1F	DEM9PM-A101
M24308/24-1P	DEM9PM-F225
M24308/24-2Z	DAMM15PM
M24308/24-2F	DAMM15PM-A101
M24308/24-2P	DAMM15PM-F225
M24308/24-3Z	DBMM25PM
M24308/24-3F	DBMM25PM-A101
M24308/24-3P	DBMM25PM-F225
M24308/24-4Z	DCMM37PM
M24308/24-4F	DCMM37PM-A101
M24308/24-4P	DCMM37PM-F225
M24308/24-5Z	DDMM50PM
M24308/24-5F	DDMM50PM-A101
M24308/24-5P	DDMM50PM-F225
M24308/24-7Z	DEM9PZ
M24308/24-7F	DEM9PZ-A101
M24308/24-7P	DEM9PZ-F225
M24308/24-8Z	DAMM15PZ
M24308/24-8F	DAMM15PZ-A101
M24308/24-8P	DAMM15PZ-F225
M24308/24-9Z	DBMM25PZ
M24308/24-9F	DBMM25PZ-A101
M24308/24-9P	DBMM25PZ-F225
M24308/24-10Z	DCMM37PZ
M24308/24-10F	DCMM37PZ-A101
M24308/24-10P	DCMM37PZ-F225
M24308/24-11Z	DDMM50PZ
M24308/24-11F	DDMM50PZ-A101
M24308/24-11P	DDMM50PZ-F225
M24308/24-13Z	DEM9PH
M24308/24-13F	DEM9PH-A101
M24308/24-13P	DEM9PH-F225
M24308/24-14Z	DAMM15PH
M24308/24-14F	DAMM15PH-A101
M24308/24-14P	DAMM15PH-F225
M24308/24-15Z	DBMM25PH
M24308/24-15F	DBMM25PH-A101
M24308/24-15P	DBMM25PH-F225
M24308/24-16Z	DCMM37PH
M24308/24-16F	DCMM37PH-A101
M24308/24-16P	DCMM37PH-F225
M24308/24-17Z	DDMM50PH
M24308/24-17F	DDMM50PH-A101
M24308/24-17P	DDMM50PH-F225
M24308/24-19Z	DEM9PX
M24308/24-19F	DEM9PX-A101
M24308/24-19P	DEM9PX-F225
M24308/24-20Z	DAMM15PX
M24308/24-20F	DAMM15PX-A101
M24308/24-20P	DAMM15PX-F225
M24308/24-21Z	DBMM25PX
M24308/24-21F	DBMM25PX-A101
M24308/24-21P	DBMM25PX-F225
M24308/24-22Z	DCMM37PX
M24308/24-22F	DCMM37PX-A101
M24308/24-22P	DCMM37PX-F225
M24308/24-23Z	DDMM50PX
M24308/24-23F	DDMM50PX-A101
M24308/24-23P	DDMM50PX-F225

D Sub



Dimensions shown in inches (mm)  
Specifications and dimensions subject to change

www.ittcannon.com



Gov't Designation	ITT Part Number
M24308/24-25Z	DEMMP9PD
M24308/24-25F	DEMMP9PD-A101
M24308/24-26Z	DAMM15PD
M24308/24-26F	DAMM15PD-A101
M24308/24-27Z	DBMM25PD
M24308/24-27F	DBMM25PD-A101
M24308/24-28Z	DCMM37PD
M24308/24-28F	DCMM37PD-A101
M24308/24-29Z	DDMM50PD
M24308/24-29F	DDMM50PD-A101
M24308/24-31Z	DEMMP9PL
M24308/24-31F	DEMMP9PL-A101
M24308/24-32Z	DAMM15PL
M24308/24-32F	DAMM15PL-A101
M24308/24-33Z	DBMM25PL
M24308/24-33F	DBMM25PL-A101
M24308/24-34Z	DCMM37PL
M24308/24-34F	DCMM37PL-A101
M24308/24-35Z	DDMM50PL
M24308/24-35F	DDMM50PL-A101
M24308/24-37Z	DEMMP9PA
M24308/24-37F	DEMMP9PA-A101
M24308/24-38Z	DAMM15PA
M24308/24-38F	DAMM15PA-A101
M24308/24-39Z	DBMM25PA
M24308/24-39F	DBMM25PA-A101
M24308/24-40Z	DCMM37PA
M24308/24-40F	DCMM37PA-A101
M24308/24-41Z	DDMM50PA
M24308/24-41F	DDMM50PA-A101
M24308/24-43Z	DEMMP9PG
M24308/24-43F	DEMMP9PG-A101
M24308/24-44Z	DAMM15PG
M24308/24-44F	DAMM15PG-A101
M24308/24-45Z	DBMM25PG
M24308/24-45F	DBMM25PG-A101
M24308/24-46Z	DCMM37PG
M24308/24-46F	DCMM37PG-A101
M24308/24-47Z	DDMM50PG
M24308/24-47F	DDMM50PG-A101
M24308/24-49Z	DEMMP9PS
M24308/24-49F	DEMMP9PS-A101
M24308/24-50Z	DAMM15PS
M24308/24-50F	DAMM15PS-A101
M24308/24-51Z	DBMM25PS
M24308/24-51F	DBMM25PS-A101
M24308/24-52Z	DCMM37PS
M24308/24-52F	DCMM37PS-A101
M24308/24-53Z	DDMM50PS
M24308/24-53F	DDMM50PS-A101
M24308/24-55Z	DEMMP9PW
M24308/24-55F	DEMMP9PW-A101
M24308/24-56Z	DAMM15PW
M24308/24-56F	DAMM15PW-A101
M24308/24-57Z	DBMM25PW
M24308/24-57F	DBMM25PW-A101
M24308/24-58Z	DCMM37PW
M24308/24-58F	DCMM37PW-A101
M24308/24-59Z	DDMM50PW

Gov't Designation	ITT Part Number
M24308/24-59F	DDMM50PW-A101
M24308/24-61Z	DEMAM15PM
M24308/24-61F	DEMAM15PM-A101
M24308/24-61P	DEMAM15PM-F225
M24308/24-62Z	DAMAM25PM
M24308/24-62F	DAMAM25PM-A101
M24308/24-62P	DAMAM25PM-F225
M24308/24-63Z	DBMAM44PM
M24308/24-63F	DBMAM44PM-A101
M24308/24-63P	DBMAM44PM-F225
M24308/24-64Z	DCMAM62PM
M24308/24-64F	DCMAM62PM-A101
M24308/24-64P	DCMAM62PM-F225
M24308/24-65Z	DDMAM78PM
M24308/24-65F	DDMAM78PM-A101
M24308/24-65P	DDMAM78PM-F225
M24308/24-67Z	DEMAM15PQ
M24308/24-67F	DEMAM15PQ-A101
M24308/24-67P	DEMAM15PQ-F225
M24308/24-68Z	DAMAM25PQ
M24308/24-68F	DAMAM25PQ-A101
M24308/24-68P	DAMAM25PQ-F225
M24308/24-69Z	DBMAM44PQ
M24308/24-69F	DBMAM44PQ-A101
M24308/24-69P	DBMAM44PQ-F225
M24308/24-70Z	DCMAM62PQ
M24308/24-70F	DCMAM62PQ-A101
M24308/24-70P	DCMAM62PQ-F225
M24308/24-71Z	DDMAM78PQ
M24308/24-71F	DDMAM78PQ-A101
M24308/24-71P	DDMAM78PQ-F225
M24308/24-73Z	DEMAM15PA
M24308/24-73F	DEMAM15PA-A101
M24308/24-73P	DEMAM15PA-F225
M24308/24-74Z	DAMAM25PA
M24308/24-74F	DAMAM25PA-A101
M24308/24-74P	DAMAM25PA-F225
M24308/24-75Z	DBMAM44PA
M24308/24-75F	DBMAM44PA-A101
M24308/24-75P	DBMAM44PA-F225
M24308/24-76Z	DCMAM62PA
M24308/24-76F	DCMAM62PA-A101
M24308/24-76P	DCMAM62PA-F225
M24308/24-77Z	DDMAM78PA
M24308/24-77F	DDMAM78PA-A101
M24308/24-77P	DDMAM78PA-F225
M24308/24-101	DEMMP9PMNMBK52
M24308/24-102	DAMM15PMNMBK52
M24308/24-103	DBMM25PMNMBK52
M24308/24-104	DCMM37PMNMBK52
M24308/24-105	DDMM50PMNMBK52
M24308/24-107	DEMMP9PNMBK52
M24308/24-108	DAMM15PNMBK52
M24308/24-109	DBMM25PNMBK52
M24308/24-110	DCMM37PNMBK52
M24308/24-111	DDMM50PNMBK52
M24308/24-113	DEMMP9PHNMBK52
M24308/24-114	DAMM15PHNMBK52
M24308/24-115	DBMM25PHNMBK52

Gov't Designation	ITT Part Number
M24308/24-115	DBMM25PHNMBK52
M24308/24-116	DCMM37PHNMBK52
M24308/24-117	DDMM50PHNMBK52
M24308/24-119	DEMMP9PXNMBK52
M24308/24-120	DAMM15PXNMBK52
M24308/24-121	DBMM25PXNMBK52
M24308/24-122	DCMM37PXNMBK52
M24308/24-123	DDMM50PXNMBK52
M24308/24-125	DEMMP9PDNMBK52
M24308/24-126	DAMM15PDNMBK52
M24308/24-127	DBMM25PDNMBK52
M24308/24-128	DCMM37PDNMBK52
M24308/24-129	DDMM50PDNMBK52
M24308/24-131	DEMMP9PLNMBK52
M24308/24-132	DAMM15PLNMBK52
M24308/24-133	DBMM25PLNMBK52
M24308/24-134	DCMM37PLNMBK52
M24308/24-135	DDMM50PLNMBK52
M24308/24-137	DEMMP9PANMBK52
M24308/24-138	DAMM15PANMBK52
M24308/24-139	DBMM25PANMBK52
M24308/24-140	DCMM37PANMBK52
M24308/24-141	DDMM50PANMBK52
M24308/24-143	DEMMP9PGNMBK52
M24308/24-144	DAMM15PGNMBK52
M24308/24-145	DBMM25PGNMBK52
M24308/24-146	DCMM37PGNMBK52
M24308/24-147	DDMM50PGNMBK52
M24308/24-149	DEMMP9PSNMBK52
M24308/24-150	DAMM15PSNMBK52
M24308/24-151	DBMM25PSNMBK52
M24308/24-152	DCMM37PSNMBK52
M24308/24-153	DDMM50PSNMBK52
M24308/24-155	DEMMP9PWNMBK52
M24308/24-156	DAMM15PWNMBK52
M24308/24-157	DBMM25PWNMBK52
M24308/24-158	DCMM37PWNMBK52
M24308/24-159	DDMM50PWNMBK52
M24308/24-161Z	DEMAM15PMNMBK52
M24308/24-162Z	DAMAM25PMNMBK52
M24308/24-163Z	DBMAM44PMNMBK52
M24308/24-164Z	DCMAM62PMNMBK52
M24308/24-165Z	DDMAM78PMNMBK52
M24308/24-167Z	DEMAM15PQNMBK52
M24308/24-168Z	DAMAM25PQNMBK52
M24308/24-169Z	DBMAM44PQNMBK52
M24308/24-170Z	DCMAM62PQNMBK52
M24308/24-171Z	DDMAM78PQNMBK52
M24308/24-173Z	DEMAM15PANMBK52
M24308/24-174Z	DAMAM25PANMBK52
M24308/24-175Z	DBMAM44PANMBK52
M24308/24-176Z	DCMAM62PANMBK52
M24308/24-177Z	DDMAM78PANMBK52
M24308/24-201Z	DEMMP9PMNM
M24308/24-201F	DEMMP9PMNM-A101
M24308/24-201P	DEMMP9PMNM-F225
M24308/24-202Z	DAMM15PMNM
M24308/24-202F	DAMM15PMNM-A101
M24308/24-202P	DAMM15PMNM-F225
M24308/24-203Z	DBMM25PMNM

Dimensions shown in inches (mm)  
 Specifications and dimensions subject to change

# M24308 Cross Reference

Gov't Designation	ITT Part Number
M24308/24-203F	DBMM25PMNM-A101
M24308/24-203P	DBMM25PMNM-F225
M24308/24-204Z	DCMM37PMNM
M24308/24-204F	DCMM37PMNM-A101
M24308/24-204P	DCMM37PMNM-F225
M24308/24-205Z	DDMM50PMNM
M24308/24-205F	DDMM50PMNM-A101
M24308/24-205P	DDMM50PMNM-F225
M24308/24-207Z	DEMM9PZNM
M24308/24-207F	DEMM9PZNM-A101
M24308/24-207P	DEMM9PZNM-F225
M24308/24-208Z	DAMM15PZNM
M24308/24-208F	DAMM15PZNM-A101
M24308/24-208P	DAMM15PZNM-F225
M24308/24-209Z	DBMM25PZNM
M24308/24-209F	DBMM25PZNM-A101
M24308/24-209P	DBMM25PZNM-F225
M24308/24-210Z	DCMM37PZNM
M24308/24-210F	DCMM37PZNM-A101
M24308/24-210P	DCMM37PZNM-F225
M24308/24-211Z	DDMM50PZNM
M24308/24-211F	DDMM50PZNM-A101
M24308/24-211P	DDMM50PZNM-F225
M24308/24-213Z	DEMM9PHNM
M24308/24-213F	DEMM9PHNM-A101
M24308/24-213P	DEMM9PHNM-F225
M24308/24-214Z	DAMM15PHNM
M24308/24-214F	DAMM15PHNM-A101
M24308/24-214P	DAMM15PHNM-F225
M24308/24-215Z	DBMM25PHNM
M24308/24-215F	DBMM25PHNM-A101
M24308/24-215P	DBMM25PHNM-F225
M24308/24-216Z	DCMM37PHNM
M24308/24-216F	DCMM37PHNM-A101
M24308/24-216P	DCMM37PHNM-F225
M24308/24-217Z	DDMM50PHNM
M24308/24-217F	DDMM50PHNM-A101
M24308/24-217P	DDMM50PHNM-F225
M24308/24-219Z	DEMM9PXNM
M24308/24-219F	DEMM9PXNM-A101
M24308/24-219P	DEMM9PXNM-F225
M24308/24-220Z	DAMM15PXNM
M24308/24-220F	DAMM15PXNM-A101
M24308/24-220P	DAMM15PXNM-F225
M24308/24-221Z	DBMM25PXNM
M24308/24-221F	DBMM25PXNM-A101
M24308/24-221P	DBMM25PXNM-F225
M24308/24-222Z	DCMM37PXNM
M24308/24-222F	DCMM37PXNM-A101
M24308/24-222P	DCMM37PXNM-F225
M24308/24-223Z	DDMM50PXNM
M24308/24-223F	DDMM50PXNM-A101
M24308/24-223P	DDMM50PXNM-F225
M24308/24-225Z	DEMM9PDNM
M24308/24-225F	DEMM9PDNM-A101
M24308/24-226Z	DAMM15PDNM
M24308/24-226F	DAMM15PDNM-A101
M24308/24-227Z	DBMM25PDNM
M24308/24-227F	DBMM25PDNM-A101

Gov't Designation	ITT Part Number
M24308/24-228Z	DCMM37PDNM
M24308/24-228F	DCMM37PDNM-A101
M24308/24-229Z	DDMM50PDNM
M24308/24-229F	DDMM50PDNM-A101
M24308/24-231Z	DEMM9PLNM
M24308/24-231F	DEMM9PLNM-A101
M24308/24-232Z	DAMM15PLNM
M24308/24-232F	DAMM15PLNM-A101
M24308/24-233Z	DBMM25PLNM
M24308/24-233F	DBMM25PLNM-A101
M24308/24-234Z	DCMM37PLNM
M24308/24-234F	DCMM37PLNM-A101
M24308/24-235Z	DDMM50PLNM
M24308/24-235F	DDMM50PLNM-A101
M24308/24-237Z	DEMM9PANM
M24308/24-237F	DEMM9PANM-A101
M24308/24-238Z	DAMM15PANM
M24308/24-238F	DAMM15PANM-A101
M24308/24-239Z	DBMM25PANM
M24308/24-239F	DBMM25PANM-A101
M24308/24-240Z	DCMM37PANM
M24308/24-240F	DCMM37PANM-A101
M24308/24-241Z	DDMM50PANM
M24308/24-241F	DDMM50PANM-A101
M24308/24-243Z	DEMM9PGNM
M24308/24-243F	DEMM9PGNM-A101
M24308/24-244Z	DAMM15PGNM
M24308/24-244F	DAMM15PGNM-A101
M24308/24-245Z	DBMM25PGNM
M24308/24-245F	DBMM25PGNM-A101
M24308/24-246Z	DCMM37PGNM
M24308/24-246F	DCMM37PGNM-A101
M24308/24-247Z	DDMM50PGNM
M24308/24-247F	DDMM50PGNM-A101
M24308/24-249Z	DEMM9PSNM
M24308/24-249F	DEMM9PSNM-A101
M24308/24-250Z	DAMM15PSNM
M24308/24-250F	DAMM15PSNM-A101
M24308/24-251Z	DBMM25PSNM
M24308/24-251F	DBMM25PSNM-A101
M24308/24-252Z	DCMM37PSNM
M24308/24-252F	DCMM37PSNM-A101
M24308/24-253Z	DDMM50PSNM
M24308/24-253F	DDMM50PSNM-A101
M24308/24-255Z	DEMM9PWNM
M24308/24-255F	DEMM9PWNM-A101
M24308/24-256Z	DAMM15PWNM
M24308/24-256F	DAMM15PWNM-A101
M24308/24-257Z	DBMM25PWNM
M24308/24-257F	DBMM25PWNM-A101
M24308/24-258Z	DCMM37PWNM
M24308/24-258F	DCMM37PWNM-A101
M24308/24-259Z	DDMM50PWNM
M24308/24-259F	DDMM50PWNM-A101
M24308/24-261Z	DEMAM15PMNM
M24308/24-261F	DEMAM15PMNM-A101
M24308/24-261P	DEMAM15PMNM-F225
M24308/24-262Z	DAMAM25PMNM
M24308/24-262F	DAMAM25PMNM-A101

Gov't Designation	ITT Part Number
M24308/24-262P	DAMAM25PMNM-F225
M24308/24-263Z	DBMAM44PMNM
M24308/24-263F	DBMAM44PMNM-A101
M24308/24-263P	DBMAM44PMNM-F225
M24308/24-264Z	DCMAM62PMNM
M24308/24-264F	DCMAM62PMNM-A101
M24308/24-264P	DCMAM62PMNM-F225
M24308/24-265Z	DDMAM78PMNM
M24308/24-265F	DDMAM78PMNM-A101
M24308/24-265P	DDMAM78PMNM-F225
M24308/24-267Z	DEMAM15PQNM
M24308/24-267F	DEMAM15PQNM-A101
M24308/24-267P	DEMAM15PQNM-F225
M24308/24-268Z	DAMAM25PQNM
M24308/24-268F	DAMAM25PQNM-A101
M24308/24-268P	DAMAM25PQNM-F225
M24308/24-269Z	DBMAM44PQNM
M24308/24-269F	DBMAM44PQNM-A101
M24308/24-269P	DBMAM44PQNM-F225
M24308/24-270Z	DCMAM62PQNM
M24308/24-270F	DCMAM62PQNM-A101
M24308/24-270P	DCMAM62PQNM-F225
M24308/24-271Z	DDMAM78PQNM
M24308/24-271F	DDMAM78PQNM-A101
M24308/24-271P	DDMAM78PQNM-F225
M24308/24-273Z	DEMAM15PANM
M24308/24-273F	DEMAM15PANM-A101
M24308/24-274Z	DAMAM25PANM
M24308/24-274F	DAMAM25PANM-A101
M24308/24-275Z	DBMAM44PANM
M24308/24-275F	DBMAM44PANM-A101
M24308/24-276Z	DCMAM62PANM
M24308/24-276F	DCMAM62PANM-A101
M24308/24-277Z	DDMAM78PANM
M24308/24-277F	DDMAM78PANM-A101
M24308/26-1	D20418-128
M24308/26-1F	D20418-2
M24308/26-2	D20418-129
M24308/26-2F	D20418-39

D Sub



Dimensions shown in inches (mm)  
Specifications and dimensions subject to change



S-311-P Specification	ITT Part Number
311P10-1P-B-12	DEM-9P-NMB-K52
311P10-1P-C-12	DEM-9P-NMC-K52
311p10-1S-B-12	DEM-9S-NMB-K52
311P10-1S-C-12	DEM-9S-NMC-K52
311P10-2P-C-12	DAM-15P-NMC-K52
311P10-2S-B-12	DAM-15S-NMB-K52
311P10-2S-C-12	DAM-15S-NMC-K52
311P10-3P-B-12	DBM-25P-NMB-K52
311P10-3P-C-12	DBM-25P-NMC-K52
311P10-3S-B-12	DBM-25S-NMB-K52
311P10-3S-C-12	DBM-26S-NMC-K52
311P10-4P-B-12	DCM-37P-NMB-K52
311P10-4P-C-12	DCM-37P-NMC-K52
311P10-4S-B-12	DCM-37S-NMB-K52
311P10-4S-C-12	DCM-37S-NMC-K52
311P10-5P-B-12	DDM-50P-NMB-K52
311P10-5P-C-12	DDM-50P-NMC-K52
311P10-5S-B-12	DDM-50S-NMB-K52
311P10-5S-C-12	DDM-50S-NMC-K52
311P10-6P-B-12	DEM-5W1P-NMB-K52
311P10-6P-C-12	DEM-5W1P-NMC-K52
311P10-6S-B-12	DEM-5W1S-NMB-K52
311P10-6S-C-12	DEM-5W1S-NMC-K52
311P10-7P-B-12	DAM-3W3P-NMB-K52
311P10-7P-C-12	DAM-3W3P-NMC-K52
311P10-7S-B-12	DAM-3W3S-NMB-K52
311P10-7S-C-12	DAM-3W3S-NMC-K52
311P10-8P-B-12	DAM-7W2P-NMB-K52
311P10-8P-C-12	DAM-7W2P-NMC-K52
311P10-8S-B-12	DAM-7W2S-NMB-K52
311P10-8S-C-12	DAM-7W2S-NMC-K52
311P10-9P-B-12	DAM-11W1P-NMB-K52
311P10-9P-C-12	DAM-11W1P-NMC-K52
311P10-9S-B-12	DAM-11W1S-NMB-K52
311P10-9S-C-12	DAM-11W1S-NMC-K52
311P10-10P-B-12	DBM-5W5P-NMB-K52
311P10-10P-C-12	DBM-5W5P-NMC-K52
311P10-10S-B-12	DBM-5W5S-NMB-K52
311P10-10S-C-12	DBM-5W5S-NMC-K52
311P10-11P-B-12	DBM-9W4P-NMB-K52
311P10-11P-C-12	DBM-9W4P-NMC-K52
311P10-11S-B-12	DBM-9W4S-NMB-K52
311P10-11S-C-12	DBM-9W4S-NMC-K52
311P10-12P-B-12	DBM-13W3P-NMB-K52
311P10-12P-C-12	DBM-13W3P-NMC-K52
311P10-12S-B-12	DBM-13W3S-NMB-K52
311P10-12S-C-12	DBM-13W3S-NMC-K52
311P10-13P-B-12	DBM-17W2P-NMB-K52
311P10-13P-C-12	DBM-17W3P-NMC-K52
311P10-13S-B-12	DBM-17W2S-NMB-K52
311P10-13S-C-12	DBM-13W3S-NMC-K52

S-311-P Specification	ITT Part Number
311P10-14P-B-12	DBM-21W1P-NMB-K52
311P10-14P-C-12	DBM-21W1P-NMC-K52
311P10-14S-B-12	DBM-21W1S-NMB-K52
311P10-14S-C-12	DBM-21W1S-NMC-K52
311P10-15P-B-12	DCM-8W8P-NMB-K52
311P10-15P-C-12	DCM-8W8P-NMC-K52
311P10-15S-B-12	DCM-8W8S-NMB-K52
311P10-15S-C-12	DCM-8W8S-NMC-K52
311P10-16P-B-12	DCM-13W6P-NMB-K52
311P10-16P-C-12	DCM-13W6P-NMC-K52
311P10-16S-B-12	DCM-13W6S-NMB-K52
311P10-16S-C-12	DCM-13W6S-NMC-K52
311P10-17P-B-12	DCM-17W5P-NMB-K52
311P10-17P-C-12	DCM-17W5P-NMC-K52
311P10-17S-C-12	DCM-17W5S-NMC-K52
311P10-18P-B-12	DCM-21WA4P-NMB-K52
311P10-18P-C-12	DCM-21WA4P-NMC-K52
311P10-18S-B-12	DCM-21WA4S-NMB-K52
311P10-18S-C-12	DCM-21WA4S-NMC-K52
311P10-23P-B-12	DDM-36W4P-NMB-K52
311P10-23P-C-12	DDM-36W4S-NMC-K52
311P10-23S-B-12	DDM-36W4S-NMB-K52
311P10-23S-C-12	DDM-36W4S-NMC-K52
311P10-24P-B-12	DDM-43W2P-NMB-K52
311P10-24P-C-12	DDM-43W2S-NMC-K52
311P10-24S-B-12	DDM-43W2S-NMB-K52
311P10-24S-C-12	DDM-43W2S-NMC-K52
311P10-25P-B-12	DDM-47W1P-NMB-K52
311P10-25P-C-12	DDM-47W1P-NMC-K52
311P10-25S-B-12	DDM-47W1S-NMB-K52
311P10-25S-C-12	DDM-47W1S-NMC-K52
311P10-23P-B-12	DDM-36W4P-NMB-K52
311P10-23P-C-12	DDM-36W4S-NMC-K52
311P10-23S-B-12	DDM-36W4S-NMB-K52
311P10-23S-C-12	DDM-36W4S-NMC-K52
311P10-24P-B-12	DDM-43W2P-NMB-K52
311P10-24P-C-12	DDM-43W2S-NMC-K52
311P10-24S-B-12	DDM-43W2S-NMB-K52
311P10-24S-C-12	DDM-43W2S-NMC-K52
311P10-25P-B-12	DDM-47W1P-NMB-K52
311P10-25P-C-12	DDM-47W1P-NMC-K52
311P10-25S-B-12	DDM-47W1S-NMB-K52
311P10-25S-C-12	DDM-47W1S-NMC-K52
311P405-9P-B-12	DAA-11W1P-NMB-K52
311P405-9S-B-12	DAA-11W1S-NMB-K52
311P405-10P-B-12	DAM-5W5P-NMB-K52
311P405-10S-B-12	DAM-5W5S-NMB-K52
311P405-11P-B-12	DAM-9W4P-NMB-K52
311P405-12P-B-12	DBA-13W3P-NMB-K52
311P405-12S-B-12	DBA-13W3S-NMB-K52
311P405-13P-B-12	DBMA-17W2P-NMB-K52

S-311-P Specification	ITT Part Number
311P405-13S-B-12	DBMA-17W2S-NMB-K52
311P405-14P-B-12	DCA-21W1P-NMB-K52
311P405-15P-B-12	DCM-8W8P-NMB-K52
311P405-15S-B-12	DCM-8W8S-NMB-K52
311P405-18P-B-12	DCA-21W1P-NMB-K52
311P405-18S-B-12	DCA-21WA1S-NMB-K52
311P405-24S-B-12	DDA-43W2S-NMB-K52
311P407-1P-B-12	DEMA-15P-NMB-K47FO
311P407-1S-B-12	DEMA-15S-NMB-K47FO
311P407-2P-B-12	DAMA-26P-NMB-K47FO
311P407-2S-B-12	DAMA-26S-NMB-K47FO
311P407-3P-B-12	DBMA-44P-NMB-K47FO
311P407-3S-B-12	DBMA-44S-NMB-K47FO
311P407-4P-B-12	DCMA-62P-NMB-K47FO
311P407-4S-B-12	DCMA-62S-NMB-K47FO
311P407-5P-B-12	DDMA-78P-NMB-K47FO
311P407-5S-B-12	DDMA-78S-NMB-K47FO
311P409-1P-B-12	DEMA-9P-NMB-K47FO
311P409-1S-B-12	DEMA-9S-NMB-K47FO
311P409-2P-B-12	DAMA-15P-NMB-K47FO
311P409-2S-B-12	DAMA-15S-NMB-K47FO
311P409-3P-B-12	DBMA-25P-NMB-K47FO
311P409-3S-B-12	DBMA-25S-NMB-K47FO
311P409-4P-B-12	DCMA-37-NMB-K47FO
311P409-4S-B-12	DCMA-37S-NMB-K47FO
311P409-5P-B-12	DDMA-50P-NMB-K47FO
311P409-5S-B-12	DDMA-50S-NMB-K47FO
G08P1	030-2042-002
G08S1	031-1147-002
G10P1	330-5291-037
G10S1	031-1007-052
GCP1	DM53740-17
GCP2	DM53740-15
GCP3	DM53740-16
GCP4	DM53740-18
GCRP1	DM53741-12
GCRP2	DM53741-11
GCRP3	DM53741-10
GCRP4	DM53741-13
GCS1	DM53742-18
GCS2	DM53742-16
GCS3	DM53742-17
GCS4	DM53742-19
GCSR1	DM43743-18
GCSR2	DM43743-16
GCSR3	DM43743-17
GCSR4	DM43743-19
GHP6	DM51157-8
GHRP6	DM51157-5005
GHRS6	DM51155-5004
GHS6	DM51155-7

Dimensions shown in inches (mm)  
 Specifications and dimensions subject to change

