

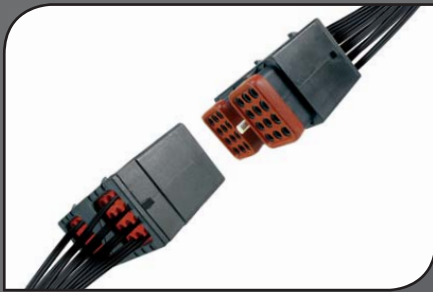

# DEUTSCH

I N D U S T R I A L





# Deutsch Distributors

## AUSTRALIA:

### **Electro Power & Data Equipment**

2 Michaels Drive  
Alfredton, Vic 3350  
Australia  
Tel: +61 3 5332 0222  
[www.epde.com.au](http://www.epde.com.au)

## BRAZIL:

### **Cantwell Cullen & Company**

Av.Cotovia, 124, Apto 103  
Moema, São Paulo 0451/-000  
Tel: +55 11 2537-5745

## CANADA:

### **Cantwell Cullen & Company**

Toronto Office  
1131 South Service Road West  
Oakville, Ontario L6L 6K4  
Tel: 1-905-825-3255

## CHINA:

### **Deutsch Connectors Trading Co.**

Rm #1032, 10F Central Plaza  
381 Huai Hai Zhong Road  
Shanghai 200020, China  
Tel: +86 21 66082211  
[www.deutschipd-china.com](http://www.deutschipd-china.com)

## FRANCE:

### **CDD**

Aeroparc Saint-Martin du  
Touch  
12 rue de Caulet - Cellule B07  
31300 Toulouse  
Tel: +(33) 5 34 26 53 50

## EUROPE & GERMANY:

### **Deutsch Industrial Europe**

Fraunhoferstraße 11B  
Martinsried  
Germany, D-82152  
Tel: +49-89-899157-0

## INDIA:

### **Deutsch India Power Connectors Pvt. Ltd.**

#104, Prestige Omega,  
EPIP Zone  
1st Phase, Whitefield,  
Bangalore - 560 066 INDIA  
Tel: +91 80 404 66 501

## ISRAEL:

### **Deutsch Israel Ltd.**

31 Hutzot Hayotzer Street  
Southern Industrial Zone  
P.O.B. 5082  
Ashkelon, Israel 78 150  
Tel: +972-8-671-9020

## ITALY:

### **Deutsch Italia SRL**

Viale E. Jenner, 51  
I - 20159 Milano  
Tel: 00390 2 39322240

## JAPAN:

### **Deutsch Japan Limited**

4-3-28 Nishidai  
Itabashi-ku, Tokyo 175-0045  
Japan  
Tel: +81-3-5922-1345  
[www.nihon-deutsch.co.jp](http://www.nihon-deutsch.co.jp)

## MEXICO:

### **ATM Sealed Connectors S de RL de CV**

2722-3 Barlovento  
Colonia Residencial Victoria  
Guadalajara, Jalisco 44538  
Mexico  
Tel: +52-33-3623-0450

## SINGAPORE:

### **Hellermann Tyton Pte. Ltd.**

545, Yishun Industrial Park A  
Yishun Ave., 7  
Singapore, 768741  
Tel: +65 6852 8585/93  
[www.hellermannntyton.com.sg](http://www.hellermannntyton.com.sg)

## SOUTH AFRICA:

### **Hellermann Tyton**

34 Milky Way Avenue  
Linbro Industrial Park  
Johannesburg  
2065 South Africa  
Tel: 011 8796600

## SOUTH KOREA:

### **Nova Corporation**

B-905, Keumkang  
Peneterium 333-7  
Sangdaewon-Dong  
Jungwon-gu, Seongnam-Si  
Gyeonggi-do, 462-807  
South Korea  
Tel: 82-31-730-0160  
[www.novakorea.net](http://www.novakorea.net)

## TAIWAN:

### **Deutsch Asian Pacific Operations**

Weiting Hsin  
18F-1, N. 606, Jung Yi Road,  
Sec. 2 Taichung, 408  
Taiwan, R.O.C.  
Tel: +886 4 2258 5616

## UNITED KINGDOM:

### **Deutsch UK**

Castleham Industrial Estate  
4 Stainer Road  
St. Leonards on Sea  
East Sussex, TN38 9RF  
Tel: +44 (0)1424 852721

## UNITED STATES & CANADA:

### **LADD Industries**

4849 Hempstead Station Dr.  
Kettering, OH 45429  
Tel: 800-223-1236  
[www.laddinc.com](http://www.laddinc.com)





# Table of Contents

## General Information

About Deutsch	2
Deutsch Connector Series Overview	8
Features & Benefits	3
Introduction to Connectors	4
Technical Specifications	6

## Products

AEC Series	95
Bussing Options	37
Common Contacts	119
Controller Area Networks	43
Diodes & Resistors	33
DRB Series	67
DRC Series	61
DT Family	17
HD10 Series	73

## Additional Resources

Modification List	148
Standards	150
Glossary	151
Index	157
HD30 & HDP20 Series	79
IMC Series	113
Printed Circuit Board Connectors	49
Quick Connect Series	107
Single Terminal	13
STRIKE Series	99
Tooling	135
WT Series	91

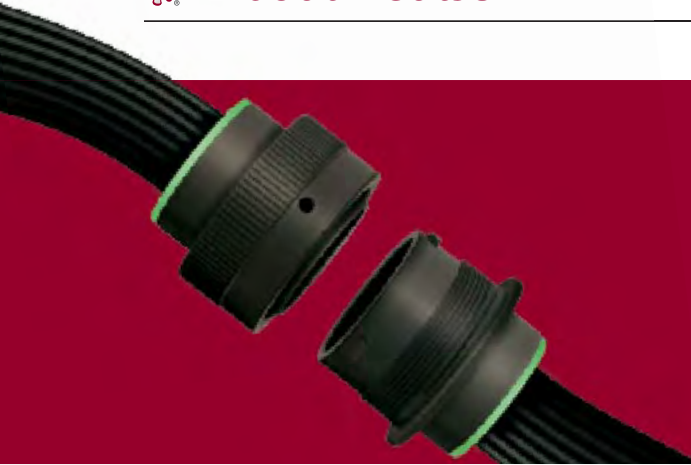

# About Deutsch

Deutsch takes pride in the development of reliable products for use in harsh environment conditions. Since its creation in 1938, Deutsch Corporation's innovative solutions have contributed greatly to the success of major equipment programs. Deutsch has always been a leader in product innovations. A few of the earliest Deutsch firsts include:

- 1955- Environment resistant "miniature" connector
- 1956- Push-pull quick disconnect coupling system
- 1957- Injection molding of neoprene inserts
- 1959- Insertable/removable crimp type contacts
- 1959- Hermetically sealed single compression glass insert
- 1960- Cold headed contacts

- 1961- Size 22, subminiature closed entry socket contact
- 1970- Liquid molding of silicone
- 1972- Individual contact release retention system for size 22 contacts
- 1984- Composite cylindrical connector shells



Deutsch Industrial was founded in 1976 to serve the industrial and heavy duty markets with a wide variety of electrical connectors. Deutsch is a key player in building connector systems and components for high performance machinery such as off-road equipment, tractors and agricultural machinery, the heavy duty truck market, and several types of recreational equipment such as boats, motorcycles, and RVs.

In the 1960's Deutsch was a pioneer in quality control, and it still holds true today with Deutsch taking all the necessary steps to assure that each of its products consistently meet or exceed customer expectations. Working in close collaboration with its customers' research and development departments, Deutsch provides solutions for many technological challenges.

Circling the globe, from California to Tennessee, from France and the United Kingdom to Spain and Italy, from India to China, Deutsch is here for its customers. This vital link between Deutsch and its customer base is essential in developing tomorrow's connecting technology.







# Features & Benefits

Deutsch connectors are ideal where dust, dirt, moisture, salt spray, and vibration can contaminate or damage electrical connections.

## ■ Deutsch Features

---

- Common contacts- a small number of contacts terminates multiple Deutsch connectors.
- Maximum current rating- majority of the contacts do not require a derating curve to determine proper application.
- Common tooling- hand crimp tools, automated or semi-automated tooling are available for solid or stamped & formed contacts.
- Environmental seal- will handle extreme applications.
- Gas tight crimp terminations- when properly crimped, provide a gas tight crimp which is highly resistant to increases in resistance as a result of temperature and oxidation.
- High performance molded shells- impact resistant and fire retardant.
- Redundant silicone seals- many connectors feature integral components that reduce wire termination assembly time and cost.
- Hand insertable/removable contacts- no special contact insertion tools and simplified service.
- Keying options- prevents mismatching in multiple connector applications.
- No contact retention "tangs."
- Extended wire sealing ranges.

## ■ Deutsch Benefits

---

- Easy to use
- Minimized warranty claims
- Added customer value
- Lower tooling costs
- Minimized electrical failures
- Eliminate mismatching
- Reduced assembly time
- Simplified field service
- Decreased down time
- Reduced repair time
- Increased product confidence
- Reduced repair expense
- Lower inventory cost
- Increased reliability



# Introduction to Connectors

Deutsch Industrial has been providing high-quality environmentally sealed electrical connectors for harsh environments for more than 35 years. Developed with simplicity of design and ease of use in mind, Deutsch connectors offer a variety of innovative solutions to suit any application. Whether it's for a new application or a retrofit, using a Deutsch connector provides simplified design and wiring, fewer warranty claims, and easy field repairs.

Deutsch's rugged all-metal bodies and corrosion resistant thermoplastic shells are manufactured from high quality materials selected for their ability to withstand years of environmental exposure. Deutsch connectors are available in rectangular and cylindrical body shapes and feature:

- Wide operating temperature range
- Secure locking mechanisms
- Positive contact retention system

Because Deutsch connectors are designed to mate securely with minimal force, assembly time is reduced and field service is easy. The high-performance molded shells are shock and vibration resistant, and field proven for long service life.



*Rugged, durable housing options include metal and thermoplastic*



*Silicone seal at connector interface prevents contamination*

Deutsch silicone seals and grommets fit tightly around the wire insulation and at the connector interface to provide redundant barriers to contamination. In order to create a reliable environmental seal and ensure continuity of flow, Deutsch seals:

- Are resistant to most common industrial and engine fluids
- Retain their flexibility across a wide temperature range
- Never require potting or dielectric grease

With integrated seals that are designed to work with multiple wire gauges, Deutsch connectors simplify design and inventory management, and provide exceptional performance in critical environments.

The Deutsch Industrial Common Contact System is a unique system of interchangeable and intermateable contacts that can be used in many Deutsch Industrial connectors. Contacts are available in solid or stamped & formed styles, with plating options including gold, nickel, and tin. Easy-to-use indent crimpers create a gas tight crimp that is resistant to oxidation. This high-quality crimp allows Deutsch contacts to provide reliable, low-resistance power and data transmission.



*Cross section of stamped & formed and solid gas tight contact crimps*

With the wide variety of Deutsch connectors available, it is the consistency of design among the connector series that streamlines production and field service. Deutsch connectors share several common elements that simplify assembly:

- Integral wire seals and grommets
- Clearly marked contact positions
- Common contacts and tooling
- Indexed connector bodies to prevent mis-mating

Since most Deutsch series use the same processes, contacts, and tooling, time spent training is reduced and production is streamlined and simplified. This consistency in production creates a higher quality end product with less down time and fewer warranty claims.

No matter the environment, Deutsch Industrial connectors provide the innovative solutions demanded by harsh conditions. Deutsch Industrial's dedication to quality and innovation has created a unique system of easy-to-use connectors to simplify your processes from start to finish.

Deutsch Features
Common Contacts Common Tooling Common Process
Assembly Features
Plug & play "Blind" mating Keying options

Deutsch Connectors Feature:
• Gas tight crimp termination
• High performance molded shells
• Redundant silicone seals
• Hand insertable/removable contacts



## Technical Specifications

### ■ Performance Specifications

Deutsch Industrial takes great pride in designing and manufacturing superior environmentally sealed electrical connectors. Deutsch electrical connectors will stand up to the harsh environmental challenges that are common to industrial markets that require advanced performance. Deutsch can only warrant electrical performance when proper parts, procedures, and tooling are used.

#### Temperature

Operating at temperatures from -55° C to +125° C continuous at rated current.

- DTMH Series and Quick Connect Series: -55° C to +150° C
- IMC Series and WT Series: -55° C to +175° C

#### Durability

No electrical or mechanical defects after 100 cycles of engagement and disengagement.

#### Vibration

No unlocking or unmating and exhibits no mechanical or physical damage after sinusoidal vibration levels of 20 G's at 10 to 2000 Hz in each of the three mutually perpendicular planes. No electrical discontinuities longer than 1 microsecond.

#### Physical Shock

No unlocking, unmating, or other unsatisfactory result during or after 50 G's in each of three mutually perpendicular planes. No electrical discontinuities longer than 1 microsecond. MIL-STD 202, Method 213, Condition "C".

#### Fluid Resistance

Connectors show no damage when exposed to most fluids used in industrial applications.

#### Insulation Resistance

1000 megohms minimum at 25° C.

#### Moisture Resistance

Properly wired and mated connections will withstand immersion under three feet of water without loss of electronic qualities or leakage.

- WT Series withstands immersion under four feet of water
- IMC & Quick Connect Series: IP68
- Moisture resistance does not apply to DTMN Series

#### Dielectric Withstanding Voltage

Current leakage less than 2 milliamps at 1500 VAC.

#### Thermal Cycle

No cracking, chipping or leaking after 20 test cycles from -55° C to +125° C.

#### Voltage (IMC & Quick Connect Series only)

Up to 1000 VAC (rms)

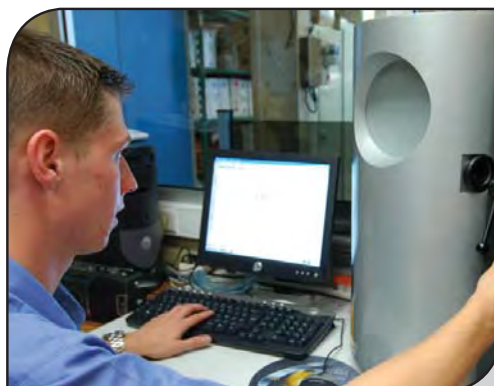

## ■ Material Specifications

### AEC Series

Grommet: Silicone rubber  
 Jackscrew: Steel  
 Plug Threaded Inserts: Steel  
 Shell: Thermoplastic

### Contacts

Pin & Socket: Copper alloy  
 Finish: Nickel plating  
 Optional: Gold plating

### DRB Series

Flange Body: Thermoplastic  
 Flange Clip: Steel  
 Grommet: Silicone rubber  
 Jackscrew: Steel  
 Receptacle Threaded Inserts: Steel  
 Shell: Thermoplastic  
 Wedgelocks: Thermoplastic

### DRC Series

Grommet: Silicone rubber  
 Insert Retainer: Thermoplastic  
 Jackscrew: Steel  
 Receptacle Threaded Inserts: Steel/Brass  
 Shell: Thermoplastic

### DT Family (DT, DTM, DTMH, DTP, DTV)

Grommet: Silicone rubber  
 Insert Retainer: Thermoplastic  
 Receptacle Interfacial Seal: Silicone rubber  
 Shell: Thermoplastic  
 Wedgelocks: Thermoplastic

### DTHD Series

Grommet: Silicone rubber  
 Shell: Thermoplastic

### HD10 Series

Grommet: Silicone rubber  
 Insert Retainer: Thermoplastic  
 Receptacle Interfacial Seal: Silicone rubber  
 Shell: Thermoplastic

### HDP20 Series

Grommet: Silicone rubber  
 Insert Retainer: Thermoplastic  
 Plug Coupling Ring: Thermoplastic  
 Shell: Thermoplastic

### HD30 Series

Grommet: Silicone rubber  
 Insert Retainer: Thermoplastic  
 Plug Coupling Ring: Aluminum  
 Shell: Aluminum

### IMC Series

Flange Seal: Nitrile  
 Insert Retainer: Ultem®  
 O-ring Seal: Nitrile  
 Plug Coupling Ring: Ultem®  
 Shell: Ultem®

### Quick Connect Series

Grommet: Silicone rubber  
 Insert Retainer: Ultem®  
 O-ring Seal: Viton  
 Shell: Ultem®

### STRIKE Series

Flange Seal: Silicone rubber  
 Plug Grommet: Silicone rubber  
 Receptacle Threaded Inserts: Brass  
 Shell: Thermoplastic  
 TPA: Thermoplastic

### WT Series

Grommet: Silicone rubber  
 Shell: Anodized aluminum or composite





## Connector Overview

All Deutsch connectors are designed for harsh environments where dust, dirt, moisture, and vibration can damage electrical connections. Deutsch Industrial offers a comprehensive product line that features connector options to meet a myriad of design requirements. Cavity arrangements are available from 1 to 128 cavities, and wire gauges from 26 AWG up to 3/0 AWG. Deutsch connectors offer different shapes, latching mechanisms, mounting styles, and materials to meet diverse application requirements and all Deutsch product lines offer accessories to further expand the series flexibility.

### ■ AEC Series

Key Features:

- Accepts contact size 16 (13 amps)
- 14-20 AWG
- 40 cavity arrangement
- In-line or PCB mount
- Square thermoplastic housing
- Jackscrew for mating



### ■ DRB Series

Key Features:

- Accepts contact sizes 4 (100 amps), 8 (60 amps), 12 (25 amps), 16 (13 amps), and 20 (7.5 amps)
- 6-22 AWG
- 48, 60, 102, and 128 cavity arrangements
- Flange mount
- Rectangular, thermoplastic housing
- Jackscrew for mating
- Wedgelocks assure contact alignment and retention



### ■ DRC Series

Key Features:

- Accepts contact sizes 16 (13 amps) and 20 (7.5 amps)
- 14-22 AWG
- 24, 38, 40, 50, 60, 64, 70, and 80 cavity arrangements
- In-line, flange, or PCB mount
- Rectangular, thermoplastic housing
- Jackscrew for mating





## ■ DTHD Series

---

### Key Features:

- Accepts contact sizes 4 (100 amps), 8 (60 amps), and 12 (25 amps)
- 6-14 AWG
- 1 cavity arrangement
- In-line or flange mount
- Circular, thermoplastic housing
- Integrated latch for mating



## ■ DT Series

---

### Key Features:

- Accepts contact size 16 (13 amps)
- 14-20 AWG
- 2, 3, 4, 6, 8, and 12 cavity arrangements
- In-line, flange, or PCB mount
- Rectangular, thermoplastic housing
- Integrated latch for mating
- Wedgelocks assure contact alignment and retention



## ■ DTM Series

---

### Key Features:

- Accepts contact size 20 (7.5 amps)
- 16-22 AWG
- 2, 3, 4, 6, 8, and 12 cavity arrangements
- In-line, flange, or PCB mount
- Rectangular, thermoplastic housing
- Integrated latch for mating
- Wedgelocks assure contact alignment and retention



## ■ DTP Series

---

### Key Features:

- Accepts contact size 12 (25 amps)
- 10-14 AWG
- 2 and 4 cavity arrangements
- In-line, flange, or PCB mount
- Rectangular, thermoplastic housing
- Integrated latch for mating
- Wedgelocks assure contact alignment and retention







## ■ DTV Series

### Key Features:

- Accepts contact size 16 (13 amps)
- 14-20 AWG
- 18 cavity arrangement
- Flange mount
- Rectangular, thermoplastic housing
- Integrated latch for mating
- Wedgelocks assure contact alignment and retention



## ■ HD10 Series

### Key Features:

- Accepts contact sizes 4 (100 amps), 12 (25 amps), and 16 (13 amps)
- 6-20 AWG
- 3, 4, 5, 6, and 9 cavity arrangements
- In-line, flange, or PCB mount
- Circular, thermoplastic housing
- Coupling ring for mating



## ■ HD30 Series

### Key Features:

- Accepts contact sizes 4 (100 amps), 8 (60 amps), 12 (25 amps), 16 (13 amps), and 20 (7.5 amps)
- 6-22 AWG
- 2, 6, 7, 8, 9, 14, 16, 18, 19, 20, 21, 23, 29, 31, 33, 35, and 47 cavity arrangements
- In-line or flange mount
- Circular, aluminum housing
- Coupling ring for mating



## ■ HDP20 Series

### Key Features:

- Accepts contact sizes 4 (100 amps), 8 (60 amps), 12 (25 amps), 16 (13 amps), and 20 (7.5 amps)
- 4-22 AWG
- 2, 6, 7, 8, 9, 14, 16, 18, 19, 20, 21, 23, 29, 31, 33, 35, and 47 cavity arrangements
- In-line or flange mount
- Circular, thermoplastic housing
- Coupling ring for mating



## ■ IMC Series

### Key Features:

- Accepts contact sizes 16 (13 amps), 20 (7.5 amps), and 22 (5 amps)
- 16-26 AWG
- 2, 3, 4, 5, 7, and 12 cavity arrangements
- In-line or flange mount
- Circular, Ultem® housing
- Coupling ring for mating



## ■ Quick Connect Series

### Key Features:

- Accepts contact sizes 16 (13 amps), 20 (7.5 amps), and 22 (5 amps)
- 16-26 AWG
- 2, 7, and 12 cavity arrangements
- In-line or flange mount
- Circular, Ultem® housing
- Push button mechanism for mating



## ■ STRIKE Series

### Key Features:

- Accepts contact sizes Ø12mm (300 amps), Ø8mm (150 amps), 12 (25 amps), 16 (13 amps), and 20 (7.5 amps)
- 3/0-20 AWG
- 1, 4, 8, 18, 32, 36, 50, and 64 cavity arrangements
- In-line, flange, or PCB mount
- Square, thermoplastic housing
- Lever for mating
- TPA assures contact alignment and retention



## ■ WT Series

### Key Features:

- Accepts contact sizes 4 (100 amps) and 16 (13 amps)
- 6, 16-20 AWG
- 3, 16, and 31 cavity arrangements
- In-line or flange mount
- Circular, anodized aluminum or composite housing
- Coupling ring for mating







# Single Terminal

## Contents

DTHD Series Overview	14
DTHD Part Numbering System	14
DTHD Dimensions	14
DTHD Special Modifications	15
DTHD Accessories	15
Jiffy Splice Overview	16
Jiffy Splice Dimensions	16
Jiffy Splice How To Instructions	16



## Single Terminal Overview

Deutsch offers two different solutions for applications that require heavy duty single terminal connections. With the DTHD Series and the Jiffy Splices, Deutsch provides environmentally sealed field-serviceable connections for the full range of wire gauges covered by the Deutsch Common Contact System. The DTHD connectors are heavy duty power terminations for in-line and mounted applications. Jiffy Splices are lightweight in-line splices for quick connections. Both options provide easy installation and service with standard Deutsch tools and contacts.

### ■ DTHD Series Overview

DTHD connectors are single terminal connectors for heavy duty applications. Easy to install, environmentally sealed and compact in size, they are a simple, field serviceable alternative to a splice. DTHD connectors are available in three sizes, carry 25 to 100 amps, and can be mounted or used in-line.



### ■ DTHD Series Part Numbering System

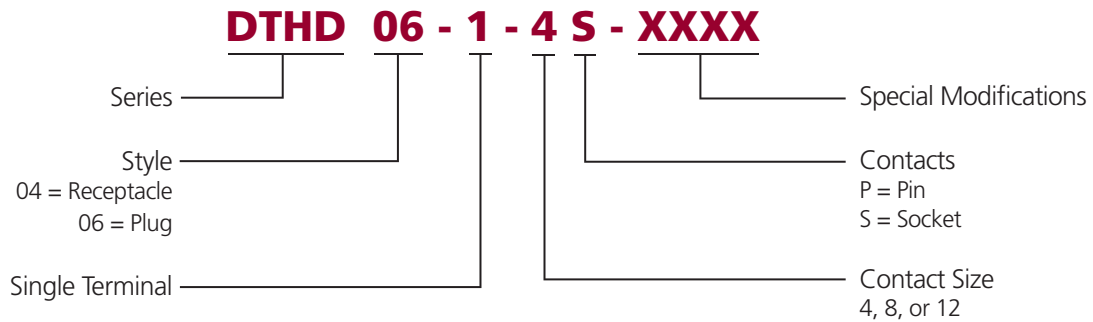

### ■ DTHD Series Dimensions



Contact Size	DTHD Plug			DTHD Receptacle		
	Overall Length A	Overall Height B	Overall Width C	Overall Length D	Overall Height E	Overall Width F
12	1.498 (38.05)	.771 (19.58)	.570 (14.48)	2.068 (52.53)	.850 (21.59)	.710 (18.08)
8	1.498 (38.05)	.861 (21.87)	.660 (16.76)	2.068 (52.53)	.940 (23.88)	.800 (20.32)
4	1.498 (38.05)	1.076 (27.33)	.875 (22.23)	2.068 (52.53)	1.170 (29.72)	1.045 (26.54)

Dimensions are for reference only.

## Special Modifications

The DTHD Series connectors offer modifications to enhance the design flexibility and meet application specific needs. Options include end caps and flanges.

### ■ E003 Modification

The E003 is an end cap modification. The end cap is a protective cap that is sonically welded to the rear of the connector to provide extra assurance.



### ■ L013 and L009 Modification

The L013 and L009 are sealed flange modifications. The L013 offers outside mounting and the L009 offers inside mounting.



L009



L013

## Accessories

There is a full line of mounting clips available for use with the DTHD Series. The mounting clips offer straight or side mounting and several material options. The mounting clips are designed to be used on all DTHD receptacles.

Mounting Clip	Part Number	Mounting Direction	Color/Material	Hole O.D. inches (mm)
	1027-003-1200	Straight	Stainless steel	.433 (11.0)
	1027-005-1200	Straight	Stainless steel	.512 (13.0)
	1027-004-1200	Straight	Steel w/ zinc plating	.512 (13.0)
	1027-008-1200	Side	Steel w/ zinc plating	.433 (11.0)
	1027-013-1200	Side	Steel w/ zinc plating	.323 (8.2)
	1011-026-0205	Straight	Gray plastic	.200 (5.08)
	1011-030-0205	Straight	Black plastic	---
	1011-310-0205* *Connector removeable with 50N of force	Straight	Black plastic	---



## Jiffy Splice Overview



Deutsch Jiffy Splices are a unique, field-serviceable alternative to permanent splices. Made from the same high quality silicone elastomer as Deutsch connector seals and grommets, the Jiffy Splice body houses a contact retention system that secures a mated pair of contacts in a compact environmentally sealed unit. Jiffy Splices are easy to install and service with standard Deutsch tools.

Part Number	Size	A	B (min.)	Wire AWG	Insulation O.D.
JS-04-00	4	3.437 (87.30)	.765 (19.43)	6	.280-.292 (7.11-7.42)
JS-12-00	12	2.500 (63.50)	.500 (12.70)	12-14	.134-.170 (3.40-4.32)
JS-16-00	16	2.465 (62.61)	.385 (9.78)	14-20	.100-.134 (2.54-3.40)

Dimensions are for reference only.



### Notice

Jiffy Splices accept one pin and one socket.

## How To Instructions

### Contact Insertion (after crimping)

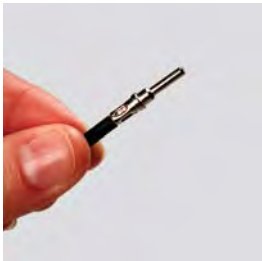

**Step 1:**  
Grasp contact approximately one inch behind the contact crimp barrel.



**Step 2:**  
Hold Jiffy Splice between thumb and forefinger approximately one half inch behind cavity.

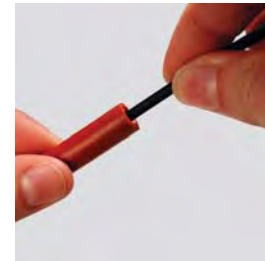

**Step 3:**  
Push contact straight into Jiffy Splice until a positive stop is felt. An audible "snap" will occur when correctly mated. A light tug will confirm it is properly seated.

### Contact Removal



**Step 1:**  
Snap appropriate size removal tool over the wire.



**Step 2:**  
Hold Jiffy Splice between thumb and forefinger approximately one half inch behind cavity. Slide tool into cavity until resistance is felt and retaining fingers are engaged. Do not twist or insert tool at an angle.

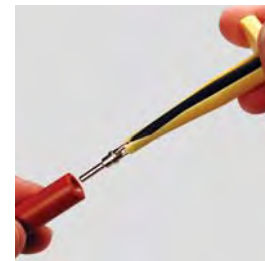

**Step 3:**  
Grip Jiffy Splice between thumb and forefinger and slowly pull contact wire assembly with removal tool out of cavity.





# DT Family

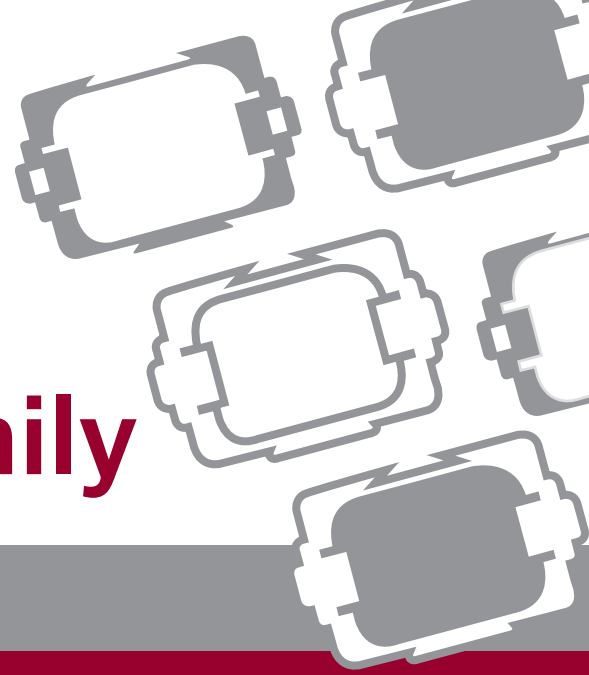

## Contents

DT Family Overview	18	DTV Series	28
Part Numbering System	18	DTMH Series	29
Dimensions	19	DTMN Series	30
Configurations	20	How To Instructions	31
Required Components	21-22		
Special Modifications	22-23		
Accessories	24-27		

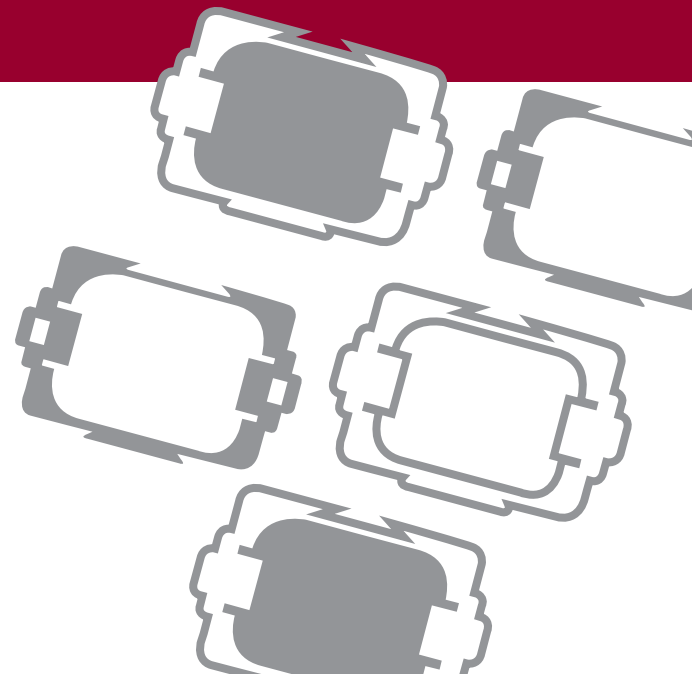

## DT Family Overview

Deutsch DT, DTM, and DTP Series environmentally sealed connectors are designed specifically for cable to cable applications. The DT connectors are used in harsh environment applications where even a small degradation in connection may be critical. Thermoplastic housings offer a wide operating temperature range and silicone rear wire and interface seals allow the connectors to withstand conditions of extreme temperature and moisture.

The connector may be populated with either solid or stamped & formed style contacts. Contact insertion and removal does not require any special tools. Contacts are retained in locked position by dielectric fingers which are molded as an integral part of the housing. Secondary wedgelocks are assembled at the mating interfaces to ensure contact positioning.

The Deutsch DT Series general purpose connectors will provide reliability and performance on the engine or transmission, under the hood, on the chassis, or in the cab.

### DT Series Overview

Deutsch's DT Series connectors offer field proven reliability and rugged quality. The DT design strengths include optional flange mounting, multi-pin arrangements, lower cost, and design flexibility. The DT Series offers the designer the ability to use multiple size 16 contacts, each with 13 amp continuous capacity, within a single shell.

### DTP Series Overview

Deutsch's DTP Series connectors are the solution for your power application requirements. Building on both the DT and DTM design strengths, the DTP connector line was developed to fill the need for higher amperage, multi-pin, inexpensive connectors.

The DTP Series offers the designer the ability to use multiple size 12 contacts, each with a 25 amp continuous capacity, within a single shell. The DTP connectors are currently available in two and four pin configurations.

### DTM Series Overview

Deutsch's DTM Series connectors are the answer to all of your smaller wire gauge applications. Building on the DT design strengths, the DTM connector line was developed to fill the need for lower amperage, multi-pin, inexpensive connectors. The DTM Series offers the designer the ability to use multiple size 20 contacts, each with 7.5 amp continuous capacity, within a single shell.



### DT Family Part Numbering System

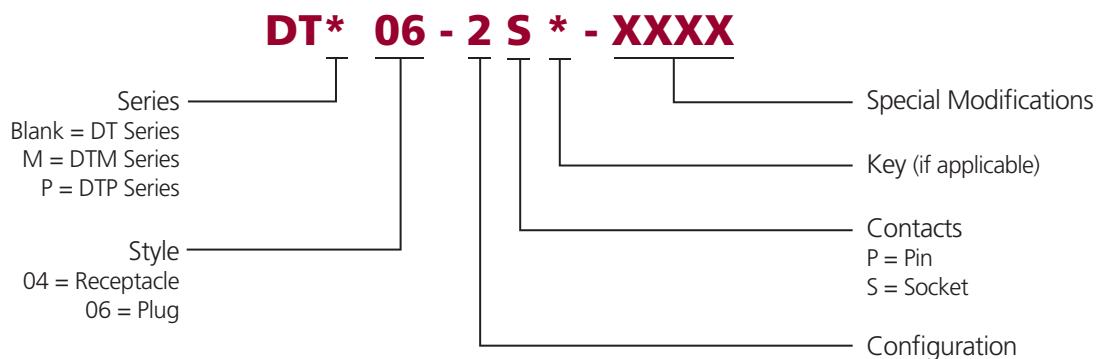

**DT Series Dimensions**

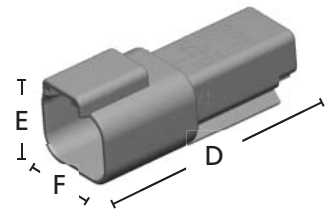
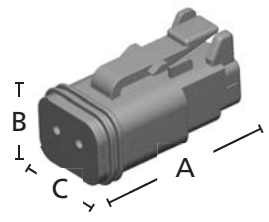

Cavity	DT Plug			DT Receptacle		
	Overall Length A	Overall Height B	Overall Width C	Overall Length D	Overall Height E	Overall Width F
2	1.118 (28.4)	.628 (15.95)	.591 (15.01)	1.708 (43.38)	.670 (17.02)	.675 (17.15)
3	1.118 (28.4)	.934 (23.72)	.718 (18.23)	1.698 (43.13)	.973 (24.71)	.832 (21.13)
4	1.218 (30.94)	.724 (18.39)	.716 (18.19)	1.808 (45.92)	.776 (19.71)	.820 (20.83)
6	1.218 (30.94)	.891 (22.63)	.716 (18.19)	1.808 (45.92)	.951 (24.16)	.820 (20.83)
8	1.217 (30.91)	.776 (19.71)	1.465 (37.21)	1.798 (45.67)	1.000 (25.40)	1.435 (36.45)
12	1.218 (30.94)	.716 (18.19)	1.597 (40.56)	1.808 (45.92)	.876 (22.25)	1.597 (40.56)

Dimensions are for reference only.

**DTM Series Dimensions**

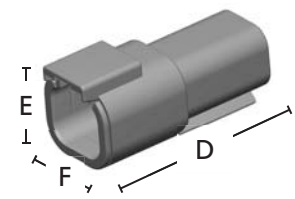
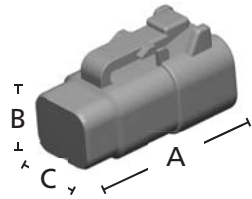

Cavity	DTM Plug			DTM Receptacle		
	Overall Length A	Overall Height B	Overall Width C	Overall Length D	Overall Height E	Overall Width F
2	1.620 (41.15)	.638 (16.21)	.475 (12.07)	1.085 (27.56)	.508 (12.90)	.651 (16.54)
3	1.620 (41.15)	.638 (16.21)	.640 (16.26)	1.085 (27.56)	.551 (14.00)	.861 (20.73)
4	1.720 (43.69)	.772 (19.61)	.600 (15.24)	1.185 (30.10)	.695 (17.65)	.756 (19.20)
6	1.720 (43.69)	.937 (23.80)	.600 (15.24)	1.185 (30.10)	.817 (20.75)	.756 (19.20)
8	1.720 (43.69)	.796 (20.22)	1.245 (31.62)	1.185 (30.10)	.600 (15.24)	1.245 (31.62)
12	1.720 (43.69)	.796 (20.22)	1.575 (40.01)	1.185 (30.10)	.600 (15.24)	1.575 (40.01)

Dimensions are for reference only.

**DTP Series Dimensions**

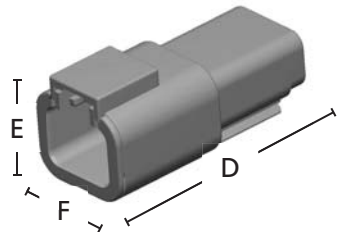
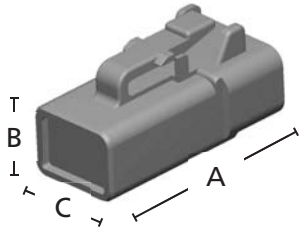

Cavity	DTP Plug			DTP Receptacle		
	Overall Length A	Overall Height B	Overall Width C	Overall Length D	Overall Height E	Overall Width F
2	1.364 (34.65)	.711 (18.06)	.732 (18.59)	1.861 (47.27)	.869 (22.07)	.732 (18.59)
4	1.364 (34.65)	.960 (24.38)	.868 (22.05)	1.861 (47.27)	1.069 (27.15)	.868 (22.05)

Dimensions are for reference only.

## DT Family Connector Configurations

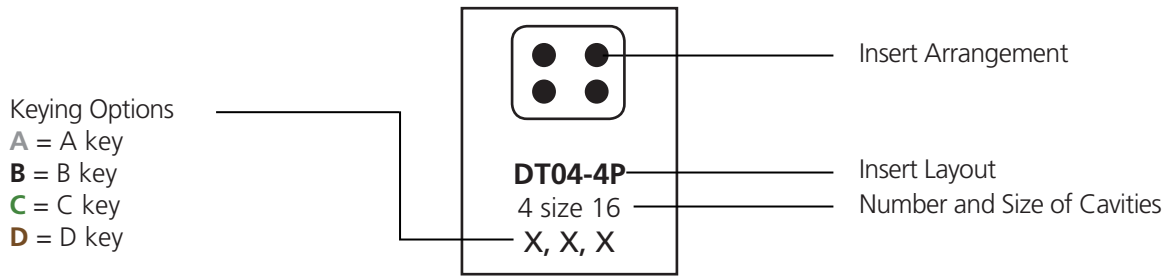

## DT Series Configurations

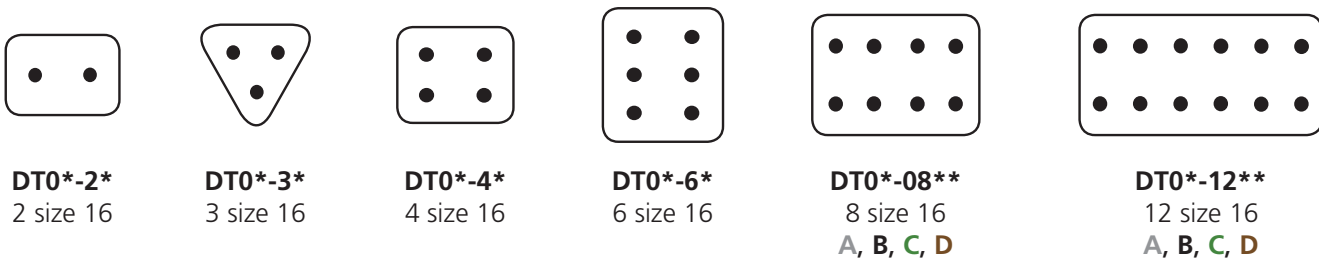

## DTM Series Configurations

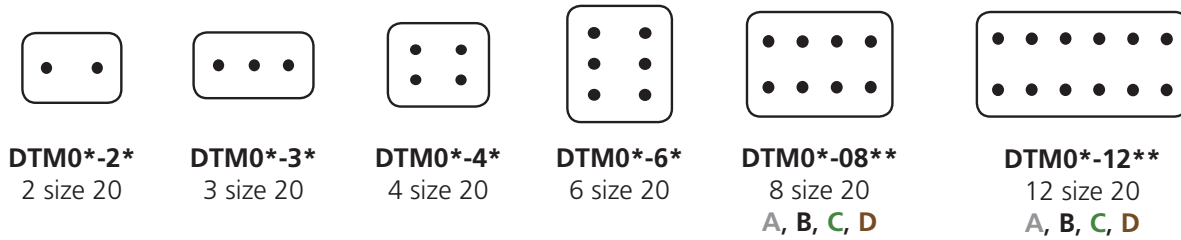

## DTP Series Configurations

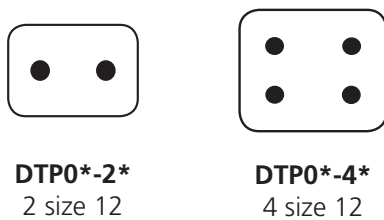







## Required Components





### ■ Secondary Wedgelocks

Deutsch DT style electrical connectors require secondary wedgelocks which are sold separately. The wedgelocks ensure proper contact alignment within each connector. Secondary wedgelocks are assembled at the mating interface and click into place. If by chance the secondary wedgelocks are not properly seated during assembly, they will be pressed into locked position during the mating of the connector.

Adding to the design flexibility of the DT Series, several wedgelocks offer keying options. Wedgelocks for enhanced seal retention plugs (P012) are also available.

#### DT Series Wedgelocks



Receptacle		
	W2P*	Wedgelock for 2 way receptacle *A, B, C, D keying available
	W3P*	Wedgelock for 3 way receptacle *J1939 keying available
	W4P*	Wedgelock for 4 way receptacle *A, B, C, D keying available
	W6P	Wedgelock for 6 way receptacle
	W8P	Wedgelock for 8 way receptacle
	W12P	Wedgelock for 12 way receptacle

Plug		
	W2S*	Wedgelock for 2 way plug *A, B, C, D keying available
	W3S*	Wedgelock for 3 way plug *J1939 keying available
	W4S*	Wedgelock for 4 way plug *A, B, C, D keying available
	W6S	Wedgelock for 6 way plug
	W8S	Wedgelock for 8 way plug
	W12S	Wedgelock for 12 way plug







**Notice**  
Wedgelocks for enhanced plugs (P012) are available.







#### DTP Series Wedgelocks

Receptacle		
	WP-2P	Wedgelock for 2 way receptacle
	WP-4P	Wedgelock for 4 way receptacle

Plug		
	WP-2S	Wedgelock for 2 way plug
	WP-4S	Wedgelock for 4 way plug

### DTM Series Wedgelocks

Receptacle		
	WM-2P*	Wedgelock for 2 way receptacle *A, B, C, D keying available
	WM-3P	Wedgelock for 3 way receptacle
	WM-4P	Wedgelock for 4 way receptacle
	WM-6P	Wedgelock for 6 way receptacle
	WM-8P	Wedgelock for 8 way receptacle
	WM-12P	Wedgelock for 12 way receptacle

Plug		
	WM-2S*	Wedgelock for 2 way plug *A, B, C, D keying available
	WM-3S	Wedgelock for 3 way plug
	WM-4S	Wedgelock for 4 way plug
	WM-6S	Wedgelock for 6 way plug
	WM-8S	Wedgelock for 8 way plug
	WM-12S	Wedgelock for 12 way plug

## Special Modifications

The DT Series connectors offer several modifications to enhance the design flexibility and meet application specific needs. Options include enhanced seal retention, flanges, and connector body color just to mention a few. By combining the DT Series connectors with the available modifications and accessories, the design possibilities are immense.

### ■ B016 Modification

The B016 receptacle modification provides safety against mis-mating. The B016 is available for the DT 12 way connectors, DT13/15, and DTF13/15 PCB Series connectors. In addition to the four keying positions (A, B, C, or D) and color coding, the B016 enhancement gives the user both visual and tactile proof of correct mating, thus eliminating mis-mating opportunities during assembly.

Please note the P012 plug is the required mate for the B016 receptacle to make the enhancement effective.



### ■ P012 Modification



The DT P012 plugs provide enhanced front seal retention providing an ultra tight environmental seal. The enhanced seal retention keeps the seal in place during mating and unmating. The P012 modification requires an enhanced P012 wedgelock. Deutsch's P012 modification is available in 2, 3, 4, 6, 8, and 12 cavity arrangements. P012 plugs have a black connector body except for the 8 and 12 cavity arrangements, where the color is based on the key.

### ■ E007 & E008 Modification

To meet the application requirements where wires need added protection, the DT (E008) and DTM (E007) Series may be supplied with shrink boot adapters. These adapters accept shrink tubing.



### ■ Flange Modifications

Designed to simplify wire routing and assembly, DT Series receptacles are available in many mounting configurations and styles.

#### Welded flange

- Welded flange - BL04, BL08, CL03, L012, LE14
- Welded flange, end cap - LE07, LE11
- Welded flange, shrink boot adapter - LE08, LE12

#### Sealed flange

- Sealed flange, end cap - CL09, LE01, LE05, LE06, LE09, LE10, LE17, LE21
- Sealed flange, shrink boot adapter - BL10, CL07



### ■ C015 Modification

The C015 modification offers a reduced diameter insert cavity allowing for a proper seal with smaller wire insulation. The C015 modification is also referred to as an "E" seal.



### ■ E003 Modification

The E003 modification offers a protective end cap attached to the rear of the connector. There are holes in the cap to allow the contacts to be inserted.



### ■ E004 Modification

The E004 modification changes the connector body color to black.



### ■ E005 Modification

The E005 modification offers a protective end cap attached to the rear of the connector and has a black connector body.



#### Notice

For additional modifications, please consult the factory.



## Accessories

Deutsch Industrial offers several accessory items that can be used to complement the connectors. The DT family accessories include items such as boots, backshells, gaskets, dust caps, and mounting clips. They are designed to assist in completing the design requirements of specific applications. Accessory items cover a wide array of design requirements such as assisting with mounting, providing additional protection, and offering increased aesthetics.

### Gaskets



Moisture, dirt, salt, sand, and road debris can all work their way into electrical panels through unsealed mounting flanges. Rated to operate in environments from -70°F to +225°F, these rugged high quality neoprene gaskets form a tight seal between the panel face and connector flange to help keep out destructive elements. The gaskets have a thickness of .125" and meet the UL-94-HBF, Mil-R-6130C, and FMVSS-302 flammability specifications.



Gasket P/N	Connector P/N
DT3P-L012-GKT	DT04-3P-L012
DT4P-L012-GKT	DT04-4P-L012
DTP4P-L012-GKT	DTP04-4P-L012
DT8P-L012-GKT	DT04-08P*-L012
DT12-L012-GKT	DT04-12P*-L012 DTM04-12P*-L012

### Dust Caps



The DT Series dust caps are made of either thermoplastic or durable plastisol and are designed to provide protection for the connector interface when the two halves are not mated. The plastisol caps, available for plugs and receptacles, are ideal for providing temporary protection from dirt, dust, and paint overspray. The thermoplastic caps provide an environmental seal for an unmated plug.



Thermoplastic Dust Cap P/N	Connector P/N
1011-344-0205	DT06-2S
1011-345-0305	DT06-3S
1011-346-0405	DT06-4S
1011-347-0605	DT06-6S
1011-348-0805	DT06-08S*
1011-349-1205	DT06-12S*



Plastisol Dust Cap P/N	Connector P/N
DTM3S-DC	DTM06-3S
DT3P-DC	DT04-3P
DT4P-DC	DT04-4P
DT6P-DC	DT04-6P
DTM12P-DC	DTM04-12P*
DT12P-DC, DT12P-DC-BK	DT04-12P*
DT12S-DC	DT06-12S*

**Boots**



Boots provide a professional looking finishing touch for your Deutsch DT family connectors. Made of durable plastisol, these slip-on boots are not only aesthetically appealing, but also provide increased protection from dirt, paint overspray, and pressure washing. The plastisol boots are rated from -20° F to +212° F and offer a slip-on design making installation quick and easy.



Receptacle Boot Description	Boot Part Number		
	DT Series	DTM Series	DTP Series
2 way receptacle boot, gray	DT2P-BT	DTM2P-BT	DTP2P-BT
2 way receptacle boot, black	DT2P-BT-BK	DTM2P-BT-BK	DTP2P-BT-BK
3 way receptacle boot, gray	DT3P-BT	DTM3P-BT	-
3 way receptacle boot, black	DT3P-BT-BK	-	-
4 way receptacle boot, gray	DT4P-BT	DTM4P-BT	DTP4P-BT
4 way receptacle boot, gray, enhanced length	-	-	DTP4P-BT-EN
6 way receptacle boot, gray	DT6P-BT	DTM6P-BT	-
6 way receptacle boot, black	DT6P-BT-BK	-	-
8 way receptacle boot, gray	DT8P-BT	DTM8P-BT	-
8 way receptacle boot, black	DT8P-BT-BK	-	-
12 way receptacle boot, gray	DT12P-BT	DTM12P-BT	-
12 way receptacle boot, black	DT12P-BT-BK	DTM12P-BT-BK	-
12 way receptacle boot, gray, enhanced length	DT12P-BT-EN	-	-



Plug Boot Description	Boot Part Number		
	DT Series	DTM Series	DTP Series
2 way plug boot, gray	DT2S-BT	DTM2S-BT	DTP2S-BT
2 way plug boot, black	DT2S-BT-BK	DTM2S-BT-BK	-
3 way plug boot, gray	DT3S-BT	DTM3S-BT	-
3 way plug boot, black	DT3S-BT-BK	DTM3S-BT-BK	-
4 way plug boot, gray	DT4S-BT	DTM4S-BT	DTP4S-BT
4 way plug boot, gray, enhanced length	-	-	DTP4S-BT-EN
6 way plug boot, gray	DT6S-BT	DTM6S-BT	-
6 way plug boot, black	DT6S-BT-BK	-	-
8 way plug boot, gray	DT8S-BT	DTM8S-BT	-
8 way plug boot, black	DT8S-BT-BK	DTM8S-BT-BK	-
12 way plug boot, gray	DT12S-BT	DTM12S-BT	-
12 way plug boot, black	DT12S-BT-BK	DTM12S-BT-BK	-
12 way plug boot, gray, enhanced length	DT12S-BT-EN	-	-
48 way plug boot, gray	DT48S-BT	-	-

## ■ Backshells



The Deutsch DT Series backshells are designed to snap onto and mate with all standard (basic plug and receptacles without modifications) DT Series connectors. The rigid, durable backshells offer a high level of protection and allow convoluted tubing to nest within the rear of the backshell. Straight (180°) and right angle (90°) versions and backshells with strain relief for jacketed cable are also available.

The backshells are available for both standard plugs and standard receptacles. Since they are designed to work with the standard DT connectors, tests should be conducted for fit and function of a backshell being used on any part with a modification.

### Receptacle Backshells

Connector	Style	Strain Relief	Tubing Size (mm)	P/N
DT04-2P	180°		6, 7.5, 8.5, and 10	1011-229-0205
	180°	X	6, 7.5, 8.5, and 10	1011-257-0205
	90°		6, 7.5, 8.5, and 10	1011-230-0205
	90°	X	6, 7.5, 8.5, and 10	1011-258-0205
DT04-3P	180°		6, 7.5, 8.5, and 10	1011-233-0305
	180°	X	6, 7.5, 8.5, and 10	1011-261-0305
	90°		6, 7.5, 8.5, and 10	1011-234-0305
	90°	X	6, 7.5, 8.5, and 10	1011-262-0305
DT04-4P	180°		6, 7.5, 8.5, and 10	1011-237-0405
	180°	X	6, 7.5, 8.5, and 10	1011-265-0405
	90°		6, 7.5, 8.5, and 10	1011-238-0405
	90°	X	6, 7.5, 8.5, and 10	1011-266-0405
DT04-6P	180°		8.5, 10, and 13	1011-241-0605
	180°	X	8.5, 10, and 13	1011-269-0605
	90°		8.5, 10, and 13	1011-242-0605
	90°	X	8.5, 10, and 13	1011-270-0605
DT04-08P*	180°		8.5, 10, and 13	1011-245-0805
	90°		8.5, 10, and 13	1011-246-0805
DT04-12P*	180°		10, 13, and 17	1011-249-1205
	90°		10, 13, and 17	1011-250-1205

### Plug Backshells

Connector	Style	Strain Relief	Tubing Size (mm)	P/N
DT06-2S	180°		6, 7.5, 8.5, and 10	1011-227-0205
	180°	X	6, 7.5, 8.5, and 10	1011-255-0205
	90°		6, 7.5, 8.5, and 10	1011-228-0205
	90°	X	6, 7.5, 8.5, and 10	1011-256-0205
DT06-3S	180°		6, 7.5, 8.5, and 10	1011-231-0305
	180°	X	6, 7.5, 8.5, and 10	1011-259-0305
	90°		6, 7.5, 8.5, and 10	1011-232-0305
	90°	X	6, 7.5, 8.5, and 10	1011-260-0305
DT06-4S	180°		6, 7.5, 8.5, and 10	1011-235-0405
	180°	X	6, 7.5, 8.5, and 10	1011-263-0405
	90°		6, 7.5, 8.5, and 10	1011-236-0405
	90°	X	6, 7.5, 8.5, and 10	1011-264-0405
DT06-6S	180°		8.5, 10, and 13	1011-239-0605
	180°	X	8.5, 10, and 13	1011-267-0605
	90°		8.5, 10, and 13	1011-240-0605
	90°	X	8.5, 10, and 13	1011-268-0605
DT06-08S*	180°		8.5, 10, and 13	1011-243-0805
	90°		8.5, 10, and 13	1011-244-0805
DT06-12S*	180°		10, 13, and 17	1011-247-1205
	90°		10, 13, and 17	1011-248-1205

## ■ Pull Off Strength



Connector	$F_P$ [N]	$F_T$ [N]
DT04-2P / DT06-2S	50 / 50	50 / 10
DT04-3P / DT06-3S	50 / 50	50 / 50
DT04-4P / DT06-4S	50 / 50	50 / 25
DT04-6P / DT06-6S	50 / 50	50 / 30
DT04-08P* / DT06-08S*	50 / 50	50 / 35
DT04-12P* / DT06-12S*	50 / 50	50 / 40

■ **Mounting Clips**

Mounting clips are used to mount DT Series connectors. To meet design needs, the clips are available for several configurations and in plastic or stainless steel.

Mounting Clip	Part Number	Used On (Receptacles)	Mounting Direction	Color/Material	Hole O.D. inches (mm)
	1027-003-1200	DT 2, 3, 4, 6, 12 DTM, DTP (all)	Straight	Stainless steel	.433 (11.0)
	1027-005-1200	DT 2, 3, 4, 6, 12 DTM, DTP (all)	Straight	Stainless steel	.512 (13.0)
	1027-004-1200	DT 2, 3, 4, 6, 12 DTM, DTP (all)	Straight	Steel w/ zinc plating	.512 (13.0)
	1027-008-1200	DT 2, 3, 4, 6, 12 DTM, DTP (all)	Side	Steel w/ zinc plating	.433 (11.0)
	1027-013-1200	DT 2, 3, 4, 6, 12 DTM, DTP (all)	Side	Steel w/ zinc plating	.323 (8.2)
	1027-001-0800	DT 8 cavity only	Straight	Stainless steel	.433 (11.0)
	1027-006-0800	DT 8 cavity only	Straight	Stainless steel	.512 (13.0)
	1027-002-0800	DT 8 cavity only	Straight	Steel w/ zinc plating	.512 (13.0)
	1027-014-0800	DT 8 cavity only	Straight	Steel w/ zinc plating	.323 (8.2)
	1011-026-0205	DT 2, 3, 4, 6, 12 DTM, DTP (all)	Straight	Gray plastic	.200 (5.08)
	1011-030-0205	DT 2, 3, 4, 6, 12 DTM, DTP (all)	Straight	Black plastic	---
	1011-310-0205* *Connector removeable with 50N of force	DT 2, 3, 4, 6, 12 DTM, DTP (all)	Straight	Black plastic	---
	1011-027-0805	DT 8 cavity only	Straight	Gray plastic	.200 (5.08)

## DTV Series Overview

Deutsch's DTV Series connectors offer the same time tested reliability and performance as the DT Series, with the added flexibility of an 18 cavity flanged design. Deutsch continues its tradition of providing an environmentally sealed connector to meet even your toughest application needs.



### DTV Series Part Numbering System

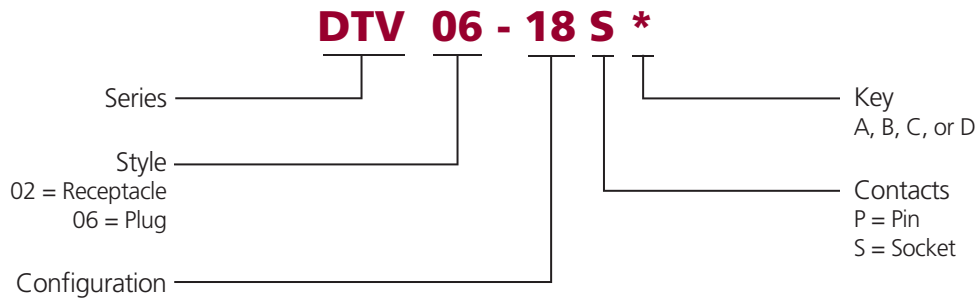

### DTV Series Dimensions

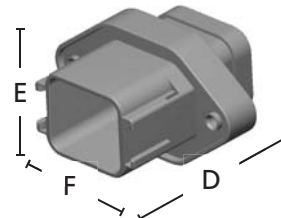
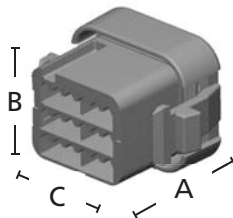



Cavity	DTV Plug			DTV Receptacle		
	Overall Length A	Overall Height B	Overall Width C	Overall Length D	Overall Height E	Overall Width F
18	1.405 (35.69)	1.059 (26.90)	1.450 (36.83)	2.495 (63.37)	1.786 (45.36)	3.194 (81.12)

Dimensions are for reference only.

### Secondary Wedgelocks

#### DTV Series Wedgelocks

Receptacle		
	WV-18P	Wedgelock for 18 way receptacle

Plug		
	WV-18S	Wedgelock for 18 way plug

## DTMH Series Overview

The DTMH is an environmentally sealed, high temperature connector capable of operating in temperatures -55° to +150°C. The DTMH accepts size 20 contacts and carries 7.5 amps each. The DTMH connectors feature an integrated TPA for easy assembly.



### DTMH Series Part Numbering System

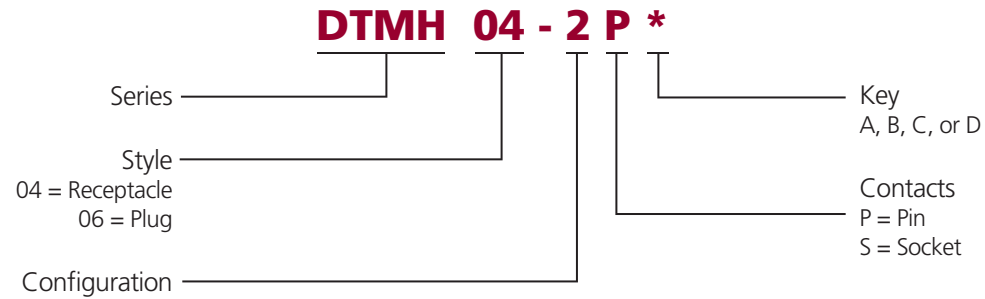

### DTMH Series Configurations



**DTMH0\*-2\*\*** 2 size 20    **DTMH0\*-3\*\*** 3 size 20    **DTMH0\*-4\*\*** 4 size 20

### DTMH Series Dimensions

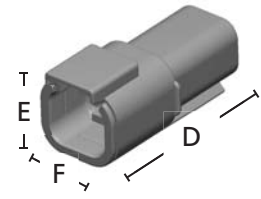
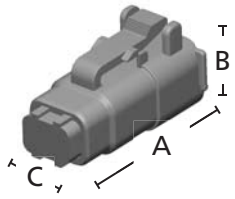

Cavity	DTMH Plug			DTMH Receptacle		
	Overall Length A	Overall Height B	Overall Width C	Overall Length D	Overall Height E	Overall Width F
2	1.085 (27.56)	.508 (12.90)	.555 (14.10)	1.620 (41.15)	.638 (16.21)	.729 (18.52)
3	1.085 (27.56)	.558 (14.17)	.640 (16.26)	1.620 (41.16)	.638 (16.21)	.894 (22.71)
4	1.185 (30.10)	.652 (16.56)	.680 (17.27)	1.720 (43.69)	.772 (19.61)	.834 (21.18)

Dimensions are for reference only.

## DTMN Series Overview

The DTMN is a non-environmentally sealed connector. The DTMN is available in a 2 or 3 cavity connector and accepts size 20 contacts. The DTMN connector is designed to offer Deutsch quality and reliability when a sealed connector is not required.



### DTMN Series Part Numbering System

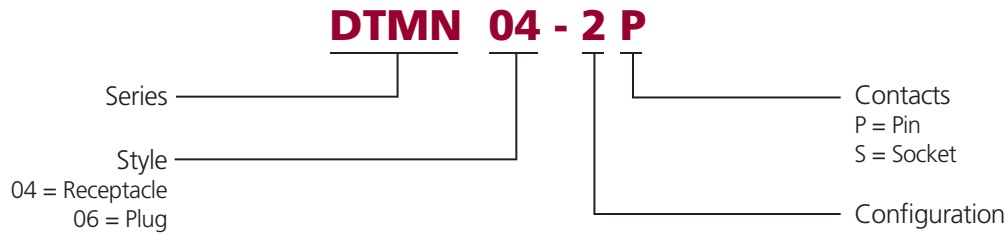

### DTMN Series Configurations



**DTMN0\*-2\*\***    **DTMN0\*-3\*\***  
2 size 20        3 size 20

### DTMN Series Dimensions

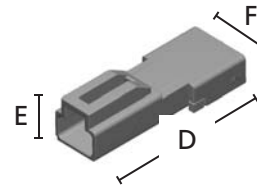
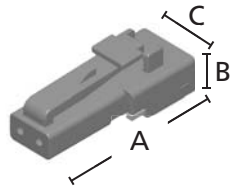

Cavity	DTMN Plug			DTMN Receptacle		
	Overall Length A	Overall Height B	Overall Width C	Overall Length D	Overall Height E	Overall Width F
2	.950 (24.13)	.346 (8.78)	.370 (9.40)	1.198 (30.43)	.334 (8.48)	.444 (11.28)
3	.945 (24.00)	.406 (10.31)	.785 (19.93)	1.188 (30.18)	.400 (10.16)	.810 (20.56)

Dimensions are for reference only.



## How To Instructions

### ■ Contact Insertion



**Step 1:**  
Grasp crimped contact approximately one inch behind the contact barrel.



**Step 2:**  
Hold connector with rear grommet facing you.



**Step 3:**  
Push contact straight into connector grommet until a click is felt. A slight tug will confirm that it is properly locked in place.



**Step 4:**  
Once all contacts are in place, insert green wedge. The green wedge will snap into place.

### ■ Contact Removal



**Step 1:**  
Remove green wedge using needlenose pliers to pull wedge straight out.



**Step 2:**  
To remove the contacts, gently pull wire backwards, while at the same time releasing the locking finger by moving it away from the contact with a screwdriver.



**Step 3:**  
Hold the rear seal in place, as removing the contact will displace the seal.

*Notice*  
The receptacle is shown, use the same procedure for the plug.





# Diodes & Resistors

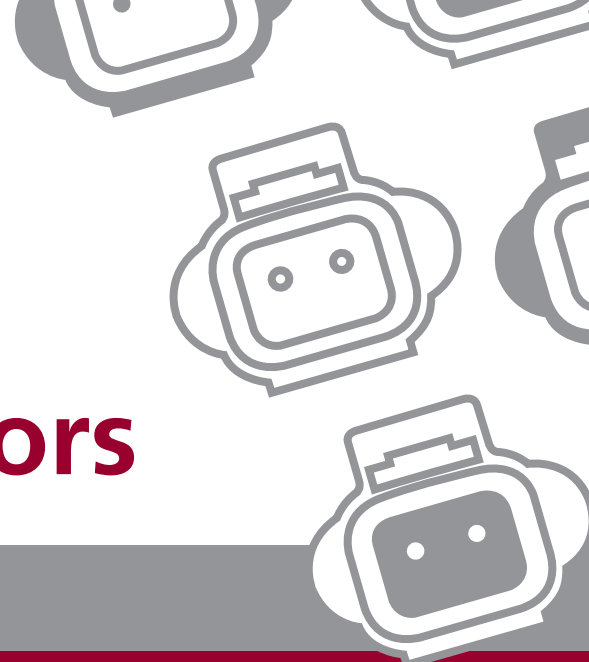

## Contents

Diodes & Resistors Overview	34
Part Numbering System	34
Configurations	34
Diode & Resistor Characteristics	35

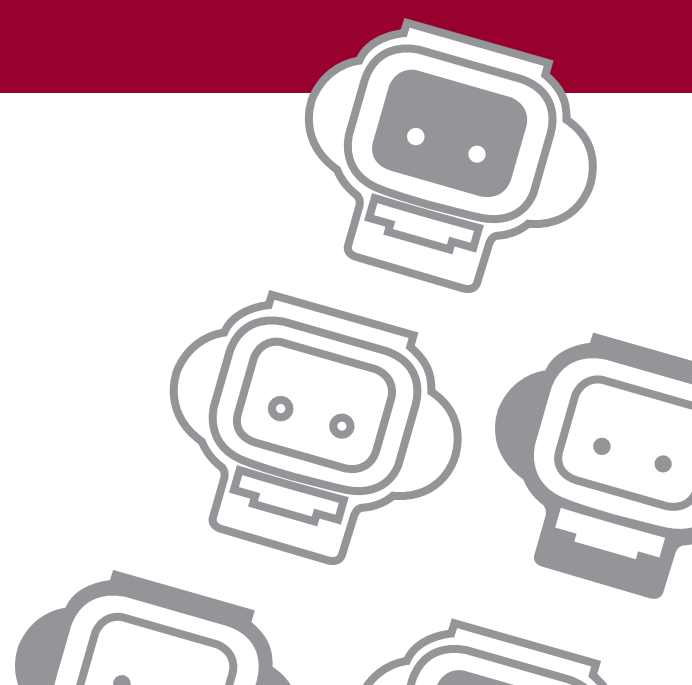



## Diodes & Resistors Overview

Deutsch DT connectors with diodes and resistors are useful anywhere you need to regulate power or protect a device against a potential power surge.

A diode allows current to flow in one direction only. By preventing current from traveling a circuit in the wrong direction, a diode can protect an electronic device from damage. Devices with batteries will often use diodes to prevent power from flowing in reverse if the battery is not installed correctly.

A resistor limits or blocks current flow in both directions. Resistors protect sensitive electronics by limiting the amount of electricity that can flow to the device through the resistor, and therefore preventing power spikes. For example, resistors are used to prevent power surges from burning out an LED by restricting current flow to the light.

Deutsch diode and resistor connectors are easily added to an application after the fact if unwanted power surges are discovered.

### Part Numbering System

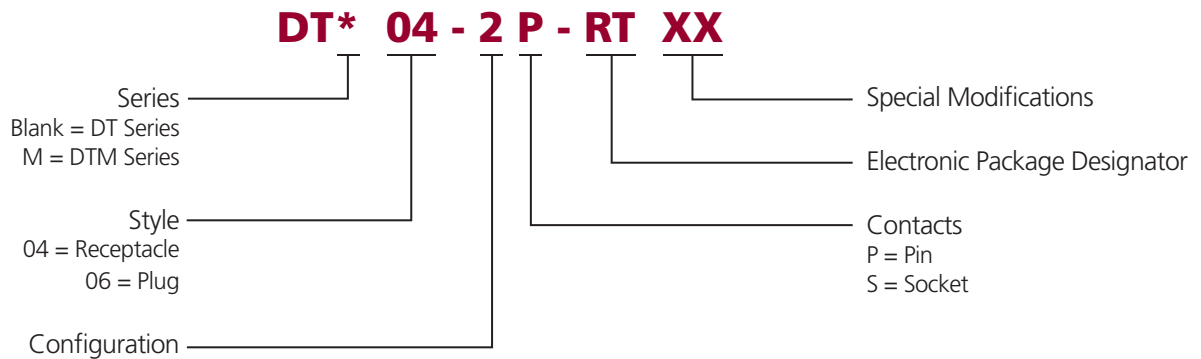

### Diode & Resistor Configurations

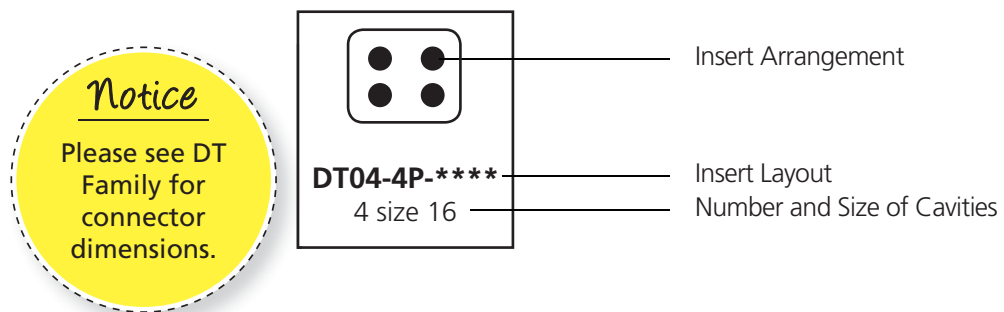

### DTM Series Configurations



**DTM0\*-2\*-\*\*\*\***  
2 size 20

### DT Series Configurations



**DT0\*-2\*-\*\*\*\***  
2 size 16





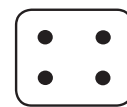

**DT0\*-3\*-\*\*\*\***  
3 size 16











**DT0\*-4\*-\*\*\*\***  
4 size 16

**Deutsch Diode Characteristics**

DT Series	Part Number	Plug or Receptacle	Diode Part Number	Peak Reverse Volts	Peak Forward Volts	Avg. Forward Current	Color
	DT04-2P-RT01	Receptacle	Motorola Diode: MUR460	600 V max.	1.28 V max.	4.0 A max.	Black
	DT04-2P-RT02	Receptacle	Toshiba Diode: 3GZXX	400 V max.	1.0 V max.	3.0 A max.	Black
	DT04-4P-RT01	Receptacle	Motorola Diode: MUR460 (3)	600 V max.	1.28 V max.	4.0 A max.	Black
	DT04-4P-RT03	Receptacle	Motorola Diode: MUR460 (2)	600 V max.	1.28 V max.	4.0 A max.	Gray

**Deutsch Resistor Characteristics**

DTM Series	Part Number	Plug or Receptacle	Resistor Ohms	Resistor Watts	Resistor Tolerance	Color
	DTM04-2P-EP10	Receptacle	120	0.4	5%	Black (B keyed wedgelock included)
	DTM04-2P-P006	Receptacle	120	0.4	5%	Gray (A keyed wedgelock included)
	DTM06-2S-EP10	Plug	120	0.4	5%	Black (B keyed wedgelock included)
	DTM06-2S-P006	Plug	120	0.4	5%	Gray (A keyed wedgelock included)
DT Series	Part Number	Plug or Receptacle	Resistor Ohms	Resistor Watts	Resistor Tolerance	Color
	DT04-2P-RT25	Receptacle	27k	0.5	1%	Black
	DT04-3P-EP10	Receptacle	120	0.4 min.	10%	Black (J1939 keyed wedgelock included)
	DT04-3P-P006	Receptacle	120	0.4 min.	10%	Gray (J1939 keyed wedgelock included)
	DT06-3S-EP10	Plug	120	0.4 min.	10%	Black (J1939 keyed wedgelock included)
	DT06-3S-P006	Plug	120	0.4 min.	10%	Gray (J1939 keyed wedgelock included)







# Bussing Options

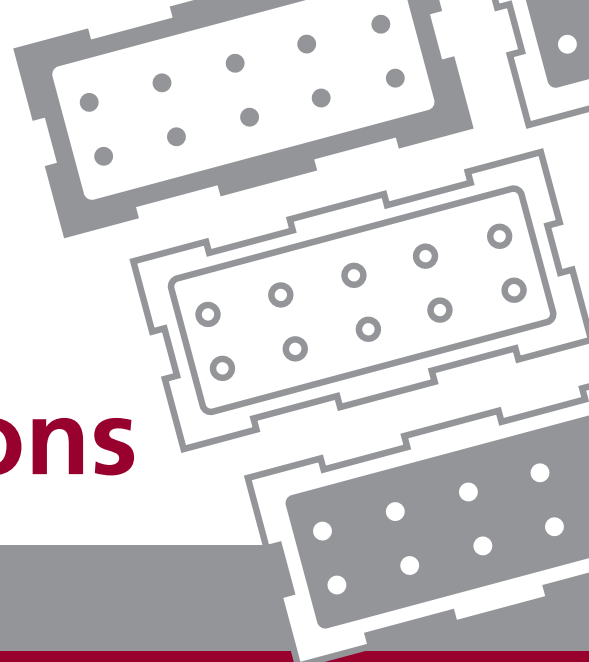

## Contents

DT Bussed Feedback Overview 38

---

DT Family Part Numbering System 38

---

DT Series Dimensions 38

---

DT Bussed Arrangements 39

---

HDFB Series Overview 40

---

HDFB Part Numbering System 40

---

HDFB Series Dimensions 40

---

HDFB Series Arrangements 41

---

HDFB Series Accessories 41

---

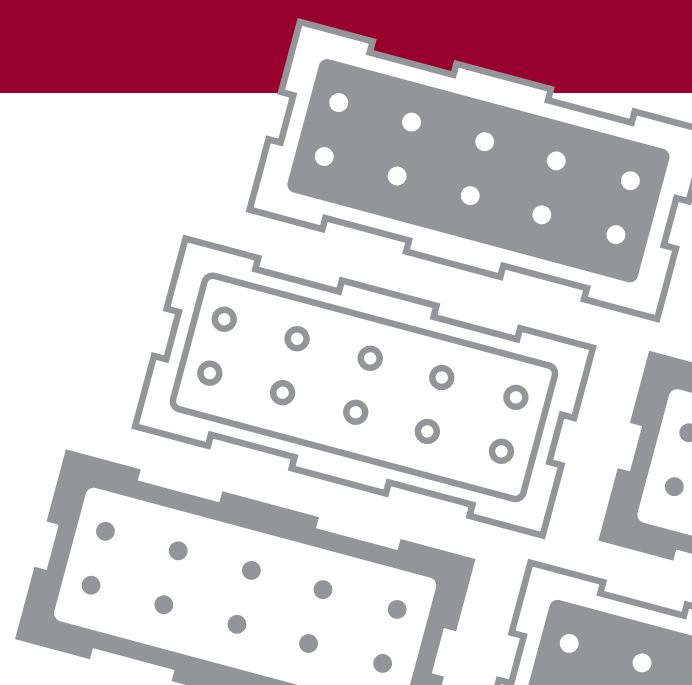





## Bussed Overview

Deusch Industrial bussed feedback receptacles are environmentally sealed connectors designed for use in heavy duty applications where multiple circuits require a common electrical pathway. Available in the DT and HDFB Series, Deusch bussed connectors feature integrated bussbars with standard Deusch contacts.

A bussbar, or buss, is a thin conductive strip connecting two or more contacts within the body of a connector. Bussbars allow power or data to be fed into a connector through one or more terminals and drawn out as needed through the other contacts on the same buss. Connectors can carry one or more bussbars, creating multiple independent electrical circuits within the same connector body and distributing power or data to many components. A single bussed connector can replace several standard connectors or splices, saving space, wiring, and weight.

### DT Series Bussed Feedback Receptacles

DT bussed feedback receptacles are a compact economical bussing option housed in rugged, field-proven DT receptacle bodies. The bussed DTs mate with standard DT plugs and meet all the performance specifications for the DT Series. The connectors are available in multiple buss configurations using standard size 16 contacts, with plating options in nickel or gold.



### DT Family Part Numbering System

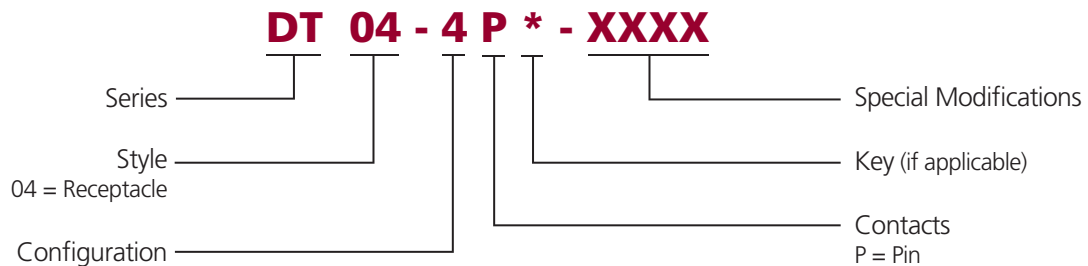



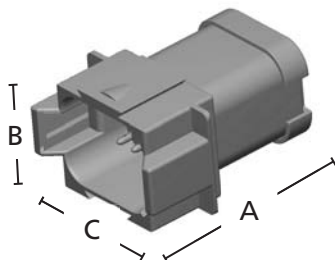



### DT Series Dimensions



Cavity	DT Receptacle		
	Overall Length A	Overall Height B	Overall Width C
4	1.868 (47.45)	.797 (20.24)	.820 (20.83)
6	1.858 (47.19)	.972 (24.69)	.820 (20.83)
8	1.848 (46.94)	1.000 (25.40)	1.435 (36.45)
12	2.043 (51.89)	.876 (22.25)	1.597 (40.56)

Dimensions are for reference only.

**DT Series Bussed Arrangements**

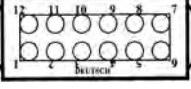
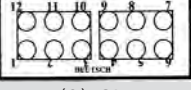
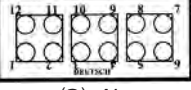
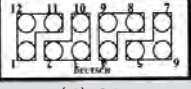
Bussing Arrangements	Maximum Current Rating*	Buss Plating	Connector Color	Receptacle Part Number	Mating Plug Part Number
 (1) 4	(1) 4 Pin Buss=26 amps	Nickel Nickel	Black Gray	DT04-4P-EP13 DT04-4P-P021	DT06-4S-**** DT06-4S-****
 (1) 6	(1) 6 Pin Buss=39 amps	Nickel Nickel	Black Gray	DT04-6P-EP13 DT04-6P-P021	DT06-6S-**** DT06-6S-****
 (2) 3's	(2) 3 Pin Busses=13 amps each	Nickel	Black	DT04-6P-EP14	DT06-6S-****
 (1) 8	(1) 8 Pin Buss=52 amps	Nickel Nickel	Gray Black	DT04-08PA-P021 DT04-08PB-P021	DT06-08SA-**** DT06-08SB-****
 (1) 3, (1) 5	(1) 3 Pin Buss=13 amps (1) 5 Pin Buss=26 amps	Nickel Nickel	Gray Black	DT04-08PA-P028 DT04-08PB-P028	DT06-08SA-**** DT06-08SB-****
 (2) 4's	(2) 4 Pin Busses=26 amps each	Nickel Nickel	Gray Black	DT04-08PA-P026 DT04-08PB-P026	DT06-08SA-**** DT06-08SB-****
 (1) 12	(1) 12 Pin Buss=78 amps	Gold Gold Nickel Nickel	Gray Black Gray Black	DT04-12PA-P016 DT04-12PB-P016 DT04-12PA-P021 DT04-12PB-P021	DT06-12SA-**** DT06-12SB-**** DT06-12SA-**** DT06-12SB-****
 (2) 6's	(2) 6 Pin Busses=39 amps each	Nickel Nickel Gold	Gray Black Black	DT04-12PA-P026 DT04-12PB-P026 DT04-12PB-P027	DT06-12SA-**** DT06-12SB-**** DT06-12SB-****
 (3) 4's	(3) 4 Pin Busses=26 amps each	Nickel	Gray	DT04-12PA-P075	DT06-12SA-****
 (4) 3's	(4) 3 Pin Busses=13 amps each	Nickel Nickel Gold Gold	Gray Black Gray Black	DT04-12PA-P030 DT04-12PB-P030 DT04-12PA-P031 DT04-12PB-P031	DT06-12SA-**** DT06-12SB-**** DT06-12SA-**** DT06-12SB-****

\*Maximum current rating is the total amperage for the buss

**Notice**

The maximum current rating is the total amount of current for the entire buss. Current can be distributed in many combinations, but cannot exceed 13 amps per contact.

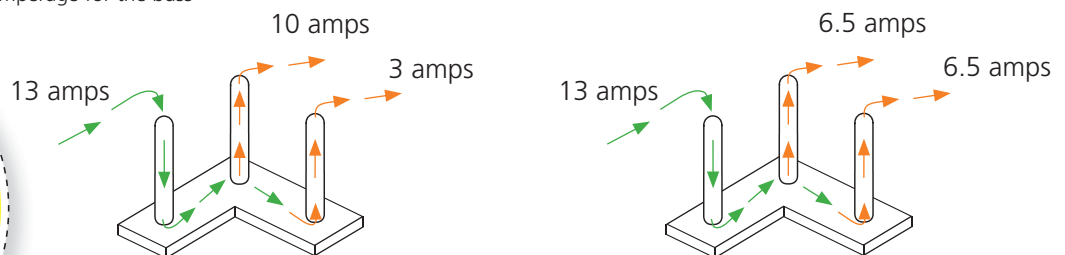

In the examples, there are three size 16 pins each rated for 13 amps mounted to the buss. A total of 13 amps can be pulled into one pin and going out the 13 amps are split between the remaining two pins. No more than 13 amps can go through any single pin.



## HDFB Series Overview



Deutsch Industrial HDFB connectors are self-contained, environmentally sealed, bussed feedback modules designed for use in heavy duty applications. Available in five bussing arrangements with two contact sizes, each HDFB holds one or more integrated busses formed from standard Deutsch pin contacts and a thin conductive strip. HDFBs mount in place with lightweight aluminum brackets, and the pins inside mate with standard Deutsch sockets.



## HDFB Series Part Numbering System

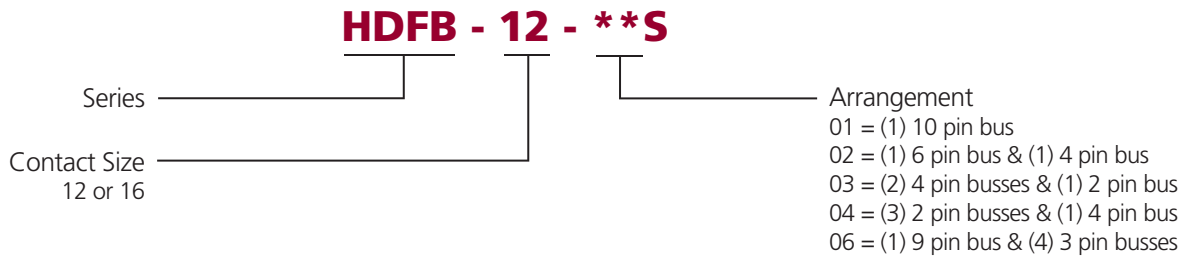

## HDFB Series Dimensions

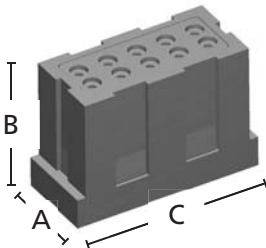

Bussing Arrangement	HDFB Receptacle		
	Overall Length A	Overall Height B	Overall Width C
01-04	1.197 (30.40)	1.589 (40.36)	2.310 (58.67)
06	1.197 (30.40)	1.619 (41.12)	2.326 (59.08)

Dimensions are for reference only.

**HDFB Series Arrangements**

**Size 12 Contacts**

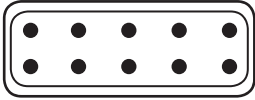

**HDFB-12-01S**  
01 Arrangement

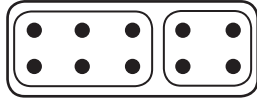

**HDFB-12-02S**  
02 Arrangement

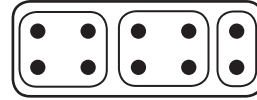

**HDFB-12-03S**  
03 Arrangement

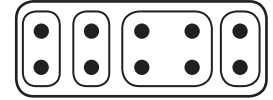

**HDFB-12-04S**  
04 Arrangement

**Size 16 Contacts**

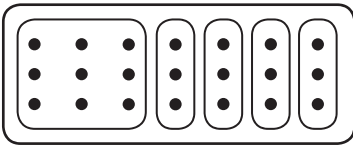

**HDFB-16-06S**  
06 Arrangement

**Accessories**

Deutsch Industrial offers mounting brackets for use with the HDFB Series. The brackets are aluminum and accommodate two or three HDFB modules. Please request a drawing for mounting specifications.

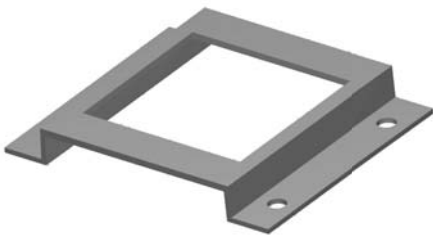

**Mounting Brackets**

Part Number	Description
0427-202-0290	2 module capacity mounting bracket, outside dimensions 3.575 x 3.019 (90.81 x 76.68)
0427-201-0390	3 module capacity mounting bracket, outside dimensions 3.575 x 4.016 (90.81 x 102.01)





# Controller Area Networks

## Contents

CAN Overview 44

---

J1939/13 9-pin Diagnostic 45

---

J1939/11 Schematics 46

---

J1939/15 Schematics 47

---

ISO Box 48

---



## CAN Overview

Controller Area Networks, or CAN are multiplex data systems. Multiplexing allows multiple data signals to travel on the same wires, integrating separate electronic systems and applications to a single point control and monitoring system. Using signals sent over a serial network, CAN systems provide instantaneous monitoring of diagnostic and control systems allowing early detection of potential problems. Early detection of problems leads to lower repair costs and reduced downtime. CAN systems allow an operator to use a single command station to control diagnostic systems and receive such varied information as brake and transmission temperature, tire pressure, fuel efficiency, and emissions levels. Anything that can be measured and controlled electronically can be monitored and directed by a CAN system.

Whether you're building a Controller Area Network for anything from on/off-highway, construction, material handling, agriculture machines, or your OEM fleet of fire engines, Deutsch has a solution for your CAN needs. Deutsch offers several configurations: 2-wire, 3-wire, and 4-wire, with in-line and flange mount, along with splitters, heavy duty breakaway connectors, and an off-board 9-pin diagnostic connector.

SAE J1939 is a specific type of CAN that defines the communications pathways for vehicle networks. Improved electrical systems as defined under SAE J1939 allow electrical devices to communicate with each other. Communication occurs using a Controlled Area Network between intelligent sensors over a serial network. Through a series of microprocessors a CAN interconnects every device establishing a common link between each.

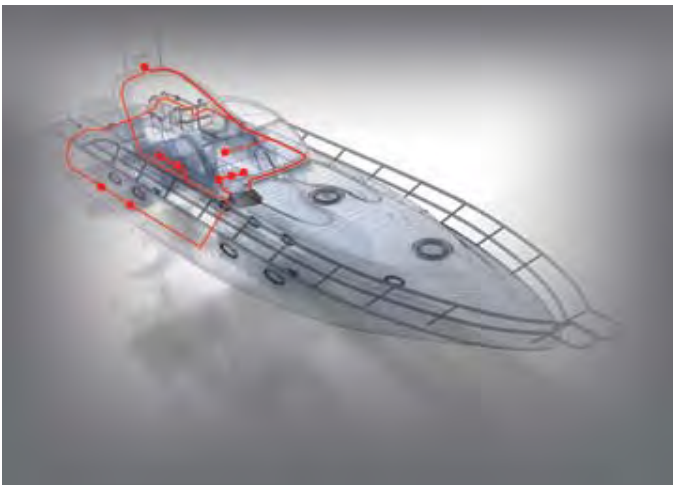

There are four main electrical interconnect subsets of J1939 including /11, /12, /13, and /15:

- J1939/11 is a 3-wire system that uses the Deutsch DT Series connectors primarily for truck and bus. The DT Series accepts size 16 contacts and 14-20 AWG. Connector options include in-line, bulkhead, "Y" splitter, and terminating resistors.
- J1939/12 is a system that requires the Deutsch DT Series, HD30 Series, and ISO Box (HDBox). This group of electrical interfaces terminates a CAN between the tractor and its implement. Its main feature is a breakaway function that prevents damage to the tractor or implement in case of an accidental drive-away disconnect.
- J1939/13 is a system that uses the Deutsch HD10 Series connectors for on-board diagnostics. The HD10 Series accepts size 16 contacts and 14-20 AWG.
- J1939/15 is a 2-wire system that uses the Deutsch DTM Series connectors. The DTM Series accepts size 20 contacts and 16-22 AWG. Connector options include in-line, "Y" splitter, and terminating resistors.

The continued sophistication in design of equipment is demanding increased response of electrical systems. The application of J1939 has allowed designers to improve both the quantity and the quality of the options offered along with the increased electrical system reliability.



## ■ J1939/13 Universal 9-pin Diagnostic

Description	Part Number
Receptacle	HD10-9-1939P
Receptacle, Panel Nut Mount	HD10-9-1939P-B022
Receptacle, Panel Nut Mount, Reduced Wire Seal	HD10-9-1939PE-B022
Receptacle, Reduced Wire Seal	HD10-9-1939PE
Plug, Coupling Ring	HD16-9-1939S
Plug, Coupling Ring, Reduced Wire Seal	HD16-9-1939SE
Plug, No Coupling Ring (Slip-on)	HD17-9-1939S
Plug, No Coupling Ring (Slip-on), Reduced Wire Seal	HD17-9-1939SE
Pin, Solid, Size 16, Gold	0460-202-1631
Pin, Solid, Size 16, Gold, Extended	0460-247-1631
Socket, Solid, Size 16, Gold	0462-201-1631
Socket, Solid, Size 16, Gold, Extended	0462-221-1631

Deutsch's J1939/13, HD10 9 pin connector is a standard diagnostic tool interface for on- and off-highway OEMs. The HD10-9-1939P is a data port connector designed to allow an on-board CAN system to mate with a diagnostic computer. The connectors are for use with the 250 kbps network. The Deutsch HD10 J1939/13 connectors offer several mounting options for the receptacle, and a mating plug that is available with or without a coupling ring.



## ■ J1939/13 Type II Universal 9-pin Diagnostic

Description	Part Number
Receptacle, Flange Mount, Type II	HD10-9-1939P-P080
Receptacle, Flange Mount, Type II, Reduced Wire Seal	HD10-9-1939PE-P080
Receptacle, Panel Nut Mount, Type II	HD10-9-1939P-BP03
Receptacle, Panel Nut Mount, Type II, Reduced Wire Seal	HD10-9-1939PE-BP03
Receptacle, Type II	HD14-9-1939P-P080
Receptacle, Type II, Reduced Wire Seal	HD14-9-1939PE-P080
Plug, Coupling Ring, Type II	HD16-9-1939S-P080
Plug, Coupling Ring, Type II, Reduced Wire Seal	HD16-9-1939SE-P080
Plug, No Coupling Ring (Slip-on), Type II	HD17-9-1939S-P080
Plug, No Coupling Ring (Slip-on), Type II, Reduced Wire Seal	HD17-9-1939SE-P080
Pin, Solid, Size 16, Gold	0460-202-1631
Pin, Solid, Size 16, Gold, Extended	0460-247-1631
Socket, Solid, Size 16, Gold	0462-201-1631
Socket, Solid, Size 16, Gold, Extended	0462-221-1631

Deutsch's J1939/13, HD10 9 pin connector is a standard diagnostic tool interface for on- and off-highway OEMs. The HD10-9-1939P\*-P080 is a data port connector designed to allow an on-board CAN system to mate with a diagnostic computer. The green, Type II connectors, HD10-9-1939P-P080, are for use with the 500 kbps network. The Deutsch HD10 J1939/13 connectors offer several mounting options for the receptacle, and a mating plug that is available with or without a coupling ring.





## SAE J1939/11 Deutsch Connector Options

Deutsch J1939/11 connectors are rugged field proven DT 3 pin connectors designed to meet the SAE requirements for 3-wire CAN applications linking ECUs for serial data communications. The DT 3 way connectors accommodate the CAN\_HI, CAN\_LO and shield wires with a variety of options including “Y” receptacles, connectors with mounting flanges, keyed wedgelocks to prevent mis-mating, and network terminating connectors with molded-in 120Ω resistors.

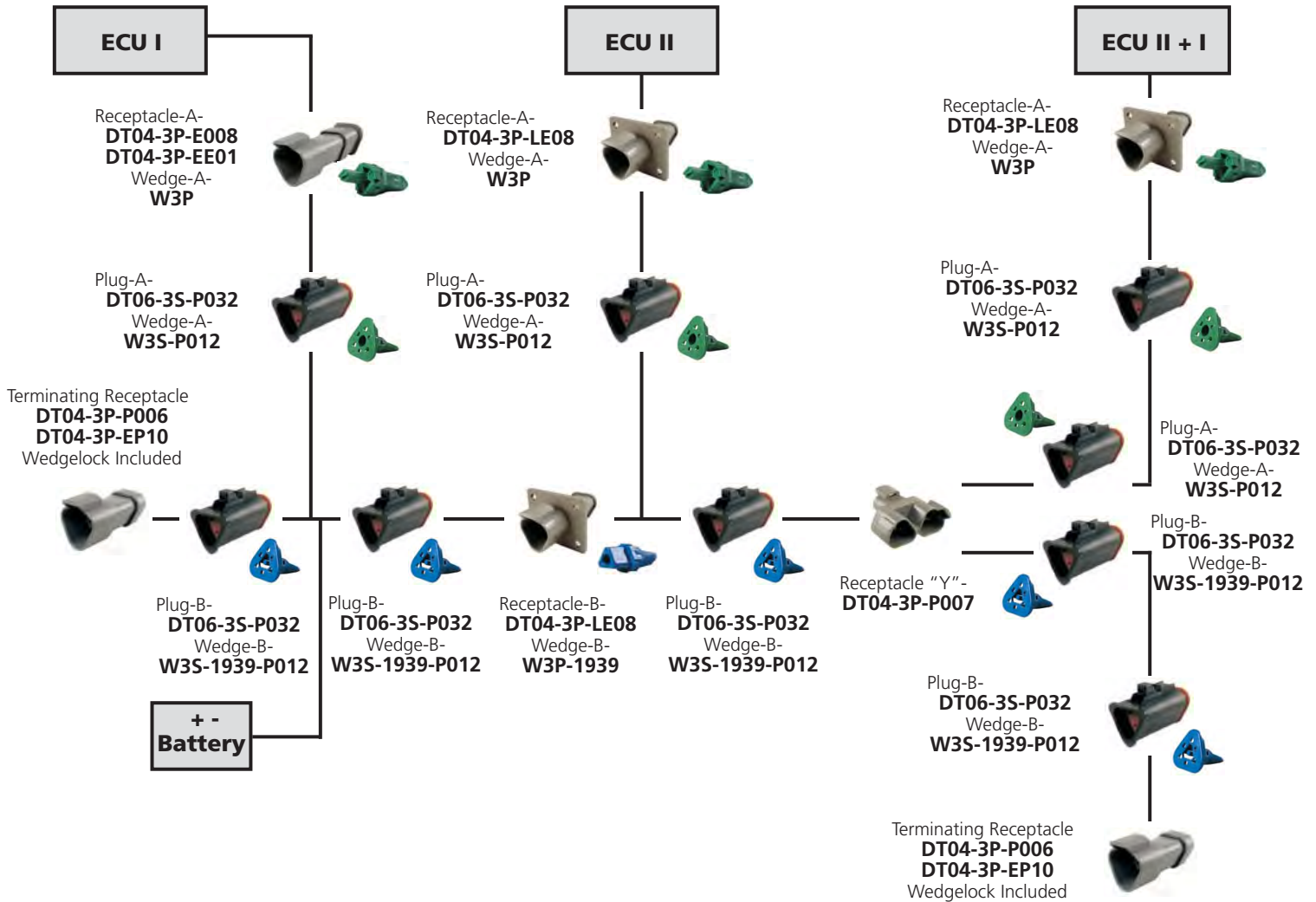

### J1939/11 3 Wire System

Part Number	Description	Part Number	Description
DT04-3P-P007	Receptacle, "Y" Connector	W3P-1939	Wedgelock, Blue
DT04-3P-E008	Receptacle, Gray, Shrink Boot Adapter	W3S	Wedgelock, Orange
DT04-3P-P006	Receptacle, Gray, 120 Ohm Resistor	W3S-P012	Wedgelock, Green
DT04-3P-EE01	Receptacle, Black, Shrink Boot Adapter	W3S-1939	Wedgelock, Blue
DT04-3P-EP10	Receptacle, Black, 120 Ohm Resistor	W3S-1939-P012	Wedgelock, Blue
DT06-3S-E008	Plug, Gray, Shrink Boot Adapter	0460-202-1631	Pin, Solid, Size 16, Gold
DT06-3S-P006	Plug, Gray, 120 Ohm Resistor	1060-16-0144	Pin, Stamped & Formed, Size 16, Gold
DT06-3S-EP11	Plug, Black, Shrink Boot Adapter	0460-247-1631	Pin, Solid, Size 16, Gold, Extended
DT06-3S-PP01	Plug, Black, 120 Ohm Resistor	0462-201-1631	Socket, Solid, Size 16, Gold
DT06-3S-PE01	Plug, Black, 120 Ohm Resistor, Latch Guard	1062-16-0144	Socket, Stamped & Formed, Size 16, Gold
DT06-3S-P032	Plug, Black, Single Piece Shrink Boot Adapter	0462-221-1631	Socket, Solid, Size 16, Gold, Extended

## SAE J1939/15 Deutsch Connector Options

SAE J1939/15 defines the requirements for reduced physical layer 2-wire CAN systems consisting of an unshielded twisted pair of wires. Deutsch DTM 2 way connectors are offered in several modifications to meet the requirements of this standard. DTM connectors for serial data communications include “Y” receptacles, connectors with end caps and shrink boot adapters, and receptacles with molded-in 120Ω resistors for network terminations.

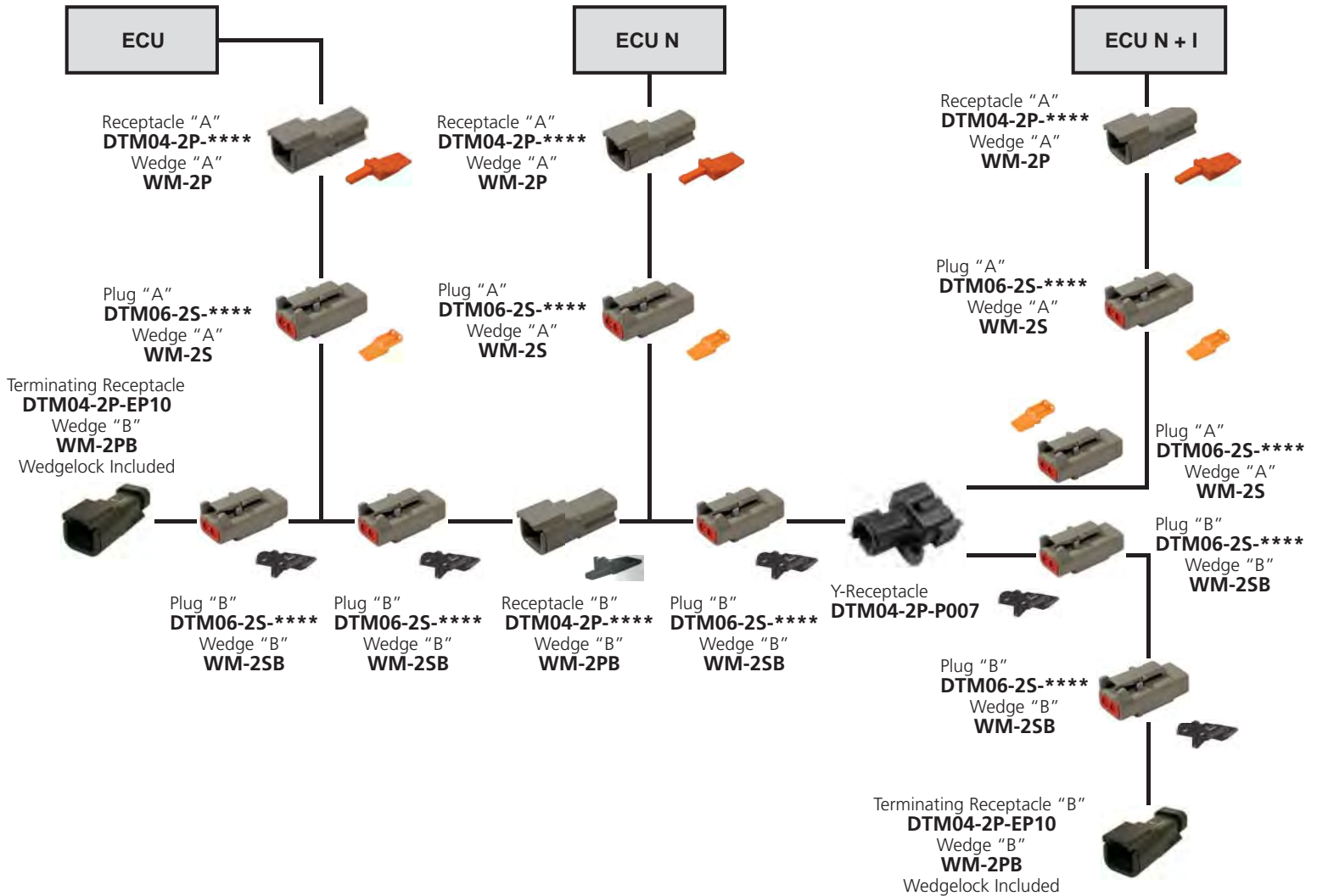

### J1939/15 2 Wire System

Part Number	Description	Part Number	Description
DTM04-2P-P007	Receptacle, "Y" Connector	WM-2PA	Wedglock, Gray
DTM04-2P-E007	Receptacle, Gray, Shrink Boot Adapter	WM-2PB	Wedglock, Black
DTM04-2P-P006	Receptacle, Gray, 120 Ohm Resistor	WM-2S	Wedglock, Orange
DTM04-2P-EE03	Receptacle, Black, Shrink Boot Adapter	WM-2SA	Wedglock, Gray
DTM06-2S-P007	Plug, Gray, Shrink Boot Adapter	WM-2SB	Wedglock, Black
DTM06-2S-P006	Plug, Gray, 120 Ohm Resistor	0460-202-2031	Pin, Solid, Size 20, Gold
DTM06-2S-EE03	Plug, Black, Shrink Boot Adapter	1060-20-0144	Pin, Stamped & Formed, Size 20, Gold
DTM06-2S-EP10	Plug, Black, 120 Ohm Resistor	0462-201-2031	Socket, Solid, Size 20, Gold
WM-2P	Wedglock, Orange	1062-20-0144	Socket, Stamped & Formed, Size 20, Gold



## ISO/CD 11783-2 & J1939/12 ISO Box and Associated Connectors

Description	Part Number
ISO Box Assembly	HDBOX-24-91PN
ISO Box Assembly, Reduced Wire Seal	HDBOX-24-91PE
Plug, Cable Clamp Assembly	HD36-24-91SN-059
Plug, Cable Clamp Assembly, Reduced Wire Seal	HD36-24-91SE-059
Plug, Breakaway Coupling, Cable Clamp Assembly	HDB36-24-91SN-059
Plug, Breakaway Coupling, Cable Clamp Assembly, Reduced Wire Seal	HDB36-24-91SE-059
Plug, Black, End Cap	DT06-4S-EP06*
Plug, Black, End Cap	DT06-2S-EP06*
Wedgelock, Green	W4S-P012
Wedgelock, Green	W2S-P012
Pin, Solid, Size 8	0460-204-08141
Pin, Solid, Size 12	0460-204-12141
Pin, Solid, Size 16, Gold	0460-202-1631
Socket, Solid, Size 8	0462-203-08141
Socket, Solid, Size 12	0462-203-12141
Socket, Solid, Size 16, Gold	0462-201-1631

\*DT Series receptacles are molded in the HDBox

Originally designed for agricultural applications, the Deutsch J1939/12 ISO Box creates a communication pathway between an on-board CAN system and the electronic components on an attached implement. The HDBox, which holds two DT13 connectors and an HD30 Series receptacle, mounts on the vehicle and mates with an HD30 plug connector that features a breakaway coupling ring. Deutsch breakaway couplings are designed to prevent damage to the vehicle or the attached implement by fragmenting and separating from the vehicle in the event of a drive-away disconnect.





# Printed Circuit Board



## Contents

Printed Circuit Board Overview	50
PCB Connector Options	50
DRC Series	51-52
DT Family	53-55
HD10 Series	55
STRIKE Series	55
PCB Enclosures and Headers	56-57
Electronic Module Design Recommendations	58-59

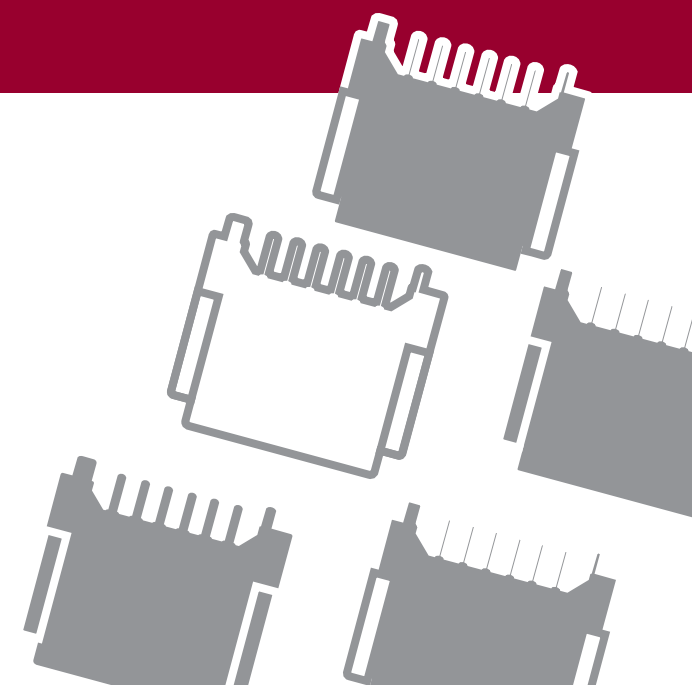



## Printed Circuit Board Overview

Deutsch Industrial printed circuit board or PCB connectors are heavy duty environmentally sealed connectors designed for wire-to-circuit board connections. Deutsch PCB connectors are built to maintain the integrity and continuity of data and power signals in harsh environments. Developed and designed for heavy duty electronically equipped vehicles, Deutsch Industrial printed circuit board connections use standard Deutsch connector bodies and will withstand dust, dirt, moisture, and vibration.

Available in a variety of styles from several different connector families, Deutsch printed circuit board connectors cover a range of pin counts from 2 to 80 and wire gauges from 10 to 22. Many of the connectors are available in straight, 90°, or solder pot options.

Deutsch PCB connectors mate with standard Deutsch plugs. With integral silicone wire seals and molded-in contacts that do not require potting or epoxy sealant, Deutsch PCB connectors are sealed, reliable, and easy to install.

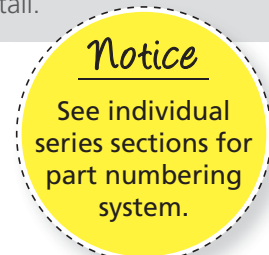

### Printed Circuit Board Connector Options

#### DRC Series

- 24, 40, 50, 60, 64, 70, 76, and 80 cavity arrangements
- Mating connectors accept 14-22 AWG

#### DT Family

- DT Series 2, 3, 4, 6, 8, and 12 cavity arrangements
- DT Series mating connectors accept 14-20 AWG
- DT Series flangeless options available
- DTM Series 8, 12, and 48 cavity arrangements
- DTM Series mating connectors accept 16-22 AWG
- DTM Series flangeless 48 way option
- DTP Series 4 cavity arrangement
- DTP Series mating connectors accept 10-14 AWG
- Some arrangements of the DT and DTM Series are available with **A**, **B**, **C**, and **D** keying options

#### HD10 Series

- 6 and 9 cavity arrangements
- Mating connectors accept 14-20 AWG

#### STRIKE Series

- 32 cavity arrangement
- Mating connectors accept 14-22 AWG

#### EEC Enclosure and Flange Receptacle

- DT Series header 12, 24, 36, and 48 cavity arrangements
- DT Series mating connectors accept 14-20 AWG
- DTM Series header 12 and 24 cavity arrangements
- DTM Series mating connectors accept 16-22 AWG
- Some arrangements of the DT and DTM Series are available with **A**, **B**, **C**, and **D** keying options



*By fixing the connectors to the board prior to soldering, pressure can be greatly reduced at the solder joint.*

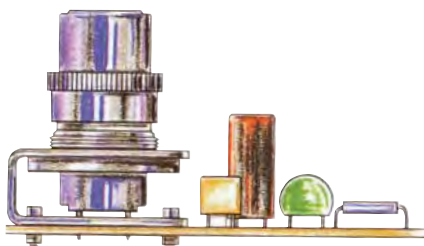



**■ DRC10 Series Straight**

**Materials**

Housing: Thermoplastic  
 Grommet: Silicone elastomer  
 Receptacle Threaded Insert: Steel  
 Contacts: Molded-in copper alloy, tin plated solder pot standard (gold optional - see modifications)

**Mating Plugs**

24 Pin: DRC16-24S\*  
 40 Pin: DRC16-40S

**Modifications**

A004: Tin plated PCB pins  
 AG02: Some terminals are gold plated

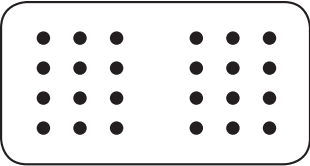

**DRC10-24P\***  
24 size 16

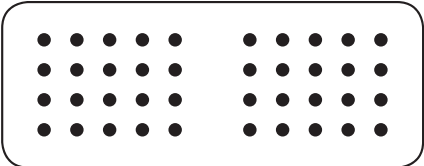

**DRC10-40P\***  
40 size 16

**■ DRC13 Series 90°**

**Materials**

Housing: Thermoplastic  
 Receptacle Threaded Insert: Steel/Brass  
 Contacts: Molded-in copper alloy, tin plated PCB pins standard (gold optional - see modifications)  
 Mounting Seal: Silicone

**Mating Plugs**

24 Pin: DRC16-24S\*  
 40 Pin: DRC18-40S\*  
 70 Pin: DRC16-70S\*

**Modifications**

C023: 5mm<sup>2</sup> threaded insert mounting holes  
 G002: Only outside terminal rows are gold plated  
 N012: One piece connector design

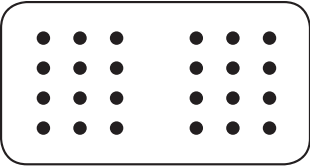

**DRC13-24P\***  
24 size 16

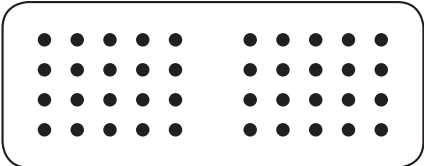

**DRC13-40P\***  
40 size 16

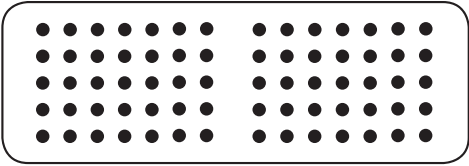

**DRC13-70P\***  
70 size 16





## ■ DRC20/22 Series Straight

### Materials

Housing: Thermoplastic

Grommet: Silicone elastomer

Receptacle Threaded Insert: Steel

Contacts: Molded-in copper alloy, gold plated mating side, tin plated PCB side (size 12 contacts are tin plated on mating and PCB sides)

Mounting Seal: Silicone rubber

### Mating Plugs

50 Pin: DRC26-50S\*\*

60 Pin: DRC26-60S\*\*

76 Pin: (2)DRC26-38S\*\*

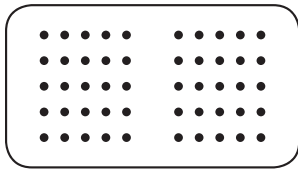

**DRC2\*-50P\***  
50 size 20

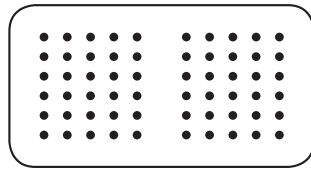

**DRC20-60P\***  
60 size 20

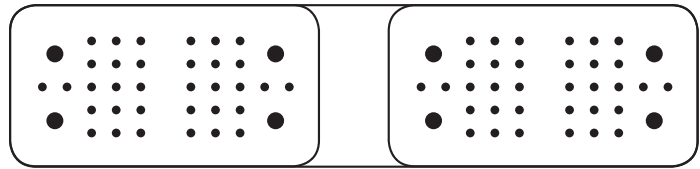

**DRC20-76P\*\*\*\***  
68 size 20, 8 size 12

## ■ DRC23 Series 90° Miniature

### Materials

Housing: Thermoplastic

Grommet: Silicone elastomer

Receptacle Threaded Insert: Steel

Contacts: Molded-in copper alloy, gold plated PCB pins standard (tin optional)

Mounting Seal: Silicone rubber

### Mating Plugs

24 Pin: DRC26-24S\*

40 Pin: DRC26-40S\*

64 Pin: DRC26-24S\*, DRC26-40S\*

80 Pin: (2)DRC26-40S\*

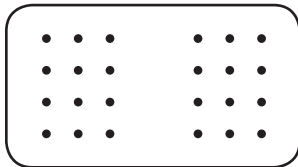

**DRC23-24\*\***  
24 size 20

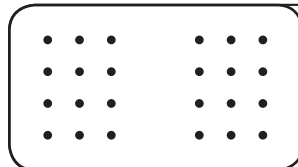

**DRC23-64\*\***  
64 size 20

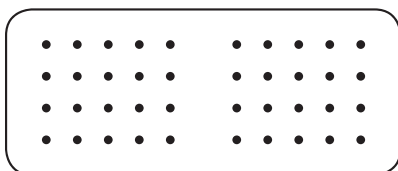
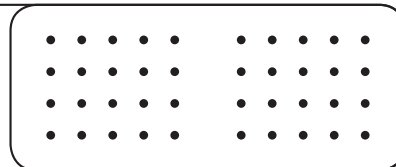

**DRC23-40\*\***  
40 size 20

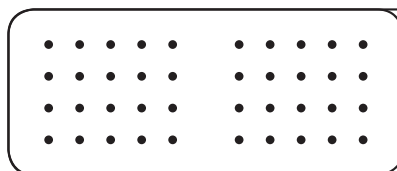

**DRC23-80\*\***  
80 size 20

## DT13/15 Series 90° or Straight

### Materials

Housing: Thermoplastic  
 Contacts: Molded-in copper alloy, tin plated (gold optional - consult factory)  
 Mounting Seal: Silicone rubber

### Mating Plugs

2 Pin: DT06-2S  
 4 Pin: DT06-4S  
 6 Pin: DT06-6S  
 8 Pin: DT06-8S\*  
 12 Pin: DT06-12S\*

### Modifications

B016: Extended shell and additional keys  
 G003: Gold plated pins

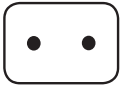

**DT1\*-2P**  
2 size 16

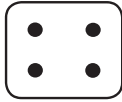

**DT1\*-4P**  
4 size 16



**DT1\*-6P**  
6 size 16



**DT1\*-08P\***  
8 size 16  
A, B, C, D



**DT1\*-12P\***  
12 size 16  
A, B, C, D



DT13



DT15

## DTM13/15 Series 90° or Straight

### Materials

Housing: Thermoplastic  
 Contacts: Molded-in copper alloy, tin plated (gold optional - consult factory)  
 Mounting Seal: Silicone rubber

### Mating Plugs

12 Pin: DTM06-12S\*

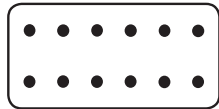

**DTM1\*-12P\***  
12 size 20  
A, B, C, D



DTM13



DTM15

## DTP10 Series Straight

### Materials

Housing: Thermoplastic  
 Contacts: Molded-in copper alloy, tin plated  
 Mounting Seal: Silicone rubber

### Mating Plugs

4 Pin: DTP06-4S



**DTP10-4P**  
4 size 12





## ■ Flangeless Part Numbering System

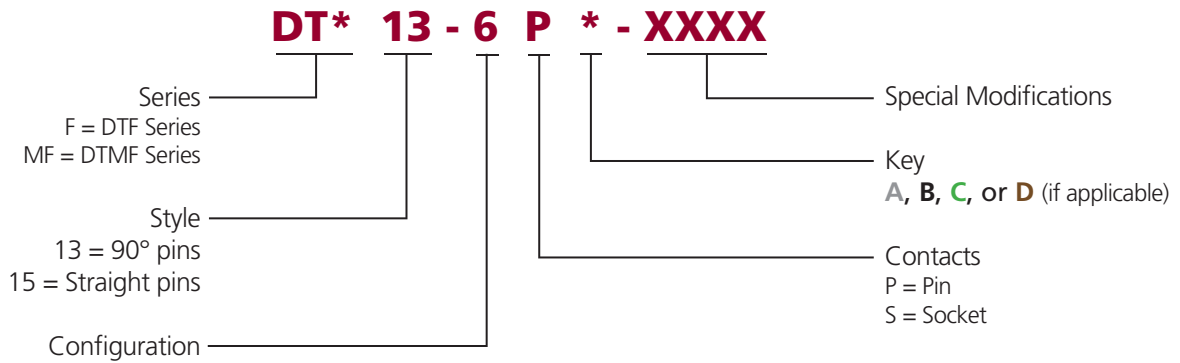

## ■ DTF13 Series Flangeless 90°

### Materials

Housing: Thermoplastic

Contacts: Molded-in copper alloy, tin plated (gold optional - consult factory)

### Mating Plugs

2 Pin: DT06-2S

3 Pin: DT06-3S

4 Pin: DT06-4S

6 Pin: DT06-6S

12 Pin: DT06-12S\*

### Modifications

G003: Gold plated pins



**DTF13-2P**  
2 size 16



**DTF13-3P**  
3 size 16

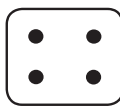

**DTF13-4P**  
4 size 16



**DTF13-6P**  
6 size 16

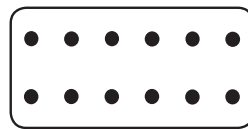

**DTF13-12P\***  
12 size 16  
A, B, C, D



## ■ DTF15 Series Flangeless Straight

### Materials

Housing: Thermoplastic

Contacts: Molded-in copper alloy, tin plated (gold optional - consult factory)

### Mating Plugs

12 Pin: DT06-12S\*

### Modifications

G003: Gold plated pins

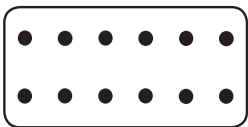

**DTF15-12P\***  
12 size 16  
A, B, C, D





## DTMF15 Series Miniature Straight

### Materials

Housing: Thermoplastic

Contacts: Molded-in copper alloy, tin plated (gold optional - consult factory)

### Mating Plugs

12 Pin: (4) DTM06-12S\*

### Modifications

B026: Alternate keying position

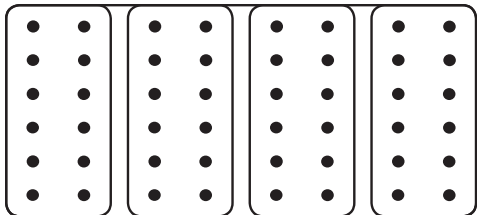

**DTMF15-48P**  
(4)12 size 20



## HD10 Series Straight

### Materials

Housing: Thermoplastic

Contacts: Molded-in copper alloy, nickel plated

Mounting Seal: Standard O-rings may be used

### Mating Plugs

6 Pin: HD16-6-96S

9 Pin: HD16-9-96S

### Modifications

N005: Straight reduced diameter pins supplied as standard

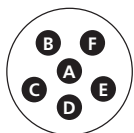

**HD10-6-96P-N005**  
6 size 16

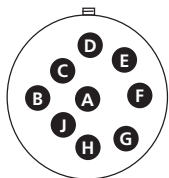

**HD10-9-96P-N005**  
9 size 16



## STRIKE13/15 Series 90° or Straight

### Materials

Housing: Thermoplastic

Contacts: Molded-in copper alloy, tin plated (gold optional - consult factory)

Mounting Seal: Silicone rubber

### Mating Plugs

32 Pin: SRK06-MD\*-32A-\*\*\*

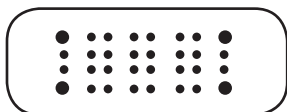

**SRK1\*-MD\*-32A-001-\*\*\*\***  
4 - Size 16  
28 - Size 20





## Printed Circuit Board Enclosures and Headers

Deutsch Industrial offers compact circuit board enclosures that accept snap-in headers. The enclosure features a through hole mounting flange on each side, as well as optional venting. Designed with space to accommodate one or more DT or DTM Series interfaces, the headers feature 90° pins. A radial flange seal provides environmental sealing to the enclosure. The headers mate with the DT and DTM standard plugs.

### DTM Series Enclosure and Header Dimensions

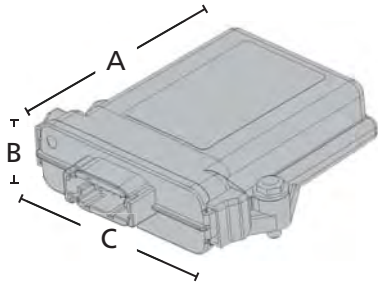

DTM Series Enclosure with Header		
Overall Length A	Overall Height B	Overall Width C
5.24 (133.03)	1.42 (36.00)	4.68 (118.80)

Dimensions are for reference only.

### DTM Header Connector

#### Materials

**Contacts:** Molded-in nickel mating side, tin plated PCB side

#### Mating Plugs

12 Pin: DTM06-12S\*  
24 Pin: (2) DTM06-12S\*

#### Modifications

GR01: DTM Series snap-in header with gold plated pins  
R008: DTM Series snap-in header



**DTM13-12P\*.\*.\*.\***  
12 size 20  
A, B, C, D



**DTM13-12PA-12PB\*.\*.\*.\***  
(2) 12 size 20  
A, B



**DTM13-12PC-12PD\*.\*.\*.\***  
(2) 12 size 20  
C, D

### DTM PCB Enclosure

#### Material

Housing: Thermoplastic

#### Venting\*

A: With vent hole  
B: Without vent hole

#### Modifications

E016: Molded in clear Ultem® material

#### Board Size

3.25" X 4"



**EEC-325X4\***



**EEC-325X4\*-E016**



**DT Series Enclosure and Header Dimensions**

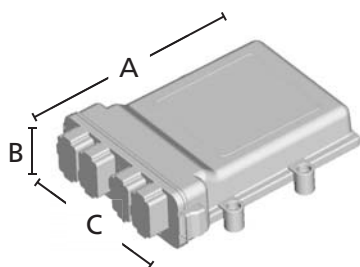

DT Series Enclosure with Header		
Overall Length A	Overall Height B	Overall Width C
7.93 (201.30)	2.15 (54.63)	6.30 (160.00)

Dimensions are for reference only.

**DT Header Connector**

**Materials**

Contacts: Molded-in tin (gold optional - consult factory)

**Mating Plugs**

- 12 Pin: DT06-12S\*
- 24 Pin: (2) DT06-12S\*
- 36 Pin: (3) DT06-12S\*
- 48 Pin: (4) DT06-12S\*

**Modifications**

- GR02: DT Series snap-in header with gold plated pins
- R015: DT Series snap-in header



**DT13-12PA-R015**  
12 size 16  
A



**DT13-24PAB-R015**  
(2) 12 size 16  
A, B



**DT13-36PABC-R015**  
(3) 12 size 16  
A, B, C



**DT13-48PABCD-R015**  
(4) 12 size 16  
A, B, C, D

*Notice*  
Keying position of receptacle must match keying position of mating plug(s).

**DT PCB Enclosure**

**Material**

Housing: Thermoplastic

**Venting\***

- A: With vent hole
- B: Without vent hole

**Board Size**

5" X 6.50"



EEC-5X650\*

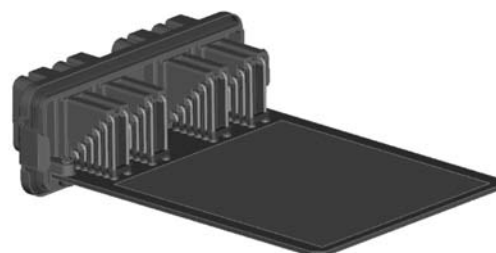
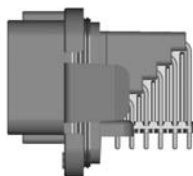





## Electronic Module Design Recommendations

Deutsch connectors are designed to handle all environmental conditions typically seen on heavy duty equipment. Design considerations have been given for temperature, vibration, and high current levels to exist simultaneously in a connector with no performance degradation.

### ■ Low Voltage Circuits

Applications with data input/output signals of 0 to 5 volts require special consideration in the terminal selection. The primary concern is ensuring the low voltage signal is carried through the circuit. To minimize signal degradation, select a gold plated terminal. Gold is a better plating choice for 0 to 5 volt applications because it does not oxidize and easily conducts lower voltage signals. Nickel and tin platings are not designed for voltage levels less than 5 volts. Terminals plated with nickel and tin will over time form a layer of oxidation on the surface of the plating that only higher voltage signals are able to break through. The small additional cost for the gold terminal can dramatically improve the reliability of the electronic system.



### ■ Air Tight Connections

In some applications, it is important to prevent air from penetrating electronic enclosures. Air can bring in water vapor and create condensation on the printed circuit board. To prevent this from happening, potting or a light conformal coating can be applied to the board.

Another method for protecting against air penetration is to seal the enclosure after it is assembled and tested. One drawback to consider is accommodating the connector interface. The flange seal prevents air penetration at the flange, but there is still a possibility for air to enter through the pin terminal area. Deutsch has several designs that offer a seal around the terminal. This can prevent any air penetration through the connector up to a 5 p.s.i. pressure differential. Consult a Deutsch representative for additional assistance.





## ■ Eliminating Long Term Vibration Problems

A critical concern when applying connectors to printed circuit boards is the long term durability as it relates to temperature cycling and vibration. All of the components including the design of the box, the pc board, the connector, and the seal must work together to account for temperature cycling and vibration. The main concern is to not have the pc board flex in service.

A typical heavy duty application uses either a straight extended pin connector or a connector with pins that are bent 90° to the axis of the connector. At the point the connector mates with the board, there is a mechanical attachment for the connector to the pc board which is independent of the solder. The engaging end of the connector normally goes through an opening in the box that houses the pc board. The connector is then attached to the box during which time a seal is used to prevent moisture intrusion into the box.

Another design pitfall is stress on the soldered terminal on the connector. To avoid these concerns, an allowance must be made to assure that stress between the pc board and connector does not interfere with the seal performance. There are a variety of methods that can be used to create a successful design. These methods include having the pc board loose in the box and then pot the box with a flexible sealant after the sealing flange is attached to the box. Another possibility would be to reflow the solder after the board and connector are mounted in the box. There are several good approaches to solving these problems and providing a trouble free installation. Consult a Deutsch representative for assistance specific to your application.







# DRC Series



## Contents

DRC Series Overview	62
Part Numbering System	62
Connector Styles	62
Dimensions	63
Mating	63
Connector Configurations	64
Accessories	65-66

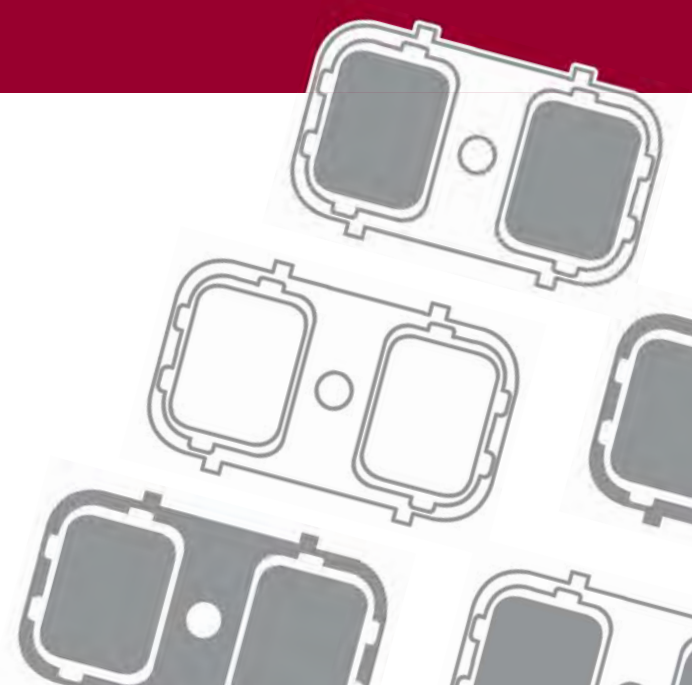

## DRC Series Overview

The environmentally sealed DRC Series is a rectangular connector series that offers insert arrangements of 24, 40, 50, 60, 64, 70, 76, and 80 cavities and accept size 12, 16, and 20 contacts. Several mounting options are available including in-line, flange mount, and PCB mount.



### Part Numbering System

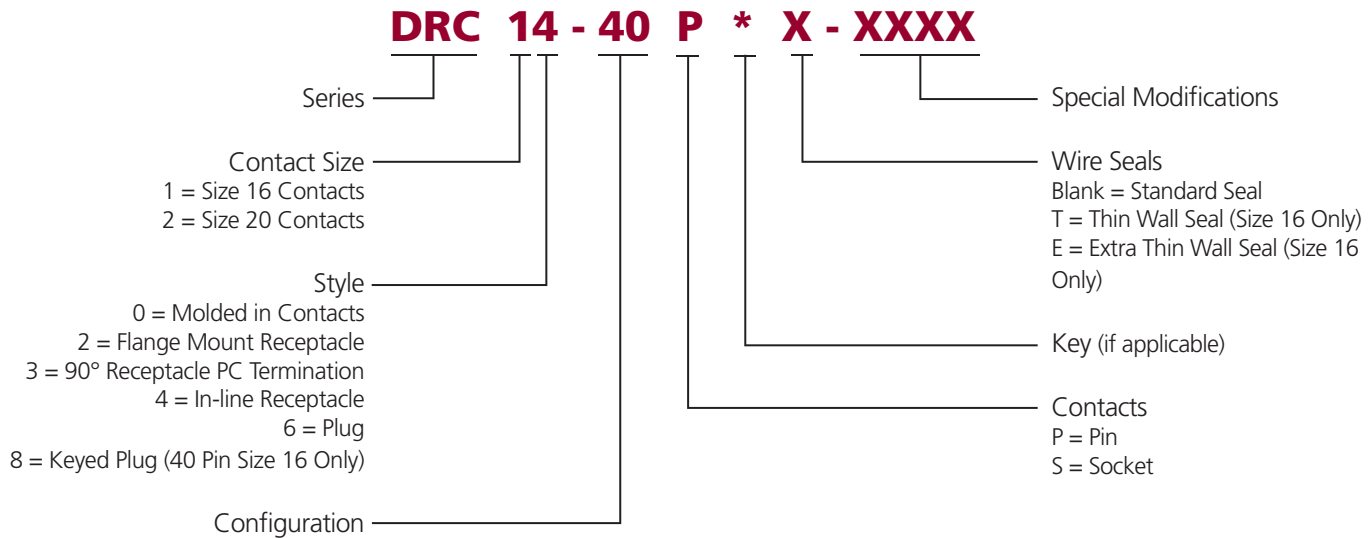

### Connector Styles

In-line Receptacle

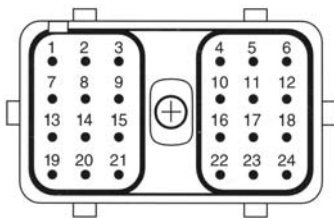

Flange Mount Receptacle

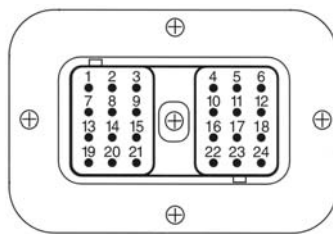

PCB Receptacle

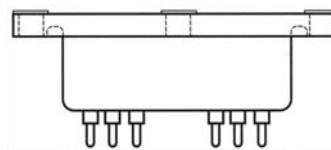

Standard Plug

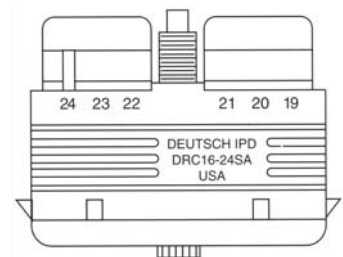

#### Notice

Several modifications are available. Consult your local Deutsch representative or the factory for specific requirements.

■ **Dimensions**



Cavity	DRC Plug			DRC Receptacle		
	Overall Length A	Overall Height B	Overall Width C	Overall Length D	Overall Height E	Overall Width F
24 (sz. 20)	1.435 (36.45)	1.244 (31.60)	2.004 (50.90)	1.785 (45.34)	1.500 (38.10)	3.104 (78.84)
24 (sz. 16)	1.600 (40.64)	1.148 (29.16)	2.100 (53.34)	1.742 (44.25)	1.202 (30.53)	2.154 (54.71)
38	1.435 (36.45)	1.274 (32.36)	2.700 (68.58)	--	--	--
40 (sz. 20)	1.380 (35.05)	1.244 (31.60)	2.700 (68.58)	1.785 (45.34)	1.500 (38.10)	3.800 (96.52)
40 (sz. 16)	1.597 (40.56)	1.202 (30.53)	2.868 (72.85)	1.699 (43.15)	1.202 (30.53)	2.908 (73.86)
50	1.435 (36.45)	1.408 (35.76)	2.700 (68.58)	--	1.987 (50.47)	3.094 (78.59)
60	1.435 (36.45)	1.448 (36.78)	2.700 (68.58)	--	2.161 (54.89)	3.094 (78.59)
64	--	--	--	1.785 (45.34)	1.500 (38.10)	5.866 (149.00)
70	1.643 (41.73)	1.421 (36.09)	4.094 (103.99)	1.757 (44.63)	1.421 (36.09)	4.094 (103.99)
76	--	--	--	1.115 (28.32)	1.827 (46.41)	5.686 (144.42)
80	--	--	--	--	1.320 (33.53)	6.363 (161.62)

Dimensions are for reference only.

■ **Mating Criteria**

The Deutsch DRC Series plugs are keyed to provide positive alignment and to prevent mis-mating.

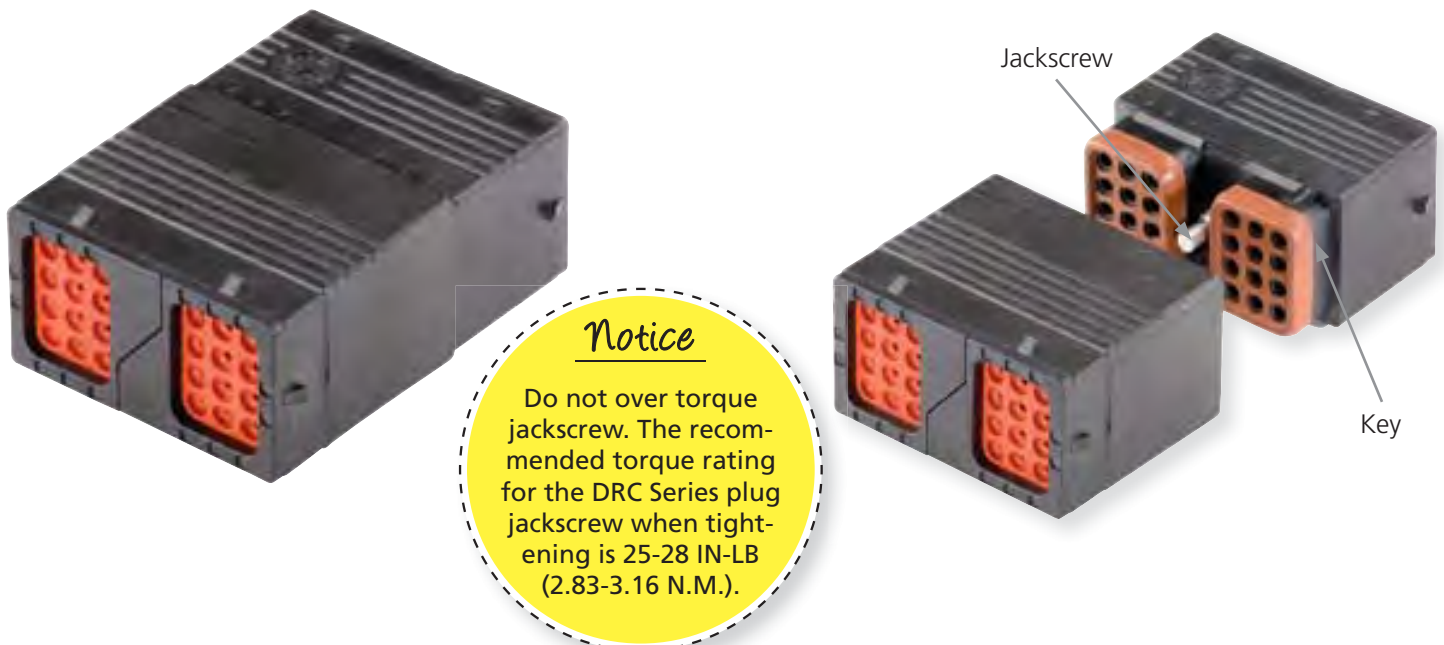



## Configurations

Connector Configurations  
 I = In-line  
 F = Flange Mount Receptacle  
 P = PCB Receptacle

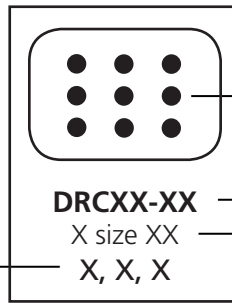

Insert Arrangement

Insert Layout

Number and Size of Cavities

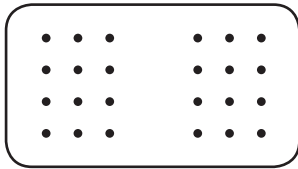

**DRC2\*-24\*\***  
 24 size 20  
 I, F, P

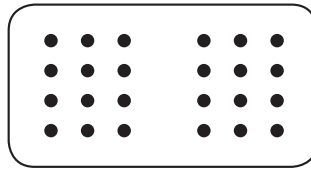

**DRC1\*-24\*\***  
 24 size 16  
 I, F, P

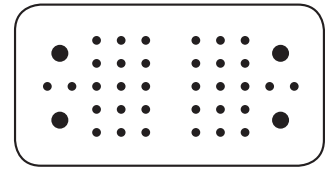

**DRC26-38\*\***  
 34 size 20, 4 size 12  
 (Plug for **DRC20-76P\*\*\*\***)

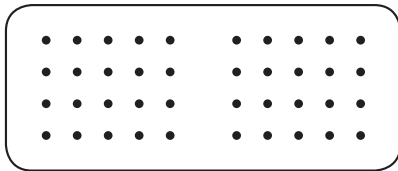

**DRC2\*-40\*\***  
 40 size 20  
 F, P

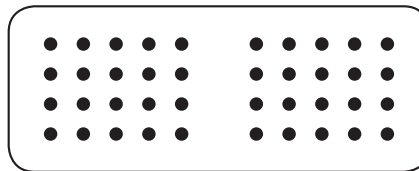

**DRC1\*-40\*\***  
 40 size 16  
 I, F, P

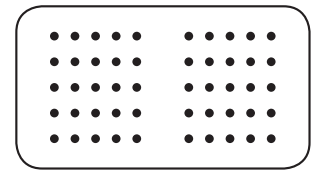

**DRC2\*-50\*\***  
 50 size 20  
 P

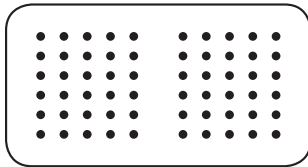

**DRC2\*-60\*\***  
 60 size 20  
 P

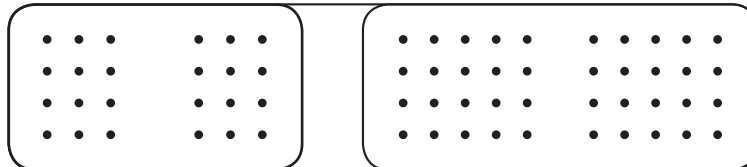

**DRC2\*-64\*\***  
 64 size 20  
 P

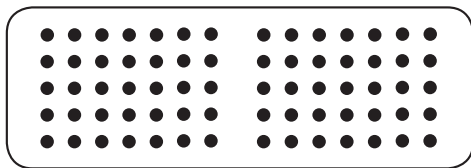

**DRC1\*-70\*\***  
 70 size 16  
 I, F, P

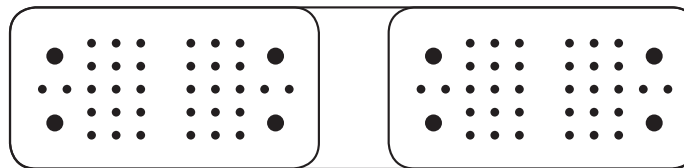

**DRC20-76P\*\*\*\***  
 68 size 20, 8 size 12  
 P

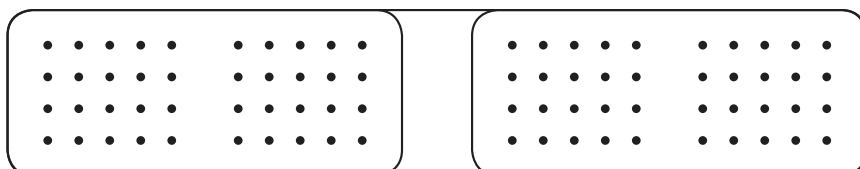

**DRC2\*-80\*\***  
 80 size 20  
 P

## Accessories

Deutsch Industrial offers several accessory items that are used to complement the connectors. The DRC Series accessories include items such as boots, gaskets, backshells, and wire routers. Accessories are designed to complete the application and meet a wide array of design requirements such as providing additional protection and offering increased aesthetics.

### ■ Backshells

The Deutsch DRC Series backshells are designed to snap onto the back of the connectors and accept convoluted tubing. The rigid, durable backshells offer a high level of protection, provide strain relief, and improve aesthetics.

#### Backshells and Wire Routers

Connector Cavities	Part Number	Description
38	0528-003-3805	90° backshell to the side, plug
38	0528-004-3805	90° backshell, plug
38	0528-005-3805	90° low profile backshell, plug
40	0515-015-4005	Wire router, plug
50	0528-001-5005	90° backshell, plug
60	0528-002-6005	90° backshell, plug
60	0528-007-6005	90° backshell to the side, plug
70	0515-029-7005	Straight wire router, plug
70	0515-031-7005	Straight wire router, plug or receptacle
70	0528-006-7005	Straight backshell, plug or receptacle, requires two halves and wire router
70	0528-012-7005	90° backshell to the side, plug or receptacle, without tubing rib
70	0525-013-7005	90° backshell to the side, plug or receptacle, with tubing rib



### ■ Boots



Boots provide a professional looking finishing touch for your Deutsch DRC Series connectors. Made of durable plastisol, these slip-on boots are not only aesthetically appealing, but also provide increased protection from dirt, paint overspray, and pressure washing. The plastisol boots are rated from -20° F to +212° F and offer a slip-on design making installation quick and easy.



#### Boot

Part Number	Description
DRC24-BT	24 way boot, size 16 contact arrangements, black
DRC26-24BT	24 way boot, size 20 contact arrangements, black
DRC40-BT	40 way boot, size 16 contact arrangements, black
DRC40-BT-90DEG	40 way boot, size 16 contact arrangements, 90° bend, black
DRC26-40BT	40 way boot, size 20 contact arrangements, black
DRC70-BT	70 way boot, size 16 contact arrangements, black



## Gaskets



Moisture, dirt, salt, sand, and road debris can all work their way into electrical panels through unsealed mounting flanges. Rated to operate in environments from -70°F to +225°F, these rugged high quality neoprene gaskets form a tight seal between the panel face and connector flange to help keep out destructive elements. The gaskets have a thickness of .125" and meet the UL-94-HBF, Mil-R-6130C, and FMVSS-302 flammability specifications.



Gasket P/N	Connector P/N
DRC24-GKT	DRC12-24P**
DRC40-GKT	DRC12-40P**
DRC70-GKT	DRC12-70P**



*Harness design should permit filling the cavities from the center out in order to provide support for the center of the harness and to allow easier connector assembly.*

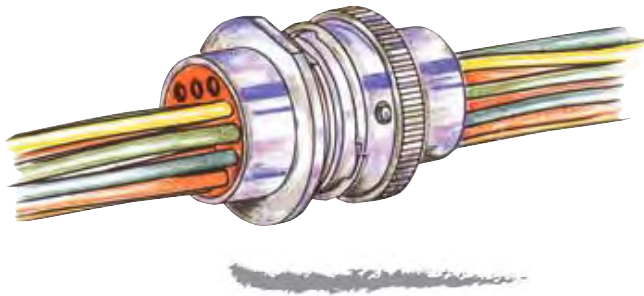





# DRB Series

## Contents

DRB Series Overview	68
Part Numbering System	68
Dimensions	68
Connector Configurations	69
Required Components	69-70
Accessories	71
How To Instructions	71-72

## DRB Series Overview

The DRB Series connectors are heavy duty connectors ideal for bulkhead applications. They are designed to accommodate multiple wire gauges and feature high pin counts, including 48, 60, 102, and 128 cavities. To increase the design flexibility, the DRB Series offers several mounting flange options and wire arrangements. The DRB Series is perfectly suited to on and off highway applications, marine, industrial, and agriculture markets in harsh environments.



### Part Numbering System

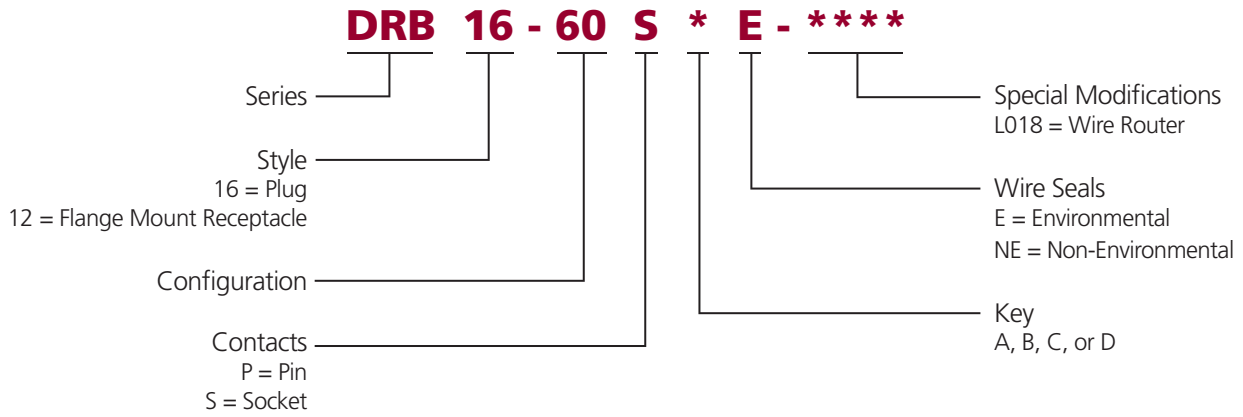

### Dimensions



Cavity	DRB Plug			DRB Receptacle		
	Overall Length A	Overall Height B	Overall Width C	Overall Length D	Overall Height E	Overall Width F
48 & 60	1.406 (35.71)	2.606 (66.19)	2.606 (66.19)	2.077 (52.76)	2.606 (66.19)	2.606 (66.19)
102	1.778 (45.16)	2.966 (75.34)	4.951 (125.76)	2.291 (58.19)	2.966 (75.34)	4.951 (125.76)
128	1.748 (44.40)	2.966 (75.34)	4.951 (125.76)	2.291 (58.19)	2.966 (75.34)	4.951 (125.76)

Dimensions are for reference only.

■ **Configurations**

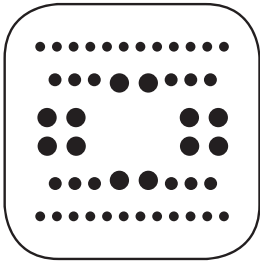

**DRB1\*-48\*\***  
 12 size 12  
 12 size 16  
 24 size 20

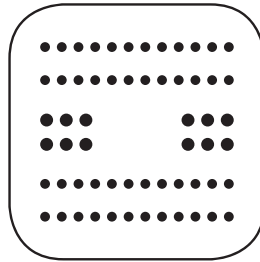

**DRB1\*-60\*\***  
 12 size 16  
 48 size 20

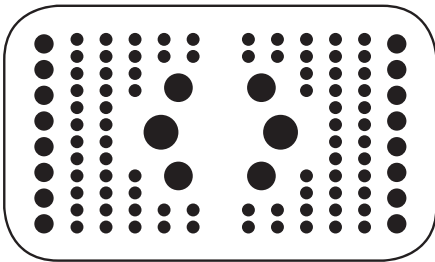

**DRB1\*-102\*\*\***  
 2 size 4  
 4 size 8  
 16 size 12  
 80 size 16

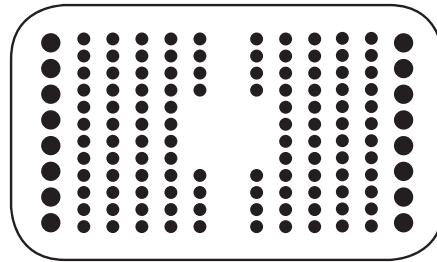

**DRB1\*-128\*\*\***  
 16 size 12  
 112 size 16





**Required Components**

■ **Required Components**

A complete DRB assembly requires a wedgelock for each plug and receptacle and a mounting flange. There are several flange options to accommodate design requirements. Please see the next page for flange options. The wedgelocks are required to ensure proper contact placement.



## ■ Flange Options

Flange	Part Number	Accept Connectors	Description
	DRBF-2*	(1) DRB 48 or 60 Way	Single mounting flange for one 48 or 60 way DRB plug and receptacle mated pair
	DRBF-3**	(2) DRB 48 or 60 Ways	Double mounting flange for any combination of two 48 or 60 way DRB plug and receptacle mated pairs
	DRBF-1*	(1) DRB 102 Way or (1) DRB 128 Way	Single mounting flange for the 102 or 128 way DRB plug and receptacle mated pair
	DRBM-2*	(1) DRB 102 Way or (1) DRB 128 Way	Single mounting flange for the 102 or 128 way DRB plug and receptacle mated pair, includes two 125 amp mounting posts

\*A, B, C, D keying available

## ■ Secondary Wedgelocks

Deutsch DRB electrical connectors require secondary wedgelocks which are sold separately. The wedgelocks ensure proper contact alignment and offer keying options within each connector. Secondary wedgelocks are assembled at the mating interfaces and click into place.

Receptacle	
WB-48P*	Wedgelock for 48 way receptacle
WB-60P*	Wedgelock for 60 way receptacle
WB-51P*L	Left wedgelock for 102 way receptacle
WB-51P*R	Right wedgelock for 102 way receptacle
WB-64P*	Wedgelock for 128 way receptacle (requires two)

Plug	
WB-48S*	Wedgelock for 48 way plug
WB-60S*	Wedgelock for 60 way plug
WB-51S*L	Left wedgelock for 102 way plug
WB-51S*R	Right wedgelock for 102 way plug
WB-64S*	Wedgelock for 128 way plug (requires two)

\*A, B, C, D keying available



## Accessories

### Boots



Boots provide a professional looking finishing touch for Deutsch DRB Series connectors. Made of durable plastisol, these slip-on boots are not only aesthetically appealing, but also provide increased protection from dirt, paint overspray, and pressure washing. The plastisol boots are rated from -20° F to +212° F and offer a slip-on design making installation quick and easy.



#### Boot

Part Number	Description
DRB48/60-BT	48 way plug or receptacle boot, black
DRB48/60-BT	60 way plug or receptacle boot, black
DRB102-BT	102/128 way plug or receptacle boot, black

## How To Instructions

### Assembly



**Step 1:**  
Wedgelocks should be pressed firmly in place, with only a slight gap showing between the wedgelock and connector.



**Step 2:**  
If the wedgelock will not go all the way in, check to make sure all of the contacts are properly seated.



**Step 3:**  
Contacts should be fully inserted into the connector, with the locking fingers in place under the shoulder of the contact. If a contact is not fully inserted, the retention finger will prevent the wedgelock from pressing into place.



**Step 4:**  
When mating the plug with the receptacle, ensure that the plug is not being pulled into the receptacle at an angle by the jackscrew.

Improper assembly can cause the jackscrew to be stripped during assembly. To prevent damage, the jackscrew will strip out before the threads in the connector are damaged. If the jackscrew becomes stripped, please replace the jackscrew and the push nut.

#### Notice

Do not over torque jackscrew. The recommended torque rating for the DRB Series plug jackscrew when tightening is 30-35 IN-LB (3.38-3.95 N.M.).

## ■ Contact Insertion

---



**Step 1:**  
Hold connector with rear grommet/wire router cap facing you.



**Step 2:**  
Push contact straight into contact cavity until a click is heard/felt. A slight tug will ensure the contact is inserted correctly.



**Step 3:**  
Once all contacts are in place, insert wedgelock by lining up the keyway. The wedgelock will press into place.

## ■ Contact Removal

---



**Step 1:**  
Remove wedgelock using a screwdriver. Pull wedgelock straight out.



**Step 2:**  
To remove contacts, gently pull wire backwards, while at the same time releasing the locking finger by moving it away from the contact with a screwdriver.



# HD10 Series

## Contents

HD10 Series Overview	74
Part Numbering System	74
Dimensions	74
Connector Styles	75
Configurations	75
Special Modifications	75
Accessories	76-78



## HD10 Series Overview

The HD10 is an environmentally sealed, thermoplastic cylindrical connector series and offers arrangements from 3 to 9 cavities. All HD10 connectors are available either in-line or flanged and accept size 12 or 16 contacts, or a combination of size 16 and size 4 contacts. The HD10 Series is heavily used for diagnostic connectors, eliminates problems associated with assembly and maintenance time, and is designed for long service life.



### Part Numbering System

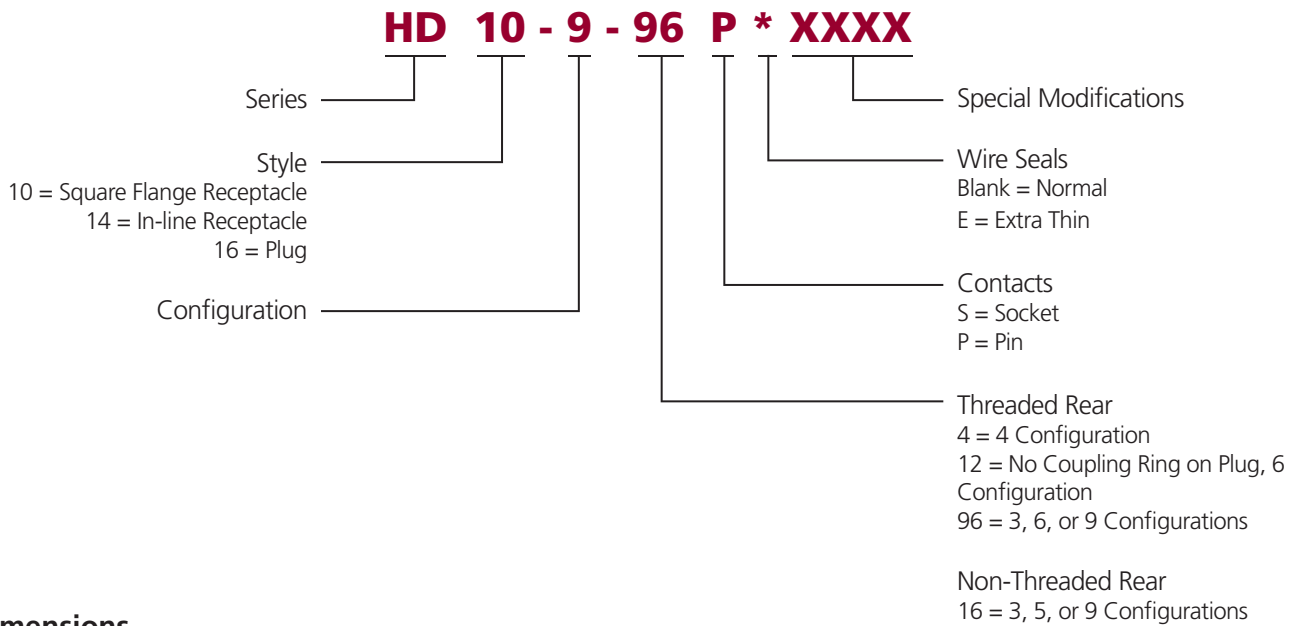

### Dimensions

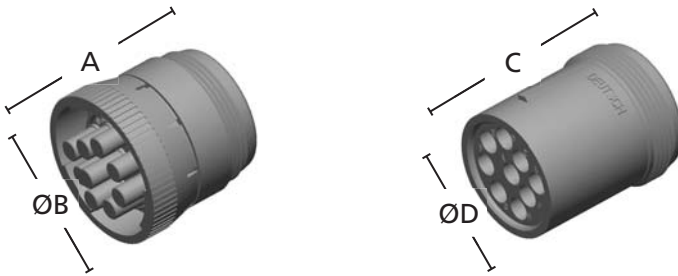

Cavity	HD10 Plug		HD10 Receptacle	
	Overall Length A	Overall Height ØB	Overall Length C	Overall Height ØD
3	1.609 (40.87)	1.069 (27.15)	1.639 (41.63)	.851 (21.62)
4	1.639 (41.63)	1.595 (40.51)	1.639 (41.63)	1.281 (32.54)
5	1.609 (40.87)	1.218 (30.94)	1.639 (41.63)	1.001 (25.43)
6	1.619 (41.12)	1.453 (36.91)	1.639 (41.63)	1.141 (28.98)
9	1.609 (40.87)	1.593 (40.47)	1.639 (41.63)	1.281 (32.54)

Dimensions are for reference only.





**Connector Styles**

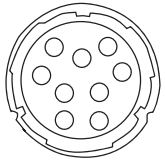

Plug HD16

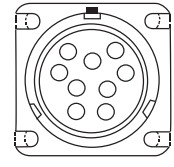

Square Flange Receptacle HD10

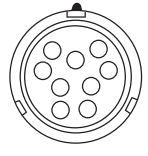

In-line Receptacle HD14

**Configurations**

Cavity identification shown from rear of receptacle

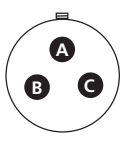

**3-16/3-96\***  
3 size 16

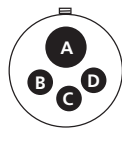

**4-4**  
1 size 4  
3 size 16

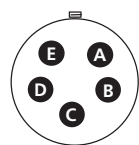

**5-16**  
5 size 16

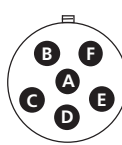

**6-12**  
6 size 12

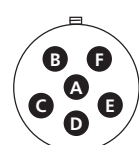

**6-96**  
6 size 16

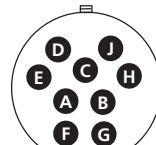

**9-16**  
9 size 16

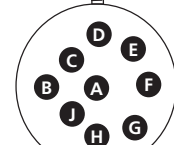

**9-96\***  
9 size 16

\*Also available in an "E" seal

**Special Modifications**

The HD10 Series connectors offer several modifications to enhance the design flexibility and meet application specific needs. Options include the addition of a coupling ring and connector body color, just to mention a few. By combining the HD10 Series connectors with the available modifications and accessories, the design possibilities are increased.

**B010 Modification**

The B010 modification provides the addition of a coupling ring used for mating. The B010 modification is only available on the HD16-6-12S-B010 connector.



**Notice**  
Please see Common Contact section for extended PCB pins.

**E004 Modification**

The E004 modification changes the HD10 Series connector from the standard gray to a black connector body.



## Accessories

Deutsch Industrial offers several accessory items that are used to complement the connectors. The HD10 Series accessories include items such as boots, backshells, gaskets, and protective caps. Accessories are designed to complete the application and meet a wide array of design requirements such as solutions for mounting, providing additional protection, and offering increased aesthetics.

### ■ Backshells



The Deutsch HD10 Series backshells are designed to screw onto all threaded HD10 connectors. Rated for temperatures from -40°C to +134°C, the rigid, durable backshells offer a high level of protection, provide strain relief, and improve aesthetics.

#### Backshell and Compression Nut Assembly

Connector Part Number	Cable Diameter	Backshell Part Number	Compression Nut Part Number
<b>Deutsch HD10 Series 3 Way</b> HD1*-3-96*	.187-.300	M902-2131	M902-2041
	.300-.430	M902-2132	M902-2042
<b>Deutsch HD10 Series 6 Way</b> HD1*-6-96* HD1*-6-12*	.187-.300	M902-2161	M902-2041
	.300-.430	M902-2162	M902-2042
	.430-.570	M902-2163	M902-2053
	.570-.710	M902-2164	M902-2054
<b>Deutsch HD10 Series 9 Way</b> HD1*-9-96* HD1*-9-1939**	.187-.300	M902-2191	M902-2041
	.300-.430	M902-2192	M902-2042
	.430-.570	M902-2193	M902-2053
	.570-.710	M902-2194	M902-2054

Backshell Technical Specifications:

Material - PC/PET Polyester Blend, UV-Stabilized, Flame Retardant, Black  
Flammability - UL94-VO, Weatherability - UL746C

### ■ Strain Relief

Deutsch HD10 Series strain reliefs are designed to screw onto threaded 3, 4, 6, and 9 cavity HD10 connectors. The rigid, durable strain reliefs offer a high level of protection, provide tie wrap holders to reduce the strain from the wires, and improve aesthetics.



#### HD18 Backshell

Part Number	Description
HD18-003	3 cavity strain relief
HD18-006	6 cavity strain relief
HD18-009	4 or 9 cavity strain relief



Attaching the connector to a structure eliminates straining the electrical system in service.



## ■ Protective Dust Caps

The HD10 Series protective dust caps provide an environmental seal and are used to protect the connector interface when the connector is not mated.



### HDC14 Protective Cap for Plug

Part Number	Description
HDC14-3	3 cavity plug protective cap
HDC14-6	6 cavity plug protective cap
HDC14-9	9 cavity plug protective cap

### HDC16 Protective Cap for Receptacle

Part Number	Description
HDC16-3	3 cavity receptacle protective cap
HDC16-5	5 cavity receptacle protective cap
HDC16-6	6 cavity receptacle protective cap
HDC16-9	9 cavity receptacle protective cap

## ■ Boots



Boots provide a professional looking finishing touch for Deutsch HD10 Series connectors. Made of durable plastisol, these slip-on boots are not only aesthetically appealing, but also provide increased protection from dirt, paint overspray, and pressure washing. The plastisol boots are rated from -20° F to +212° F and offer a slip-on design making installation quick and easy.



### Boot

Part Number	Description
HD10-3BT	3 cavity boot, gray
HD10-5BT	5 cavity boot, gray
HD10-5BT-BK	5 cavity boot, black
HD10-6BT	6 cavity boot, gray
HD10-9BT	9 cavity boot, gray
HD10-9BT-BK	9 cavity boot, black

## ■ Gaskets



Moisture, dirt, salt, sand, and road debris can all work their way into electrical panels through unsealed mounting flanges. Rated to operate in environments from -70°F to +225°F, these rugged high quality neoprene gaskets form a tight seal between the panel face and connector flange to help keep out destructive elements. The gaskets have a thickness of .125" and meet the UL-94-HBF, Mil-R-6130C, and FMVSS-302 flammability specifications.



Gasket P/N	Connector P/N
HD10-3-GKT	HD10-3-****
HD10-5-GKT	HD10-5-****
HD10-6-GKT	HD10-6-****
HD10-9-GKT	HD10-9-****



## Lanyards





Lanyards are available in Nitrile or Nylon coated steel and designed for use with protective dust caps.



HDC9-JDL082397  
(Deutsch's HDC16-9-E004 dust cap assembled with JDL082397)



HDC16-9-L47N  
(Deutsch's HDC16-9 dust cap assembled with L47N-600-1)

Lanyard	Material	Material Diameter	Length	Minimum Breaking Strength
 JDL082397	Nitrile o-ring, 3M heat shrink with thermoplastic adhesive	.07 inches	5.31 inches	---
 L47N-600-1	7 x 7 galvanized steel cable coated with clear nylon	.047 inches	6 inches	270 lbs.

Dimensions are for reference only.

## Dust Cap/Lanyard Assemblies

Part Number*	Used On	Connector Cavities	Lanyard Material	Dust Cap Color
HDC14-3-JDL	Plug	3	Nitrile	Gray
HDC14-6-JDL	Plug	6	Nitrile	Gray
HDC14-6-LA	Plug	6	Steel	Gray
HDC14-9-JDL	Plug	9	Nitrile	Gray
HDC16-3-JDL	Receptacle	3	Nitrile	Gray
HDC16-3-LA	Receptacle	3	Steel	Gray
HDC16-5-LA	Receptacle	5	Steel	Gray
HDC16-6-JDL	Receptacle	6	Nitrile	Gray
HDC16-6-LA	Receptacle	6	Steel	Gray
HDC16-9-JDL	Receptacle	9	Nitrile	Gray
HDC9-JDL082397	Receptacle	9	Nitrile	Black
HDC16-9-L47N	Receptacle	9	Steel	Gray
HDC16-9-E004-L47N	Receptacle	9	Steel	Black

\*Other dust cap/lanyard assemblies may be available



# HD30 & HDP20 Series



## Contents

HD30 & HDP20 Series Overview	80
Dimensions	80
Part Numbering System	81
Configurations	82-83
Wire Insulation	83
Special Modifications	84-85
Accessories	85-87

Mounting	88
How To Instructions	89-90





## HD30 & HDP20 Series Overview

Designed specifically for the truck, bus, and off-highway industry, the HD30 & HDP20 Series are heavy duty, environmentally sealed, multi-pin circular connectors. Available in metal or thermoplastic housings, these connectors offer multiple pin configurations that accept contact sizes 4 through 20.

The HD30 is a metal shell while the HDP20 Series shells are thermoplastic. Both feature quick connect-disconnect bayonet coupling, single hole bulkhead mounting, silicone seals, and a rear insertion/rear removal contact system.

### HD30 Series Overview



The Deutsch HD30 Series connectors are constructed from a metal shell developed to meet the needs of the heavy duty equipment and transportation industries. The HD30 features include quick connect-disconnect bayonet coupling, single hole bulkhead mounting, silicone seals, and a rear insertion/rear removal contact system.

### HDP20 Series Overview

The HDP20 Series is a heavy duty rated, environmentally sealed, composite shell, multi-pin connector. The composite thermoplastic shell is ideal in applications where chemicals can damage a connector housing. HDP20 features quick connect-disconnect bayonet coupling, single hole bulkhead mounting, silicone seals, and a rear insertion/rear removal contact system.



### HD30 & HDP20 Series Dimensions

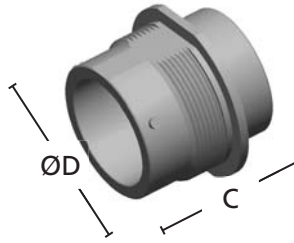
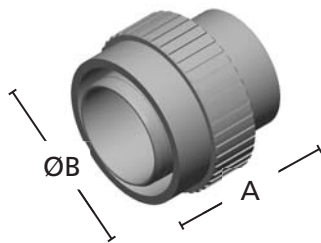

Shell Size	HD/HDP Plug		HD/HDP Receptacle	
	Overall Length A	Overall Height ØB	Overall Length C	Overall Height ØD
18	1.521 (38.63)	1.700 (43.17)	1.648 (41.86)	1.750 (44.45)
24	1.521 (38.63)	1.950 (49.53)	1.648 (41.86)	2.000 (50.80)

Dimensions are for reference only.

■ HD30 Series Part Numbering System

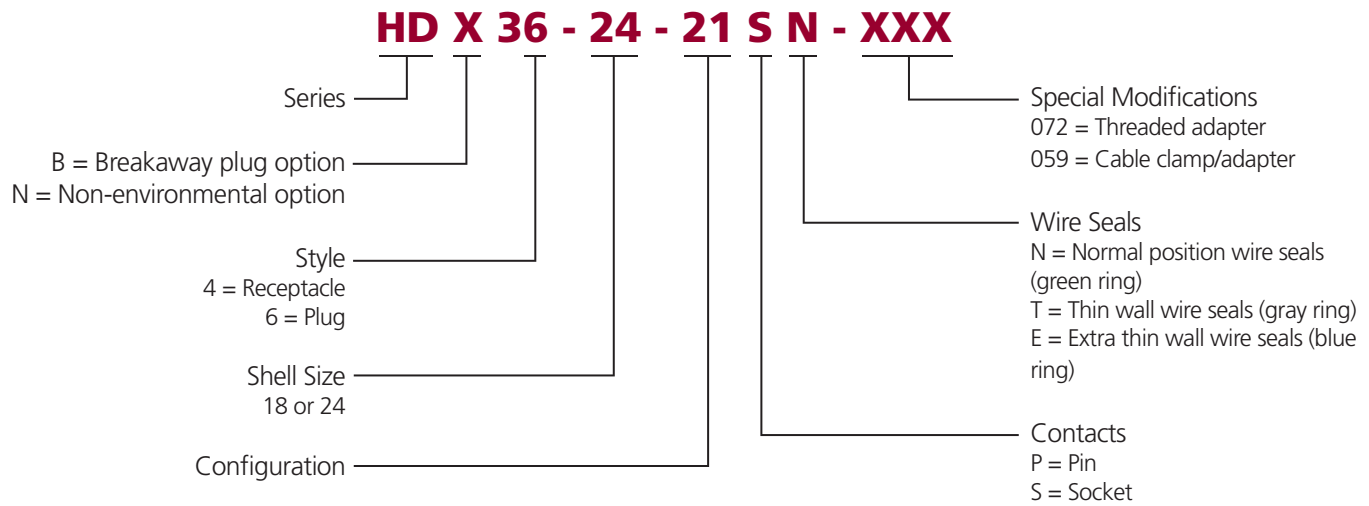

*Notice*

Reverse arrangements are available as a keying option for the HD30 & HDP20 Series.

■ HDP20 Series Part Numbering System

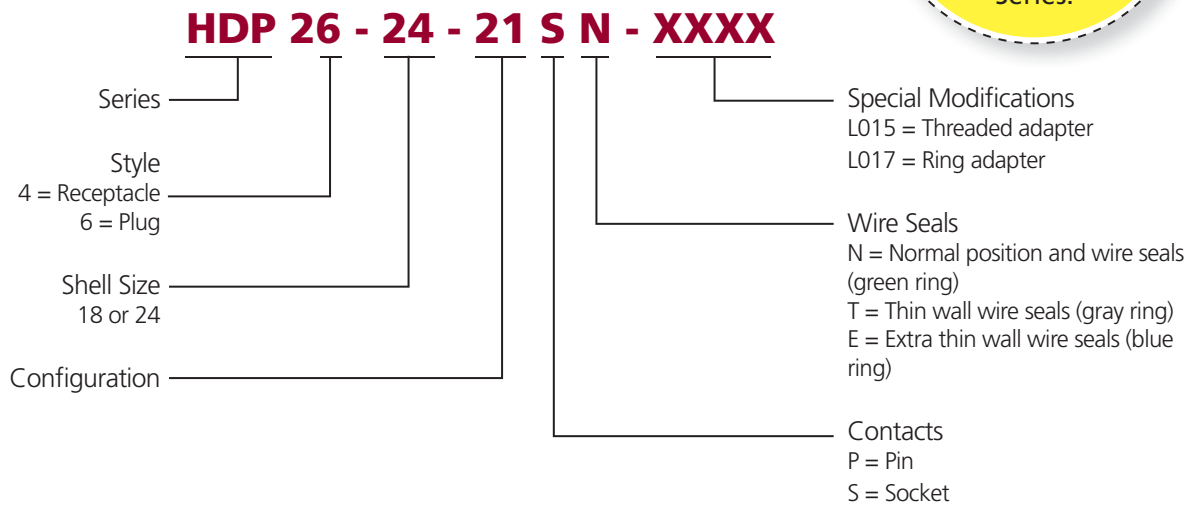

*helpful hint*

Making the socket contact side the "hot side" can reduce the danger of electric shock.

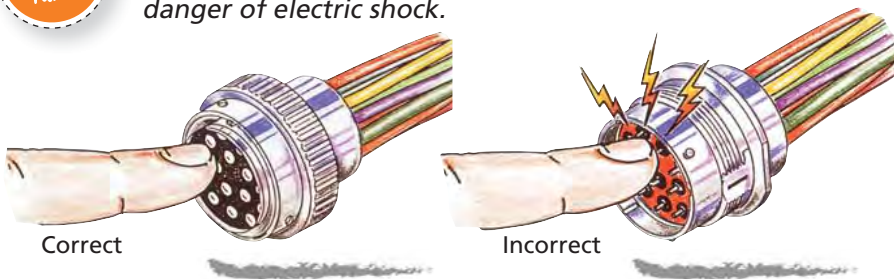





## HD30 & HDP20 Series Configurations

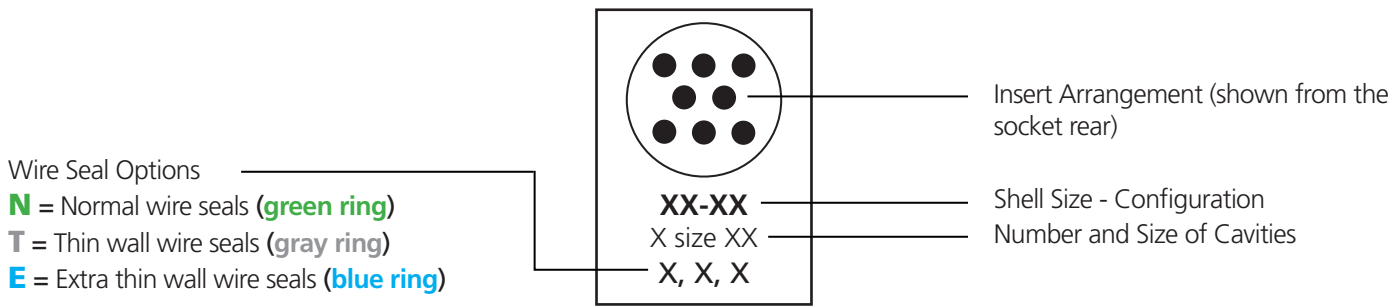

### 18 Shell Size Configurations

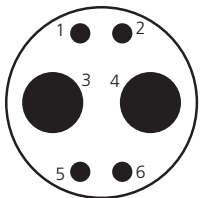

**18-6**  
2 size 4 & 4 size 16  
**N, E**

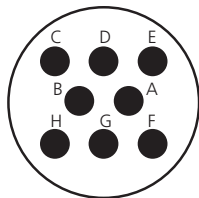

**18-8**  
8 size 12  
**N, E**

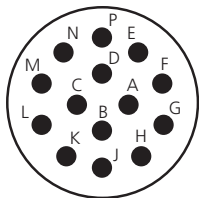

**18-14**  
14 size 16  
**N, T, E**

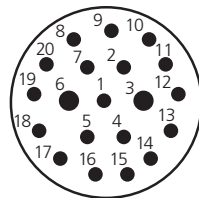

**18-20**  
2 size 16 & 18 size 20  
**N, E**

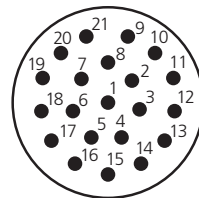

**18-21**  
21 size 20  
**N**

### 24 Shell Size Configurations

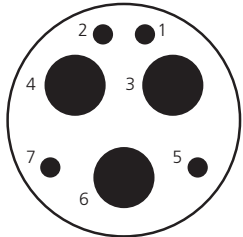

**24-7(-C038 only)**  
3 size 4† & 4 size 16  
**N**

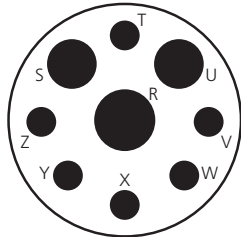

**24-9**  
1 size 4, 2 size 8  
& 6 size 12  
**N, E**

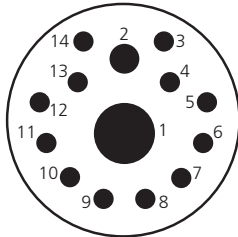

**24-14**  
1 size 4, 1 size 12  
& 12 size 16  
**N, E**

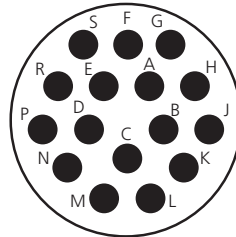

**24-16**  
16 size 12  
**N, E**

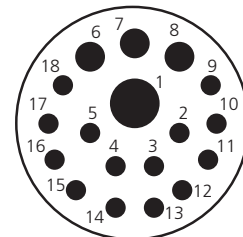

**24-18**  
1 size 8, 3 size 12  
& 14 size 16  
**N, E**

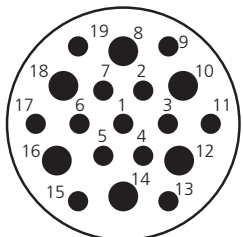

**24-19**  
6 size 12  
& 13 size 16  
**N, E**

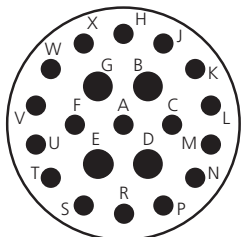

**24-21**  
4 size 12  
& 17 size 16  
**N, E**

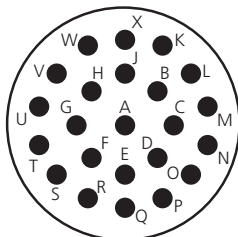

**24-23**  
23 size 16  
**N, T, E**

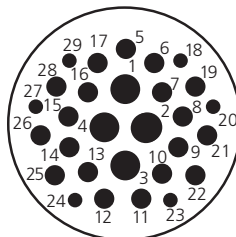

**24-29**  
4 size 12, 19 size 16  
& 6 size 20  
**E\***

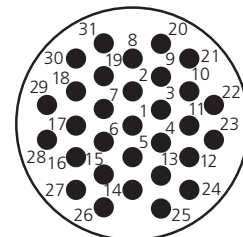

**24-31**  
31 size 16  
**T\*, E\***

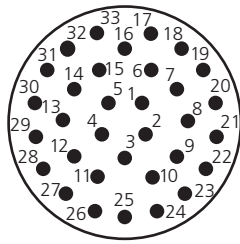

**24-33**  
33 size 20  
**N**

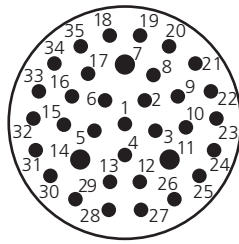

**24-35**  
3 size 16 & 32 size 20  
**N, E**

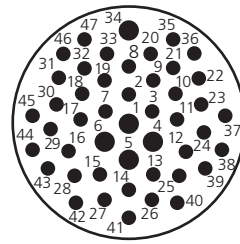

**24-47**  
5 size 16 & 42 size 20  
**E\***

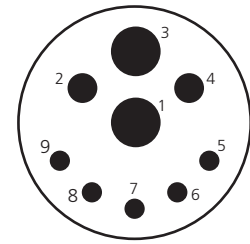

**24-91-P064‡**  
2 size 8, 2 size 12 &  
5 size 16  
**N, E**

\*Modified seal, see drawing

‡Without P064 modification, plug cavities 4 and 5 are internally connected

**Wire Insulation**

Contact Size	Recommended Wire Insulation O.D.		
	N Seal Green Ring	T Seal Gray Ring	E Seal Blue Ring
20	.040-.095 (1.02-2.41)	.040-.095 (1.02-2.41)	.040-.095 (1.02-2.41)
16	.100-.134 (2.54-3.40)	.088-.134 (2.23-3.40)	.053-.120 (1.35-3.05)
12	.134-.170 (3.40-4.32)	.113-.170 (2.87-4.32)	.097-.158 (2.46-4.01)
8	.190-.240 (4.83-6.10)	.170-.240 (4.32-6.10)	.135-.220 (3.43-5.59)
4	.280-.292 (7.11-7.42)	.261-.292 (6.63-7.42)	.261-.292 (6.63-7.42)

**Connector Identification**



Mating Slot Positions

Color Coded Ring



Color code is visible from the rear of the receptacle or plug.

- Green:** Normal Seal
- Gray:** Thin Wall Seal
- Blue:** Extra Thin Seal

*Notice*

Undersized wire insulation is a major cause for leakage.



## Special Modifications

The HD30 & HDP20 Series connectors offer several modifications to enhance design flexibility and meet application specific needs. Options include breakaway plugs, adapters, and high amperage options just to mention a few. By combining the HD30 & HDP20 Series connectors with the available modifications and accessories, the design possibilities are greatly expanded.

### ■ HDB - Breakaway Plug (HD30 Series Only)



The HDB is designed to provide an emergency disconnect between farm tractors and implements that require power connections. The HDB breakaway plug is designed to break the connection before damaging the wiring system. These plugs can be specified with pin or socket contacts and connect only with the HD30 Series receptacles. As an added design convenience, the HDB is also available with an optional cable clamp (059 mod). Breakaway function occurs at an axial load of 50-100 lbs.

### ■ L015/L017 Modifications

The L015 threaded adapter and L017 ring adapter modifications are available for the Deutsch HDP20 Series. These adapter modifications provide simple, low cost assembly solutions for applications that require a backshell or conduit. The L015/L017 modifications must be ordered with the initial connector, as it is factory assembled. The adapters are designed to be used with the backshell of your choice.

- The L015 threaded adapter is available on size 24 shells in the HDP20 Series.
- The L017 ring adapter is available on size 24 or size 18 shells in the HDP20 Series.



L015  
Threaded Adapter



L017  
Ring Adapter

### ■ C030 Modification



Originally designed for multiplexing and battery cable applications, Deutsch's C030 modification is an environmentally sealed, heavy duty two cavity connector that accepts size 4 solid contacts rated up to 100 amps for each cavity.

The C030 modification is available in size 18 shell in both metal (HD30 Series) and thermoplastic (HDP20 Series) to provide the perfect solution to all of your heavy wire gauge applications.

**■ Cable Clamp/Backshell Modifications**

Deutsch cable clamps provide positive support to the wire bundle while reducing strain on the connector. The backshell is available with or without drain holes.



Part Number Suffix	Description
-072	Adapter only
-059	Adapter and cable clamp assembly with drain holes
-L006	Adapter and cable clamp assembly without drain holes

**Accessories**

Deutsch Industrial offers several accessory items that are used to complement the connectors. The HD30 & HDP20 family accessories include items such as boots, backshells, gaskets, and protective caps. Accessories are designed to complete the application and meet a wide array of design requirements such as solutions for mounting, providing additional protection, and offering increased aesthetics.

**■ Protective Dust Caps**

Protective caps are available for both plug and receptacle halves of the connectors. The metal caps, for use with the HD30 Series, come with a mounting chain and are used to protect the connector while not mated. The thermoplastic caps, for use with the HDP20 Series, are available with or without a lanyard.



Shell Size	Part Number*	Connector
18	HDC26-18	Plug cap for receptacle protection
24	HDC26-24	Plug cap for receptacle protection
18	HDC36-18	Plug cap for receptacle protection
24	HDC36-24	Plug cap for receptacle protection
18	HDC34-18	Receptacle cap for plug protection
24	HDC34-24	Receptacle cap for plug protection

\*To order HD30(HD3\*-\*\*) protective caps without the mounting chain, add -1E to the end of the part number

**■ Boots**



Boots provide a professional looking finishing touch for the Deutsch HD30 & HDP20 family of connectors. Made of durable plastisol, these slip-on boots are not only aesthetically appealing, but also provide increased protection from dirt, paint overspray, and pressure washing. The plastisol boots are rated from -20° F to +212° F and offer a slip-on design making installation quick and easy.



**Boot**

Part Number	Description
HD30-18BT	18 shell size boot, gray
LC-90BT-HT	18 shell size boot, 90° bend, high temperature material, yellow
HD30-18BT-90-BK	18 shell size boot, 90° bend, black
HD30-24BT	24 shell size boot, gray
HD30-24BT-BK	24 shell size boot, black
MT-90BT-HT-24	24 shell size boot, 90° bend, high temperature material, yellow
HD30-24BT-90-BK	24 shell size boot, 90° bend, black



## Strain Relief

The Deutsch HD30 & HDP20 Series offer several backshell options to meet your design needs. Backshell options include straight or 90° and plastic or metal. The metal backshells work best with the HD30 Series. It is attached to the rear of the connector using an adjustable screw and is secured to the wire bundle with the use of a tie wrap. The plastic backshells work best with the HDP20 Series and attach to the rear of the connector with either a clamshell snap closure or by screwing them on to a threaded adapter. The rigid, durable backshells offer a high level of protection, provide strain relief, and improve aesthetics.



### HD30 Series Backshell

Shell Size	Orientation	Part Number
18	Straight	WHDS-18-1
24		WHDS-24-1
18	90°	WHDS-18-2
24		WHDS-24-2



### HDP20 Series L017 Backshell

Shell Size	Orientation	Part Number	Conduit Size
18	Straight	2428-016-1805	13, 17, 19 (mm) NW
	90°	2428-015-1805	13, 17, 19 (mm) NW
24	Straight	2428-008-2405	1"
	90°	2428-004-2405	1"
24	Straight	2428-010-2405	17, 19, 23, 26 (mm) NW
	90°	2428-011-2405	17, 19, 23, 26 (mm) NW

NW = Nominal Width of the conduit's inside diameter. See drawings for full specifications.



Seal Ring

Cap Nut

### HDP20 Series L015 Conduit Adapter

Shell Size	L015 Conduit Adapter Part Numbers		Conduit Size
24	Seal Ring: SRN21	Cap Nut: CN21	22 (mm) NW

## Backshells for L015 Modification



The Deutsch HDP20 Series backshells are designed to screw onto connectors with the L015 modification, which adds a threaded adapter. Rated for temperatures from -40°C to +134°C, the rigid, durable backshells offer a high level of protection, provide strain relief, and improve aesthetics.



Backshell

Compression Nut

### HDP20 Series L015 Backshell

Shell Size	Cable Diameter	Backshell	Compression Nut
24	.430-.570	M902-2243	M902-2053
	.570-.710	M902-2244	M902-2054

#### Backshell Technical Specifications:

Material - PC/PET Polyester Blend, UV-Stabilized, Flame Retardant, Black  
Flammability - UL94-VO, Weatherability - UL746C

**Mounting Hardware**

Deutsch offers lockwashers and panel nuts to aid in mounting the HD30 and HDP20 Series connectors. The lockwashers are used to add tension between the threads and the nut to provide a secure mount. The lockwasher and the panel nut should be used together.

**Panel Lockwasher**

Shell Size	Part Number	ØA	B
18	114021*	1.886	.062 (1.57)
	2414-002-1886**	(47.90)	.020 (0.51)
24	112264*	2.074	.062 (1.57)
	2414-001-2486**	(52.68)	.020 (0.51)

Dimensions are for reference only.  
 \*For use on HD30 Series only.  
 \*\*For use on HDP20 Series only.

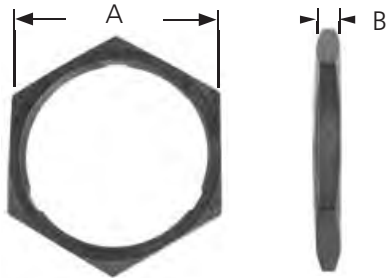
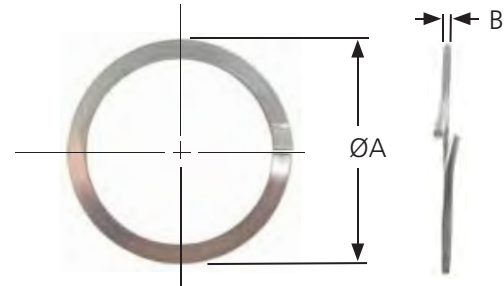

**Panel Nut**

Shell Size	Part Number	Material	A	B
18	114020-90*	Metal	1.685	.178 (4.52)
	2411-002-1805	Plastic	(42.80)	.250 (6.35)
24	112263-90*	Metal	1.875	.178 (4.52)
	2411-001-2405	Plastic	(47.63)	.250 (6.35)

Dimensions are for reference only.  
 \*For use on HD30 Series only.

**Panel Nut Mounting Torque**



HD30 18 Shell Size	260-280 IN. LB. (29.4-31.6 N.M.)
HDP20 18 Shell Size	45-55 IN. LB. (5.1-6.1 N.M.)
HD30 24 Shell Size	350-375 IN. LB. (39.5-42.6 N.M.)
HDP20 24 Shell Size	65-75 IN. LB. (7.4-8.4 N.M.)

**Gaskets**



Moisture, dirt, salt, sand, and road debris can all work their way into electrical panels through unsealed mounting flanges. Rated to operate in environments from -70°F to +225°F, these rugged high quality neoprene gaskets form a tight seal between the panel face and connector flange to help keep out destructive elements. The gaskets have a thickness of .125" and meet the UL-94-HBF, Mil-R-6130C, and FMVSS-302 flammability specifications.



	
16-04978 (18 Shell Size Receptacle)	16-04477 (24 Shell Size Receptacle)





## Mounting

### Receptacle Mounting

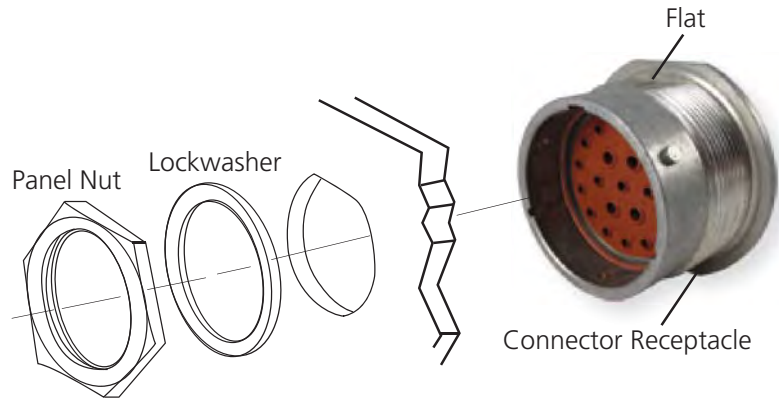
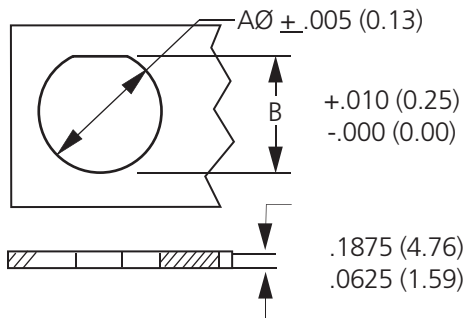

### Recommended Size of Mounting Hole

Shell Size	A $\varnothing$	B
18	1.507 (38.28)	1.442 (36.63)
24	1.696 (43.08)	1.632 (41.45)

### D Hole Punch



The D hole punch is a hand tool used to cut a D shaped hole. The D shaped hole allows the connector to be securely mounted and prevents the connector from spinning.



#### Punchable Material:

Up to .078" mild steel or aluminum. Up to .1875" plastic, wood, paneling, or other soft material.

#### Tool Material:

A2 material heat treated to a Rockwell hardness of 60 to 62.

#### Tool Size: (rough dimensions)

5.5" L x 2" H x 2" D

#### Sharpening:

The tool can be sharpened as needed.

#### Usability:

A .625" minimum pilot hole is required to accommodate the draw stud. Air tools can be used.

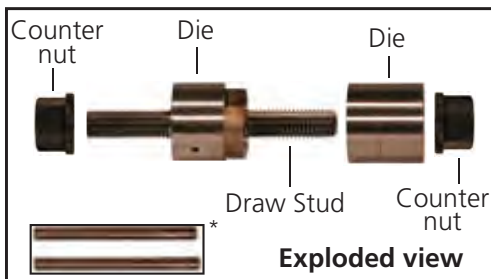

\*The rods included with the "D" hole punch are used to remove the cutout and are not used in the cutting process.

Shell Size	Part Number
18	18-D-PUNCH
24	24-D-PUNCH



## How To Instructions

### ■ Contact Insertion



**Step 1:**  
Grasp contact approximately one inch behind the contact crimp barrel.



**Step 2:**  
Hold connector with rear grommet facing you.



**Step 3:**  
Push contact straight into connector grommet until a positive stop is felt. A slight tug will confirm that it is properly locked in place.

### ■ Contact Removal

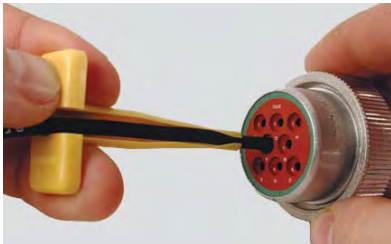

**Step 1:**  
With rear insert toward you, snap appropriate size removal tool over the wire of contact to be removed.



**Step 2:**  
Slide tool along the wire until it engages contact and resistance is felt.



**Step 3:**  
Pull contact wire assembly out of connector.

*Notice*  
Do not twist or insert tool at an angle.



*Mounting connectors horizontally allows proper water drainage.*

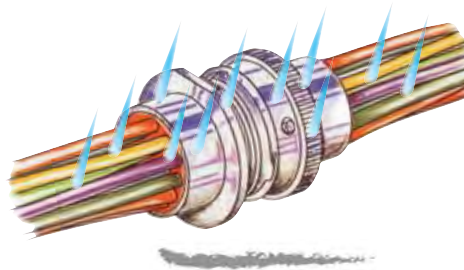



## ■ Mating Instructions

To mate the plug and the receptacle, line up the index groove on the plug with the flat surface on the receptacle, turn 1/4 turn clockwise. You will feel and hear the pieces snap into the locked position. To unmate the plug and receptacle, release the coupling ring by turning it counter-clockwise.

### *Notice*

When mating or unmating connectors, disassemble by hand. Do not use pliers or any other tool.

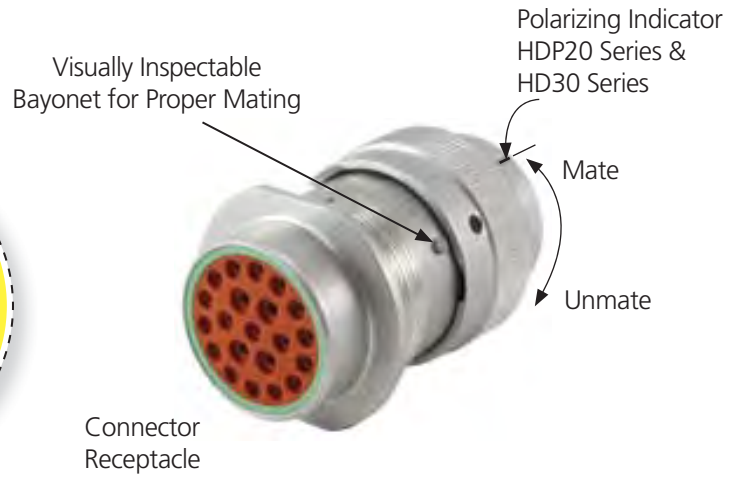



# WT Series

## Contents

WT Series Overview	92
Part Numbering System	92
Dimensions	92
Configurations	93
Accessories	93-94



## WT Series Overview

The WT connector system was engineered to address environmental issues on critical circuit applications. A black, anodized finish provides improved corrosion resistance while individual interfacial seals and redundant wire seals provide environmental protection. The composite coupling ring provides a superior mechanical coupling advantage. It can be mated and unmated easily even while wearing gloves. Available in 3, 16, or 31 cavity arrangements, the WT Series accepts size 6 AWG or size 16 AWG. As a rear accessory, the WT backshell system allows mechanical termination of convoluted tubing. The mechanical termination simplifies the assembly process and saves time.



### Part Numbering System

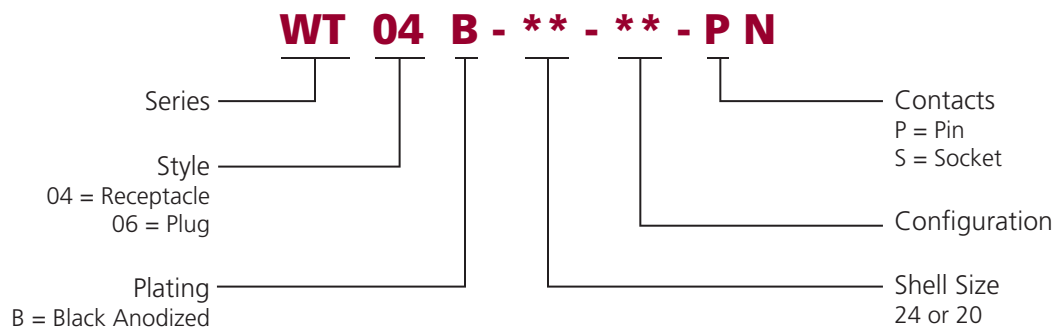

### Dimensions

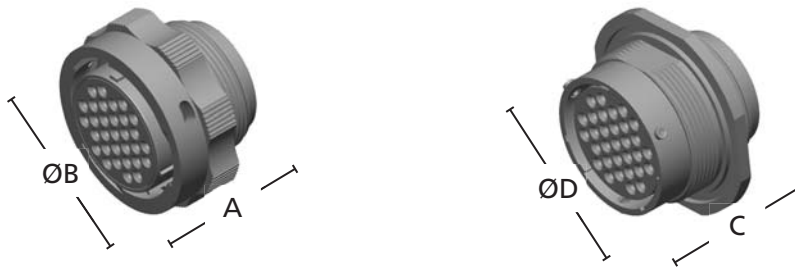

Shell Size	WT Plug		WT Receptacle	
	Overall Length A	Overall Height ØB	Overall Length C	Overall Height ØD
20	1.420 (36.07) max.	1.750 (44.45)	1.470 (37.34) max.	1.954 (49.63)
24	1.420 (36.07) max.	2.050 (52.07)	1.470 (37.34) max.	2.203 (55.96)

Dimensions are for reference only.



## ■ Configurations

Cavity identification shown from rear socket side

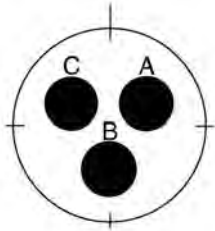

**2403 (24-03)**  
3 Size 4

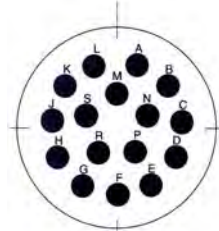

**2016 (20-16)**  
16 Size 16

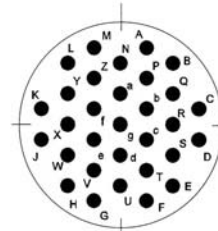

**2431 (24-31)**  
31 Size 16

## Accessories

Deutsch Industrial offers several accessory items that can be used to complement the connectors. The WT Series accessories include items such as backshells, panel nuts, o-rings, and lockwashers. Accessories are designed to complement applications and meet a wide array of design requirements such as solutions for mounting, providing additional protection, and offering increased aesthetics.

## ■ Composite Backshell System

Key to the WT Series is the unique backshell system which mechanically secures the convoluted tubing to the connector. The unique termination is accomplished by fitting the convoluted tube over the threads on a follower. The follower and tubing then attach to the connector shell with a coupling nut which permanently secures the convoluted tubing to the connector.

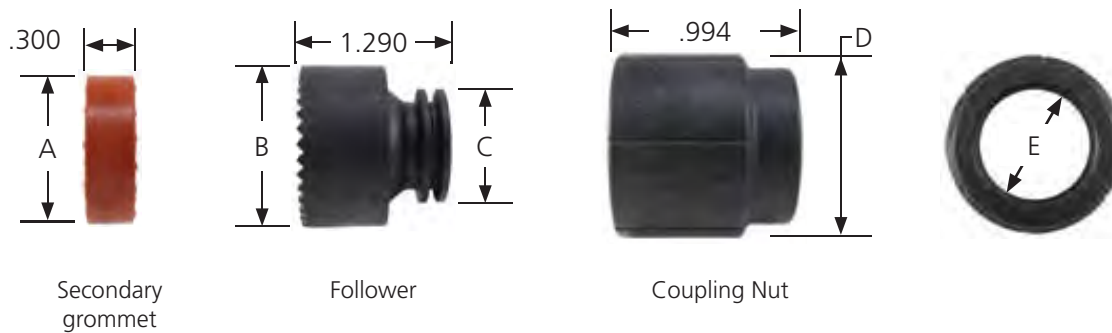

Part Number*	Shell Size	Convolute Size (ID) mm	A	B	C	D	E
88057-20-16	20	16	.984 (24.99)	1.117 (28.37)	.788 (20.02)	1.378 (35.00)	.833 (21.16)
88061-20-16	20	19	.984 (24.99)	1.117 (28.37)	.925 (23.50)	1.378 (35.00)	.980 (24.90)
88057-24-31	24	19	1.217 (30.91)	1.368 (34.75)	.925 (23.50)	1.670 (42.42)	.983 (24.97)
88061-24-31	24	22	1.217 (30.91)	1.368 (34.75)	1.110 (28.19)	1.670 (42.42)	1.184 (30.07)

Dimensions are for reference only.

\*Backshell systems are sold as a 3-piece set.

## ■ Mounting Hardware

Deutsch offers lockwashers and panel nuts to aid in mounting the WT connectors. The lockwashers are used to add tension between the threads and the nut to provide a secure mount. The lockwasher and the panel nut should be used together.

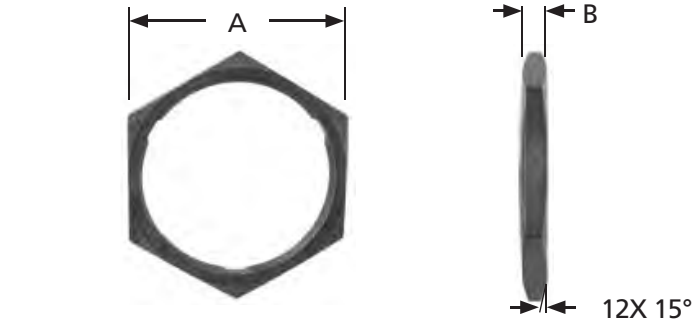

### Panel Nut

Part Number	Shell Size	A	B
0926-207-2087	20	1.562 (39.67)	.120 (3.05)
0926-207-2487	24	1.812 (46.02)	.120 (3.05)

Dimensions are for reference only.

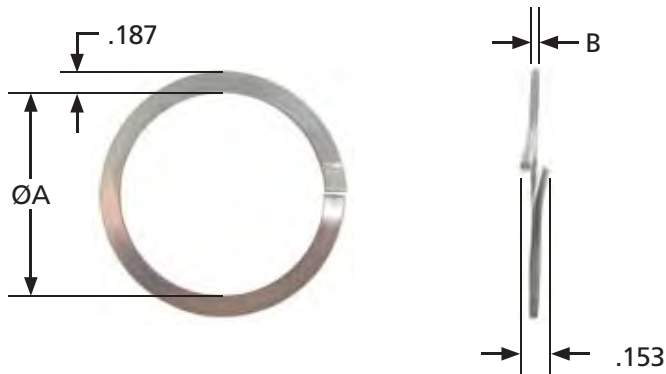

### Lockwasher

Part Number	Shell Size	ØA	B
0914-212-2086	20	1.512 (38.40)	.062 (1.57)
0914-212-2486	24	1.700 (43.18)	.062 (1.57)

Dimensions are for reference only.

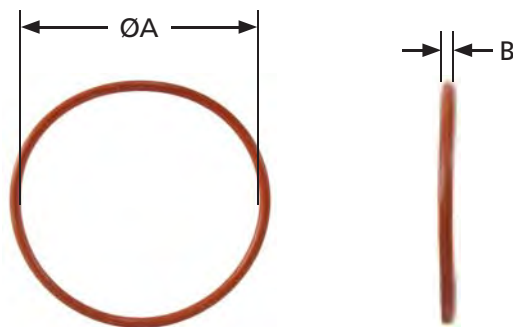

### O-Ring

Part Number	Shell Size	ØA	B
9013-3-02**	20	1.489 (37.82)	.070 (17.78)
9013-3-04-**	24	1.739 (44.17)	.070 (17.78)

Dimensions are for reference only.

\*\* = 01 for silicone

\*\* = 02 for fluorosilicone



# AEC Series

## Contents

AEC Series Overview	96
Part Numbering System	96
Dimensions	96
Configurations	97
Accessories	97





## AEC Series Overview

Deutsch's AEC Series connectors are environmentally sealed, heavy duty electrical connectors that accept size 16 contacts. The AEC Series connectors are constructed of heavy duty thermoplastic and offer receptacles with either in-line or PCB mounting options.



### Part Numbering System

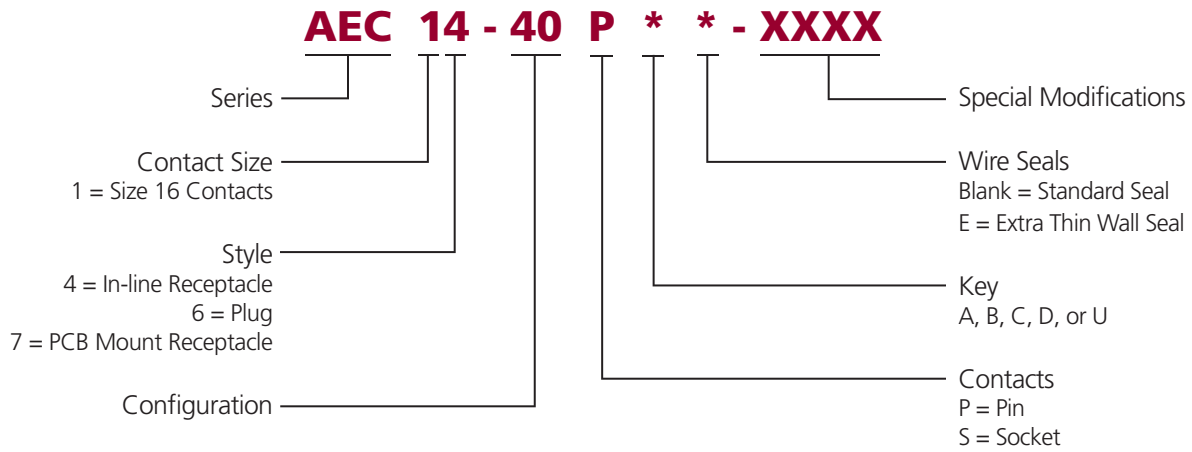

### Dimensions

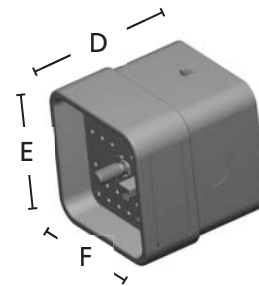
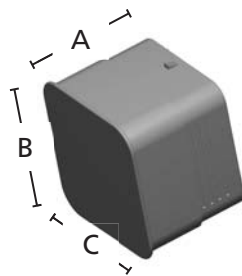

Cavity	AEC Plug			AEC Receptacle		
	Overall Length A	Overall Height B	Overall Width C	Overall Length D	Overall Height E	Overall Width F
40	1.440 (36.58)	1.778 (45.16)	1.894 (48.11)	1.642 (41.71)	1.944 (49.38)	1.828 (46.43)

Dimensions are for reference only.

**Configuration**

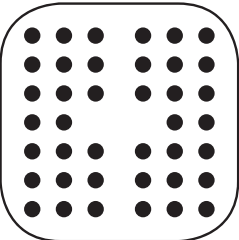
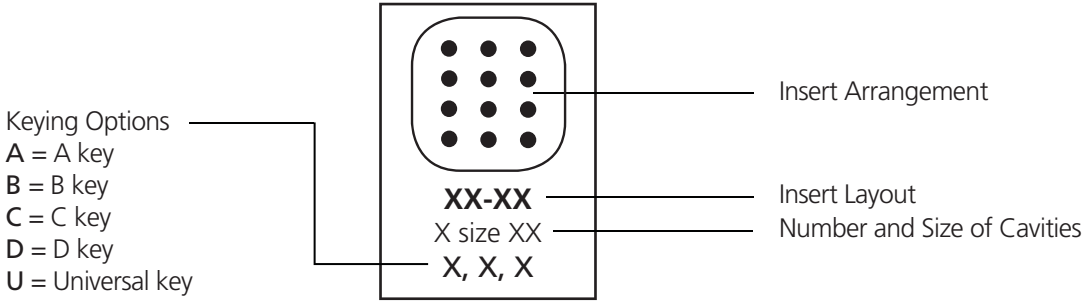

**AEC1\*-40\*\*\***  
 40 size 16  
 A, B, C, D, U

**Notice**

Do not over torque jackscrew. The recommended torque rating for the AEC Series plug jackscrew when tightening is 25-28 IN-LB.

**Accessories**

Deutsch Industrial offers dust caps for use with the AEC Series. The dust caps are available in both environmentally sealed and non-environmentally sealed options. The dust caps are designed to provide protection to the connector interface when the connector halves are not mated.



**Dust Cap**

Part Number	Description
0504-002-4001	Dust cap, 40 way receptacle, environmentally sealed
0515-009-4005	Dust cap, 40 way receptacle, non-environmentally sealed
0515-010-4005	Dust cap, 40 way plug, non-environmentally sealed





# STRIKE Series

## Contents

STRIKE Series Overview 100

---

Part Numbering System 100

---

Dimensions 100

---

Configurations 101

---

Required Components 102

---

Accessories 103

---

Tools & Contacts 103-105

---

How To Instructions 106

---



## STRIKE Series Overview

The STRIKE connector series features a lever lock system and is designed for heavy duty equipment applications. The environmentally sealed series offers three different size rugged housings that accept contacts from size 20 to Ø12mm with arrangements from 1 to 64 cavities. The lever lock combined with varying cavity arrangements allows the STRIKE Series to offer flexible options for electrical designs.



### Part Numbering System

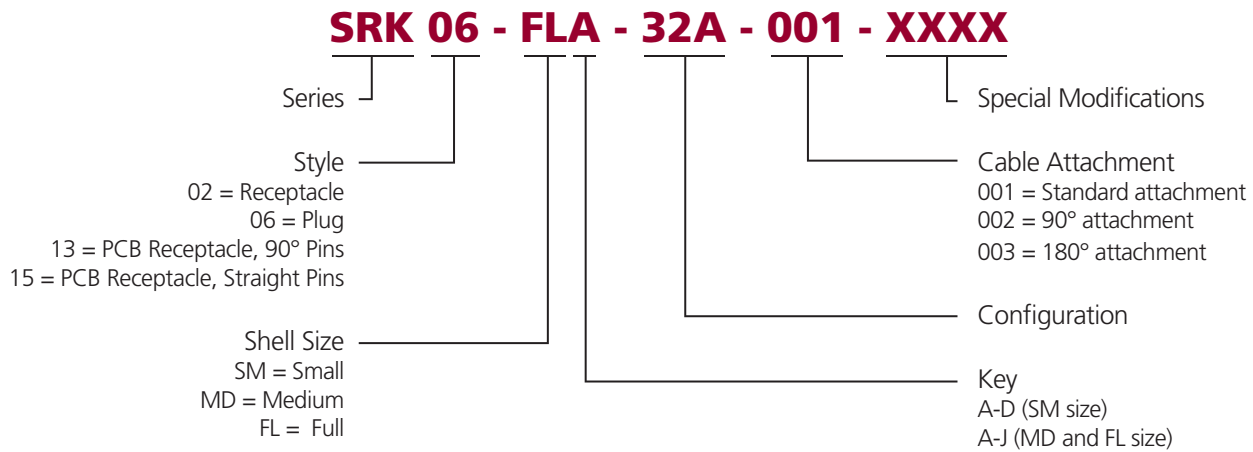

### Dimensions

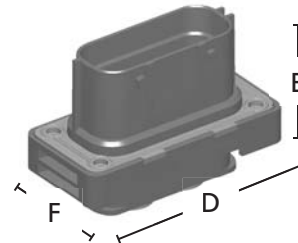
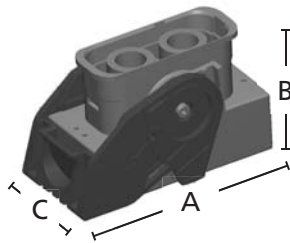

Shell Size	STRIKE Plug			STRIKE Receptacle		
	Overall Length A	Overall Height B	Overall Width C	Overall Length D	Overall Height E	Overall Width F
SM	1.879 (47.74)	2.256 (57.30)	1.902 (48.30)	2.028 (51.50)	2.768 (70.30)	1.811 (46.00)
MD	3.189 (81.00)	1.909 (48.50)	1.531 (38.90)	3.228 (82.00)	2.205 (56.00)	1.575 (40.00)
FL	3.358 (85.28)	1.913 (48.60)	2.780 (70.60)	3.228 (82.00)	2.205 (56.00)	2.953 (75.00)

Dimensions are for reference only.

■ Small (SM) Configurations

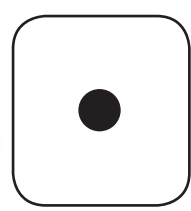

**SM\*-01A**  
1 - SRK Ø8mm

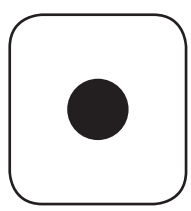

**SM\*-01B**  
1 - SRK Ø12mm

*Notice*

Consult your Deutsch representative for customized module opportunities.

■ Medium (MD) Configurations

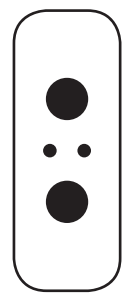

**MD\*-04A**  
2 - SRK Ø8mm  
2 - Size 16

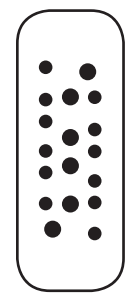

**MD\*-18A**  
6 - Size 12  
12 - Size 16

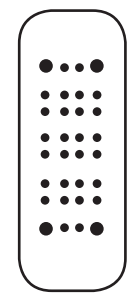

**MD\*-32A**  
4 - Size 16  
28 - Size 20

■ PCB Configurations

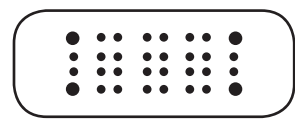

**MD\*-32A**  
4 - Size 16  
28 - Size 20

■ Full (FL) Configurations

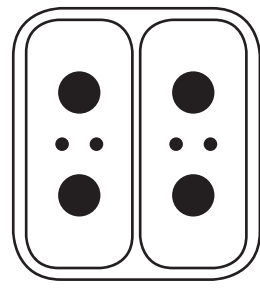

**FL\*-08A**  
4 - SRK Ø8mm  
4 - Size 16

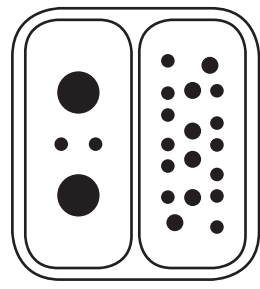

**FL\*-22A**  
2 - SRK Ø8mm  
6 - Size 12  
14 - Size 16

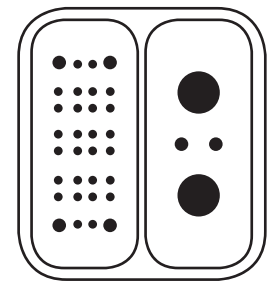

**FL\*-36A**  
2 - SRK Ø8mm  
6 - Size 16  
28 - Size 20

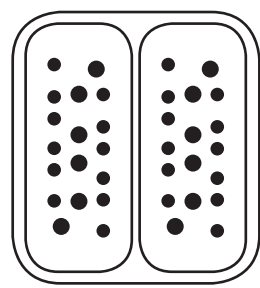

**FL\*-36B**  
12 - Size 12  
24 - Size 16

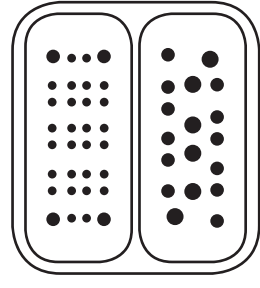

**FL\*-50A**  
6 - Size 12  
16 - Size 16  
28 - Size 20

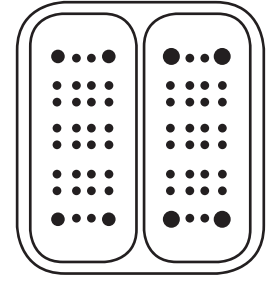

**FL\*-64A**  
8 - Size 16  
56 - Size 20

## Required Components

### ■ Cable Attachments

Cable attachments assist in high vibration applications by providing a location for securing wire bundles with a tie wrap. The use of a 5mm tie wrap is recommended. STRIKE connector arrangements include either a standard cable attachment (-001), a 90° attachment (-002), or a 180° attachment (-003) specified in the part number suffix.



standard attachment



90° attachment



180° attachment





### ■ Cavity Plug

Silicone cavity plugs are used to fill an unused cavity in a connector without an integrated rear seal. Filling the unused cavity maintains the integrity of the environmental seal. The -04A cavity arrangement requires a cavity plug if the size 16 cavities are unused.

Cavity Plug	Contact Size	Part Number	Material
	16	25JH0024	silicone

### ■ Wire Seal Grommets

Wire seal grommets are required on connectors without integrated rear seals in order to maintain an environmental seal. The size 16 wire seals are required for an environmental seal on any connector using the -04A cavity insert. The wire seals for Ø8mm and Ø12mm contacts are placed on the wire prior to crimping the contact, and then slid into place once the contact is inserted into the connector.

Grommet	Contact Size	Part Number	Insulation Range (mm)	Color
	16	25JH0040	.079-.118 (2.00-3.00)	Yellow
		25JH0042	.047-.079 (1.20-2.00)	Green
	Ø8mm	SRK-WS-25-001	.283-.394 (7.20-10.00)	Red
		SRK-WS-35-001	.394-.472 (10.00-12.00)	Blue
	Ø12mm	SRK-WS-70-001	.413-.630 (10.50-16.00)	Red
		SRK-WS-90-001	.630-.787 (16.00-20.00)	Blue





## Accessories

Deutsch Industrial offers backshells that can be used to complement the connectors. The backshells provide additional protection and offer increased aesthetics.

### ■ Backshells

The Deutsch STRIKE Series backshells are designed to snap onto the connectors and accept 17mm, 22mm, and 26mm convoluted tubing. The backshells assist with wire routing to ease engagement and disengagement of the lever lock.

Backshell	Part Number	Size	Direction	Convoluted Tubing	Description
	SRK-BS-SM-ST-001	Small	Straight	N/A	Straight plastic backshell for small size plugs and receptacles, max insulation is Ø.472 (12.00)
	SRK-BS-SM-ST-002				Straight plastic backshell for small size plugs and receptacles, max insulation is Ø.591 (15.00)
	SRK-BS-SM-ST-003				Straight plastic backshell for small size plugs and receptacles, max insulation is Ø.827 (21.00)
	SRK-BS-MD-90-001 SRK-BS-MD-90-002	Medium	90°	NW17 & 22(-001) NW22(-002)	90° plastic backshell for medium or full size plugs and receptacles
	SRK-BS-FL-90-001 SRK-BS-FL-90-002	Full		NW22 & 26(-001) NW26(-002)	
	SRK-BS-MD-ST-001 SRK-BS-MD-ST-002	Medium	Straight	NW17(-001) NW22(-002)	Straight plastic backshell for medium or full size plugs and receptacles
	SRK-BS-FL-ST-001 SRK-BS-FL-ST-002	Full		NW22(-001) NW26(-002)	

## Tools & Contacts

Deutsch Industrial offers several easy to use crimp tools for crimping both solid and stamped & formed contacts. Other tools are also available for the assembly and removal of contacts and secondary locking specific to the STRIKE Series.

### ■ Crimp Tools for STRIKE Series



Contact Size	Contact Style	Hand Crimp Tool	Production Crimp Tool
Ø8mm, Ø12mm	Solid	Hex shaped crimp per NFC20.130 standard*	
12-20	Solid	HDT-48-00	HDP-400
12	Stamped & Formed	DTT-12-00, DTT-12-01	DCT12-02-00, DCT12-02-01
16	Stamped & Formed	DTT-16-00, DTT-16-01, DTT-16-02	DCT1620-02-00
20	Stamped & Formed	DTT-20-00, DTT-20-02	DCT1620-02-00

\*See drawing 8925-003-0000 for full specifications.

## ■ Assembly/Removal Tools for STRIKE Series







### Contact Removal Tools

The STRIKE Series Ø8mm and Ø12mm contacts require the following removal tools.

Tool	Part Number	Connector	Description
	SRK-EXT-80	Plug and Receptacle	Removal tool for Ø8mm contacts
	SRK-EXT-120	Plug and Receptacle	Removal tool for Ø12mm contacts

### TPA Tools

The STRIKE Series has integrated TPA, which require removal tools. Multiple STRIKE tools may be needed to service a single connector. TPA removal tools are specific to each connector half and some cavity arrangements.

Tool	Part Number	Connector	Description
	SRK-RT-02	Receptacle	TPA removal tool for receptacles Not for use with 18 cavity insert
	SRK-RT-02-G2	Receptacle	TPA removal tool for receptacles For use with 18 cavity insert
	SRK-RT-06	Plug	TPA removal tool for plugs Not for use with 18 cavity insert
	SRK-RT-06-G2	Plug	TPA removal tool for plugs For use with 18 cavity insert
	SRK-MT-02	Receptacle	TPA mounting tool for receptacles
	DT-RT1	Plug and Receptacle	Field service removal tool (TPA or contacts) for plugs and receptacles

### Notice

The TPA removal tool for the 18 cavity insert cannot be used on any other insert.

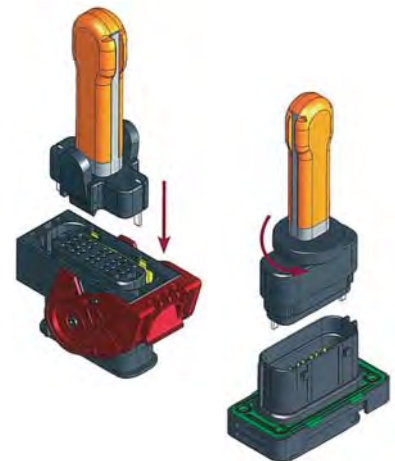

■ Solid Contacts for STRIKE Series

Size	Solid Contact Part Numbers		Wire Size AWG (mm <sup>2</sup> )	Recommended Strip Length Inches (mm)	Min. Contact Retention	Ref Crimp Tensile Lbs. (N)	Max Rated Amps at 125° Continuous
	Pin	Socket					
20	0460-202-20**	0462-201-20**	20 (0.50)	.156-.218 (3.96-5.54)	20 (89)	20 (89)	7.5
20	0460-010-20**	0462-005-20**	16-18 (1.0-0.75)	.156-.218 (3.96-5.54)	20 (89)	20 (89)	7.5
16	0460-202-16**	0462-201-16**	16-20 (1.5-0.50)	.250-.312 (6.35-7.92)	25 (111)	35-20 (156-89)	13
16	0460-215-16**	0462-209-16**	14 (2.0)	.250-.312 (6.35-7.92)	25 (111)	70 (311)	13
12	0460-204-12**	0462-203-12**	12-14 (3.0-2.0)	.222-.284 (5.64-7.21)	30 (134)	75-70 (334-311)	25
Ø8mm	SRK-PC-080-16-601	SRK-SC-080-16-601	6 (16)	.530-.580 (13.47-14.74)	56 (250)	367 (632)	---
Ø8mm	SRK-PC-080-20-601	SRK-SC-080-20-601	5	.530-.580 (13.47-14.74)	56 (250)	416 (1850)	---
Ø8mm	SRK-PC-080-25-601	SRK-SC-080-25-601	4 (25)	.530-.580 (13.47-14.74)	56 (250)	489 (2175)	---
Ø8mm	SRK-PC-080-32-601	SRK-SC-080-32-601	2	.530-.580 (13.47-14.74)	56 (250)	562 (2500)	---
Ø8mm	SRK-PC-080-35-601	SRK-SC-080-35-601	(35)	.530-.580 (13.47-14.74)	56 (250)	598 (2660)	150
Ø12mm	SRK-PC-120-40-601	SRK-SC-120-40-601	1 (40)	.837-.887 (21.27-22.54)	56 (250)	639 (2840)	---
Ø12mm	SRK-PC-120-50-601	SRK-SC-120-50-601	1/0 (50)	.837-.887 (21.27-22.54)	56 (250)	720 (3200)	---
Ø12mm	SRK-PC-120-70-601	SRK-SC-120-70-601	2/0 (70)	.837-.887 (21.27-22.54)	56 (250)	819 (3640)	---
Ø12mm	SRK-PC-120-95-601	SRK-SC-120-95-601	3/0 (95)	.837-.887 (21.27-22.54)	56 (250)	898 (3990)	300

Deutsch has tested Ø8mm contacts using 35mm<sup>2</sup> wire at 150 amps at 125°C continuous, and Ø12mm contacts using 95mm<sup>2</sup> wire at 300 amps at 125°C continuous. Therefore, these contacts are rated at full current at 125°C using the max wire gauge cable only. The amperage capacities for the remaining Ø8mm and Ø12mm contact options using smaller gauge cable will need to be tested based on individual applications.

Amperage ratings are based on single circuits. The test data does not take into account multiple contacts, mixed wire gauges, and other variables that may be present in an actual application.

**Solid Contact Plating Codes**

Part Number Suffix (**)	Material
31	Gold
141	Nickel
601	Silver



## How To Instructions

### ■ Contact Insertion



**Step 1:**  
Ensure TPA locking is open.



**Step 2:**  
Hold connector with rear seal retainer facing you.



**Step 3:**  
Push contact straight into the grommet until a positive stop is felt. A slight tug will confirm that it is properly locked in place.



**Step 4:**  
Push to close the TPA. TPA will not close unless all contacts are fully seated in connector.

### ■ Removal of Deutsch Common Contacts



**Step 1:**  
Use DT-RT1 to open the TPA with light turn against the locking clip.



**Step 2:**  
Repeat step 1 on the other side of the TPA.



**Step 3:**  
Remove the TPA.



**Step 4:**  
Unlock the contacts and pull on the wire.

### ■ Removal of Deutsch Ø8mm and Ø12mm Contacts



**Step 1:**  
After TPA is removed, insert the SRK removal tool over the contact.



**Step 2:**  
Push the tool to open the contact retention fingers.



**Step 3:**  
Pull the wire to remove the contact.



# Quick Connect Series



## Contents

Quick Connect Series Overview	108
Part Numbering System	108
Dimensions	108
Configurations	109
Accessories	109-111
Tools & Contacts	111-112





## Quick Connect Series Overview

The Quick Connect Series are environmentally sealed compact connectors that feature three contact arrangements with wire gauge from 16 to 26 AWG. The small size and high pin density of the Quick Connect Series is flexible for many engineering design requirements. Additional flexibility is achieved through a wide range of universal mounting options to match the demands of harsh environments.



### Part Numbering System

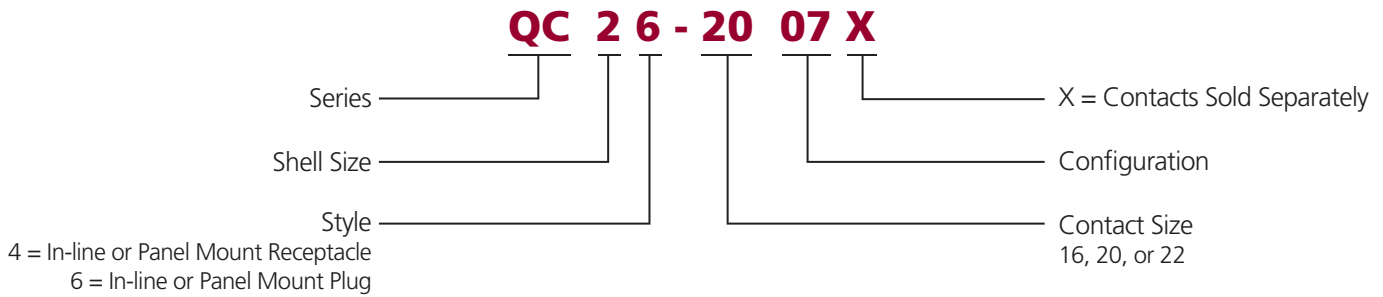

### Dimensions



Cavity	QC Plug		QC Receptacle	
	Overall Length A	Overall Width B	Overall Length C	Overall Height D
2	.988 (25.10)	.756 (19.20) max.	1.319 (33.50) max.	.906 (23.00) max.
7	1.004 (25.50)			
12	.984 (25.00)			

Dimensions are for reference only.

**Configurations**

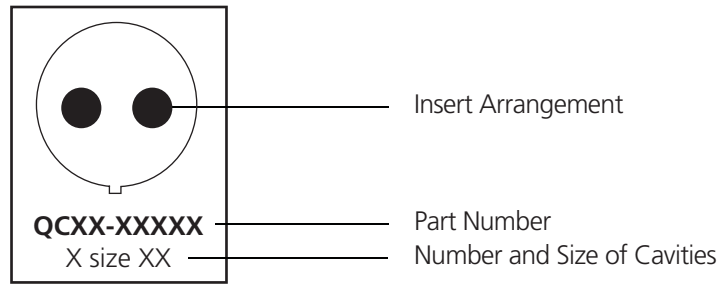

Plugs - cavity identification from rear

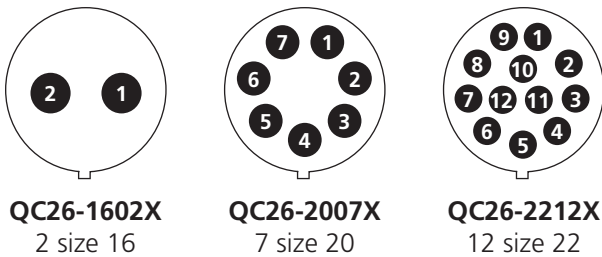

Receptacles - cavity identification from rear

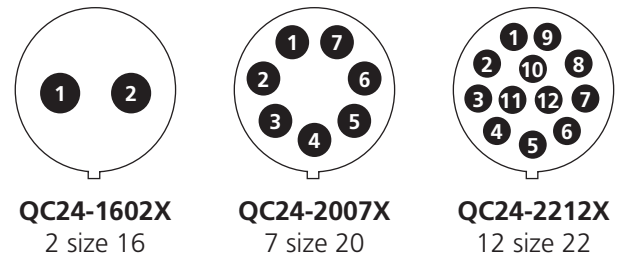



**Accessories**

Deutsch Industrial offers several accessory items that can be used to complement the connectors. The Quick Connect Series accessories include items such as back fittings, wire seals, compression screws, and mounting hardware. Accessories are designed to complement applications and meet a wide array of design requirements such as mounting solutions, providing additional protection, and offering increased aesthetics.

**Dust Caps**

Deutsch offers dust caps for use with the Quick Connect Series of connectors. Dust caps are available to maintain the environmental seal for both the plug and receptacle. The QC dust caps include a lanyard for easy use.

Dust Cap	Part Number	Description
	QC28	Pro-cap low cost (plug only)
	QC38	Plug pro-cap with lanyard
	QC39	Receptacle pro-cap with lanyard





## ■ Back Fittings

Name	Description	Part Number
1. Washer	Neoprene washer that provides an environmental seal between connector and mounting surface or long compression rear adapter.	429638
2. Panel mount lock nut	Lock nut for attaching connector to mounting surface or to deck mount flange.	429637
3. Deck mount flange	Flange used to mount the connector. Connector attaches to deck mount flange and deck mount flange attaches to mounting surface.	429726
4. Deck mount gasket	Neoprene gasket used with the deck mount flange to provide an environmental seal between the flange and mounting surface.	429727
5. Long compression rear adapter	Adapter used to join the compression screw or compression screw with strain relief to the connector.	429624
6. Seal ring	Nitrile ring with removable segments to adapt to multiple jacketed cable diameters. The seal ring is placed in the back of the long compression rear adapter. The compression screw or compression screw with strain relief tightens down against the seal ring to form an environmental seal on the jacketed cable.	429707
7. Compression screw	Screws onto the back of the long compression rear adapter and tightens down against the seal ring to form a seal on the jacketed cable.	429662
8. Compression screw with strain relief	Screws onto the back of the long compression rear adapter and tightens down against the seal ring to form a seal on the jacketed cable. Has two screws that are tightened down to provide strain relief.	429706
9. Wire seal, 2 way	Silicone grommet with 2, 7, or 12 cavities that is inserted into the back of the connector. An environmental seal is achieved on the individual wires.	429621-02
Wire seal, 7 way		429621-07
Wire seal, 12 way		429621-12





## ■ Panel Mount Examples

The Quick Connect Series offers several mounting options, below are a few examples. Refer to the back fittings section to see a complete list of all of the options.

Description	Components
Provides seal against insulation on individual wires, and between connector and mounting surface.	
Provides seal against mounting surface and deck mount flange, and between deck mount flange and connector.	

**Wire Seal Examples**

The Quick Connect Series offers several sealing options to accommodate many design requirements. The QC connectors can be used unsealed, or with additional items can be sealed up to an IP68 watertight seal. Below are a few examples of possible sealing options. Refer to the back fittings section to see a complete list of all of the options.

Description	Components
Provides seal against insulation on individual wires.	
Provides seal between connector and adapter, and against jacketed cable.	
Provides seal against insulation on individual wires, between connector and adapter, and against jacketed cable. Includes strain relief.	

**Notice**  
 Diameter .18-.43 (4.5-11.0) cable sealing, compression fittings must be correctly tightened to achieve IP68 watertight seal.

**Tools & Contacts**

The Quick Connect Series uses special contacts and tools. The contacts are smaller and designed for high pin density. Removal tools along with multiple crimp tools are available and are designed to work with the smaller contacts and tighter pin arrangements. The Common Contact System and tools are not compatible with the Quick Connect Series.

**Tools for Quick Connect Series**

Tools for Solid Contacts	
<b>Part Number</b>	<b>Adjustable Hand Crimp Tools</b>
MH860	QC/IMC #22 crimp tool, adjustable AWG ranges, requires 86-5
86-5	QC/IMC crimp tool positioner for MH860
AF8-TH163	QC/IMC #20 and #16 crimp tool, adjustable AWG ranges
	<b>Single Gauge Hand Crimp Tools</b>
AMSC22/1	QC/IMC #22 crimp tool, low cost, only crimps 22 AWG wire
AMSC20/1	QC/IMC #20 crimp tool, low cost, only crimps 20 AWG wire
AMSC16/A/1	QC/IMC #16 crimp tool, low cost, only crimps 16 AWG wire
	<b>Insert/Removal Tools</b>
6757-201-2201	Insert/Removal Tool #22
6757-201-2001	Insert/Removal Tool #20
6757-201-1601	Insert/Removal Tool #16





## ■ Solid Contacts for Quick Connect Series



Size	Solid Contact Part Numbers		Wire Size AWG	Recommended Strip Length Inches (mm)	Sealing Range Diameter Inches (mm)
	Pin	Socket			
22	6860-201-22278	6862-201-22278	22, 24, 26	.160-.190 (4.06-4.83)	.030-.054 (.76-1.37)
20	6860-201-20278	6862-201-20278	20, 22, 24	.230-.260 (5.84-6.60)	.040-.083 (1.02-2.11)
16	6860-201-16278	6862-201-16278	16, 18, 20	.230-.260 (5.84-6.60)	.065-.109 (1.65-2.77)



# IMC Series

## Contents

IMC Series Overview	114
Part Numbering System	114
Dimensions	114
Configurations	115
Accessories	116
Tools & Contacts	117

## IMC Series Overview

The Industrial Micro Connector Series are unsealed connectors constructed from Ultem®, a high temperature and corrosion resistant composite material suited for industrial applications. The IMC Series offers high pin density and several contact arrangements that accept a wide range of wire gauges. They feature a bayonet style lock coupling mechanism and withstand heat, dust, and moisture. To create an environmental seal and achieve an IP67 rating, the addition of a back fitting and adhesive is required.

The compact design is ideal for applications where space is at a premium, meeting the requirements of manufacturers of test equipment, industrial sensors, medical diagnostic equipment, instrumentations and process control systems.



### Part Numbering System

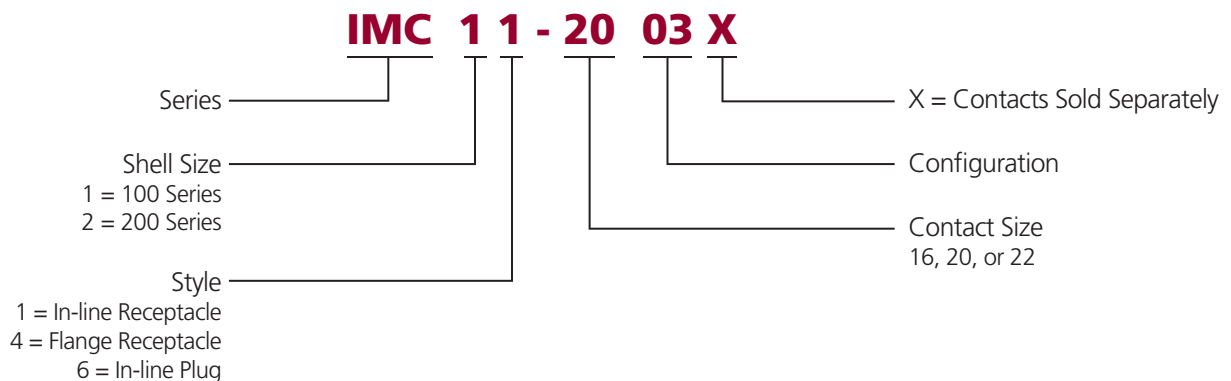

### Dimensions

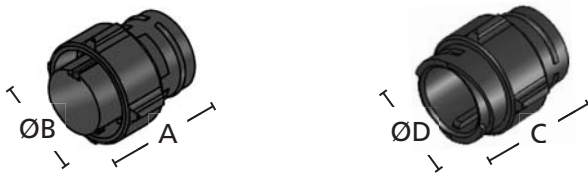

Series	Style	IMC Plug		IMC Receptacle	
		Overall Length A	Overall Width ØB	Overall Length C	Overall Width ØD
100	In-line	.030 (.755) max.	.024 (.600) max.	.030 (.755) max.	.024 (.599) max.
	Flange	--	--	.030 (.755) max.	.028 (.705) max.
200	In-line	.030 (.755) max.	.030 (.755) max.	.030 (.755) max.	.030 (.755) max.
	Flange	--	--	.030 (.755) max.	.037 (.945) max.

Dimensions are for reference only.

**Configurations**

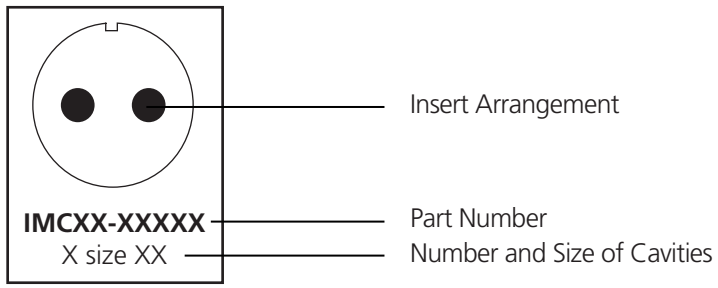

Plugs - cavity identification from rear

**100 Series**

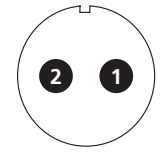

**IMC16-2002X**  
2 size 20

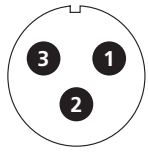

**IMC16-2003X**  
3 size 20

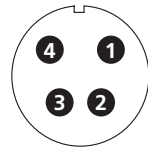

**IMC16-2204X**  
4 size 22

**200 Series**

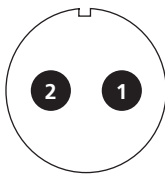

**IMC26-1602X**  
2 size 16

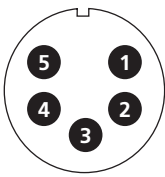

**IMC26-2005X**  
5 size 20

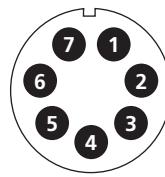

**IMC26-2007X**  
7 size 20

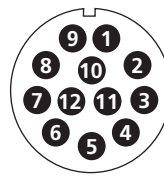

**IMC26-2212X**  
12 size 22

Receptacles - cavity identification from rear

**100 Series**

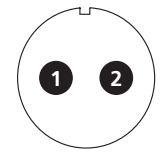

**IMC1\*-2002X**  
2 size 20

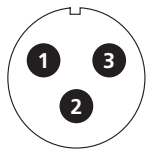

**IMC1\*-2003X**  
3 size 20

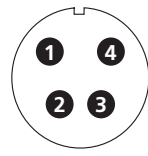

**IMC1\*-2204X**  
4 size 22

**200 Series**

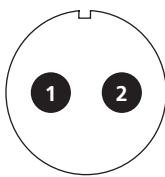

**IMC2\*-1602X**  
2 size 16

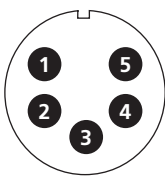

**IMC2\*-2005X**  
5 size 20

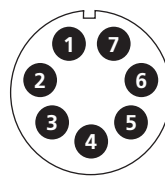

**IMC2\*-2007X**  
7 size 20

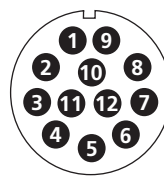

**IMC2\*-2212X**  
12 size 22

## Accessories

Deutsch Industrial offers several accessory items that are used to complement the connectors. The IMC family accessories include items such as boots, dust caps, and adapters. Accessories are designed to complete the application and meet a wide array of design requirements such as providing additional protection and offering increased aesthetics.

### Boots

Boots provide a professional looking finishing touch for your Deutsch IMC Series connectors. Santoprene boots are used to provide additional protection and provide strain relief. The boots can be used with an epoxy adhesive to seal the connectors against dust and moisture and achieve an IP67 rating.

#### Notice

To achieve an IP67 rating, Raychem S1125 type 2-part epoxy must be used.



#### Boot

Part Number	Description
6810-207-1001-2-200	100 Series .200 in. (5.08) opening
6810-207-2001-2-105	200 Series .105 in. (2.67) opening
6810-207-2001-2-125	200 Series .125 in. (3.17) opening
6810-207-2001-2-120	200 Series .120 in. (3.05) opening
6810-207-2001-2-140	200 Series .140 in. (3.56) opening
6810-207-2001-2-250	200 Series .250 in. (6.35) opening
6810-207-2001-2-165	200 Series .165 in. (4.19) opening

### Dust Caps

IMC connectors plastic dust caps are available to provide a temporary cover for the connector interface when the connectors are not mated.



#### Dust Cap

Part Number	Description
IMC18	100 Series pro-cap plug
IMC19	100 Series pro-cap receptacle
IMC28	200 Series pro-cap plug
IMC29	200 Series pro-cap receptacle

### Adapters

The IMC Series adapters are used to provide added protection and strain relief. The adapters are made up of several parts and feature a housing that is tightened with screws to provide the appropriate grip on the wires.



#### Adapter

Part Number	Description
IMC1AD	100 Series adapter
IMC2AD	200 Series adapter



## Tools & Contacts

The Industrial Micro Connect Series uses special contacts and tools. The contacts are smaller and designed for high pin density. Removal tools along with multiple crimp tools are available and are designed to work with the smaller contacts and tighter pin arrangements. The Common Contact System and tools are not compatible with the IMC Series.

### ■ Tools for IMC Series

Tools for Solid Contacts	
<b>Part Number</b>	<b>Adjustable Hand Crimp Tools</b>
MH860	QC/IMC #22 crimp tool, adjustable AWG ranges, requires 86-5
86-5	QC/IMC crimp tool positioner for MH860
AF8-TH163	QC/IMC #20 and #16 crimp tool, adjustable AWG ranges
	<b>Single Gauge Hand Crimp Tools</b>
AMSC22/1	QC/IMC #22 crimp tool, low cost, only crimps 22 AWG wire
AMSC20/1	QC/IMC #20 crimp tool, low cost, only crimps 20 AWG wire
AMSC16/A/1	QC/IMC #16 crimp tool, low cost, only crimps 16 AWG wire
	<b>Insert/Removal Tools</b>
6757-201-2201	Insert/Removal Tool #22
6757-201-2001	Insert/Removal Tool #20
6757-201-1601	Insert/Removal Tool #16



### ■ Solid Contacts for IMC Series



Size	Solid Contact Part Numbers		Wire Size AWG	Recommended Strip Length Inches (mm)
	Pin	Socket		
22	6860-201-22278	6862-201-22278	22, 24, 26	.160-.190 (4.06-4.83)
20	6860-201-20278	6862-201-20278	20, 22, 24	.230-.260 (5.84-6.60)
16	6860-201-16278	6862-201-16278	16, 18, 20	.230-.260 (5.84-6.60)



Size	PCB Pin Part Number
22	6860-202-22278
20	6860-202-20278
16	6860-202-16278





# Common Contacts

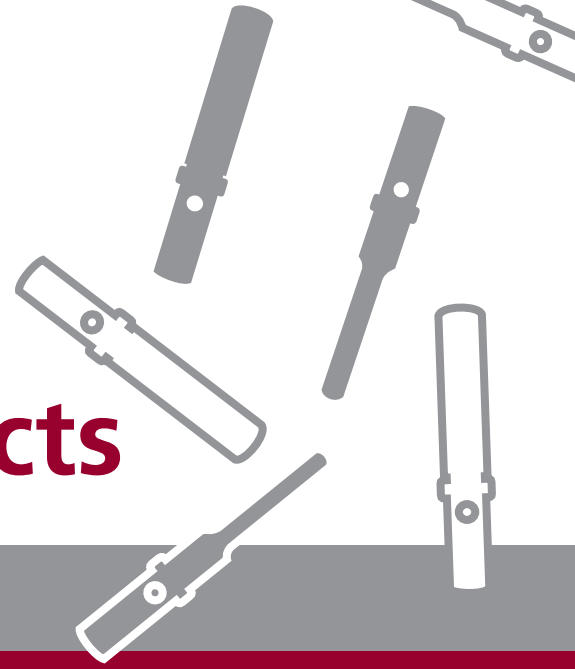

## Contents

Common Contact System Overview	120
Features & Benefits	121
Performance Specifications	122
Wire Sealing Ranges	123-124
Solid Contacts	125-126
Stamped & Formed Contacts	127
PCB Pins	128

Crimping	129
Crimp Inspection	130
Accessories	131-132
How To Instructions	132-133

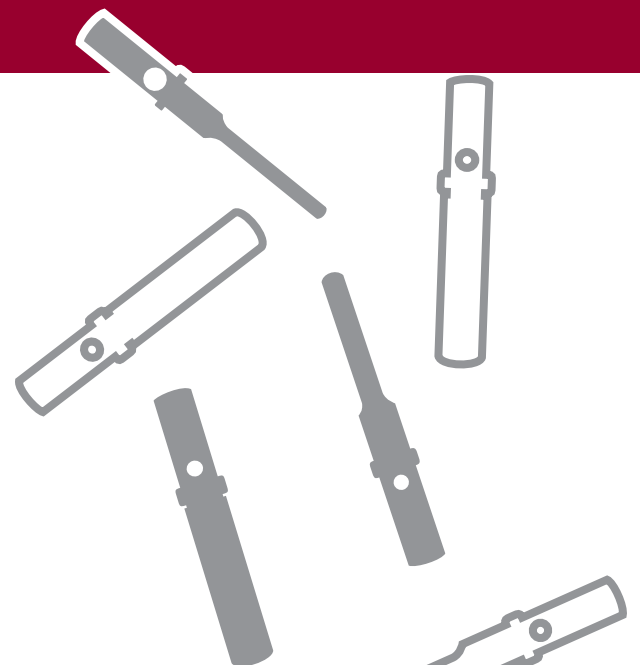



## Common Contact System Overview

The word “common” is used to describe the Deutsch contact system because the contacts are used interchangeably in many Deutsch Industrial connectors and across most connector series. The common contact system improves performance, reliability, and maintainability by reducing changes in the assembly of the wire harness. The use of a common contact system eliminates many of the failures reported in harnesses where hundreds of different terminations are used.

### ■ Contacts

Deutsch offers two styles of contacts, stamped & formed and solid. Both contact types use a crimp style termination, eliminating the need for solder. All Deutsch Industrial terminals protect the split socket tines. The only variations in the Deutsch Common Contact System are those dictated by wire gauge and contact style.

#### **Solid**

The solid contacts are designed for use with larger wire size and heavy duty applications. Solid contacts are manufactured using a cold heading process with solid copper alloy wire and are available with either a nickel or gold plating finish.

Solid contacts terminate wire from 3/0 AWG to 20 AWG (95 - 0.5mm<sup>2</sup>) and are available in 7 sizes each of the pin and socket. The applicable contact is determined by the size of the conductor only. The solid style contacts are sold in bulk.

### ■ Design Materials and Selection

Deutsch engineers combined superior material selection with mechanical CAD/CAM designs to create stamped & formed contacts that exceed the demands of today's industrial electrical systems.

To provide exceptional durability, performance, corrosion, and oxidation resistance, contacts are made from copper alloys, finished with nickel, tin, or gold plating. To guarantee resistance to crimp relaxation and displacement of metal, the contacts are designed with the conductor wings formed in the direction of the crimp to achieve gas tight crimps that eliminate the need for solder. All Deutsch socket tines are protected to provide controlled contact pressure for maximum conductivity with minimum surface wear.

#### **Stamped & Formed**

Deutsch stamped & formed contacts are designed for use where wire termination costs are of primary concern without sacrificing reliability of electrical circuits. The stamped & formed contacts are made on a precision stamping machine using flat strip stock, then a durable and corrosion proof nickel, tin, or optional gold plating is applied.

The stamped & formed style contacts terminate wire from 10 AWG to 22 AWG (6.0 - 0.35mm<sup>2</sup>) and are available in multiple sizes to accommodate a wide range of wire insulation. The specific contact is determined by the outside diameter of wire insulation and conductor size. The stamped & formed contacts are sold on reels.



In keeping with the Deutsch commitment to total quality, all stamped & formed contacts are manufactured using statistical process controls and are subjected to extensive rigorous testing programs, in the lab and in actual field performance.



## ■ Solid Contact Features

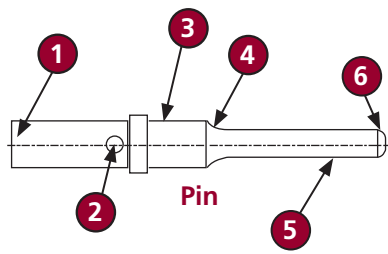

- 1 Wire lead-in chamfer to aid wire insertion
- 2 Inspection hole
- 3 Maximum diameter to prevent bending
- 4 Radius for added strength
- 5 Smooth finish to minimize mating forces
- 6 Radius for smooth engagement and prevent misalignment

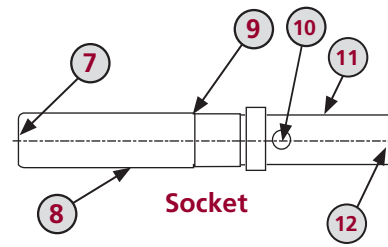

- 7 Closed entry to prevent probe damage and prevent misalignment, chamfered lead-in to prevent misalignment
- 8 Durable tines for superior electrical performance
- 9 Stainless steel sleeve for maximum socket tine protection (except sleeveless sockets)
- 10 Inspection hole
- 11 Crimp barrel
- 12 Wire lead-in chamfer to aid wire insertion

## ■ Stamped & Formed Contact Features

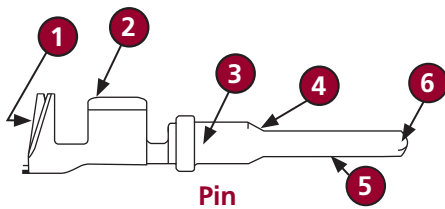

- 1 Insulation wings for additional wire support
- 2 Conductor wings for minimal contact resistance
- 3 Maximum diameter to prevent bending
- 4 Chamfered for added strength
- 5 Smooth finish to minimize mating forces
- 6 Radius for smooth engagement and prevent misalignment

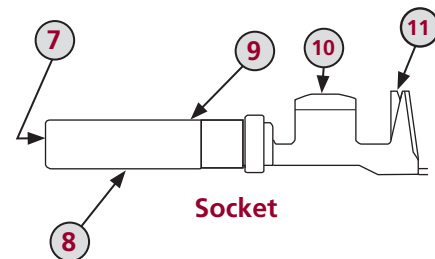

- 7 Closed entry to prevent probe damage and prevent misalignment, chamfered lead-in to prevent misalignment
- 8 Durable tines for superior electrical performance
- 9 Stainless steel sleeve for maximum socket tine protection (except sleeveless sockets)
- 10 Conductor wings for minimal contact resistance
- 11 Insulation wings for additional wire support

## ■ Benefits of Deutsch Contacts

- Solid shoulder for high tensile strength pin retention.
- Nickel plating standard for corrosion resistance.
- Solder is not recommended, eliminating flux corrosion.
- No retention tangs required, eliminating contact damage.



## ■ Performance Specifications

Deutsch can only warrant electrical performance when proper parts, procedures, and tooling are used.

### Durability

No electrical or mechanical defects after 100 cycles of engagement and disengagement.

### Current Rating (Contact current rating @ 125° C continuous)

Contact Size	Max. Current
Size 20	7.5 amps
Size 16	13 amps
Size 12	25 amps
Size 8	60 amps
Size 4	100 amps
Ø8mm	150 amps*
Ø12mm	300 amps*

\*Max current is achieved when using max wire gauge only

### Crimp Tensile Strength (Solid)

Contact Size	Tensile Strength
Size 20	20 lbs
Size 16	25 lbs
Size 12	70 lbs
Size 8	90 lbs
Size 4	300 lbs
Ø8mm	367-598 lbs
Ø12mm	639-898 lbs

### Crimp Tensile Strength (Stamped & Formed)

Contact Size	Tensile Strength
Size 20	20 lbs
Size 16	25 lbs
Size 12	70 lbs

### Contact Retention (Solid and Stamped & Formed)

Contacts withstand a minimum load of:

- 20 lbs (89 N) for size 20
- 25 lbs (111 N) for size 16
- 30 lbs (133 N) for size 12
- 35 lbs (156 N) for size 8
- 35 lbs (156 N) for size 4
- 56 lbs (250 N) for size Ø8mm
- 56 lbs (250 N) for size Ø12mm



*A crimp tensile test easily and rapidly identifies a proper crimp.*



### Contact Millivolt Drop

Contact Size	Test Current Amps	Millivolt Drop Solids	Millivolt Drop* S&F
20	7.5	60	100
16	13	60	100
12	25	60	100
8	60	60	N/A
4	100	60	N/A

\*Less drop through wire

## ■ Wire Sealing Ranges

Dimensions are for reference only.

### HD30, HDP20, DRC Series Rear Grommet Sealing Ranges

Contact Size	Normal Seal N-Seal	Thin Seal T-Seal	T-Seal Modified*	Extra Thin Seal E-Seal	E-Seal Modified*
4 4 AWG (21.0mm <sup>2</sup> )	.311-.420 (7.90-10.67)	N/A	N/A	N/A	N/A
4 6 AWG (13.0mm <sup>2</sup> )	.280-.292 (7.11-7.42)	.261-.292 (6.63-7.42)	N/A	.261-.292 (6.63-7.42)	N/A
8 8-10 AWG (8.0-5.0mm <sup>2</sup> )	.190-.240 (4.83-6.10)	.170-.240 (4.32-6.10)	N/A	.135-.220 (3.43-5.59)	N/A
12 10-14 AWG (5.0-2.0mm <sup>2</sup> )	.134-.170 (3.40-4.32)	.113-.170 (2.87-4.32)	N/A	.097-.158 (2.46-4.01)	.097-.158 (2.46-4.01)
16 14-20 AWG (2.0-0.5mm <sup>2</sup> )	.100-.134 (2.54-3.40)	.088-.134 (2.23-3.40)	.088-.106 (2.24-2.69)	.053-.120 (1.35-3.05)	.053-.103 (1.35-2.62)
20 16-20 AWG (1.0-0.5mm <sup>2</sup> )	.040-.095 (1.02-2.41)	.040-.095 (1.02-2.41)	N/A	.040-.095 (1.02-2.41)	.040-.083 (1.01-2.10)

\*Deutsch cavity arrangements 24-29, 24-47, and 24-31 are only available with the modified seals. Arrangement 24-31 Modified E Seal = .053-.106. Please see drawings 0425-016-0000 and 0425-021-0000 for full specifications.

### DT, DTM, DTP Series Rear Grommet Sealing Ranges

Contact Size	Standard Seal	Extra Thin Seal E-Seal
12 10-14 AWG (5.0-2.0mm <sup>2</sup> )	.134-.170 (3.40-4.32)	.097-.158 (2.46-4.01)
16 14-20 AWG (2.0-0.5mm <sup>2</sup> )	.088-.145 (2.23-3.68)	.053-.120 (1.35-3.05)
20 16-20 AWG (1.0-0.5mm <sup>2</sup> )	.053-.120 (1.35-3.05)	N/A

### Quick Connect Series Rear Grommet Sealing Ranges

Contact Size	Standard Seal
16 16-20 AWG	.065-.109 (1.65-2.77)
20 20-24 AWG	.040-.083 (1.02-2.11)
22 22-26 AWG	.030-.054 (.76-1.37)

### AEC Series Rear Grommet Sealing Ranges

Contact Size	Standard Seal	Extra Thin Seal E-Seal
16 14-20 AWG (2.0-0.5mm <sup>2</sup> )	.100-.134 (2.54-3.40)	.053-.120 (1.35-3.05)

### WT Series Rear Grommet Sealing Ranges

Contact Size	Standard Seal
4 6 AWG (13.0mm <sup>2</sup> )	.261-.292 (6.63-7.42)
16 14-20 AWG (2.0-0.5mm <sup>2</sup> )	.065-.109 (1.65-2.77)



Proper wire outside diameters assure water tight seals.

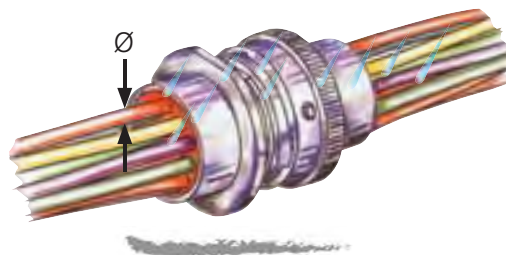





## ■ Wire Sealing Ranges (continued)

Dimensions are for reference only.

### DRB Series Rear Grommet Sealing Ranges

Contact Size	Extra Thin Seal E-Seal
4 6 AWG (13.0mm <sup>2</sup> )	.261-.292 (6.63-7.42)
8 8-10 AWG (8.0-5.0mm <sup>2</sup> )	.135-.220 (3.43-5.59)
12 10-14 AWG (5.0-2.0mm <sup>2</sup> )	.097-.158 (2.46-4.01)
16 14-20 AWG (2.0-0.5mm <sup>2</sup> )	.053-.120 (1.35-3.05)
20 16-20 AWG (1.0-0.5mm <sup>2</sup> )	.040-.095 (1.02-2.41)

### STRIKE Series Sealing Ranges

Contact Size	Standard Seal
Ø12mm 3/0-1 AWG (95-40mm <sup>2</sup> )	.413-.787 (10.50-20.00)
Ø8mm 2-6 AWG (35-16mm <sup>2</sup> )	.283-.472 (7.20-12.00)
12 12-14 AWG (3.0-2.0mm <sup>2</sup> )	.077-.158 (1.96-4.01)
16 14-20 AWG (2.0-0.5mm <sup>2</sup> )	.061-.120 (1.55-3.05)
20 16-20 AWG (1.0-0.5mm <sup>2</sup> )	.061-.095 (1.55-2.41)

### HD10 Series Rear Grommet Sealing Ranges

Contact Size	Standard Seal	Extra Thin Seal E-Seal
4 6 AWG (13.0mm <sup>2</sup> )	.280-.292 (7.11-7.42)	N/A
12 10-14 AWG (5.0-2.0mm <sup>2</sup> )	.134-.170 (3.40-4.32)	N/A
16 14-20 AWG (2.0-0.5mm <sup>2</sup> )	.100-.150 (2.54-3.81)	.053-.120 (1.35-3.05)

### Typical Wire Insulation Ranges

(measured in diameter inches)

Wire Gauge	TXL	GXL	SXL
6	N/A	N/A	.287-.294
8	.178-.185	.209-.221	.222-.236
10	.146-.157	.170-.185	.190-.196
12	.120-.128	.137-.146	.159-.168
14	.098-.105	.114-.122	.138-.145
16	.082-.091	.097-.107	.116-.123
18	.073-.084	.089-.098	.103-.110
20	.065-.072	.080-.087	.092-.099

helpful hint

Proper wire routing assures water tight seal performance.

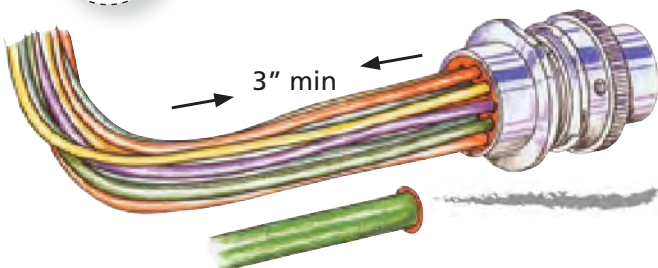

■ Solid Contacts

**Solid Contacts - Common Contact System**

Size	Solid Contact Part Numbers		Wire Size AWG (mm <sup>2</sup> )	Recommended Strip Length Inches (mm)	Min. Contact Retention	Ref Crimp Tensile Lbs. (N)	Max Rated Amps at 125° Continuous
	Pin	Socket					
20	0460-202-20**	0462-201-20**	20 (0.50)	.156-.218 (3.96-5.54)	20 (89)	20 (89)	7.5
20	0460-010-20**	0462-005-20**	16-18 (1.0-0.75)	.156-.218 (3.96-5.54)	20 (89)	20 (89)	7.5
16	0460-202-16**	0462-201-16**	16-20 (1.5-0.50)	.250-.312 (6.35-7.92)	25 (111)	35-20 (156-89)	13
16	0460-215-16**	0462-209-16**	14 (2.0)	.250-.312 (6.35-7.92)	25 (111)	70 (311)	13
12	0460-204-12**	0462-203-12**	12-14 (3.0-2.0)	.222-.284 (5.64-7.21)	30 (134)	75-70 (334-311)	25
8	0460-204-08**	0462-203-08**	8-10 (8.0-5.0)	.430-.492 (10.92-12.50)	35 (156)	125-90 (556-400)	60
4	0460-204-04**	0462-203-04**	6 (13.0)	.430-.492 (10.92-12.50)	35 (156)	300 (1334)	100

\*\* = Plating Codes. Consult factory for custom finish needs.

**Solid Contacts - C038 Modification**

Size	Solid Contact Part Numbers		Wire Size AWG (mm <sup>2</sup> )	Recommended Strip Length Inches (mm)	Min. Contact Retention	Ref Crimp Tensile Lbs. (N)	Max Rated Amps at 125° Continuous
	Pin	Socket					
4	5960-203-04141	5962-203-04141	4 (21.0)	.430-.492 (10.92-12.50)	35 (156)	300 (1334)	100

*Notice*

See information drawing 0425-015-0000. Consult factory for alternate finishes.

**Solid Contact Plating Codes**

Part Number Suffix (**)	Material
31	Gold
90	Nickel (Size 4 pin only)
141	Nickel





## Solid Contacts - STRIKE Series Ø8mm & Ø12mm

Size	Solid Contact Part Numbers		Wire Size AWG (mm <sup>2</sup> )	Recommended Strip Length Inches (mm)	Min. Contact Retention	Ref Crimp Tensile Lbs. (N)	Max Rated Amps at 125° Continuous
	Pin	Socket					
Ø8mm	SRK-PC-080-16-601	SRK-SC-080-16-601	6 (16)	.530-.580 (13.47-14.74)	56 (250)	367 (632)	---
Ø8mm	SRK-PC-080-20-601	SRK-SC-080-20-601	5	.530-.580 (13.47-14.74)	56 (250)	416 (1850)	---
Ø8mm	SRK-PC-080-25-601	SRK-SC-080-25-601	4 (25)	.530-.580 (13.47-14.74)	56 (250)	489 (2175)	---
Ø8mm	SRK-PC-080-32-601	SRK-SC-080-32-601	2	.530-.580 (13.47-14.74)	56 (250)	562 (2500)	---
Ø8mm	SRK-PC-080-35-601	SRK-SC-080-35-601	(35)	.530-.580 (13.47-14.74)	56 (250)	598 (2660)	150
Ø12mm	SRK-PC-120-40-601	SRK-SC-120-40-601	1 (40)	.837-.887 (21.27-22.54)	56 (250)	639 (2840)	---
Ø12mm	SRK-PC-120-50-601	SRK-SC-120-50-601	1/0 (50)	.837-.887 (21.27-22.54)	56 (250)	720 (3200)	---
Ø12mm	SRK-PC-120-70-601	SRK-SC-120-70-601	2/0 (70)	.837-.887 (21.27-22.54)	56 (250)	819 (3640)	---
Ø12mm	SRK-PC-120-95-601	SRK-SC-120-95-601	3/0 (95)	.837-.887 (21.27-22.54)	56 (250)	898 (3990)	300

Deutsch has tested Ø8mm contacts using 35mm<sup>2</sup> wire at 150 amps at 125°C continuous, and Ø12mm contacts using 95mm<sup>2</sup> wire at 300 amps at 125°C continuous. Therefore, these contacts are rated at full current at 125°C using the max wire gauge cable only. The amperage capacities for the remaining Ø8mm and Ø12mm contact options using smaller gauge cable will need to be tested based on individual applications.

Amperage ratings are based on single circuits. The test data does not take into account multiple contacts, mixed wire gauges, and other variables that may be present in an actual application.

### Notice

See information drawing 8925-003-0000 for STRIKE Series. Consult factory for alternate finishes.

### Solid Contact Plating Codes

Part Number Suffix	Material
601	Silver

## Solid Contacts - IMC/QC Series

Size	Solid Contact Part Numbers		Wire Size AWG (mm <sup>2</sup> )	Recommended Strip Length Inches (mm)	Min. Contact Retention	Ref Crimp Tensile Lbs. (N)	Max Rated Amps at 125° Continuous
	Pin	Socket					
22	6860-201-22278	6862-201-22278	22-26	.160-.190 (4.06-4.83)	10 (44)	---	5
20	6860-201-20278	6862-201-20278	20-24	.230-.260 (5.84-6.60)	15 (67)	---	7.5
16	6860-201-16278	6862-201-16278	16-20	.230-.260 (5.84-6.60)	25 (111)	---	13

**Stamp & Formed Contacts**

Size	Stamp & Formed Contact Part Numbers		Carrier Strip Identification	Wire Size AWG (mm <sup>2</sup> )	Wire Insulation O.D. Range	Recommended Strip Length Inches (mm)	Min. Contact Retention	Max Rated Amps at 125° Continuous
	Pin	Socket						
20	1060-20-01**	1062-20-01**	20-01	16-22 (1.5-0.50)	.075-.125 (1.91-3.18)	.150-.200 (3.81-5.08)	20 (89)	7.5
20	1060-20-02**	1062-20-02**	20-02	16-22 (1.5-0.50)	.051-.085 (1.30-2.16)	.150-.200 (3.81-5.08)	20 (89)	7.5
20	N/A	1062-20-03** sleeveless	20-03	16-22 (1.5-0.50)	.075-.125 (1.91-3.18)	.150-.200 (3.81-5.08)	20 (89)	7.5
20	1060-20-06**	1062-20-06**	20-06	14-16 (2.5-1.0)	.075-.125 (1.91-3.18)	.150-.200 (3.81-5.08)	20 (89)	7.5
16	1060-14-01**	1062-14-01**	14-16	14-18 (2.0-.75)	.095-.150 (2.41-3.81)	.150-.200 (3.81-5.08)	25 (111)	13
16	1060-14-10**	1062-14-10**	14-16	14-18 (2.0-.75)	.095-.150 (2.41-3.81)	.150-.200 (3.81-5.08)	25 (111)	13
16	1060-16-01**	1062-16-01**	16-18	14-18 (2.0-.75)	.075-.140 (1.90-3.55)	.150-.200 (3.81-5.08)	25 (111)	13
16	1060-16-06**	1062-16-06**	0.5-1.0	16-20 (1.0-.50)	.055-.100 (1.40-2.54)	.150-.200 (3.81-5.08)	25 (111)	13
16	1060-16-09**	1062-16-09**	16-18	14-18 (2.0-.75)	.075-.140 (1.90-3.55)	.150-.200 (3.81-5.08)	25 (111)	13
16	1060-16-12**	1062-16-12**	1.0-2.5	12-16 (2.5-1.0)	.075-.140 (1.90-3.55)	.175-.225 (4.45-5.72)	25 (111)	13
16	N/A	1062-16-14** sleeveless	14-16	12-16 (2.5-1.0)	.075-.140 (1.90-3.55)	.175-.225 (4.45-5.72)	25 (111)	13
12	1060-12-01**	1062-12-01**	12-14	12-14 (4.0-2.0)	.113-.176 (2.87-4.47)	.225-.275 (5.72-6.99)	30 (134)	25
12	1060-12-02**	1062-12-02**	10-12	10† (6.0-4.0)	.140-.204 (3.56-5.18)	.225-.275 (5.72-6.99)	30 (134)	25

\*\* = Plating Codes. Consult factory for custom finish needs.  
 † = TXL wire insulation is preferred

**S&F Contact Plating Codes**

Part Number Suffix (**)	Material
22	Nickel
44	Gold
66	Tin/Nickel
77	Tin
88	Selective Gold

**Notice**  
 See information drawing 0425-015-0000. Consult factory for alternate finishes.





## PCB Pins

Deutsch Industrial offers a complete line of straight reduced diameter extended pins that may be installed in any of the Deutsch family of connectors. The use of removable contacts provides design flexibility and a low cost alternative to meet application needs. These solid copper alloy pins may be specified in various platings and assembled in HD30, HDP20, HD10, DRC, or DT receptacles.

### Material

Copper alloy

### Plating

31: Gold

90: Tin

141: Nickel

### PCB Mounting

Consult factory for PCB mounting details and pin positions.



### Notice

See information drawing 0425-202-0000 for full specifications.

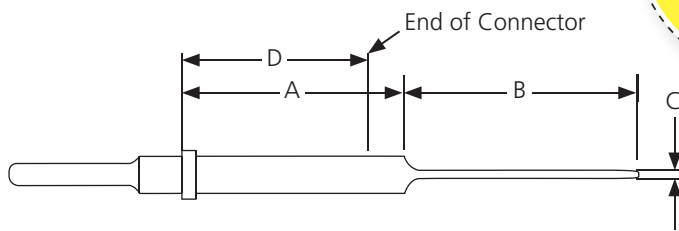

Part Number	A	B	C
0460-208-16**	1.300 (33.02)	.248 (6.30)	.025 (.64)
0460-229-16**	.545 (13.84)	.248 (6.30)	.025 (.64)
0460-238-12**	.714 (18.14)	.549 (13.94)	.043 (1.09)
0460-241-16**	1.305 (33.15)	.160 (4.06)	.040 (1.02)
0460-245-16**	.976 (24.79)	.400 (10.16)	.041 (1.04)
0460-245-12**	1.024 (26.01)	.500 (12.70)	.041 (1.04)
0460-257-16**	.793 (20.14)	.248 (6.30)	.025 (.64)
0460-208-12**	1.305 (33.15)	.248 (6.30)	.025 (.64)
0460-263-16**	1.305 (33.15)	.248 (6.30)	.093 (2.36)

Dimensions are for reference only.

Product	D
HD30/HDP20	.939 (23.85)
HD10	.925 (23.50)
DT	.777 (19.74)
DT04-2P	.677 (17.20)
DT04-3P	.677 (17.20)
DRC	1.063 (27.00)

### Notice

"D" is equal to the distance from the contact shoulder to the end of the connector.



HD10 Series



HDP20 Series



HD30 Series

## Crimping

Crimping is defined as the act of joining a conductor to a pin or socket contact using a mechanical tool to compress and displace metal. In a good crimp joint, there is a mutual flow of metal, causing a symmetrical distortion of wire strands and contact material. A proper crimp will establish mechanical strength and excellent electrical conductivity.

### ■ Crimping Configurations

Stamped & formed contacts use a folded type of crimp (Fig. 1) while solid contacts use a 1, 2, or 4 indenter crimp (Fig. 2). In both styles of crimps, the wire strands and the contact material are formed together in a solid mass creating a reduction of the wire strands area. The reduced wire strand area creates a minimum of voids allowing for excellent conductivity. Crimping may be accomplished with hand tools or power tools.

#### Stamped & Formed Style



Cross-Section Across Axis

Figure 1

#### Solid Style



Indenter Crimp  
Cross-Section Across Axis

Figure 2

### ■ Benefits of Crimped Contacts

Mechanically crimping contacts is the dominant wire termination method, for some very good reasons:

1. With smaller wire, the crimp is as strong as the wire itself.
2. The joint can be visually inspected. Viewing the wire through an inspection hole in the contact makes inspection quick and easy, both by the operator and by the inspector.
3. Plating thickness is not restricted, as in solder joints, so better corrosion resistance and contact reliability are achieved.
4. Crimping can be done anywhere, without special preparation. Terminations are replaced or modified in the field exactly the same as in the shop, using the same tools and the same techniques, and with the same ease of operation and certainty of results.
5. Total installed and maintenance costs are lower.



Solder should not be added to Deutsch terminals.



#### Notice

The use of dielectric grease is not recommended.



## ■ Crimp Inspection

Crimping tools provide lower total installation and maintenance costs. However, controls are required to ensure that the proper crimp tools designed for the type and size contact are used, the pin or socket is properly inserted into the tool, the wire insulation is stripped properly, and the wire fully inserts into the contact.

### Notice

For more detailed crimp dimensions please request a factory drawing. For stamped & formed style see 0425-203-0000. For solid style see 0425-205-0000.

When a crimp is completed, correct termination can be visually inspected. The inspector should check for:

- The removed insulation should expose a conductor length that will pass beyond the inspection hole in the contact and still reveal .100" (2.54) max. of conductor between the contact and the insulation on the wire.
- Wire strands intact.
- All wire strands enter the contact barrel.
- Wire inserted to the proper depth in the contact.

When the correct crimp tool and process are used, a good termination is assured.

## ■ Solid Contact Crimp

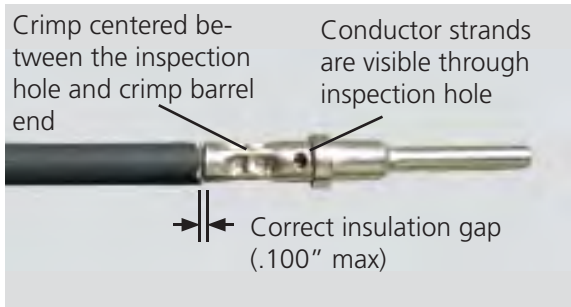

Acceptable Crimp

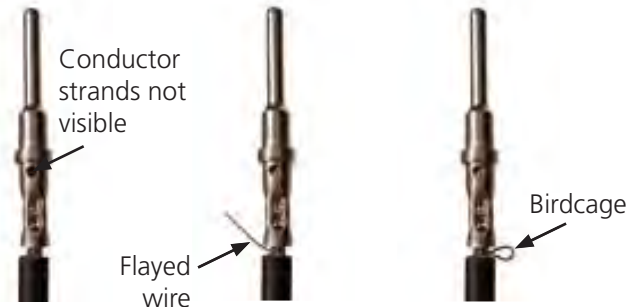

Unacceptable Crimps

## ■ Stamped & Formed Contact Crimp

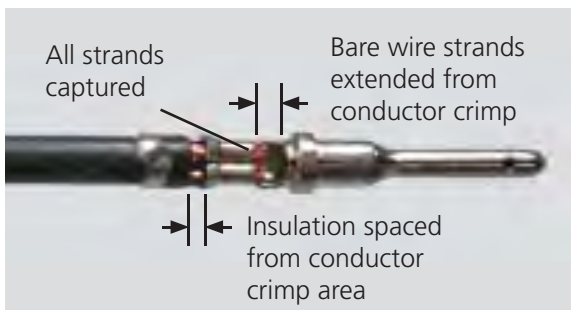

Acceptable Crimp

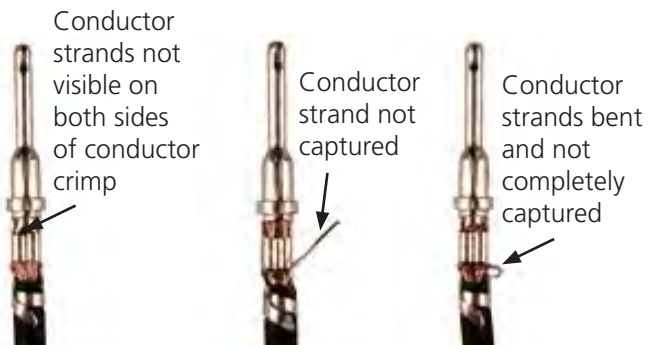

Unacceptable Crimps



## Accessories

The Deutsch Common Contact System is designed to be a reliable easy-to-use combination of pins and sockets. Additional accessories are available to aid in the design flexibility and sealing requirements of applications. Accessory items such as keying pins and sealing plugs assist in maintaining an environmental seal and preventing mis-mating.

### ■ Keying Pins

Keying pins are solid plastic rods used to prevent mis-mating of like connectors in close proximity. Applicable Deutsch product lines include HD10, HD30, HDP20, DT, and DTM Series.

Keying pins are inserted into the retention fingers of an empty socket cavity. Once installed, the keying pin blocks a mating contact pin from being inserted. The contact pin will be blocked before the coupling device mates the connectors, preventing the mis-mating of like connectors. Proper usage requires that the corresponding mating pin be omitted and a sealing plug is inserted in the rear cavity of the mating connector. Individual applications will vary, and testing should be done to determine the best pattern arrangement to prevent improper connector mating.



Part Number	Contact Size	Color
0413-216-2005	20	Red
0413-215-1605	16	White
0413-214-1205	12	Yellow

**Notice**  
Multiple keying pins may be required to prevent unintentional forced mating.

### ■ Contact Crimp Sleeve Reducer

Deutsch offers a crimp sleeve reducer to allow size 4 solid contacts to accept 8-10 AWG wire. When populating a connector using a contact with a reducer sleeve, be sure the insert seal penetrates the rear grommet. The use of the crimp sleeve reducer requires no extra crimp tools and provides an easy transition and increased flexibility.



Insert Seal  
0410-241-0406



Crimp Sleeve  
0421-203-04141

**Notice**  
TXL wire insulation with 10 AWG wire is not recommended because it may not provide an environmental seal against the insert seal.

### ■ Cavity Plug







Silicone cavity plugs are used to fill an unused cavity in a STRIKE Series connector without an integrated rear seal. Filling the unused cavity maintains the integrity of the environmental seal. The -04A cavity arrangement requires a cavity plug if the size 16 cavities are unused.

Cavity Plug	Part Number	Contact Size	Material
	25JH0024	16	silicone



## ■ Sealing Plugs

Open cavities provide pathways for contaminants to enter the connectors. To ensure the integrity of the seal, any unused cavity must be filled with the appropriate size sealing plug.

Sealing Plug	Part Number	Contact Size	Wire Gauge Range	Description
	114019	Size 4	4-6 AWG	silicone rubber, used with Common Contact System
	114018	Size 8	8-10 AWG	thermoplastic, used with Common Contact System
	114017	Size 12, 16	12-20 AWG	thermoplastic, used with Common Contact System
	0413-217-1605 (locking sealing plug)	Size 16	14-20 AWG	thermoplastic, used with Common Contact System, retained by locking fingers
	0413-003-1605	Size 16	14-20 AWG	thermoplastic, used with STRIKE Series
	0413-204-2005	Size 20	20 AWG	thermoplastic, used with Common Contact System
	600300-22	Size 22	22-26 AWG	thermoplastic, used with Quick Connect Series

## How To Instructions

### ■ Sealing Plug Installation

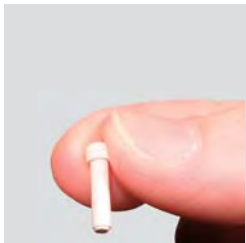

**Step 1:**  
Holding the sealing plug with large diameter end away from the connector, gently apply downward pressure to force the sealing plug into the cavity.

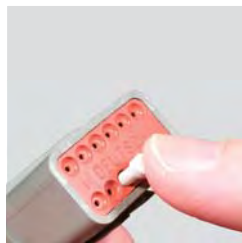

**Step 2:**  
With perpendicular motion, apply downward pressure to the large diameter end of the sealing plug.

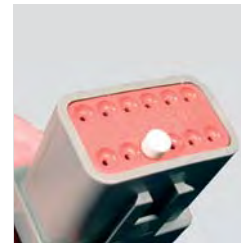

**Step 3:**  
Apply pressure until sealing plug is forced to stop by contact with rear grommet. Visually inspect the sealing plug to ensure it is flush with cavity opening.

## ■ Locking Sealing Plug Installation

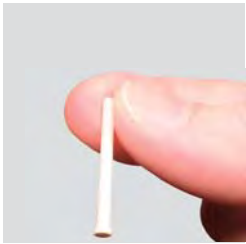

### Step 1:

Holding the sealing plug with large diameter end towards the connector, gently apply downward pressure to force the sealing plug into the cavity.



### Step 2:

With perpendicular motion, apply downward pressure to the small diameter end of the sealing plug.



### Step 3:

Apply pressure until sealing plug locks into place. A slight tug on the sealing plug will ensure it is locked into place.



*Sealing plugs are used to seal the connector when all the cavities are not used by wires.*

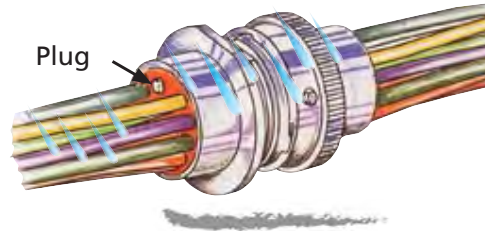

## ■ Contact Crimp Sleeve Reducer Assembly



### Step 1:

Place crimp sleeve reducer into contact barrel.



### Step 2:

Slide insert seal onto 8-10 AWG wire stopping just at the edge of the stripped insulation.



### Step 3:

Insert wire into barrel of contact and crimp using designated tooling.



### Step 4:

Ensure seal is not distorted.





# Tooling

## Contents

Tooling Overview	136
Benefits of Crimping	136
Crimp Inspection	136
Automated Tooling	137-138
Hand Tools	139-140
Removal Tools	141
Series Specific Tools	142-143

How To Instructions	143-145
---------------------	---------

## Tooling Overview

Deutsch Industrial manufactures two types of contacts, solid and stamped & formed. Both styles of contacts are designed for crimp style terminations, no solder is required or recommended. A crimp style termination displaces the wire strands creating a superior bond between the wire and the contact.

Deutsch offers several types of tools to assist with hand and production wire crimping, wire insertion and removal and wedgelock/terminal position assurance removal. The tools are specific to the solid contacts or the stamped & formed contacts. To ensure a proper crimp and achieve the highest performance specifications, Deutsch contacts must be crimped with Deutsch tooling. Deutsch can only warrant electrical performance when proper parts, procedures, and tooling are used.

### ■ Benefits of Crimping

Mechanically crimping contacts is the dominant wire termination method, for some very good reasons:

1. Since no wet process is involved, corrosion is not a problem. No adhesive, flux, or additives are used.
2. Strength, accuracy and overall reliability of a crimped contact are controlled by the crimp tool, not the operator. The field tools (except size 4 solid style) release the contact only after the full crimping cycle is completed.
3. The crimp tool is universal, accepts both pins and sockets of many sizes.
4. Crimping can be done anywhere, without special preparation. Terminations are replaced or modified in the field exactly the same as in the shop, using the same tools and the same techniques, and with the same ease of operation and certainty of results.
5. Total installed and maintenance costs are lower.

### ■ Solid Contact Crimp Inspection

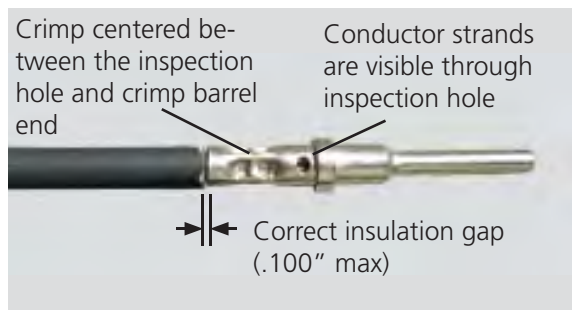

**Acceptable Crimp**

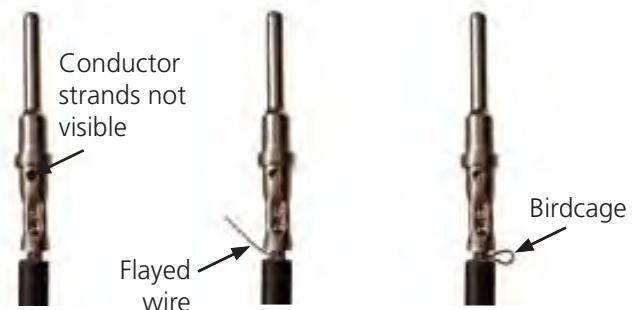

**Unacceptable Crimps**

### ■ Stamped & Formed Contact Crimp Inspection

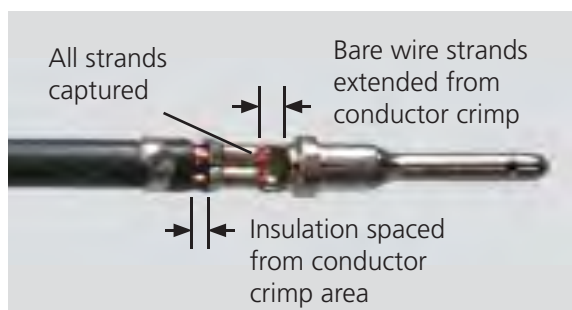

**Acceptable Crimp**

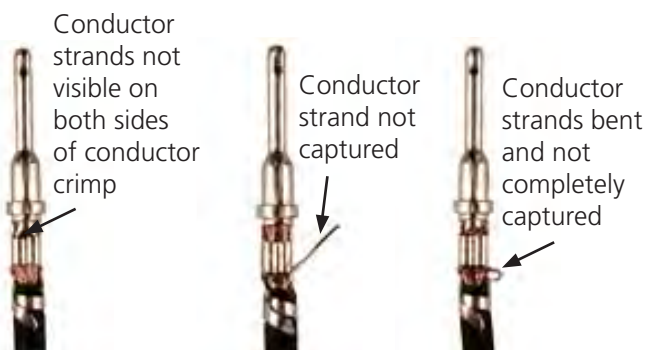

**Unacceptable Crimps**

## Automated Tooling Overview

For higher production volumes, Deutsch offers a pneumatic power crimp tool for the solid contacts, and applicator dies for stamped & formed contacts. The HDP-400, the pneumatic solid crimp tool, is a fast, bench-top tool that crimps all of the contacts in the Deutsch Industrial Common Contact System. The HDP-400 has a foot control, and easy-to-change dies and locators for each contact size. Deutsch's stamped & formed applicator dies are heavy duty mini-dies that work in many industry standard presses. Deutsch's applicator dies offer simple adjustments and the flexibility to accept different sized Deutsch contacts and wire gauge.

### Automated Tooling for Solid Contacts



Tool P/N	Contact Size	Contact Part Number
HDP-400	4	0460-204-0490
		0462-203-04141
	8	0460-204-08141
		0462-203-08141
	12	0460-204-12**
		0462-203-12**
	16	0460-202-16**
		0462-201-16**
		0460-215-16**
		0462-209-16**
20	0460-202-20**	
	0462-201-20**	



#### HDP-400 Dies and Locators

Crimp Tool Part Number	Drawing Number Reference
HDP-400	0425-205-0000

### HDP-400 Tooling Accessories



#### Go-No-Go Gauges

Part Number	Go-No-Go Gauges
GA20N	HDP-400 Size 20
450GA-16N	HDP-400 Size 16
450GA-12N	HDP-400 Size 12
GA8-SPEC	HDP-400 Size 8
450GA-4-SPEC	HDP-400 Size 4



## ■ Automated Tooling for Stamped & Formed Contacts

Tool P/N	Contact Size	Contact Part Number
DCT12-02-00	12	1060-12-01** 1062-12-01**
DCT12-02-01		1060-12-02** 1062-12-02**
DCT16-02-00	16	1060-16-01** 1062-16-01**
DCT1620-02-00		1060-16-06** 1062-16-06**
DCT20-02-00 DCT1620-02-00	20	1060-20-01** 1062-20-01**



### DCT Applicator Punches and Anvils



Applicator Part Number	Drawing Number Reference
DCT12-02-00	0425-208-0000
DCT12-02-01	0425-041-0000
DCT16-02-00	0425-203-0000
DCT1620-02-00	0425-059-0000
DCT20-02-00	0425-207-0000

## ■ DCT Tooling Accessories



### Bolster plate for mounting Deutsch DCT applicators to AMP K press

Part Number	Bolster Plate Accessories
BOLSTER PLATE	Bolster Plate
BOLSTER PLATE BAR	Bolster Plate Bar
BOLSTER PLT CLAMP	Bolster Plate Clamp



### Oiler for DCT Series applicators

Part Number	Oiler Accessories
20000082	Oiler Unit
E807	Terminal Lubricant

## Hand Tool Overview

For field service, prototype, and low-volume production, Deutsch offers several easy-to-use hand crimp tools for both solid barrel and stamped & formed contacts. All Deutsch hand crimp tools provide a tight, complete crimp with minimal effort. The HDT-48-00, the most commonly used tool for solid contacts, crimps a wide range of contact sizes with no need to change out dies or locators. It provides a symmetrical four indent crimp, is compact and easy-to-use for field service, yet sturdy and reliable enough for low volume production. Hand crimp tools for stamped & formed contacts are wire gauge specific and simultaneously crimp the insulation and conductor, saving time and effort during field service.

### Hand Tools for Solid Contacts



HDT-04-08



HDT-48-00



HDT-50-00



HDT-1561

Contact Size	Contact Part Number	Tool Part Number	Crimp Type
4	0460-204-0490 0462-203-04141	HDT-04-08	Two Indent Crimp
8	0460-204-08141 0462-203-08141	HDT-04-08	Two Indent Crimp
12	0460-204-12** 0462-203-12**	HDT-48-00	Four Indent Crimp
		HDT-1561	Two Indent Crimp
		HDT-50-00	One Indent Crimp
16	0460-202-16** 0462-201-16** 0460-215-16** 0462-209-16**	HDT-48-00	Four Indent Crimp
		HDT-1561	Two Indent Crimp
		HDT-50-00	One Indent Crimp
		HDT-48-00	Four Indent Crimp
20	0460-202-20** 0462-201-20**	HDT-1561	Two Indent Crimp
		HDT-50-00	One Indent Crimp
		HDT-48-00	Four Indent Crimp

### HDT-48-00 Hand Tool Accessories

#### HDT-48-00 Adjustment Screw and Locking Nut



Part Number	Crimp Tool Replacement Part
0426-209-0000	Adjustment Screw and Locking Nut
M2700-395-10	Locking Nut

#### Go-No-Go Gauge



Part Number	Description
G454	HDT-48-00 Go-No-Go Gauge



*Go-no-go gauges are used to inspect crimp tooling. The G454 gauge is used with the HDT-48-00 hand tool.*



## ■ Hand Tools for Stamped & Formed Contacts



DTT-12-00



DTT-12-01



DTT-16-00  
DTT-16-01  
DTT-20-00  
DTT-20-02

Contact Size	Contact Part Number	Tool Part Number
12	1060-12-01** 1062-12-01**	DTT-12-00
	1060-12-02** 1062-12-02**	DTT-12-01
16	1060-16-01** 1062-16-01**	DTT-16-00 (14-16 AWG)
	1060-16-06** 1062-16-06**	DTT-16-01 (18-20 AWG)
20	1060-20-01** 1062-20-01**	DTT-20-00
	1060-20-02** 1062-20-02**	DTT-20-02











## ■ DT-RT1

The DT-RT1 is a multi-use tool with a small hook on one end to remove the wedgelock, and a small screwdriver on the other end to push back the locking fingers and release the contact. The DT-RT1 is a helpful tool for the DT, DTM, DTP, DTV, DRB, and STRIKE series of connectors.



## ■ Removal Tools

Deutsch Industrial removal tools are designed to simplify contact removal and field service repair in all connectors that utilize a round shoulder contact retention system. Removal tools are compact, easy-to-use, and manufactured of heavy duty plastic to remove contacts without damage to the wire, insulation, connector seals, or connector body. The removal tools are required for wire removal in the DTHD, Jiffy Splices, HD10, HDP20, HD30, DRC, AEC, and WT Series.

Removal Tool	Part Number	Contact Size	Wire Gauge Range	Color
	0411-027-0405	Size 4	4 AWG	Black
	114009	Size 4	6 AWG	White
	114008	Size 8	8-10 AWG	Green
	0411-353-0805	Size 8 for HD Box	8-10 AWG	Green Extended
	114010	Size 12	12 AWG	Yellow
	0411-337-1205	Size 12	12-14 AWG Extra Thin Wall (E-Seal)	Orange
	0411-291-1405	Size 16	14-16 AWG	Green
	0411-310-1605	Size 16	16-18 AWG	Light Blue
	0411-336-1605	Size 16	16-18 AWG Extra Thin Wall (E-Seal)	Dark Blue
	0411-240-2005	Size 20	20-24 AWG	Red



*A contact removal tool taped or tie wrapped to the harness will make it easily available, should repairs be needed.*

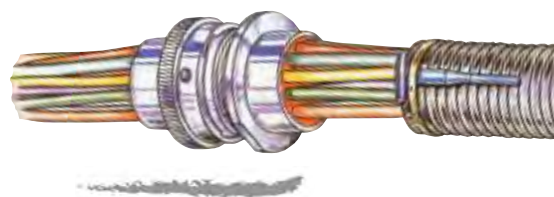

## Series Specific Tools

### ■ Crimp Tools for STRIKE Series



Contact Size	Contact Style	Hand Crimp Tool	Production Crimp Tool
Ø8mm, Ø12mm	Solid	Hex shaped crimp per NFC20.130 standard*	
12-20	Solid	HDT-48-00	HDP-400
12	Stamped & Formed	DTT-12-00, DTT-12-01	DCT12-02-00, DCT12-02-01
16	Stamped & Formed	DTT-16-00, DTT-16-01, DTT-16-02	DCT1620-02-00
20	Stamped & Formed	DTT-20-00, DTT-20-02	DCT1620-02-00

\*See drawing 8925-003-0000 for full specifications.

### ■ Assembly/Removal Tools for STRIKE Series







#### Contact Removal Tools

The STRIKE Series Ø8mm and Ø12mm contacts require the following removal tools.

Tool	Part Number	Connector	Description
	SRK-EXT-80	Plug and Receptacle	Removal tool for Ø8mm contacts
	SRK-EXT-120	Plug and Receptacle	Removal tool for Ø12mm contacts

#### TPA Tools

The STRIKE Series has integrated TPA, which require removal tools. Multiple STRIKE tools may be needed to service a single connector. TPA removal tools are specific to each connector half and some cavity arrangements.

Tool	Part Number	Connector	Description
	SRK-RT-02	Receptacle	TPA removal tool for receptacles Not for use with 18 cavity insert
	SRK-RT-02-G2	Receptacle	TPA removal tool for receptacles For use with 18 cavity insert
	SRK-RT-06	Plug	TPA removal tool for plugs Not for use with 18 cavity insert
	SRK-RT-06-G2	Plug	TPA removal tool for plugs For use with 18 cavity insert
	SRK-MT-02	Receptacle	TPA mounting tool for receptacles
	DT-RT1	Plug and Receptacle	Field service removal tool (TPA or contacts) for plugs and receptacles

## ■ Tools for IMC and Quick Connect Series

The Industrial Micro Connect and Quick Connect Series use special contacts and tools. The contacts are smaller and designed for high pin density. Removal tools along with multiple crimp tools are available and are designed to work with the smaller contacts and tighter pin arrangements. The common contact system and tools are not compatible with the IMC or QC Series.

Tools for Solid Contacts	
<b>Part Number</b>	<b>Adjustable Hand Crimp Tools</b>
MH860	QC/IMC #22 crimp tool, adjustable AWG ranges, requires 86-5
86-5	QC/IMC crimp tool positioner for MH860
AF8-TH163	QC/IMC #20 and #16 crimp tool, adjustable AWG ranges
	<b>Single Gauge Hand Crimp Tools</b>
AMSC22/1	QC/IMC #22 crimp tool, low cost, only crimps 22 AWG wire
AMSC20/1	QC/IMC #20 crimp tool, low cost, only crimps 20 AWG wire
AMSC16/A/1	QC/IMC #16 crimp tool, low cost, only crimps 16 AWG wire
	<b>Insert/Removal Tools</b>
6757-201-2201	Insert/Removal Tool #22
6757-201-2001	Insert/Removal Tool #20
6757-201-1601	Insert/Removal Tool #16



## How To Instructions

### ■ Wire Stripping



#### Step 1:

1. Choose the correct AWG for the contact being used.
2. Measure from the end of the wire the recommended strip length according to the contact size.
3. Place the wire into a stripping tool at the recommended strip length. Strip the wire according to stripping tool instructions.



#### Step 2:

1. After stripping, a small piece of the insulation should come off.
2. Check for any broken strands or for a dent in the wire. If either exist, the wire is damaged and should be cut and stripped again.



#### Step 3:

1. Measure the exposed strands to be sure the crimp length is correct.



*Leaving the stripped portion of the insulation on the wire until prior to crimping will avoid flayed wire strands.*

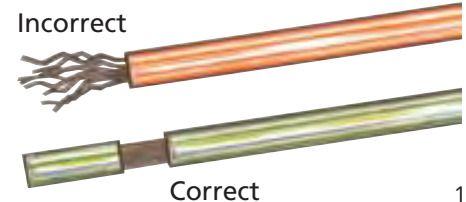



## ■ Crimping with the HDT-48-00 Hand Tool



### Notice

Tool must be adjusted for each type/size of contact.



#### Step 1:

1. Strip insulation from wire.
2. Raise selector knob and rotate until arrow is aligned with wire size to be crimped.
3. Loosen locknut, turn adjusting screw in until it stops.



#### Step 2:

Insert contact with barrel up. Turn adjusting screw counterclockwise until contact is flush with indenter cover. Tighten locknut.



#### Step 3:

1. Insert wire into contact. Contact must be centered between indentors. Close handles until crimp cycle is completed.
2. Release handles and remove crimped contact.

## ■ Crimping with DTT Style Hand Tools (size 16 & 20)



#### Step 1:

Cycle the hand tool to the open position. Place the contact into the correct die nest.



#### Step 2:

Partially close the tool until the contact is held in place.

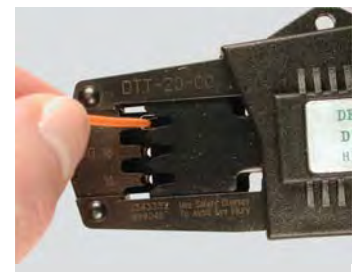

#### Step 3:

Insert the prestripped wire into the crimp area of the contact.

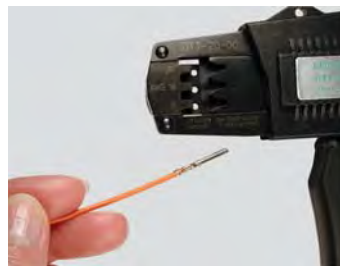

#### Step 4:

Close the tool until the ratchet releases. The ratchet is released when a loud click is heard and crimp is complete.

## ■ Crimping with DTT-12-01 Hand Tool

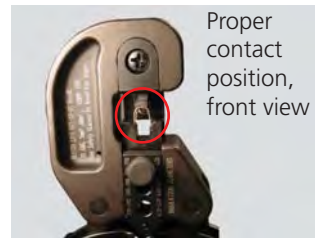
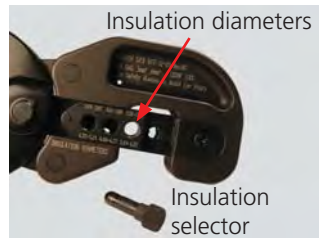

**Step 1:**  
Cycle handles to release ratchet and fully open crimp jaws. Pull out insulation selector and push into proper diameter using the chart below.

**Step 2:**  
1. Insert contact into locator. Adjust alignment and width of crimp wings if necessary to ensure capture by crimp jaws.  
2. Insert stripped wire into the contact. Close crimp tool until full-cycle ratchet control releases.

Wire Type	Insulation Selector
10 TXL	.150-.170
10 GXL	.160-.180
10 SXL	.170-.205
5.0 mm <sup>2</sup>	.160-.180
6.0 mm <sup>2</sup>	.170-.205

## ■ Crimping with DTT-12-00 Hand Tool



**Step 1:**  
Cycle the tool to release ratchet and open tool. Lift the locator gate, and place the contact into the correct die nest. Adjust alignment of crimp wings to ensure capture by crimp jaws.



**Step 2:**  
Partially close the tool until the contact is held in place.



**Step 3:**  
Insert the prestripped wire into the crimp area of the contact.



**Step 4:**  
Close the tool until the ratchet releases. The ratchet is released when a loud click is heard and crimp is complete.







# Additional Resources

## Contents

Modification List 148-149

---

Requirements & Standards 150

---

Glossary 151-156

---

Index 157-159

---



## Modification List

Mod #	Series	Description
<b>059</b>	HD30	Addition of threaded adapter and cable clamp assembly
<b>072</b>	HD30	Addition of threaded adapter
<b>A004</b>	DRC	Receptacle with molded-in PCB pins, 24 and 40 way
<b>AG02</b>	PCB	Some terminals are gold plated
<b>B010</b>	HD10	Plug with coupling ring added
<b>B016</b>	DT, DT13/15	Receptacle has extended shell and additional keys, plug has enhanced seal retention (P012), 12 way
<b>B022</b>	HD10	Receptacle with D-hole panel mount, J1939, black
<b>B026</b>	DTMF15	PCB receptacle with alternate keying position
<b>B028</b>	DT	Grommet around PCB pins to meet 5 psi requirement
<b>BE01</b>	DT	Receptacle has extended shell, additional keys and end cap, plug has enhanced seal retention (P012), 12 way
<b>BL04</b>	DT	Receptacle with extended shell and additional keys (B016), welded flange
<b>BL08</b>	DT	Receptacle with extended shell and additional keys (B016), welded flange, black
<b>BL10</b>	DT	Receptacle with extended shell and enhanced keys (B016), sealed flange, reduced diameter seals (E seal), shrink boot adapter, threaded stainless steel flange inserts
<b>BP03</b>	HD10	Receptacle with D-hole panel mount, J1939 Type II, green
<b>C015</b>	DT	Reduced diameter seals (E seal)
<b>C023</b>	PCB	5mm <sup>2</sup> threaded insert mounting holes
<b>C030</b>	HD30, HDP20	Four size 16 cavities blocked (1, 2, 5, 6)
<b>C038</b>	HDP20	Three size 4 cavities, four size 16 cavities, requires 5960-203-04** and 5962-203-04** size 4 contacts
<b>CL03</b>	DT	Reduced diameter seals (E seal), welded flange
<b>CL07</b>	DT	Reduced diameter seals (E seal), sealed flange, shrink boot adapter
<b>CL09</b>	DT	Reduced diameter seals (E seal), sealed flange, end cap, black
<b>E003</b>	DT, DTHD, DTM, DTP	End cap
<b>E004</b>	DT, DTM, DTP, HD10	Connector body black
<b>E005</b>	DT, DTM	Connector body black, end cap
<b>E007</b>	DTM	Shrink boot adapter
<b>E008</b>	DT	Shrink boot adapter
<b>E016</b>	EEC	Standard EEC box, molded in transparent Ultem material
<b>EE04</b>	DTM	High temp 150° C, black
<b>EE05</b>	DT	High temp 150° C, end cap, plug has enhanced seal retention (P012), black

Mod #	Series	Description
G002	DRC	Outside rows of pins are gold plated and rest are tin plated
G003	DTM13/15, STRIKE	Gold plated pins
GR01	DTM13 (EEC headers)	Snap-in DTM PCB mounted header for EEC enclosure, 12 and 24 pins , gold plated pins
GR02	DT13 (EEC headers)	Snap-in DT PCB mounted header for EEC enclosure, 12, 24, 36, and 48 pins, gold plated pins
L006	HD30	059 modification using adapter without drain holes
L009	DTHD	Sealed flange, inside mount
L012	DT, DTP, DTM	Welded flange
L013	DTHD	Sealed flange, outside mount
L015	HDP20	Threaded adapter for backshell strain relief
L017	HDP20	Ring adapter for backshell strain relief
L018	DRB	Wire router
LE01	DT	Sealed flange, inside mount, gasket, end cap
LE05	DT	Sealed flange, inside mount, gasket, end cap
LE06	DT	Sealed flange, inside mount, reduced diameter seals (E seal), end cap
LE07	DT, DTP	Welded flange, end cap
LE08	DT	Welded flange, shrink boot adapter (J1939), gray
LE09	DT	Sealed flange, o-ring, end cap, black
LE10	DT	Sealed flange, inside mount, gasket, end cap, black
LE11	DT	Welded flange, end cap, black
LE12	DT	Welded flange, shrink boot end cap (J1939), black
LE14	DT	Welded flange, black
LE17	DT	Sealed flange, gasket sold separately, end cap, black
LE21	DT	Receptacle with extended shell and enhanced keys (B016), sealed flange, reduced diameter seals (E seal), end cap, one piece connector design, threaded stainless steel flange inserts
N005	HD10	Receptacle with molded in PCB pins, modified shell
N012	DRC	One piece connector design
P012	DT	Plug with enhanced seal retention, 2-6 way are black, 8 and 12 way "A" key is gray, "B" key is black, "C" key is green, "D" key is brown
P064	HD30, HDP20	24-91 arrangement without internal jumper
P080	HD10	J1939 Type II, green
R008	DTM13 (EEC headers)	Snap-in DTM PCB mounted header for EEC enclosure, 12 and 24 pins
R015	DT13 (EEC headers)	Snap-in DT PCB mounted header for EEC enclosure, 12, 24, 36, and 48 pins

**Notice**  
 For additional modifications, please consult the factory.



# Requirements & Standards

## ■ Requirements

### IMDS

The International Material Data System (IMDS) is a collective, computer-based material data system developed as a collaborative effort by large automotive OEMs to manage environmentally relevant aspects of parts used in vehicles. It has been adopted as the global standard for reporting material content in the automotive industry. IMDS was originally developed in response to the European ELV directive. Deutsch Industrial recognizes IMDS and will work with customers that use the system.

### RoHS

RoHS is a European directive on the Restriction of Hazardous Substances in electrical and electronic equipment. The directive restricts the use of lead, mercury, cadmium, hexavalent chromium, polybrominated biphenyls, and polybrominated diphenyl ether in new electrical and electronic components. All Deutsch Industrial products and LADD Industries' boots, backshells, and gaskets are RoHS compliant.

## ■ Standards

### IP Rating

The IP Rating system is a way of classifying the degree of protection provided against the intrusion of solid objects, dust, and water in electrical enclosures. Deutsch Industrial connectors do not have a published IP rating, but their 3 foot submersion rating comes close to meeting the requirements of IP 67. The 6 in IP 67 means that the connectors have to be completely sealed from fine dust which they are. The 7 in IP 67 means that the connector needs to be protected from the effects of a one meter submersion. Deutsch connectors are rated for three feet submersion, which is just short of the one meter requirement.

### IP 6K9K

IP 6K9K is similar to the standard IP Ratings, but is commonly referred to as a pressure washing spec. The letter K is used after the numbers to denote special testing. The 6K means the connectors need to be completely sealed from fine dust. The 9K means the connector needs to be protected from the penetrating effects of water used for high pressure/steam jet cleaning purposes. Several connectors in the DT, DTM, DRC, and DRB series have been through independent lab testing and pass IP 6K9K.

### J1939/11, J1939/13, and J1939/15

See CAN section.

### UL Recognized

A UL Recognized component is one that is expected to be installed within a larger assembly by a manufacturer, and this larger assembly is then expected to be tested by UL to become UL Listed. Many Deutsch Industrial connectors are UL Recognized including the AEC, DRC, DT, DTM, DTP, HD10, and HDP20 Series. Not every variation and/or modification within a series may be UL Recognized.



# Glossary

**AWG (American Wire Gauge):** Standardized system of wire diameter measurement. Commonly referred to as wire gauge. (Reference: National Bureau of Standards, Copper Wire Table [Handbook 100] AVS.)

**Adapter:** Device attached to a connector to allow connection to a second device that it would not otherwise be able to attach to. In the HD30 Series, a threaded adapter is swaged onto the connector to allow rear hardware, cable clamps, or backshells to be attached. Adapter in HD30 Series is designated by the -072 modification.

**Ambient Temperature:** The temperature of a medium (gas or liquid) surrounding an object.

**Ampere (AMP):** The unit of current. One ampere is the current flowing through one ohm of resistance at one volt potential.

**ARC Resistance:** Time required for an electrical current to render the surface of a material conductive due to carbonization by the arc flame. Or, the time required for an arc to establish a conductive path in a material.

**Applicator:** Tooling used in automatic machines to crimp stamped and formed contacts.

**Backshell:** A secondary attachment for the rear of a connector to provide strain relief, environmental protection, and/or improved aesthetics.

**Barrel:** (1) Conductor Barrel: the section of the terminal, splice, or contact that accommodates the stripped wire. (2) Insulation Barrel: the section of the terminal, splice, or contact that accommodates the unstripped wire.

**Barrel Chamfer:** Beveled entry at mating end of the socket contact. Reduces contact mating force for easier connector mating.

**Blocked Cavities:** Unused holes or contact positions in a connector which have been filled with sealing plugs or made inaccessible by modification to the rear grommet.

**Breakaway:** Connector with a slotted coupling ring. Coupling ring is intended to fragment and allow connectors to separate without damage to the implement in the event of an unintended pull-away. Commonly used in HD Series (HDB prefixed part numbers).

**Boot:** Attachment for the back of a connector. Boots are typically flexible, made from plastic or plastisol, and may provide wire strain relief, environmental protection, and/or improved aesthetics.

**Bulkhead:** Dividing wall or partition. Bulkhead connectors are designed to be mounted to a dividing wall through a cutout.

**Buss (also bussbar, bus or busbar):** A thin conductive strip connecting multiple contacts within the body of a connector. Used to distribute electrical current to the branches of a circuit.

**Cable Clamp:** An attachment to provide support and strain relief to the wire bundle where it exits the connector. In the HD30 Series, the cable clamp is designated by the -059 modification, which includes the -072 adapter modification.

**Cavity:** Hole in the connector grommet and housing, into which the contact must fit.

**Cold Heading:** Process by which contacts are formed from individual pieces of metal using dies and punches.

**Compression Nut:** Secondary backshell assembly. Threads onto rear of backshell to compact wire bundle and provide additional support.



**Conductivity:** The capability of a material to carry an electrical current.

**Conductor:** Any material capable of carrying an electrical charge easily. The most common materials for wire and cable applications are aluminum and copper (bare or coated).

**Contact:** Conductive device crimped or soldered onto the end of conductor wire to allow the transfer of electricity or data to a second conductor. Contacts are most frequently used in multiples in connectors. Also commonly referred to as terminals, pins and/or sockets.

**Contact, Crimp:** Wire termination engineered to be permanently applied to conductor wire end with pressure. Does not use solder or heat.

**Contact, Insertable/Removable:** Wire termination that can be mechanically joined to or removed from the connector body.

**Contact, Pin:** Wire termination with solid mating end. Provides connection by insertion into a female or socket contact. Also referred to as male contact.

**Contact, Socket:** Wire termination with hollow mating end into which the pin or male terminal is inserted. Also referred to as a female contact.

**Contact, Solder:** Wire termination joined to the wire conductor with a metal joining compound. Contacts intended for solder will typically have a cup, hollow-cylinder eyelet or hook to accept a conductor and retain the applied solder.

**Contact Area:** The area where two conductors, a wire termination and a conductor, or two wire terminations touch, permitting the flow of electricity.

**Contact Arrangement:** The number, spacing, and organization of cavities in a connector.

**Contact Rating:** The maximum recommended amperage to be passed through a wire terminal.

**Contact Resistance:** The measurement of opposition to electrical flow through a pair of mated wire terminations. Resistance may be measured in ohms or in millivolt drop at a specified current over the mated terminals.

**Contact Retention:** The axial load in either direction that a terminal can withstand without being dislodged from its correct position in the connector.

**Contact Shoulder:** A small flange or collar on a terminal that limits the contact's travel into or removal from the connector.

**Contact Size:** Overall size of barrel determined by size of wire it will accept.

**Corrosion Resistance:** The ability of a substance to withstand corrosion.

**Coupling Ring:** Attached cylindrical ring used to lock mated connectors together.

**Crimping:** To mechanically secure a terminal or splice to a conductor by use of pressure.

**Crimping Die:** The part of a crimping tool that physically compresses the contact barrel and shapes the crimp.

**Crimp Tool:** Implement that permanently attaches a contact to a wire using pressure.

**Current (I):** The rate of transfer of electricity usually expressed in amperes.

**Current Rating:** The maximum continuous electrical flow of a current recommended for a given wire situation. Expressed in amperes.

**Dielectric Strength:** The voltage which an insulating material can withstand before breakdown occurs, usually expressed as a voltage gradient (such as volts/mil).

**Dielectric Test:** A test in which a voltage higher than the rated voltage is applied for a specific time to determine the adequacy of the insulation under normal conditions.

**Dielectric Withstanding Voltage:** The amount of leakage current that flows through the insulation.

**Diode:** Electronic component that allows electrical flow in one direction only.



**Direct Current:** An electrical current that flows in one direction only.

**Dust Cover:** Cap used to protect and conceal the interface of an unmated connector.

**“E” Seal:** Reduced diameter insert cavity in the rear grommet. Creates a proper seal with smaller than standard wire or insulation. Also referred to as extra thin or European seal. “E” seals are smaller than “N” and “T” seals.

**End Cap:** A protective cover integral to, or sonically welded onto the rear of a connector.

**Engaging and Separating Force:** Measured pull required to mate or unmate contacts or connectors.

**Enhanced Key:** Additional indexing or polarization to prevent mis-mating. In the DT Series it is designated by the B016 modification.

**Enhanced Seal Retention:** Modification to the plug, front seal, and wedgelock to prevent the seal from separating from the connector during unmating.

**Environmentally Sealed:** Maintains functionality when exposed to environmental elements.

**Extraction Tool:** An implement for removing contacts from a connector.

**Flange:** A flat, perpendicular extension of the connector body. Flanges are used for mounting and are typically found on receptacles.

**Flange Seal:** Elastomeric silicone seal used between flange and mounting surface to prevent leakage around the mounting cutout.

**Front Seal:** Elastomeric silicone seal or o-ring on the mating face of a connector. The front seal is also referred to as an interfacial seal and is usually found on the plug.

**Grommet:** Rubber or elastomeric seal. On Deutsch connectors the grommet is on the rear or cable end of the connector and has the cavities through which the contact is inserted into the connector body.

**Ground:** A conducting connection between an electrical circuit and the earth or other large conducting body to serve as an earth thus making a complete electrical circuit.

**Heat Seal:** In cabling, a method of sealing a tape wrap jacket by means of thermal fusion.

**Heat Shrink:** Type of tubing that shrinks to form a tight bond when heated.

**Indenter:** The part of a crimp tool or die that compresses the contact barrel onto the conductor.

**In-line:** Connectors that are not intended for use in mounted or PCB applications.

**Insertion Tool:** A device used to guide contacts into proper position within a connector.

**Inspection Hole:** An opening in a barrel contact to allow visual inspection of the conductor to verify that it has been inserted to the right depth.

**Insulation Resistance:** The measure of resistance offered by insulation material to the flow of current.

**Insulation:** A material having high resistance to the flow of electric current.

**Insulation Crimp:** (1) The physical deformation of the insulation sleeve covering a terminal or splice and the adjacent conductor insulation to hold the sleeve in place (2) Shape combination of insulation sleeve to terminal or splice and conductor insulation after crimping.

**Insulation Resistance:** That property of an insulating material which resists electrical current flow through the insulating material when a potential difference is applied.

**Insulation Support:** The portion of the contact barrel enclosing but not crimped to the conductor insulation.

**Interface:** The surfaces of a mating pair of connectors that face each other when connected.

**Interfacial Seal:** A multiple ribbed seal at the mating edge of the connector to prevent ingress of moisture or contaminants when a connector is properly mated.



**Internal Seal:** Waterproof form, typically made of silicone elastomer, that is inside the body of the connector. Provides moisture and fluid resistance when connectors are properly mated.

**Jacket:** An outer nonmetallic protective covering applied over an insulated wire or cable.

**Key:** Unique pattern of corresponding notches and projections on a set of mating connectors. The projections are intended to match the notches and prevent mis-mating.

**Keying Pin:** Solid plastic rod designed to be inserted into an empty socket cavity to prevent mis-mating.

**Locator:** A device in a crimp tool to assure proper contact position during crimping.

**Lockwasher:** Thin metal ring used between the panel nut and mounting surface to create spring force to ensure a tight fitting mount.

**Millimeters Squared or mm<sup>2</sup>:** Unit of measure for European Wire Size Standards (ref. DIN 72551-6 and ISO 6722-3).

**Moisture Resistance:** Amount of water (in any form) that a properly wired and mated connection will withstand without loss of electronic qualities or leakage.

**Mounting Bracket:** A rectangular metal device used to attach or mount connectors in an application. Mounting brackets are used with the HDFB connectors.

**Mounting Clip:** A plastic or metal piece that attaches to a non-flanged connector to allow surface mounting. Deutsch Industrial mounting clips are used with DT, DTM, DTP, DTHD Series receptacles.

**“N” Seal:** Normal wire seal diameter.

**Neoprene:** Thermosetting material, chemically known as polychloroprene, with excellent flame retarding and abrasion resisting qualities.

**Nest:** The part of a crimping die that supports the barrel during crimping.

**Newton (N):** A unit of force which is based on the metric system. It is the force that produces an acceleration of 1 meter per second per second when exerted on a mass of 1 kilogram.

**O-ring:** Circular seal found around the inside diameter of a receptacle: typically made from elastomeric or silicone material. Provides an environmental seal.

**Oxidation:** The process of uniting a compound with oxygen, usually resulting in an unwanted surface degradation of the material or compound.

**Panel Nut:** A hexagonal threaded plastic or metal ring. Along with a lockwasher, a panel nut is used to mount HD10, HD30 and HDP20 receptacles in an application.

**Partial Strip:** A quantity less than a standard full reel of stamped and formed contacts.

**PCB (Printed Circuit Board) Mount:** Connectors designed for wire to printed circuit board applications.

**Peak Voltage:** The maximum instantaneous voltage.

**Plating:** Thin overlay coating of metal on contacts or components. Can be used to improve conductivity, provide for easy soldering, and prevent corrosion.

**Plug:** One half of a mated pair of connectors. Deutsch plugs typically have the locking mechanism for the mated pair, usually house the sockets, and mate with a receptacle.

**Pre-Tinned:** Solder applied to the contact and/or conductor prior to soldering.

**Pull-Out Force:** Measured energy required to separate a conductor from a contact, or a contact from a termination assembly.

**Ratchet Control:** A crimping device that assures a full crimping cycle by allowing motion in only one direction until contact is fully crimped.

**Receptacle:** One half of a mated pair of connectors. Deutsch receptacles mate with a plug and usually house pins.

**Reduced Diameter Seal:** Smaller than standard holes in the connector grommet. In the Deutsch DT Series this is designated by the C015 modification. In the HD30 and HDP20 Series this is indicated by "T" or "E" seal.

**Removal Tool:** Device to disengage contacts from connector body.

**Retaining Bolt:** Screw used to draw and hold mating connectors together.

**Retaining Sleeve:** Lining sheath that fits into receptacle body to maintain internal seal and provide keying.

**Reverse Arrangement:** Non-standard cavity/contact assignment (eg. Plug connectors that require pin contacts, and receptacles that require socket contacts.) Reverse arrangements are available in the Deutsch HD30 and HDP20 Series and are used to prevent mis-mating where there are multiple similar connectors in close proximity.

**Ring Adapter (HDP20):** Cylindrical rim or collar attached to the rear of a connector to allow the attachment of backshells or strain relief. In the HDP20 Series this is designated by the L017 suffix.

**Sealed Flange:** A flange that is molded or tooled as an integral part of the connector body to help prevent leakage at the mounting site.

**Sealing Plug:** A non-conductive dummy pin inserted to fill an open cavity in a connector. Sealing plugs are required in Deutsch connectors to maintain the integrity of the environmental seal.

**Seamless Terminal or Splice:** Terminal or splice conductor barrel made from a single piece of metal, finished without lines or grooves that would typically appear where metal is joined to metal.

**Secondary Lock:** Device inserted into or onto the connector interface to position and hold contacts in correct alignment. Deutsch Industrial secondary locks are called wedgelocks or terminal position assurance and are used with the DT, DTM, DTP, DTV, DRB, and STRIKE Series.

**Self-Extinguishing:** The characteristic of a material whose flame is extinguished after the igniting flame is removed.

**Selective Plating:** Application of a thin coating of a finish metal to specific parts of a contact, but not to others. If selective plating is used, plating is typically applied to the mating surface to provide better conductivity and reduce wear and corrosion.

**Shells:** Outside case into which the insert and contacts are assembled. Shells of mating connectors usually also provide proper alignment and protection of projecting contacts. Also known as housing or body.

**Shield:** A metallic layer, commonly aluminum or copper, of tape, braid or spiral wrapped wire construction. Its primary purpose is to prevent electrostatic or electromagnetic interference between adjacent wires and external sources.

**Shielded Cable:** A cable in which the insulated conductor or conductors is/are enclosed in a conducting envelope or envelopes. Constructed so that essentially every point on the surface of the insulation is at ground potential or at some predetermined potential with respect to ground.

**Shrink Boot Adapter:** Thermoplastic rear adapter designed to provide a lip for heat shrink to form around to attach it securely to a connector. Commonly used in the Deutsch DT family of connectors.

**Signal:** An electric current used to convey information either digital, analog, audio or video.

**Sleeving:** A braided, knitted or woven tube.

**Splice:** A connection of two or more conductors or cables to provide good mechanical strength as well as good conductivity.

**Socket Contact Sleeve:** A cylindrical, protective encasement for the contact fingers or a contact spring. The socket contact sleeve holds the inner mechanism of the contact in place and provides a smooth exterior surface.

**Solderless Connection:** Joint between two metals created by pressure without the use of metallic alloy compounds or heat.

**Solid Contact:** Closed barrel terminal manufactured using a cold heading process.

**Stamped & Formed Contact:** Open barrel terminal manufactured using a precision stamping process.



**Strain Relief:** Hard plastic or metal device that attaches to the rear of a connector to provide wire support.

**Strand:** A single filament of uninsulated wire.

**Strip:** To remove insulation from a conductor.

**Swedge:** A cold-forging process to press-fit or force two metal forms into one. Deutsch and LADD use a swedging process to force adapters onto the back of HD30 connector bodies.

**“T” Seal:** Reduced diameter insert cavity in the rear grommet. Also referred to as thin seal, a “T” seal allows for the use of smaller wire or thinner insulation diameter. A “T” seal is larger than an “E” seal and smaller than an “N” seal.

**Temperature Coefficient of Resistivity:** The change in resistance per degree of change in temperature.

**Terminal:** A device designed to attach to the end of a conductor wire to allow it to connect to another conductor wire and allow electrical current to pass between them. Also commonly referred to as a contact.

**Terminating Resistor:** A connector that includes a device to create electrical resistance. Commonly used on J1939 applications to end the main trunk line or bus network.

**Thermal Cycling:** Temperature modulation process developed to improve the performance, strength, and longevity of a variety of materials.

**Threaded Adapter:** A cylindrical device with screw threads attached to rear of connector to allow the attachment of a threaded backshell or strain relief. In the HDP20 connectors it is designated by the L015 modification.

**Threaded Rear:** Screw threads at the non-mating end of a connector to allow the attachment of a threaded backshell or strain relief.

**Terminal Position Assurance (TPA):** A secondary locking mechanism. Snapped into place on the mating face of a connector after the connector is populated, a TPA holds contacts in correct alignment for mating and prevents them from being removed.

**Vibration:** A periodic motion of the particles of sound or other waves.

**Volt:** A volt is the unit of electromotive force or electric pressure, a kin to water pressure in pounds per square inch.

**Voltage:** The term most often used to designate electric pressure that exists between two points and is capable of producing a flow of current when a closed circuit is connected between the two points.

**Wedglock:** A Deutsch device inserted into or onto the mating face of a connector to position and hold contacts in correct alignment. In Deutsch Industrial these are used with the DT, DTM, DTP, DTV, and DRB Series.

**Wicking:** The longitudinal flow of a liquid in a wire or cable construction.

**Wiping Action:** Movement of two electrical contacts sliding against each other.

**Wire Range:** The limits of conductor size accommodated by a contact barrel. Also applies to the insulated conductor diameter accommodated by a sealing grommet.

**Wire Router:** Protective device attached to the rear of connector to provide wire bundle strain relief.



# Index

## A

### Adapters

- 072 adapter 85
- IMC Series 116
- L015 conduit adapter 86
- L015 threaded adapter 84
- L017 ring adapter 84
- Quick Connect Series 110
- Shrink boot adapter 23

### AEC Series 95–97

## B

### Back fittings

- Quick Connect Series 110

### Backshells

- DRC Series 65
- DT Series 26
- HD10 Series 76
- HD30/HDP20 Series 85–86
- STRIKE Series 103
- WT Series 93

### Boots

- DRB Series 71
- DRC Series 65
- DT/DTM/DTP Series 25
- HD30/HDP20 Series 85
- IMC Series 116

### Breakaway connector

- HD30 Series 48, 84

### Bussing Options 37–41

## C

### Cable attachments

- STRIKE Series 102

### Cable clamps

- HD30 Series 85

### CAN (Controller Area Network) 43–48

### Cavity plug 102, 131

### Common Contacts 119–133

### Compression nuts

- HD10 Series 76
- HD30/HDP20 Series 86

## Contacts

- Solid 125–126
  - IMC Series 117
  - Quick Connect Series 112
  - STRIKE Series 105
- Stamped & formed 127

### Contact specifications 122

### Coupling rings

- HD10 Series 75

### Crimp

- General 129
- Inspection 130
- Tools 137–140

### Crimp sleeve reducer 131

### Crimp tools. *See also* Tooling

- Automated 137–138
- Hand 139–140
- STRIKE Series 103, 142

## D

### D hole punch 88

### Dimensions

- AEC Series 96
- Bussed feedback receptacles 38
- DRB Series 68
- DRC Series 63
- DT/DTM/DTP Series 19
- DTHD Series 14
- DTMH Series 29
- DTMN Series 30
- DTV Series 28
- EEC enclosures 56–57
- HD10 Series 74
- HD30/HDP20 Series 80
- HDFB Series 40
- IMC Series 114
- Jiffy Splices 16
- Quick Connect Series 108
- STRIKE Series 100
- WT Series 92

### Diodes 33–35

### DRB Series 67–72

### DRC Series 61–66

### DT/DTM/DTP Series 17–27

**DTHD Series 14–15**

**DTMH Series 29**

**DTMN Series 30**

**DTT Style Hand Tools 140, 144–145**

**DTV Series 28**

**Dust caps**

AEC Series 97

DT/DTM Series 24

HD10 Series 77

HD30/HDP20 Series 85

IMC Series 116

Quick Connect Series 109

## E

**EEC enclosures 56–57**

**End caps**

DTHD Series 15

DT Series 23

**“E” seal**

DT Series 23

HD30/HDP20 Series 82–83

## F

**Flange modifications**

DTHD Series 15

DT Series 23

**Flanges**

DRB Series 70

Quick Connect Series 110

## G

**Gaskets**

DRC Series 66

DT/DTM/DTP Series 24

HD10 Series 77

HD30/HDP20 Series 87

Quick Connect Series 110

**Grommet sealing ranges 123–124**

## H

**HD10 Series 73–78**

**HD30/HDP20 Series 79–90**

**HDFB Series 40–41**

## I

**IMC Series 113–117**

**Instructions (How To)**

Crimp sleeve reducer 133

DRB Series 71–72

DT Family 31

DTT style hand tools 144–145

HD30/HDP20 Series 89

HDT-48-00 hand tool 144

Jiffy Splice 16

Sealing plugs 132–133

STRIKE Series 106

Wire stripping 143

**ISO box 48**

## J

**J1939**

J1939/11 46

J1939/12 48

J1939/13 45

J1939/15 47

**Jiffy Splices 16**

## K

**Keying pins 131**

## L

**Lanyards**

HD10 Series 78

Quick Connect Series 109

**Lockwashers**

HD30/HDP20 Series 87

WT Series 94

## M

**Material specifications 7**

**Modifications**

Descriptions 148–149

059 85

072 85

A004 51

AG02 51

B010 75

B016 22, 53

B026 55

BL04 23

BL08 23

BL10 23

C015 23

C023 51

C030 84

CL03 23

CL07 23

CL09 23

E003 15, 23

E004 23, 75

E005 23

E007 23

E008 23

E016 56

Flange 23

G002 51

G003 53, 54

GR01 56

GR02 57

L006 85

L009 15

L012 23

- L013 15
- L015 84
- L017 84
- L018 68
- LE01 23
- LE05-LE12 23
- LE14 23
- LE17 23
- LE21 23
- N005 55
- N012 51
- P012 22
- P064 83
- R008 56
- R015 57
- Mounting brackets 41**
- Mounting clips**
  - DT/DTM/DTP Series 27
  - DTHD Series 15
- N**
- “N” seal**
  - HD30/HDP20 Series 83
- O**
- O-ring**
  - WT Series 94
- P**
- Panel nut**
  - HD30/HDP20 Series 87
  - Quick Connect Series 110
  - WT Series 94
- PCB pins 117, 128**
- PCB (Printed Circuit Board) 49–59**
- Performance specifications**
  - Connectors 6
  - Contacts 122
- Protective caps. *See also* Dust caps**
- Q**
- Quick Connect Series 107–112**
- R**
- Removal tools 140–143**
- Resistors 33–35**
- S**
- Sealing plugs 132**
- Seal ring**
  - Quick Connect Series 110
- Shrink boot adapter**
  - DT/DTM Series 23
- Specifications**
  - Material 7
- Performance**
  - Connectors 6
  - Contacts 122
- Standards 150**
- Strain relief**
  - DT Series 26
  - HD10 Series 76
  - HD30/HDP20 Series 85–86
  - IMC Series 116
  - Quick Connect Series 110–111
- STRIKE Series 99–106**
- T**
- Tooling**
  - Assembly 104, 142
  - Crimp tools
    - Automated 103, 137–138
    - Hand 103, 111, 117, 139–140
  - D hole punch 88
  - Insert/Removal tools 104, 111, 117, 140–143
- Tooling accessories 137–139**
- TPA (Terminal Position Assurance) 7, 29**
- “T” seal**
  - HD30/HDP20 Series 83
- W**
- Washers**
  - Quick Connect Series 110
- Wedgelocks**
  - DRB Series 70
  - DT/DTM/DTP Series 21–22
  - DTV Series 28
- Wire router**
  - DRB Series 68
  - DRC Series 65
- Wire sealing ranges 123–124**
- Wire seals**
  - Quick Connect Series 110
  - STRIKE Series 102
- WT Series 91–94**





### **Legal Notice**

The copyright for this material is reserved. To copy text or art from this document in any manner constitutes copyright infringement. Any duplication or use must have prior express written permission from Deutsch Industrial.

The information in this catalog is for reference purpose only. Precautions have been taken to assure accuracy of the information. Typographical or pictorial errors that are brought to our attention will be corrected in subsequent issues.

Product dimensions in this catalog are provided for the convenience of our customers. Deutsch reserves the right to make occasional product changes, without prior notification, which may change the dimensions shown. Please consult product drawings for exact specifications and to determine product fitness or suitability for individual design applications.





DEUTSCH

[www.deutsch.net](http://www.deutsch.net)

3850 Industrial Avenue, Hemet, CA 92545 • (951) 765-2250 • [insidesales-ipd@deutsch.net](mailto:insidesales-ipd@deutsch.net)  
Edition 2012

A STEP AHEAD