

Special-purpose Basic Switch DZ

DPDT Basic Switch for Two Independent Circuit Control

- Incorporates two completely independent built-in switches.
- Ideal for switching the circuits operating on two different voltages, and for controlling two independent circuits.
- Interchangeable with OMRON Z Basic Switches, as both switches are identical in mounting hole dimensions, mounting pitch and pin plunger position.



Ordering Information

Actuator		Terminal	Solder terminal (-1A)	Screw terminal (-B)
		OT (min.)	Model	Model
Pin plunger		0.13 mm	DZ-10G-1A	DZ-10G-1B
Hinge lever		1.6 mm	DZ-10GW-1A	DZ-10GW-1B
		0.4 mm	DZ-10GV-1A	DZ-10GV-1B
Short hinge roller lever		0.9 mm	DZ-10GW22-1A	DZ-10GW22-1B
		0.13 mm	DZ-10GV22-1A	DZ-10GV22-1B
Hinge roller lever		1.2 mm	DZ-10GW2-1A	DZ-10GW2-1B
		0.26 mm	DZ-10GV2-1A	DZ-10GV2-1B

Model Number Legend

DZ-10 G - 1
 1 2 3 4 5

1. Ratings

10: 10 A (250 VAC)

2. Contact Gap

G: 0.5 mm

3. Actuator

None: Pin plunger

Low OT Levers:

V: Hinge lever

V22: Short hinge roller lever

V2: Hinge roller lever

High OT Levers:

W: Hinge lever

W22: Short hinge roller lever

W2: Hinge roller lever

4. Contact Form

1: DPDT

5. Terminals

A: Solder terminal

B: Screw terminal

Specifications

■ Characteristics

Operating speed		0.1 mm to 1 m/s (See note 1)
Operating frequency	Mechanical	240 operations/min
	Electrical	20 operations/min
Contact resistance		15 mΩ max. (initial value)
Insulation resistance		100 MΩ min. (at 500 VDC)
Dielectric strength		1,000 VAC, 50/60 Hz for 1 min between non-continuous terminals 1,500 VAC, 50/60 Hz for 1 min between current-carrying metal parts and non-current-carrying metal part, and between current-carrying metal part and ground and between switches
Vibration resistance	Malfunction	10 to 55 Hz, 1.5-mm double amplitude (See note 2)
Shock resistance	Destruction	1,000 m/s ² max.
	Malfunction	300 m/s ² max. (See notes 1 and 2)
Degree of protection		IP00
Degree of protection against electric shock		Class I
Proof tracking index (PTI)		175
Ambient operating temperature		-25°C to 80°C (with no icing)
Ambient operating humidity		35% to 85%RH
Service life	Mechanical	1,000,000 operations min.
	Electrical	500,000 operations min.
Weight		Approx. 30 to 50 g

- Note:** 1. The values are for pin plunger models.
2. Malfunction: 1 ms max.

■ Ratings

Rated voltage (V)	Non-inductive load (A)				Inductive load (A)			
	Resistive load		Lamp load		Inductive load		Motor load	
	NC	NO	NC	NO	NC	NO	NC	NO
125 VAC	10		2	1	6		3	1.5
250 VAC	10		1.5	0.7	4		2	1
8 VDC	10		3	1.5	6		5	2.5
14 VDC	10		3	1.5	6		5	2.5
30 VDC	10		3	1.5	4		3	1.5
125 VDC	0.5		0.5		0.05		0.05	
250 VDC	0.25		0.25		0.03		0.03	

- Note:** 1. The above values are for steady-state current.
2. Inductive load has a power factor of 0.4 min. (AC) and a time constant of 7 ms max. (DC).
3. Lamp load has an inrush current of 10 times the steady-state current.
4. Motor load has an inrush current of 6 times the steady-state current.
5. The ratings values apply under the following test conditions:
(1) Ambient temperature: 20±2°C
(2) Ambient humidity: 65±5%RH
(3) Operating frequency: 20 operations/min

■ Contact Specifications

Contacts	Material	Silver alloy
	Gap (standard value)	0.5 mm
Inrush current	NC	30 A max.
	NO	15 A max.

■ Safety Standard Ratings

UL/CSA

Rated voltage	DZ-10G
125 VAC	10 A and 1/8 HP
250 VAC	10 A and 1/4 HP
480 VAC	2 A
125 VDC	0.5 A
250 VDC	0.25 A

Engineering Data

■ Mechanical Durability (DZ-10G-1B)

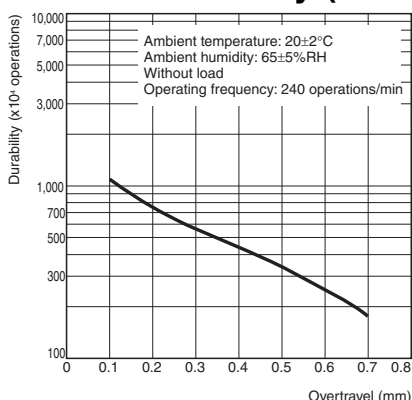

■ Electrical Durability (DZ-10G-1B)

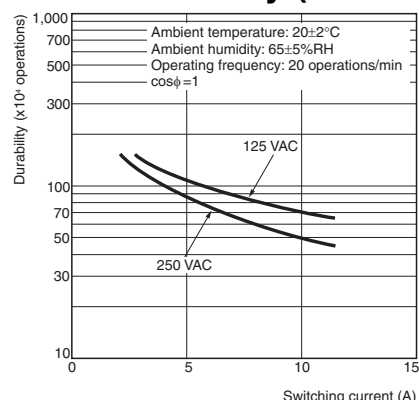

■ Structure

Contact Form (DPDT)

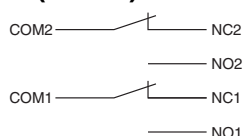

Dimensions

Note: Unless otherwise specified, all units are in millimeters and a tolerance of ± 0.4 mm applies to all dimensions.

■ Terminals

Screw Terminals (-1B)

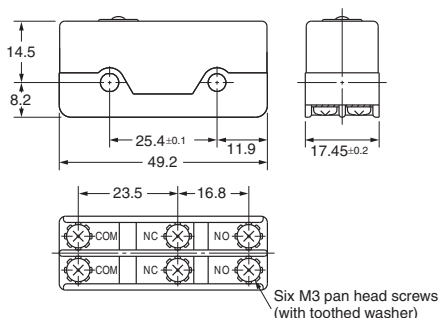

Solder Terminals (-1A)

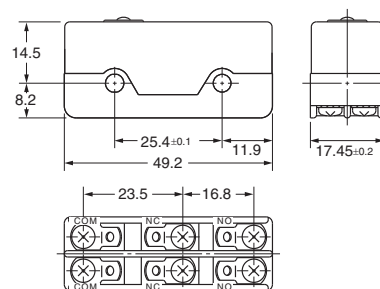

■ Mounting

All switches can be mounted using M4 mounting screws with plane washers or spring washers to securely mount the Switch. Tighten the screws to a torque of 1.18 to 1.47 N·m.

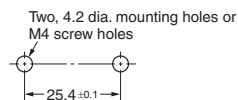

Accessories (Terminal Covers, and Separators): Refer to 'Z/A/X/DZ Common Accessories' datasheet

- Note: 1.** The solder terminal model has a suffix "-1A" in its model number and its omitted dimensions are the same as the corresponding dimensions of the pin plunger model.
- 2.** Unless otherwise specified, all units are in millimeters and a tolerance of ± 0.4 mm applies to all dimensions.

Pin Plunger
DZ-10G-1B

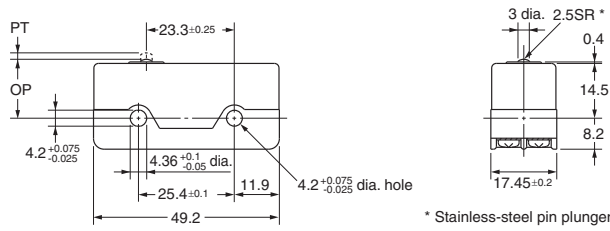

Operating force	OF max.	570 gf
Release force	RF min.	57 gf
Pretravel	PT max.	1.7 mm
Overtravel	OT min.	0.13 mm
Movement Differential	MD max.	0.4 mm
Operating Position	OP	15.6±0.4 mm

Hinge Lever
DZ-10GW-1B

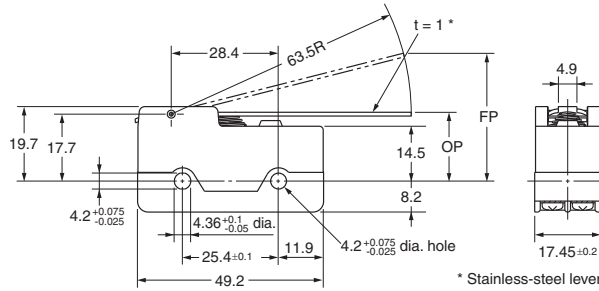
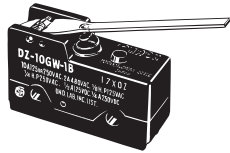

OF max.	170 gf
RF min.	28 gf
OT min.	1.6 mm
MD max.	4 mm
FP max.	46.3 mm
OP	21.8±1 mm

DZ-10GV-1B

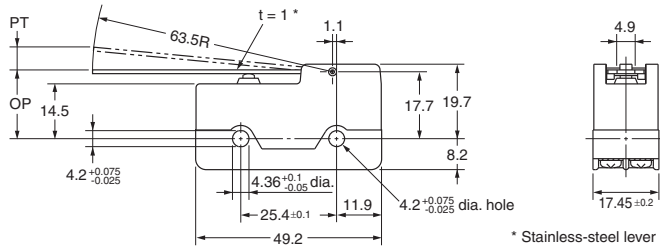
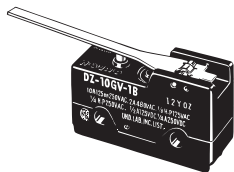

OF max.	200 gf
RF min.	13 gf
PT max.	6 mm
OT min.	0.4 mm
MD max.	1.7 mm
OP	18.3±1 mm

Short Hinge Roller Lever
DZ-10GW22-1B

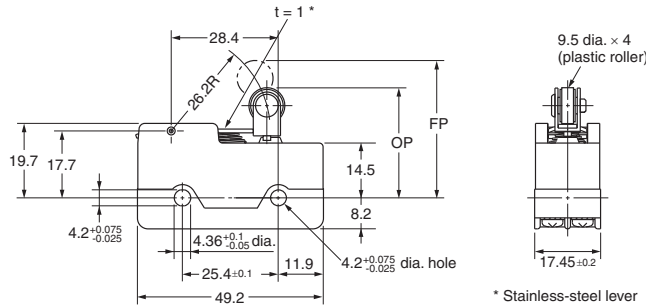

OF max.	400 gf
RF min.	85 gf
OT min.	0.9 mm
MD max.	2.4 mm
FP max.	39.7 mm
OP	30.2±0.8 mm

DZ-10GV22-1B

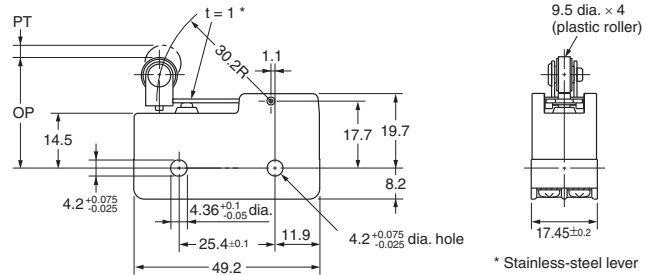

OF max.	430 gf
RF min.	42 gf
PT max.	3 mm
OT min.	0.13 mm
MD max.	0.6 mm
OP	29.4±0.8 mm

- Note:** 1. The solder terminal model has a suffix "-1A" in its model number and its omitted dimensions are the same as the corresponding dimensions of the pin plunger model.
 2. Unless otherwise specified, all units are in millimeters and a tolerance of ± 0.4 mm applies to all dimensions.

Hinge Roller Lever
DZ-10GW2-1B

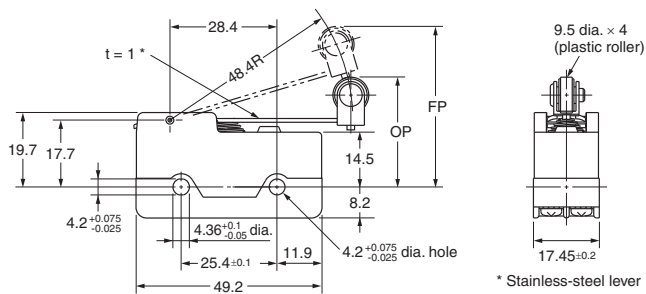
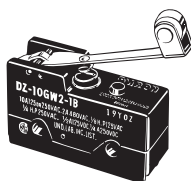

OF max.	213 gf
RF min.	42 gf
OT min.	1.2 mm
MD max.	3.3 mm
FP max.	47.6 mm
OP	31.8 \pm 0.8 mm

DZ-10GV2-1B

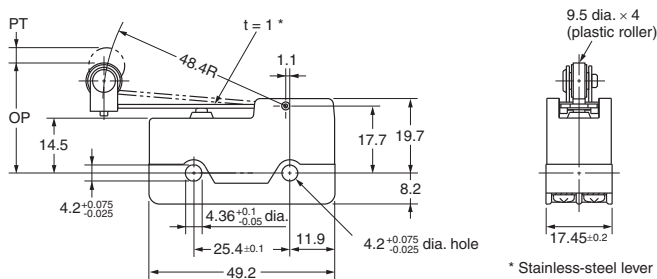
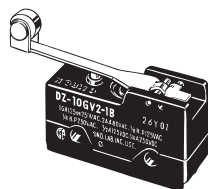

OF max.	270 gf
RF min.	34 gf
PT max.	4 mm
OT min.	0.26 mm
MD max.	1.1 mm
OP	29.4 \pm 0.8 mm

Safety Precautions

Be sure to read the precautions and information common to all Snap Action and Detection Switches, contained in the Technical User's Guide, "Snap Action Switches, Technical Information" for correct use.

Precautions for Safe Use

Terminal Connection

When soldering lead wires to the Switch, make sure that the capacity of the soldering iron is 60 W maximum. Do not take more than 5 s to solder any part of the Switch. The characteristics of the Switch will deteriorate if a soldering iron with a capacity of more than 60 W is applied to any part of the Switch for 5 s or more.

Operation

- Make sure that the switching frequency or speed is within the specified range.
1. If the switching speed is extremely slow, the contact may not be switched smoothly, which may result in a contact failure or contact welding.
 2. If the switching speed is extremely fast, switching shock may damage the Switch soon. If the switching frequency is too high, the contact may not catch up with the speed.
The rated permissible switching speed and frequency indicate the switching reliability of the Switch.
The life of a Switch is determined at the specified switching speed. The life varies with the switching speed and frequency even when they are within the permissible ranges. In order to determine the life of a Switch model to be applied to a particular use, it is best to conduct an appropriate durability test on some samples of the model under actual conditions.
- Make sure that the actuator travel does not exceed the permissible OT position. The operating stroke must be set to 70% to 100% of the rated OT.

- Do not use the switch in locations subject to hot water (greater than 60°C) or in water vapor.
- Do not use the switch outside the specified temperature and atmospheric conditions.
The permissible ambient temperature depends on the model. (Refer to the specifications in this catalog.) Sudden thermal changes may cause thermal shock to distort the switch and result in faults.

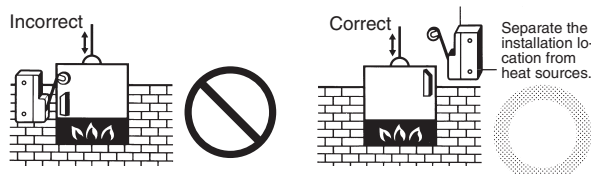

- Mount a cover if the switch is to be installed in a location where worker inattention could result in incorrect operation or accidents.



- Subjecting the switch to continuous vibration or shock may result in contact failure or faulty operation due to abrasion powder and in reduced durability. Excessive vibration or shock will cause the contacts to operate malfunction or become damaged. Mount the switch in a location that is not subject to vibration or shock and in a direction that does not subject the switch to resonance.
- If silver contacts are used with relatively low frequency for a long time or are used with microloads, the sulfide coating produced on the contact surface will not be broken down and contact faults will result. Use a microload switch that uses gold contacts.
- Do not use the switch in atmospheres with high humidity or heat or in harmful gases, such as sulfide gas (H₂S, SO₂), ammonia gas (NH₃), nitric acid gas (HNO₃), or chlorine gas (Cl₂). Doing so may impair functionality, such as with damage due to contacting faults or corrosion.
- The switch includes contacts. If the switch is used in an atmosphere with silicon gas, arc energy may cause silicon oxide (SiO₂) to accumulate on the contacts and result in contact failure. If there is silicon oil, silicon filling, silicon wiring, or other silicon products in the vicinity of the switch, use a contact protection circuit to limit arcing and remove the source of the silicon gas.

Precautions for Correct Use

Mounting Location

- Do not use the switch alone in atmospheres such as flammable or explosive gases. Arcing and heat generation associated with switching may cause fires or explosions.
- Switches are generally not constructed with resistance against water. Use a protective cover to prevent direct spraying if the switch is used in locations subject to splashing or spurting oil or water, dust adhering.

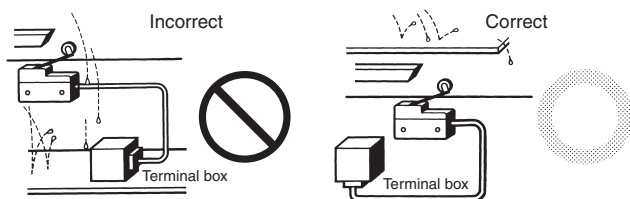

- Install the switch in a location that is not directly subject to debris and dust from cutting. The actuator and the switch body must be protected from accumulated cutting debris and dirt.

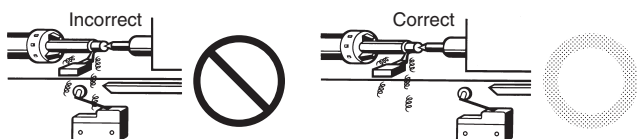

A large grid of graph paper for taking notes, consisting of 20 columns and 30 rows of small squares.

All sales are subject to Omron Electronic Components LLC standard terms and conditions of sale, which can be found at http://www.components.omron.com/components/web/webfiles.nsf/sales_terms.html

ALL DIMENSIONS SHOWN ARE IN MILLIMETERS.
To convert millimeters into inches, multiply by 0.03937. To convert grams into ounces, multiply by 0.03527.

OMRON[®]

**OMRON ELECTRONIC
COMPONENTS LLC**

55 E. Commerce Drive, Suite B
Schaumburg, IL 60173

847-882-2288

OMRON ON-LINE

Global - <http://www.omron.com>

USA - <http://www.components.omron.com>