

1.1

Counters, Panel Meters, Tachometers and Timers

Totalizers

1

ME Series

Product Description

Small in size and price, but large in design versatility and model variety is the ME Series of miniature electric counters. Models in most popular AC or DC voltages operate on as little as 3 watts, with the non-reset

models measuring only 1 x 1.593 x 2.187 in (25.4 x 40.5 x 55.5 mm) and weighing just three ounces (85 grams).

Available in 4, 6 or 7 figures, the counters feature stainless steel self-lubricating shafts, nylatron pinions and a synchronous electromagnetic drive to assure accurate,

reliable, long life operation. Designed for mounting flexibility and aesthetic attractiveness, the miniature electric counters are available with three types of mounting and a glare retarding finish Delrin, with crisp easy-to-read numerals set close to a tamper-proof sealed figure window.

Standards and Certifications

- UL recognized



Product Selection

When Ordering Specify

When ordering ME Series Miniature Electric Counters, specify catalog numbers according to the features selected.

Bottom Mount Wire Leads

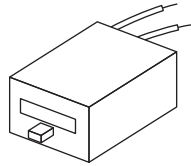

Base Mount Wire Leads

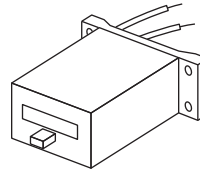

Panel Mount Wire Leads

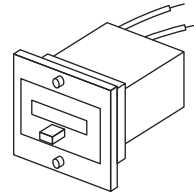

ME Series Miniature Electric Counter



ME Series Miniature Electric Counters

No. of Figures	Voltage	Reset	Mounting	Catalog Number	Order Number
4	12 Vdc	Pushbutton	Bottom	4-Y-41312-401-MEQ	41312401
4	24 Vdc	Pushbutton	Bottom	4-Y-41312-402-MEQ	41312402
4	120 Vac	Pushbutton	Bottom	4-Y-41312-406-MEQ	41312406
4	24 Vdc	Pushbutton	Base	4-Y-41313-402-MEQ	41313402
4	120 Vac	Pushbutton	Base	4-Y-41313-406-MEQ	41313406
4	240 Vac	Pushbutton	Base	4-Y-41313-407-MEQ	41313407
4	12 Vdc	Pushbutton	Panel	4-Y-41314-401-MEQ	41314401
4	24 Vdc	Pushbutton	Panel	4-Y-41314-402-MEQ	41314402
4	120 Vac	Pushbutton	Panel	4-Y-41314-406-MEQ	41314406
4	240 Vac	Pushbutton	Panel	4-Y-41314-407-MEQ	41314407

ME Series Miniature Electric Counter**ME Series Miniature Electric Counters, continued**

No. of Figures	Voltage	Reset	Mounting	Catalog Number	Order Number
6	24 Vdc	Non-reset	Bottom	6-Y-41119-402-ME	41119402
6	120 Vac	Non-reset	Bottom	6-Y-41119-406-ME	41119406
6	12 Vdc	Non-reset	Base	6-Y-41345-401-ME	41345401
6	24 Vdc	Non-reset	Base	6-Y-41345-402-ME	41345402
6	120 Vac	Non-reset	Base	6-Y-41345-406-ME	41345406
6	240 Vac	Non-reset	Base	6-Y-41345-407-ME	41345407
6	12 Vdc	Non-reset	Panel	6-Y-41346-401-ME	41346401
6	24 Vdc	Non-reset	Panel	6-Y-41346-402-ME	41346402
6	120 Vac	Non-reset	Panel	6-Y-41346-406-ME	41346406
6	240 Vac	Non-reset	Panel	6-Y-41346-407-ME	41346407
7	12 Vdc	Non-reset	Bottom	7-Y-41238-401-ME	41238401
7	24 Vdc	Non-reset	Bottom	7-Y-41238-402-ME	41238402
7	120 Vac	Non-reset	Bottom	7-Y-41238-406-ME	41238406
7	12 Vdc	Non-reset	Base	7-Y-41337-401-ME	41337401
7	24 Vdc	Non-reset	Base	7-Y-41337-402-ME	41337402
7	120 Vac	Non-reset	Base	7-Y-41337-406-ME	41337406
7	12 Vdc	Non-reset	Panel	7-Y-41349-401-ME	41349401
7	24 Vdc	Non-reset	Panel	7-Y-41349-402-ME	41349402
7	120 Vac	Non-reset	Panel	7-Y-41349-406-ME	41349406
7	240 Vac	Non-reset	Panel	7-Y-41349-407-ME	41349407

Technical Data and Specifications**General Specifications**

Description	Specification
Figures	4, 6 and 7
Speed	Up to 1000 cpm
Figure size	3/16 in (4.8 mm) high
Reset	Pushbutton and non-reset
Reset force	Pushbutton models only, 20 oz. (568 grams) maximum
Mounting	Base, bottom, panel
Finish	Black self-extinguishing plastic
Electrical connections	Wire leads, 10 in (254 mm) long, AWG 20, stripped 3/8 in (9.5 mm), and pin terminals
Power requirements	3W
Coils	Count coils are designed for continuous duty at rated voltage

1.1

Counters, Panel Meters, Tachometers and Timers

Totalizers

1

Dimensions

Approximate Dimensions in Inches (mm)

ME Series Counters

Panel Mounted

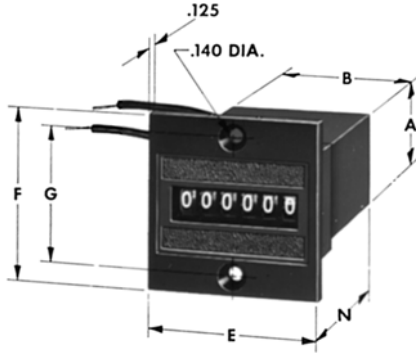

Bottom Mounted

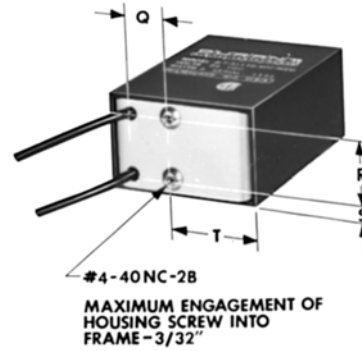

Base Mounted

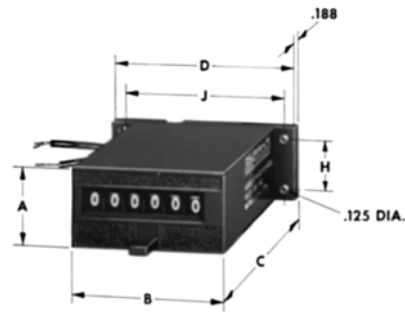

Bottom Mounted

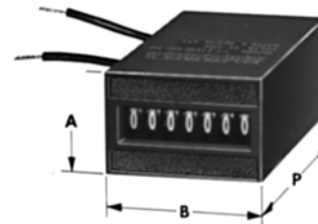

ME Series Counters

4 Figure Pushbutton Reset Counters

Dimension	Inches (mm)
A	1.00 (25.4)
B	1.60 (40.6)
C	2.64 (67.1)
D	2.19 (55.6)
E	1.80 (45.7)
F	1.80 (45.7)
G	1.40 (35.6)
H	0.69 (17.5)
J	1.88 (47.8)
K	0.50 (12.7)
L	0.49 (12.4)
M	0.94 (23.9)
N	2.45 (62.2)
P	2.45 (62.2)
Q	0.45 (11.4)
R	0.63 (16.0)
S	0.19 (4.8)
T	0.68 (17.3)

6 and 7 Figure Non-Reset Counters

Dimension	Inches (mm)
A	1.00 (25.4)
B	1.60 (40.6)
C	2.38 (60.5)
D	2.19 (55.6)
E	1.80 (45.7)
F	1.80 (45.7)
G	1.40 (35.6)
H	0.69 (17.5)
J	1.88 (47.8)
K	0.50 (12.7)
L	0.49 (12.4)
M	0.94 (23.9)
N	2.19 (55.6)
P	2.19 (55.6)
Q	0.45 (11.4)
R	0.63 (16.0)
S	0.19 (4.8)
T	0.88 (22.4)

Recommended Panel Mount Cut-Outs

4 Figure Counters Pushbutton Reset

1.72 x 1.11 (43.7 x 28.2)

6 and 7 Figure Counters Non-Reset

1.72 x 1.11 (43.7 x 28.2)