

Pegasus



Contact blocks

Spring loaded Terminals

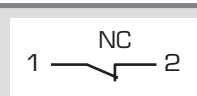

AUTOMATION TECHNOLOGIES

SPRING LOADED TERMINALS

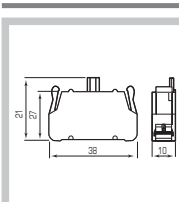
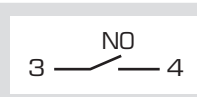
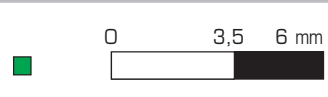
		CONTACT BLOCKS				
DESIGNATION	FUNCTIONS	CODE	DIMENSIONS			
			PCW01			
						

LAMPHOLDER BA9s

DESIGNATION	POWER SUPPLY	CODE	DIMENSIONS
	 <p>BA9s lamp socket 250V 2,4 w max bulb not included</p>	PCWAD	

LAMPHOLDER WITH BUILT-IN LED

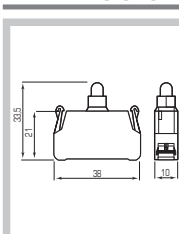
DESIGNATION	POWER SUPPLY	CODE	DIMENSIONS
	AC/DC 12V	PCW5L12	
	AC/DC 24V	PCW5L24	
	AC/DC 48V	PCW5L48	
	AC/DC 110V	PCW5L110	
	AC 220V	PCW5L220	

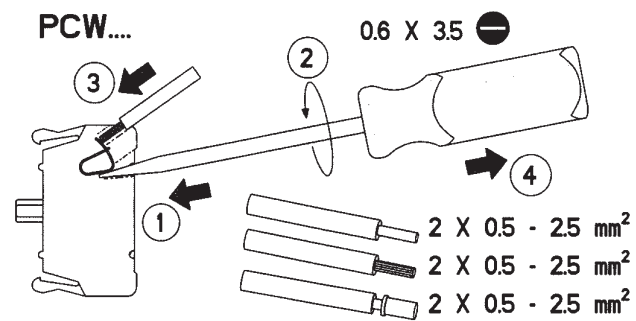
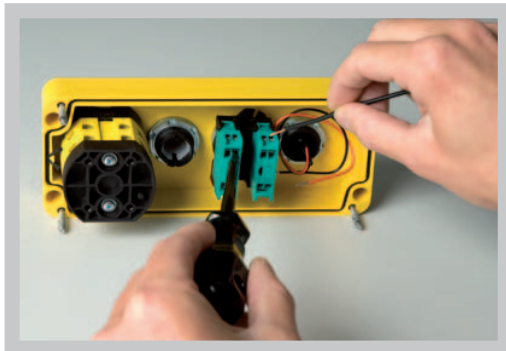





Pegasus

Contact blocks

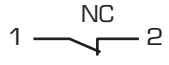
Welding terminals

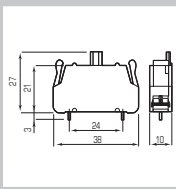
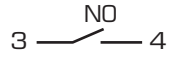
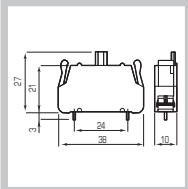
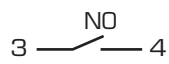
CONTACT BLOCKS

CONTACT BLOCKS				
DESIGNATION	FUNCTIONS	CODE	DIMENSIONS	
	NC 	  	PSC01	
	NO 	 	PSC10	

LAMPHOLDER BA9s

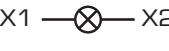
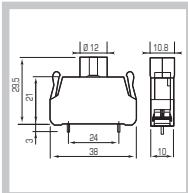
DESIGNATION	POWER SUPPLY	CODE	DIMENSIONS
	 <p>BA9s lamp socket 250V 2,4 w max bulb not included</p>	PSCAD	

LAMPHOLDER WITH BUILT-IN LED

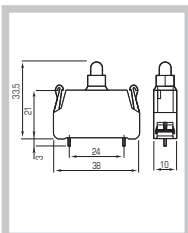
DESIGNATION	POWER SUPPLY	CODE	DIMENSIONS
	AC/DC 12V	PSC5L12	
	AC/DC 24V	PSC5L24	
	AC/DC 48V	PSC5L48	
	AC/DC 110V	PSC5L110	
	AC 220V	PSC5L220	

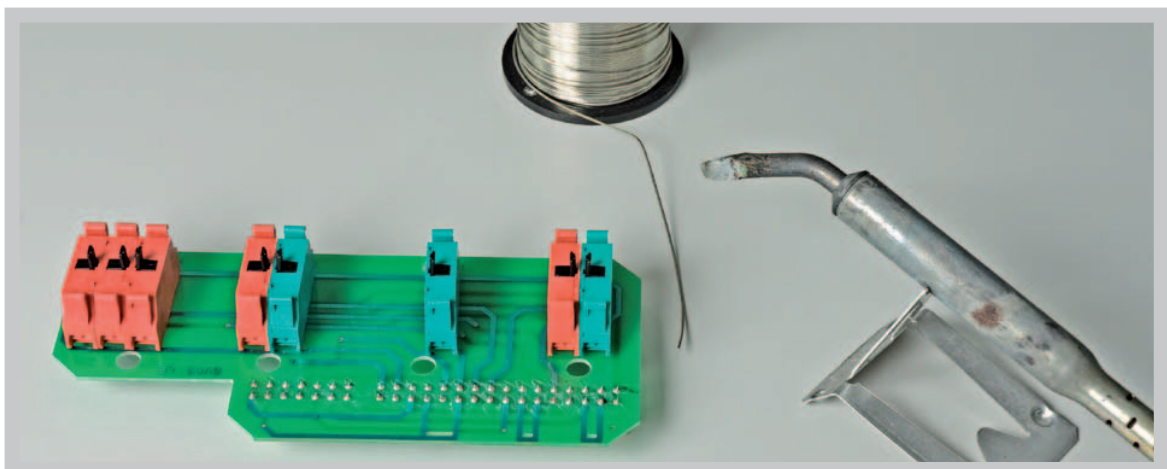

Pegasus

Contact blocks

Screw terminals



AUTOMATION TECHNOLOGIES

CONTACT BLOCKS

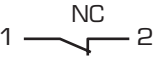
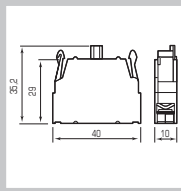
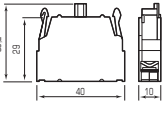
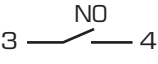
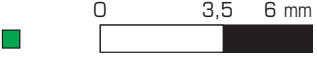
		CONTACT BLOCKS				
DESIGNATION	FUNCTIONS	CODE	DIMENSIONS			
			PL004001			
			PL004002			

LAMPHOLDER BA9s

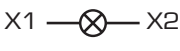
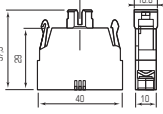
DESIGNATION	POWER SUPPLY	CODE	DIMENSIONS	
	 <p>BA9s lamp socket 250V 2,4 w max bulb not included</p>	PL004007		

LAMPHOLDER WITH BUILT-IN LED

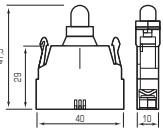
DESIGNATION	POWER SUPPLY	CODE	DIMENSIONS	
	AC/DC 12V	PL0045L12		
	AC/DC 24V	PL0045L24		
	AC/DC 48V	PL0045L48		
	AC/DC 110V	PL0045L110		
	AC 220V	PL0045L220		

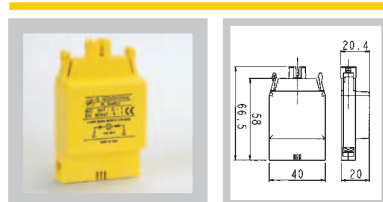

POWER SUPPLY WITH DIODE AND RESISTORS

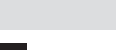

DESIGNATION	POWER SUPPLY	CODE
1 BA9s 	110/130V Lamp 4B/60V -2W max	PL004RD1
	220/240V Lamp 110/130V -2W max	PL004RD2

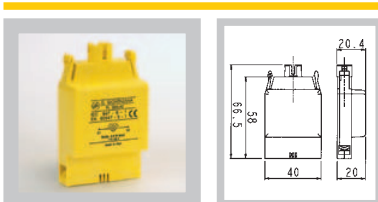

POWER SUPPLY WITH TRANSFORMER

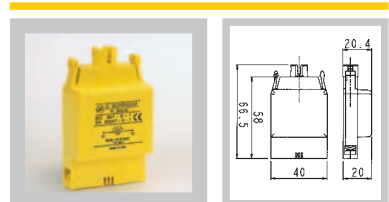

DESIGNATION	POWER SUPPLY	CODE
1 BA9s 	Input 110/130V Output 24V	PL004TR1
	Input 220/240V Output 24V	PL004TR2
	Input 380/440V Output 24V	PL004TR3

POWER SUPPLY WITH FLASHING LIGHT



DESIGNATION	POWER SUPPLY	CODE
1 BA9s 	24V Lamp 24V-2,6 max	PL004LA1
	110/130V 110/130V-2,6 max	PL004LA2

1 Lamp supply separately