

# Solid State Relays 1-Phase Integrated Heatsink Zero Cross or Instant On Switching Types RGC Solid State Contactor 'U' Connection



- Product Width ranging from 17.5mm up to 70mm
- Rated Operational voltage: Up to 600VAC
- Rated Operational current: Up to 85AAC @ 40°C
- Up to 18000A<sup>2</sup>s for I<sup>2</sup>t and 1200Vp blocking voltage
- Control voltages: 3-32 VDC, 20-275 VAC (24-190 VDC)
- IP20 protection
- Design according to EN/IEC60947-4-2, EN/IEC60947-4-3, EN/IEC62314, UL508, CSA 22-2 No. 14-10
- Integrated voltage transient protection with varistor
- RoHS compliant
- Short circuit current rating: 100kA
- VDE approval
- Germanischer Lloyd approval<sup>1</sup>

## Product Description

This new range of solid state contactors presents a unique opportunity to maximize efficiency in panel space and is an evolution of solid state switches for which Carlo Gavazzi is very well known.

The nominal current ratings are at 40°C. The smallest width is 17.5mm and is rated at 20 AAC. Power and control terminals allow for safe looping of cables.

Voltage transient protection is standard across the output with a varistor. Specifications are stated at 25°C unless otherwise noted.

1. Germanischer Lloyd approval applicable only to models RGC...15KGU, RGC...20KGU, RGC...25KGU and RGC...30KGU

## Ordering Key **RGC 1 A 60 A 40 K G U**

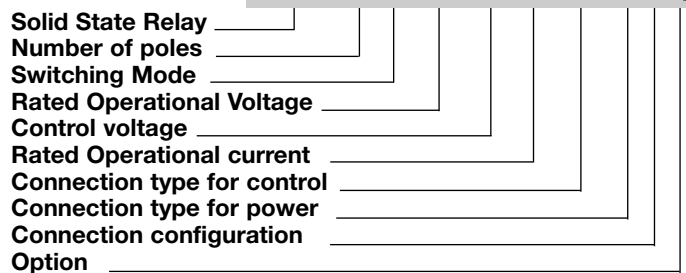

## Ordering Key (Refer to page 2 for available part numbers)

1Phase SSR with heatsink	Rated Voltage, Blocking Voltage	Control Voltage	Rated Current at 40°C <sup>2</sup>	Connection Control	Connection Power	Connection Configuration	Option
<b>RGC1A: ZC<sup>4</sup></b>	23: 230V +10% - 15%, 800Vp	D: 3 or 4-32VDC	15: 20AAC, 525A <sup>2</sup> s	K: Screw	G: Box Clamp	U: SSR	P: Overtemperature protection (OTP) <sup>3</sup>
<b>RGC1B: IO<sup>4</sup></b>	60: 600V +10% -15%, 1200Vp	A: 20 - 275VAC, 24-190 VDC	20: 23AAC, 525A <sup>2</sup> s 25: 25AAC, 1800A <sup>2</sup> s 30: 30AAC, 1800A <sup>2</sup> s 40: 40AAC, 3200A <sup>2</sup> s 42: 43AAC, 1800A <sup>2</sup> s 60: 60AAC, 3200A <sup>2</sup> s 62: 65AAC, 1800A <sup>2</sup> s 90: 85AAC, 6600A <sup>2</sup> s	G: Box clamp			

2. Refer to derating curves

3. Default control connection for RGC...P is Box Clamp. See connections specifications.

4: ZC = Zero Cross switching, IO = Instant On switching

## Selection Guide

Rated voltage, Blocking voltage, Switching mode	Control voltage	Connection Control/ Power	Rated operational current @ 40°C (I <sup>2</sup> t value)			
			Product width			
			20 AAC (525A <sup>2</sup> s) 17.5mm, low depth	23 AAC (525A <sup>2</sup> s) 17.5mm	25 AAC (1800A <sup>2</sup> s) 17.5mm, low depth	30 AAC (1800A <sup>2</sup> s) 22.5mm
230V, 800Vp ZC	3-32VDC	Screw/Box	RGC1A23D15KGU	RGC1A23D20KGU	RGC1A23D25KGU	RGC1A23D30KGU
	20-275VAC, 24-190VDC	Screw/Box	RGC1A23A15KGU	RGC1A23A20KGU	RGC1A23A25KGU	RGC1A23A30KGU
			40 AAC (3200A <sup>2</sup> s) 35mm	43 AAC (18000A <sup>2</sup> s) 35mm	60 AAC (3200A <sup>2</sup> s) 70mm	65 AAC (18000A <sup>2</sup> s) 70mm
	3-32VDC	Screw/Box	RGC1A23D40KGU	RGC1A23D42KGU	RGC1A23D60KGU	RGC1A23D62KGU
	20-275VAC, 24-190VDC	Screw/Box	RGC1A23A40KGU	RGC1A23A42KGU	RGC1A23A60KGU	RGC1A23A62KGU
			20 AAC (525A <sup>2</sup> s) 17.5mm, low depth	23 AAC (525A <sup>2</sup> s) 17.5mm	25 AAC (1800A <sup>2</sup> s) 17.5mm, low depth	30 AAC (1800A <sup>2</sup> s) 22.5mm
600V,1200Vp ZC	4-32VDC	Screw/Box	RGC1A60D15KGU	RGC1A60D20KGU	RGC1A60D25KGU	RGC1A60D30KGU
	20-275VAC, 24-190VDC	Screw/Box	RGC1A60A15KGU	RGC1A60A20KGU	RGC1A60A25KGU	RGC1A60A30KGU
			40 AAC (3200A <sup>2</sup> s) 35mm	43 AAC (18000A <sup>2</sup> s) 35mm	60 AAC (3200A <sup>2</sup> s) 70mm	65 AAC (18000A <sup>2</sup> s) 70mm
	4-32VDC	Screw/Box	RGC1A60D40KGU	RGC1A60D42KGU	RGC1A60D60KGU	RGC1A60D62KGU
	20-275VAC, 24-190VDC	Screw/Box	RGC1A60A40KGU	RGC1A60A42KGU	RGC1A60A60KGU	RGC1A60A62KGU
			20 AAC (525A <sup>2</sup> s) 17.5mm, low depth	23 AAC (525A <sup>2</sup> s) 17.5mm	25 AAC (1800A <sup>2</sup> s) 17.5mm, low depth	30 AAC (1800A <sup>2</sup> s) 22.5mm
600V, 1200Vp IO	4-32VDC	Screw/Box	RGC1B60D15KGU	RGC1B60D20KGU	RGC1B60D25KGU	RGC1B60D30KGU
			40 AAC (3200A <sup>2</sup> s) 35mm	43 AAC (18000A <sup>2</sup> s) 35mm	60 AAC (3200A <sup>2</sup> s) 70mm	65 AAC (18000A <sup>2</sup> s) 70mm
	4-32VDC	Screw/Box	RGC1B60D40KGU	RGC1B60D42KGU	RGC1B60D60KGU	RGC1B60D62KGU

## Selection Guide - RGC..P (Integrated Overtemperature Protection)

Rated voltage, Blocking voltage, Switching mode	Control voltage	Connection Control/ Power	Rated operational current @ 40°C (I <sup>2</sup> t value)		
			Product width		
			85AAC (6600A <sup>2</sup> s) 70mm + fan		
230V, 800Vp ZC	5-32VDC	Box/Box	RGC1A23D90GGUP		
			40 AAC (3200A <sup>2</sup> s) 35mm	60 AAC (3200A <sup>2</sup> s) 70mm	85 AAC (3200A <sup>2</sup> s) 70mm + fan
600V, 1200Vp ZC	5-32VDC	Box/Box	RGC1A60D40GGUP	RGC1A60D60GGUP	RGC1A60D90GGUP
	20-275VAC, 24-190VDC	Box/Box	RGC1A60A40GGUP	RGC1A60A60GGUP	RGC1A60A90GGUP
			85AAC (6600A <sup>2</sup> s) 70mm + fan		
600V, 1200Vp IO	5-32VDC	Box/Box	RGC1B60D90GGUP		

## Output Voltage Specifications

	RGC..23..	RGC..60..
Operational Voltage Range	24-240 VAC, +10%, -15% on max	42-600 VAC, +10% -15% on max
Blocking Voltage	800Vp	1200 Vp
Internal Varistor	275V	625V

## General Specifications

Latching voltage (across L1-T1)	≤20V	Over-voltage category	III (fixed installations)
Operational frequency range	45 to 65Hz	Isolation	
Power factor	> 0.5 @ Vrated	Input to Output RGC...	4000 Vrms
Touch Protection	IP20	RGC...D..P	2500 Vrms
Control input status	continuously ON Green LED, when control input is applied	RGC...A..P	4000 Vrms
Pollution degree	2 (non-conductive pollution with possibilities of condensation)	Input and Output RGC... to case RGC...D..P RGC...A..P	4000 Vrms 4000 Vrms 4000 Vrms
		Input to Fan/ Alarm Output RGC...A..P	2500 Vrms

## Output Specifications

	RGC..15..	RGC..20..	RGC..25..	RGC..30..
Rated operational current <sup>6</sup> AC-51 rating @ Ta=25°C	20 AAC	25.5 AAC	30 AAC	30 AAC
AC-51 rating @ Ta=40°C	20 AAC	23 AAC	25 AAC	30 AAC
AC-53a rating @ Ta=40°C	5 AAC	5 AAC	5 AAC	8 AAC
Number of motor starts (x:6, Tx:6s, F:50%) at 40°C <sup>5</sup>	30	30	30	30
Min. operational current	150 mAAC	150 mAAC	250 mAAC	250 mAAC
Rep. overload current - (Motor Rating) PF = 0.4 - 0.5 UL508: T <sub>AMB</sub> =40°C, t <sub>ON</sub> =1s, t <sub>OFF</sub> =9s, 50cycles	51 AAC	60 AAC	51 AAC	84 AAC
Maximum transient surge current (I <sub>TSM</sub> ), t=10ms	325 Ap	325 Ap	600 Ap	600Ap
Maximum off-state leakage current at rated voltage	3 mAAC	3 mAAC	3 mAAC	3 mAAC
I <sup>2</sup> t for fusing (t=10ms) Minimum	525 A <sup>2</sup> s	525 A <sup>2</sup> s	1800 A <sup>2</sup> s	1800 A <sup>2</sup> s
Critical dv/dt (@ T <sub>j</sub> init = 40°C)	1000 V/us	1000 V/us	1000 V/us	1000 V/us

	RGC..40..	RGC..42..	RGC..60..	RGC..62..	RGC..90..
Rated operational current <sup>6</sup> AC-51 rating @ Ta=25°C	47 AAC	50 AAC	70 AAC	75 AAC	85 AAC
AC-51 rating @ Ta=40°C	40 AAC	43 AAC	60 AAC	65 AAC	85 AAC
AC-53a rating @ Ta=40°C	13 AAC	16 AAC	14.8 AAC	20 AAC	18 AAC
Number of motor starts (x:6, Tx:6s, F:50%) at 40°C <sup>5</sup>	30	30	30	30	30
Min. operational current	400 mAAC	500 mAAC	400 mAAC	500 mAAC	400 mAAC
Rep. overload current - (Motor Rating) PF = 0.4 - 0.5 UL508: T <sub>AMB</sub> =40°C, t <sub>ON</sub> =1s, t <sub>OFF</sub> =9s, 50cycles	126 AAC	126 AAC	144 AAC	168 AAC	168 AAC
Maximum transient surge current (I <sub>TSM</sub> ), t=10ms	800 Ap	1900 Ap	800 Ap	1900 Ap	1150 Ap
Maximum off-state leakage current at rated voltage	3 mAAC	3 mAAC	3 mAAC	3 mAAC	3 mAAC
I <sup>2</sup> t for fusing (t=10ms) Minimum	3200 A <sup>2</sup> s	18000 A <sup>2</sup> s	3200 A <sup>2</sup> s	18000 A <sup>2</sup> s	6600 A <sup>2</sup> s
Critical dv/dt (@ T <sub>j</sub> init = 40°C)	1000 V/us	1000 V/us	1000 V/us	1000 V/us	1000 V/us

5. Overload current profile definition, x: multiple of AC53a rating, Tx: duration of current surge, F: duty cycle

6: refer to Derating Curves

## Overtemperature Alarm Specifications for RGC...P

	RGC..D..P	RGC..A..P
Output type	PNP open collector	Potential Free
Normal state	Closed	Closed
Maximum current rating	50 mADC	50 mADC
Rated voltage (EN61131-2: 2003) <sup>7,8</sup> , U <sub>a</sub>	24VDC -15%, +20%	24VDC -15%, +20%
Rated voltage, U <sub>s</sub>	RGC...D90GGUP 24VDC ± 10%	N/A
Fan rating, U <sub>f</sub>	RGC...A90GGUP N/A	24VDC ±10%, 50mA nominal
Alarm voltage drop	Typical Maximum 2.8VDC 4VDC	1.8VDC 3.5VDC
Visual Indication	Continuous Red LED	Continuous Red LED
Reverse polarity protection	24VDC	24VDC

7: DC supply for alarm signal should be supplied from a Class 2 power source

8: Maximum voltage to be applied between 11+ and 12- (U<sub>a</sub>) terminals should be 35VDC maximum with reference to A2-

## Input specifications

		RGC..D..	RGC..A..
Control voltage range <sup>9,10</sup>	RGC..23..	3 - 32 VDC	20 - 275 VAC, 24 (-10%) - 190 VDC
	RGC..60..	4 - 32 VDC	20-275 VAC, 24 (-10%) - 190 VDC
	RGC...P (Uc)	5 - 32 VDC	20-275 VAC, 24 (-10%) - 190 VDC
Pick-up voltage	RGC..23..	3.0 VDC	20 VAC/DC
	RGC..60..	3.8 VDC	
	RGC...P	5 VDC	20 VAC/ 24VDC
Drop-out voltage		1 VDC	5 VAC/DC
Maximum Reverse voltage		32 VDC	-
Response time pick-up ZC (RGC1A..)		0.5 cycle + 500µs @ 24VDC	2 cycles @ 230VAC/110VDC
Response time pick-up IO (RGC1B..)		350µs @ 24 VDC	N/A
Response time drop-out		0.5 cycle + 500µs @ 24VDC	0.5 cycle + 40ms @ 230VAC/ 110VDC
Input current @ 40°C		See diagrams below	See diagrams below

9. DC control to be supplied by class 2 power source according to UL1310

10. For GL approved models control range for RGC1.23... is 4-32VDC and for RGC1.60... 5-32VDC

### RG..A..

RGC1 .. A : input current vs input voltage

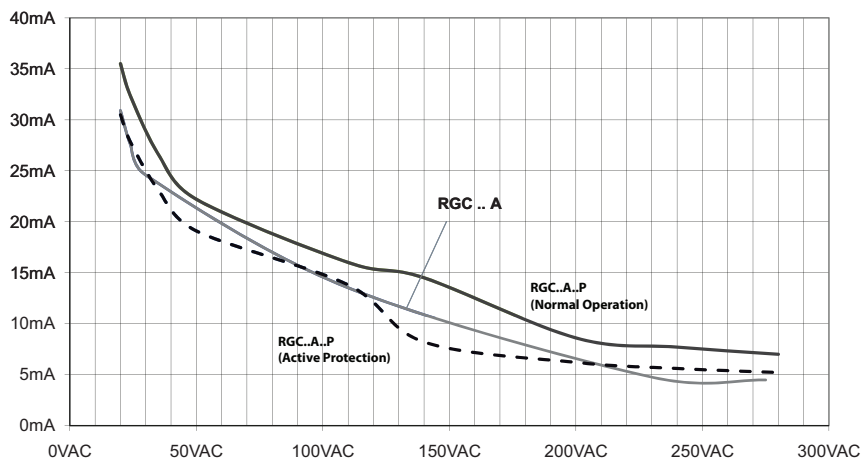

RGC1 .. A : input current vs input voltage

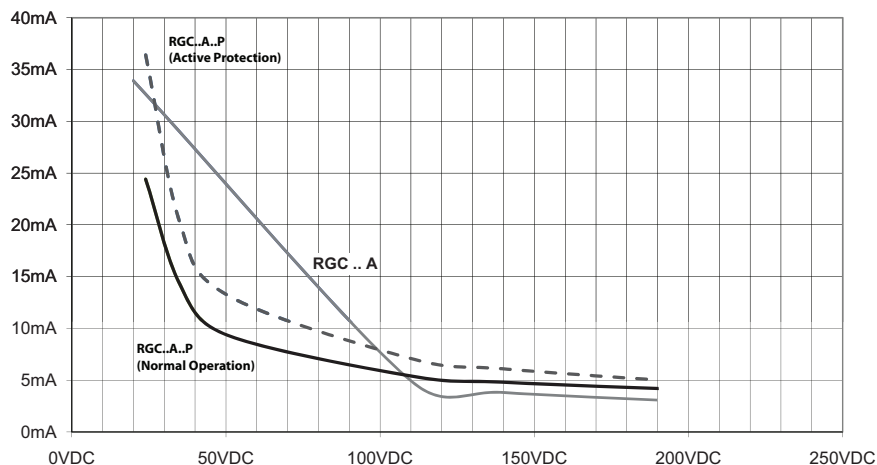

## Input specifications (cont.)

### RG..D..

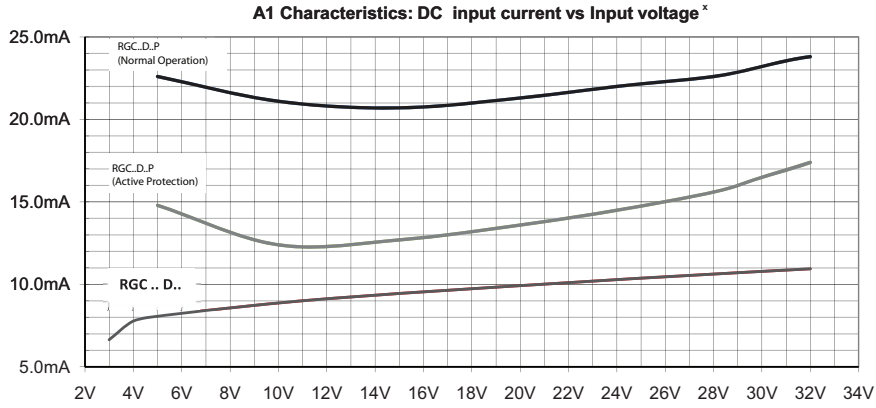

x: Input currents for RGC1..D15, RGC1..D20, RGC1..D25, RGC1..D30, RGC1..D4x, RGC1..D6x

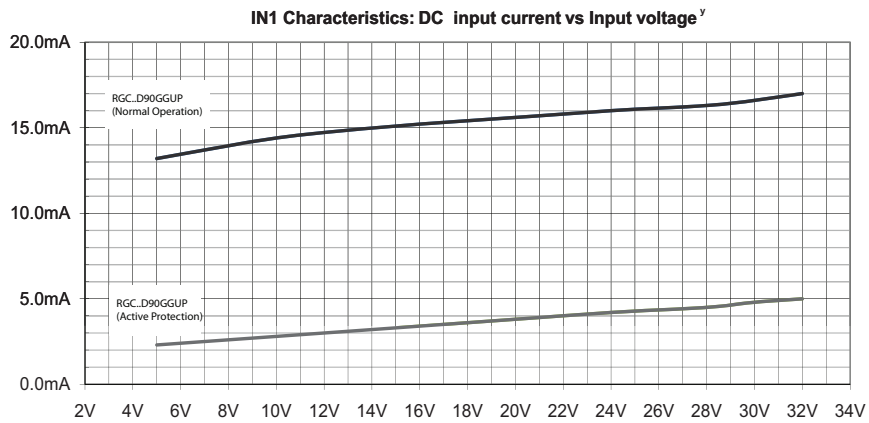

y: input currents valid only for RGC1..D90GGUP

**Motor Ratings: HP (UL508) / kW (EN/IEC60947-4-2) @ 40°C**

	115 VAC	230 VAC	400 VAC	480 VAC	600 VAC
RGC..15	1/3HP / 0.18kW	1HP / 0.37kW	2HP / 0.75kW	3HP / 1.1kW	3HP / 1.5kW
RGC..20	1/2HP / 0.18kW	1 1/2HP / 0.37kW	2HP / 0.75kW	3HP / 1.1kW	3HP / 1.5kW
RGC..25	1/3HP / 0.18kW	1HP / 0.37kW	2HP / 0.75kW	3HP / 1.1kW	3HP / 1.5kW
RGC..30	3/4HP / 0.37kW	2HP / 1.1kW	3HP / 1.5kW	5HP / 2.2kW	5HP / 3.7kW
RGC..40	1HP / 0.56kW	3HP / 1.5kW	5HP / 2.2kW	5HP / 3.7kW	7 1/2HP / 4kW
RGC..42	1 1/2HP / 0.56kW	3HP / 1.5kW	5HP / 2.2kW	7 1/2HP / 3.7kW	10HP / 4kW
RGC..60	1 1/2HP / 0.56kW	3HP / 1.5kW	5HP / 3kW	7 1/2HP / 4kW	10HP / 4kW
RGC..62	2HP / 0.75kW	5HP / 1.5kW	7 1/2HP / 4kW	10HP / 4kW	15HP / 5.5kW
RGC..90	2HP / 0.75kW	5HP / 1.5kW	7 1/2HP / 4kW	10HP / 4kW	15HP / 5.5kW

**Detailed Over temperature Alarm Procedure (for RGC...P)**

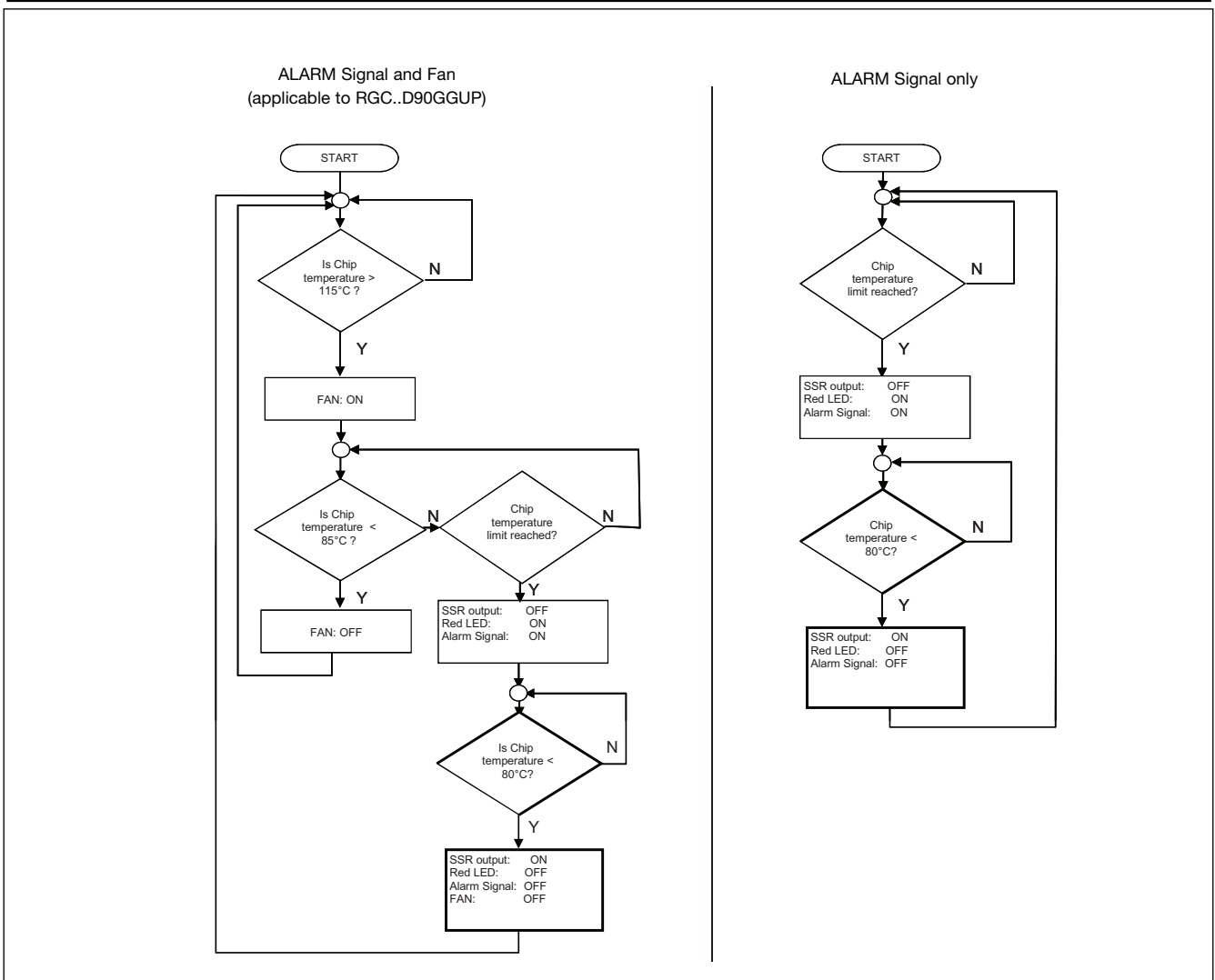

**CAUTION**

- Alarm condition resets whenever the voltage signal is removed from terminal A1 (+)
- In the case of RGC...D90GGUP, if the voltage signal is not applied across A1(+) and A2 (-) terminals, the overtemperature detection and functionality is lost (including fan operation and alarm signalling)
- In the case of RGC1A60A90GGUP it is necessary to supply IN2 and IN3 with 24VDC for fan operation.
- Alarm procedure for RGC1A60A90GGUP follows 'Alarm signal only' flow since fan is continuously operating.
- Alarm condition automatically resets ONLY when power semiconductor temperature < 80°C
- Temperatures indicated are typical figures.

## Output Power Dissipation

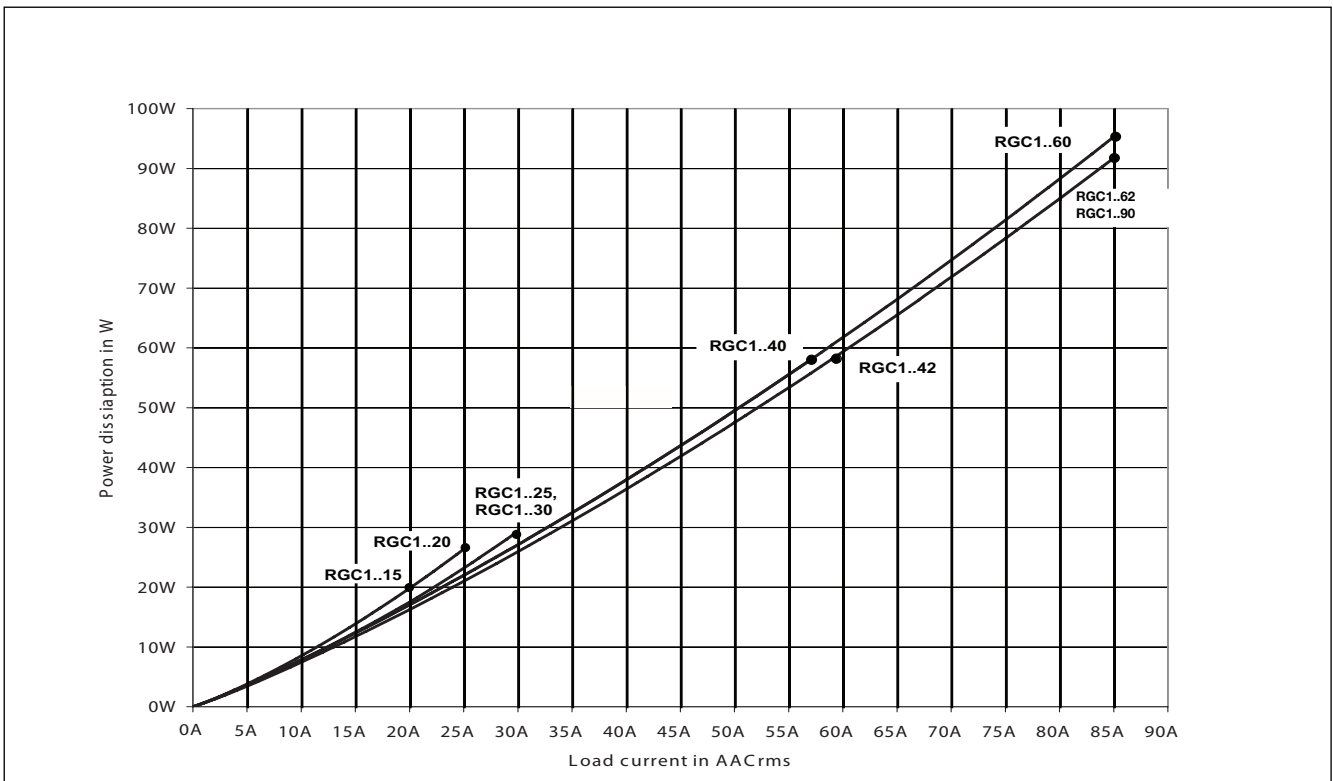

## Current Derating (UL508)

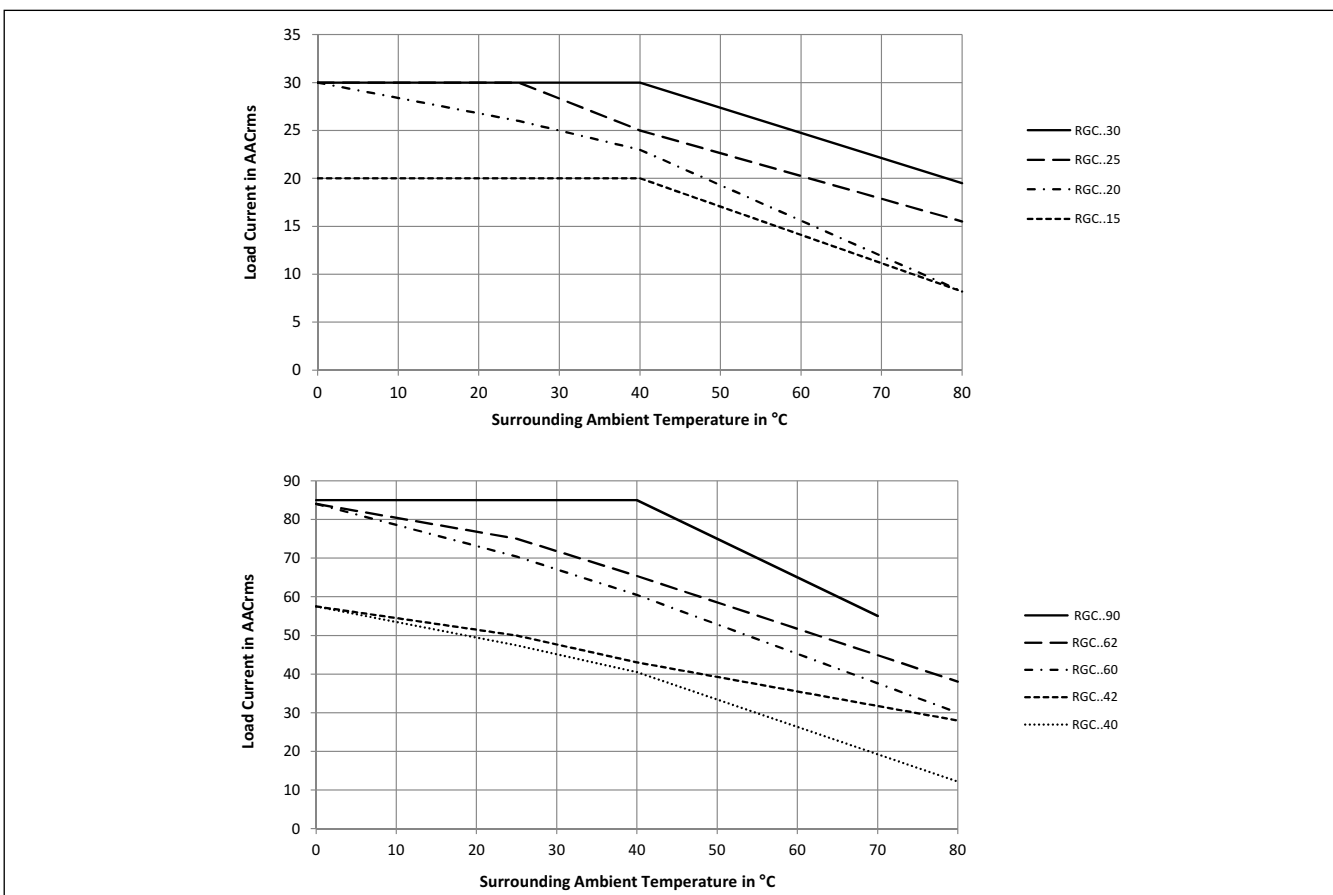

RGC...P models max. operating temperature is + 70°C



## Derating vs. Spacing Curves

RGC.. 15..

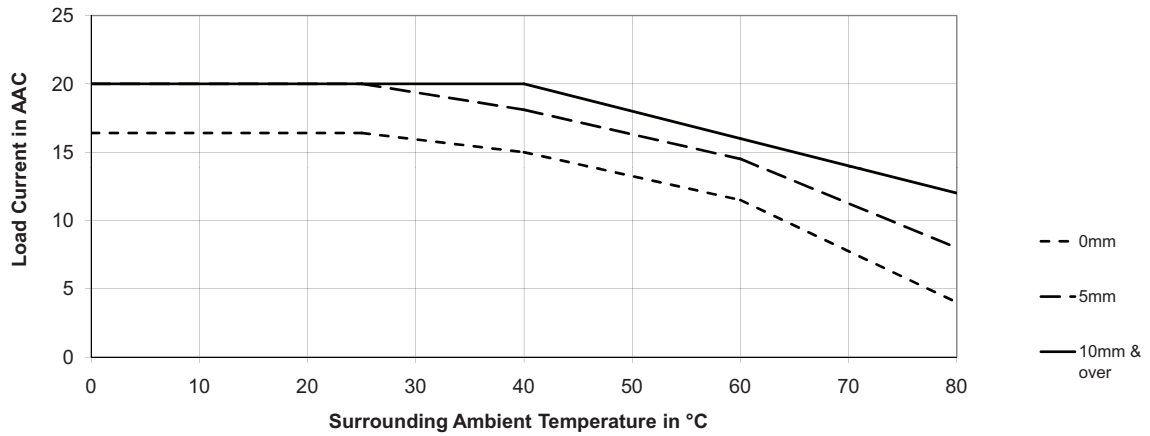

RGC.. 20..

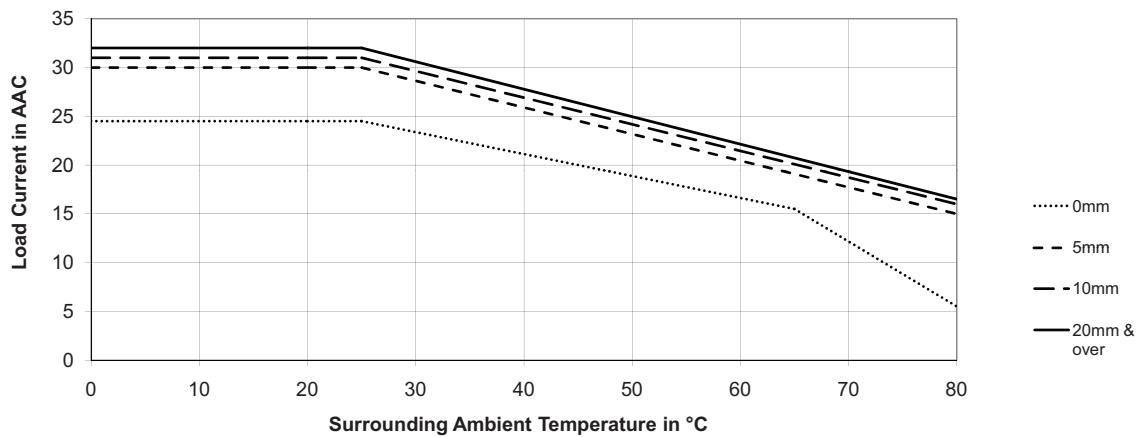

RGC.. 25..

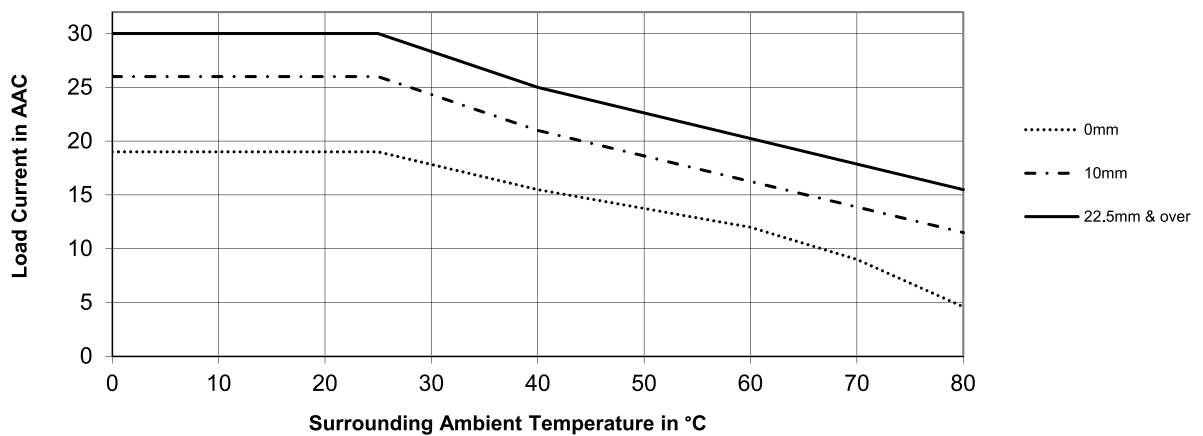

## Derating vs. Spacing Curves (cont.)

RGC.. 30..

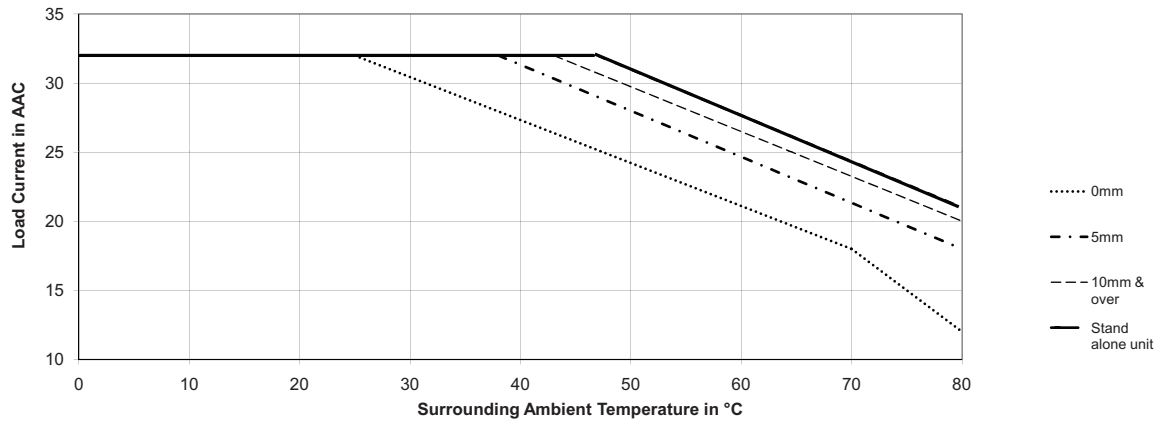

RGC.. 40..

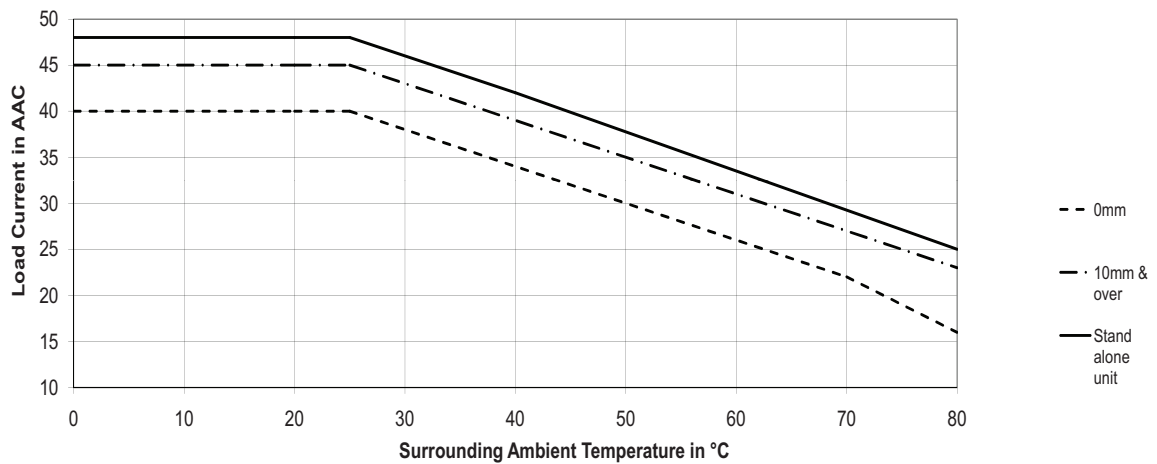

RGC.. 42..

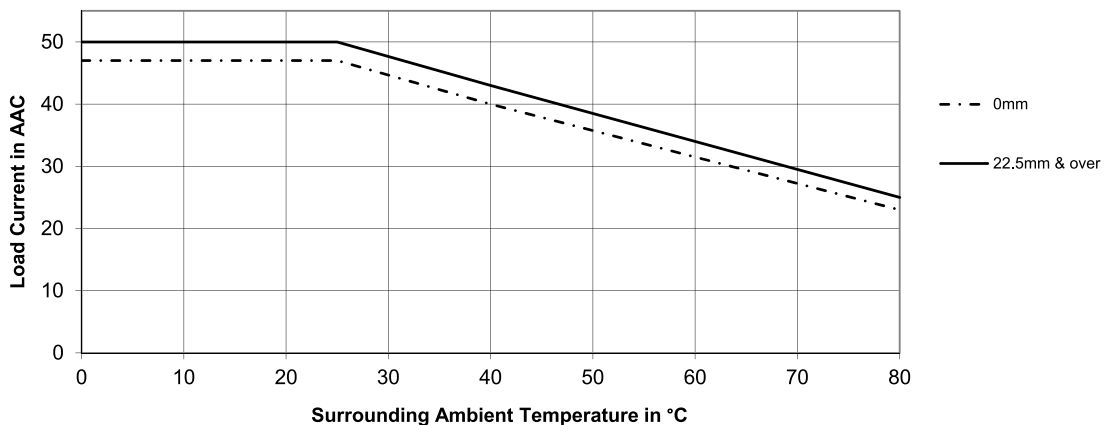

## Derating vs. Spacing Curves (cont.)

RGC.. 60..

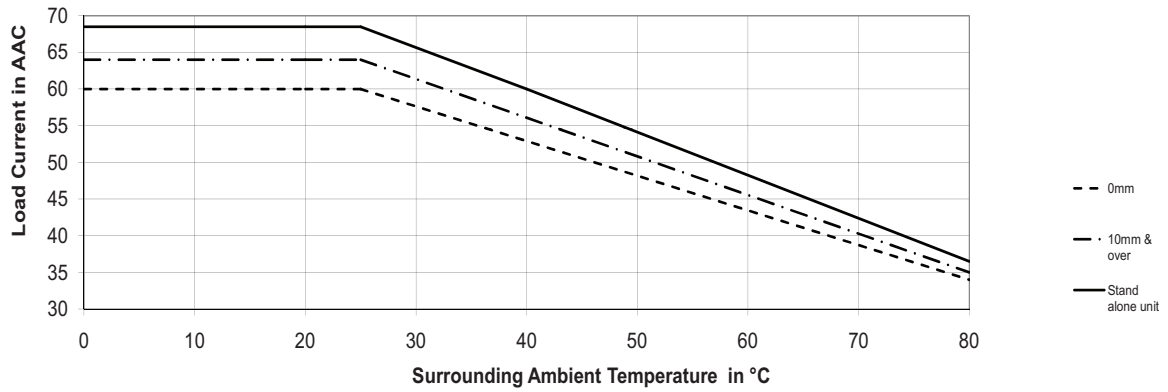

RGC.. 62..

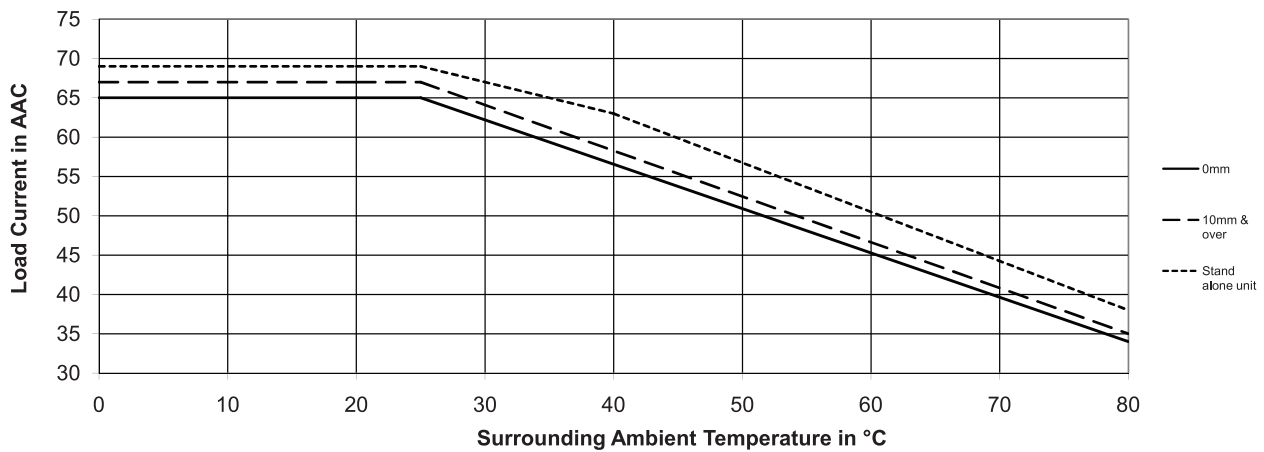

RGC.. 90GGUP

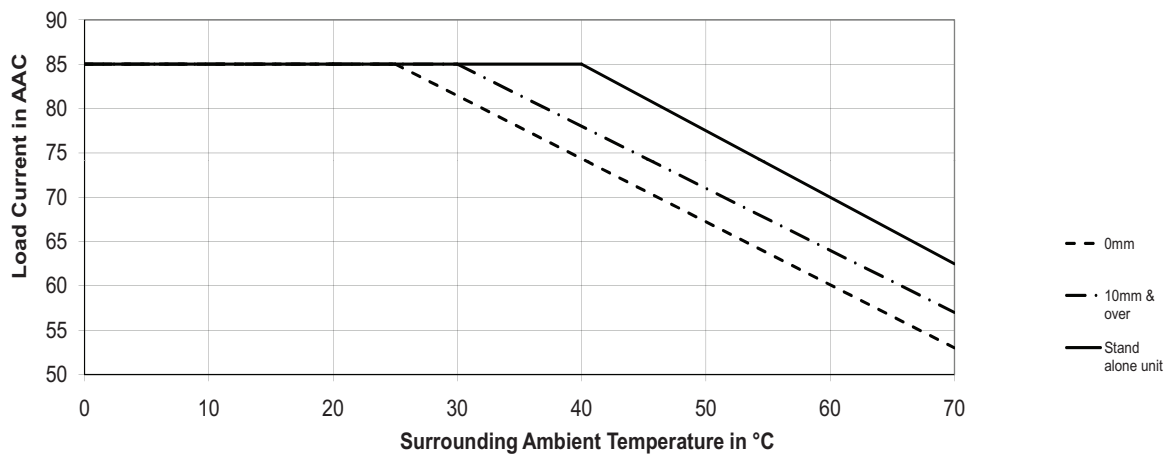

## Agency Approvals and Conformances

<b>Conformance</b>	IEC/EN 62314 IEC/EN 60947-4-2 IEC/EN 60947-4-3	<b>Agency Approvals</b>	UL508 Listed (E172877) cUL Listed (E172877) VDE (0660-109) GL <sup>12</sup>
		<b>Short Circuit Current Rating</b>	100kA, UL508



## Electromagnetic Compatibility

<b>EMC Immunity</b>	IEC/EN 61000-6-2	<b>Electrical Surge Immunity</b> (for RGC...UP)	IEC/EN 61000-4-5
<b>Electrostatic Discharge (ESD) Immunity</b>	IEC/EN 61000-4-2	Output, line to line, 1kV	Performance Criteria 1
Air discharge, 8kV	Performance Criteria 1	Output, line to earth, 2kV	Performance Criteria 1
Contact, 4kV	Performance Criteria 1	DC lines, line to line, 500V	Performance Criteria 2
<b>Electrical Fast Transient (Burst) Immunity</b>	IEC/EN 61000-4-4	DC lines, line to earth, 500V	Performance Criteria 2
Output: 2kV, 5kHz	Performance Criteria 1	Signal lines, line to earth, 1kV	Performance Criteria 2
Input: 1kV, 5kHz	Performance Criteria 1	<b>Radiated Radio Frequency Immunity</b>	IEC/EN 61000-4-3
<b>Electrical Surge Immunity</b> (for RGC...U)	IEC/EN 61000-4-5	10V/m, 80 - 1000 MHz	Performance Criteria 1
Output, line to line, 1kV	Performance Criteria 1	10V/m, 1.4 - 2 GHz	Performance Criteria 1
Output, line to earth, 2kV	Performance Criteria 1	3V/m, 2 - 2.7 GHz	Performance Criteria 1
Input, line to line, 1kV	Performance Criteria 2	<b>Conducted Radio Frequency Immunity</b>	IEC/EN 61000-4-6
Input, line to earth, 2kV	Performance Criteria 2	10V/m, 0.15 - 80 MHz	Performance Criteria 1
<b>EMC Emission</b>	IEC/EN 61000-6-4	<b>Voltage Dips Immunity</b>	IEC/EN 61000-4-11
<b>Radio Interference</b>		0% for 10ms/20ms	Performance Criteria 2
<b>Voltage Emission (Conducted)</b> 0.15 - 30MHz	IEC/EN 55011	40% for 200ms	Performance Criteria 2
	Class A (industrial) with filters - see filter information	70% for 500ms	Performance Criteria 2
	IEC/EN 60947-4-2, 60947-4-3	<b>Voltage Interruptions Immunity</b>	IEC/EN 61000-4-11
	Class A (no filtering needed)	0% for 5000ms	Performance Criteria 2
		<b>Radio Interference</b> <b>Field Emission (Radiated)</b> 30 - 1000MHz	IEC/EN 55011 Class A (industrial)

## Environmental Specifications

Operating Temperature <sup>11</sup>	-40°C to 80°C (-40°F to +176°F)	Vibration resistance (2-100Hz, IEC60068-2-26, EN50155, EN61373)	2g per axis
Storage Temperature	-40°C to 100°C (-40°F to +212°F)	Relative humidity	95% non-condensing @ 40°C
RoHS (2002/95/EC)	Compliant	UL flammability rating (housing)	UL 94 V0
Impact resistance (EN50155, EN61373)	15/11 g/ms		
Weight		RGC..30 (P)	approx 375g (412g)
RGC..15	approx 260g	RGC..4x (P)	approx 515g (581g)
RGC..20 (P)	approx 315g (360g)	RGC..6x (P)	approx 972g (1020g)
RGC..25 (P)	approx 260g (307g)	RGC..90 (P)	approx 1100g

11. Operating temperature range for RGC..P (overtemperature protection) is -30°C to 70°C (-22°F to 158°F)

12. Applicable to models RGC1...15KGU, RGC1...20KGU, RGC1...25KGU and RGC1...30KGU

## Filtering - EN / IEC 55011 Class A compliance (for class B compliance contact us)

Part Number	Suggested filter for compliance	Maximum Heater current
RGC1A23..15	68 nF / 275V / X1	20A
RGC1A23..20	68 nF / 275 V / X1	20A
RGC1A23..25, RGC1A23..30	220 nF / 275V / X1	30A
RGC1A23..40	220 nF / 275V / X1 330 nF / 275V / X1	30A 45A
RGC1A23..60	220 nF / 275V / X1 330 nF / 275V / X1	30A 45A
RGC1A23..42, RGC1A23..62	330 nF / 275V / X1	35A
RGC1A23..9x	470 nF / 275V / X1	65A
RGC1A60..15	100 nF / 760V / X1	20A
RGC1A60..20	100 nF / 760V / X1	20A
RGC1A60..25, RGC1A60..30	220 nF / 760V / X1	30A
RGC1A60..40	220 nF / 760V / X1 330 nF / 760V / X1	25A 45A
RGC1A60..60	220 nF / 760V / X1 330 nF / 760V / X1	25A 45A
RGC1A60..42, RGC1A...62, RGC1A...9x	330 nF / 760V / X1 470 nF / 760V / X1	40A 65A

Note:

- Control input lines must be installed together to maintain products' susceptibility to Radio Frequency interference.
- Use of AC solid state relays may, according to the application and the load current, cause conducted radio interferences. Use of mains filters may be necessary for cases where the user must meet E.M.C requirements. The capacitor values given inside the filtering specification tables should be taken only as indications, the filter attenuation will depend on the final application.
- Performance Criteria 1: No degradation of performance or loss of function is allowed when the product is operated as intended.
- Performance Criteria 2: During the test, degradation of performance or partial loss of function is allowed. However when the test is complete the product should return operating as intended by itself.
- Performance Criteria 3: Temporary loss of function is allowed, provided the function can be restored by manual operation of the controls.

## Filter Connection Diagrams

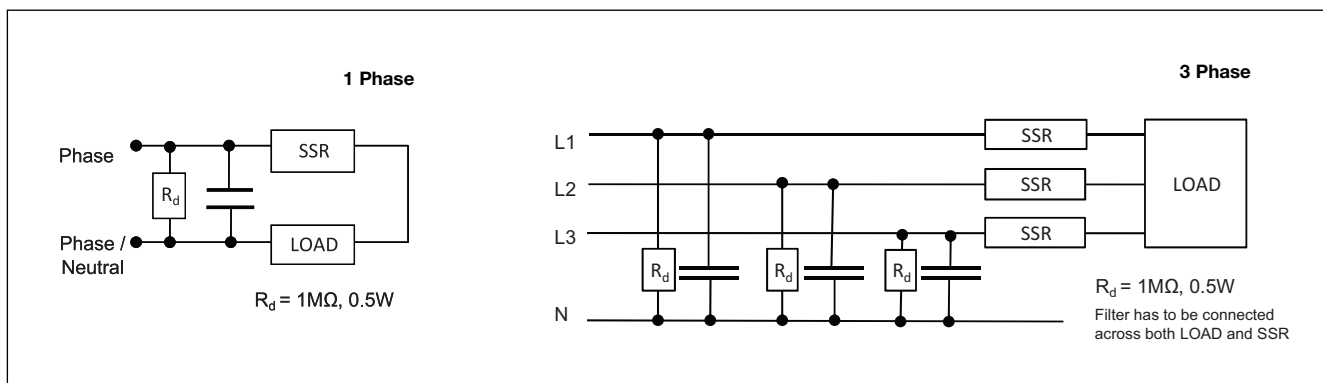

## Connection Diagram (No OTP)

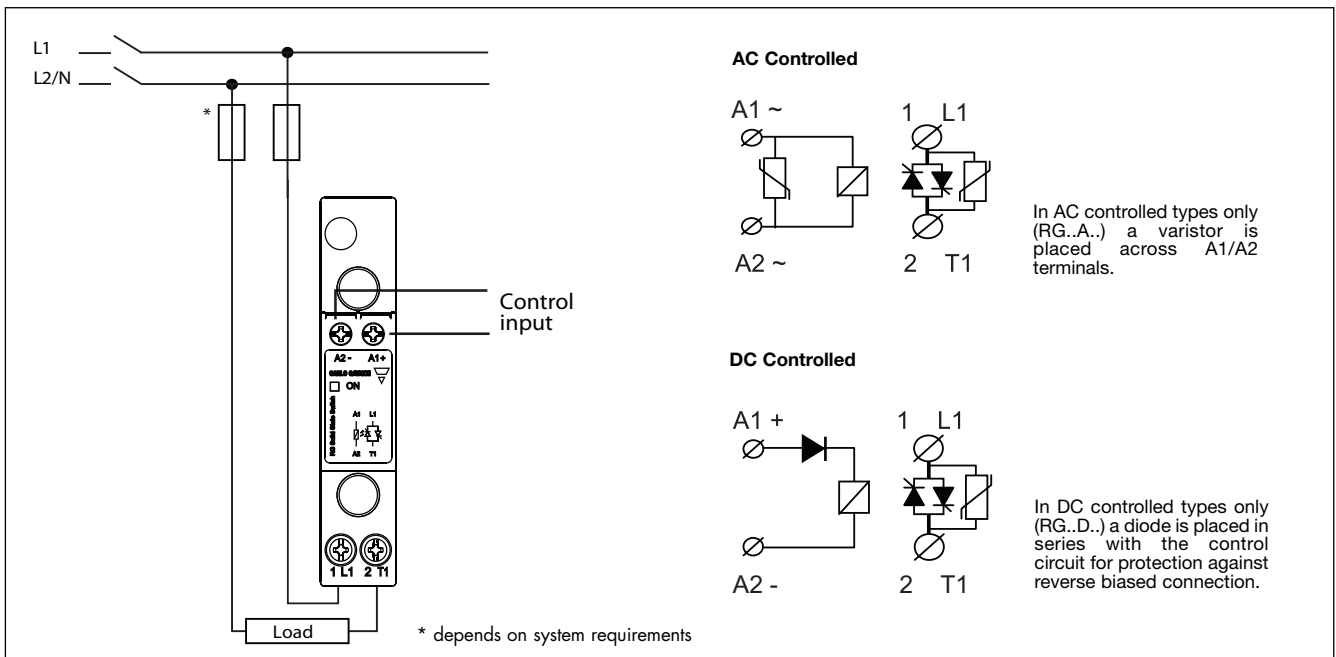

## Connection Diagram (with OTP)

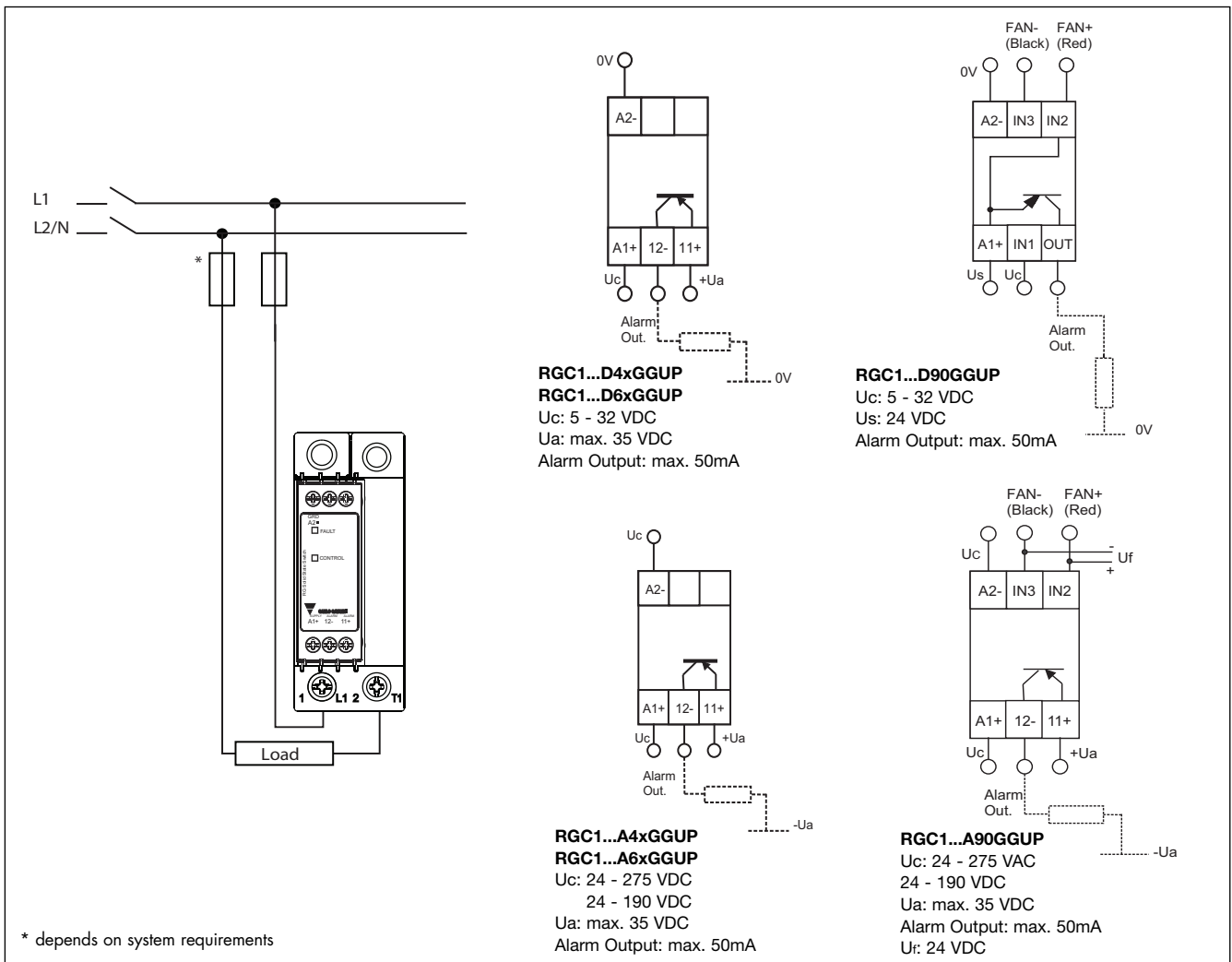

# Terminal Layout and Dimensions

RGC...15KGU, RGC...25KGU

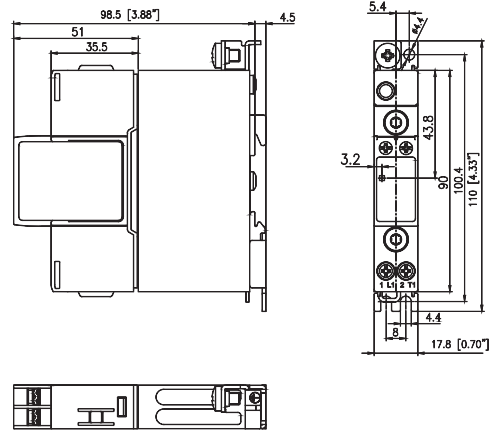
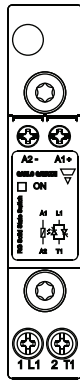

RGC...20KGU

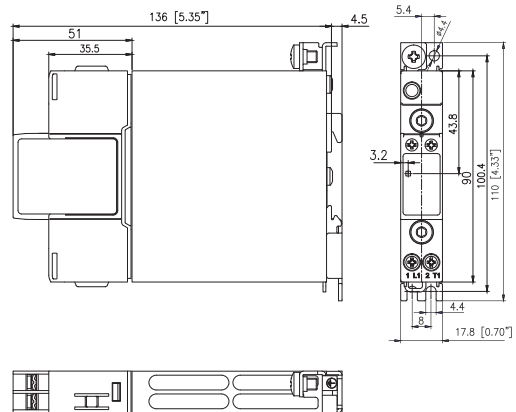
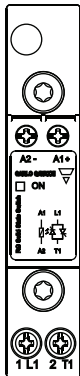

RGC...30KGU

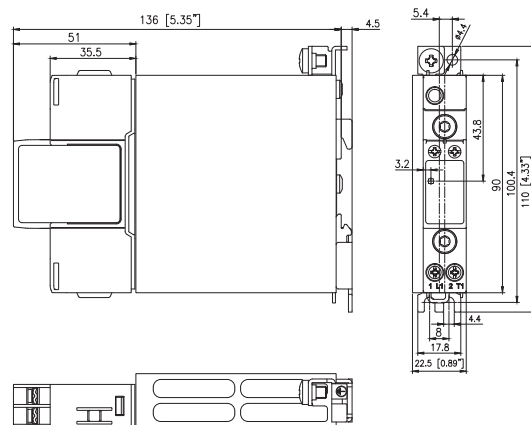
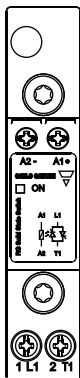

1/L1: Supply connection  
 2/T1: Load connection  
 A1 (+): Positive control signal  
 A2 (-): Control ground  
 ⊕ : Protective earth

Housing width tolerance +0.5mm, -0mm...as per DIN43880.  
 All other tolerances ± 0.5mm. All dimensions in mm.

# Terminal Layout and Dimensions

## RGC...40KGU, RGC...42KGU

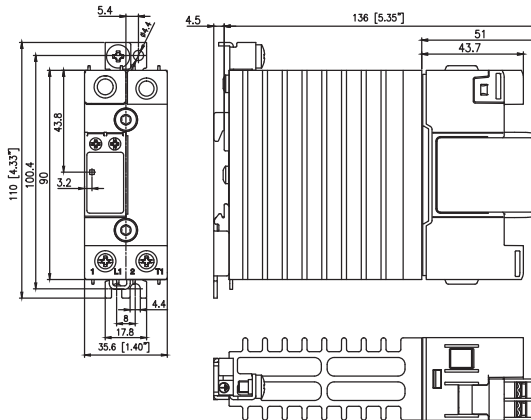
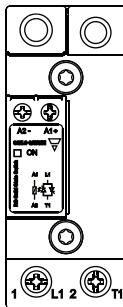

## RGC...60KGU, RGC...62KGU

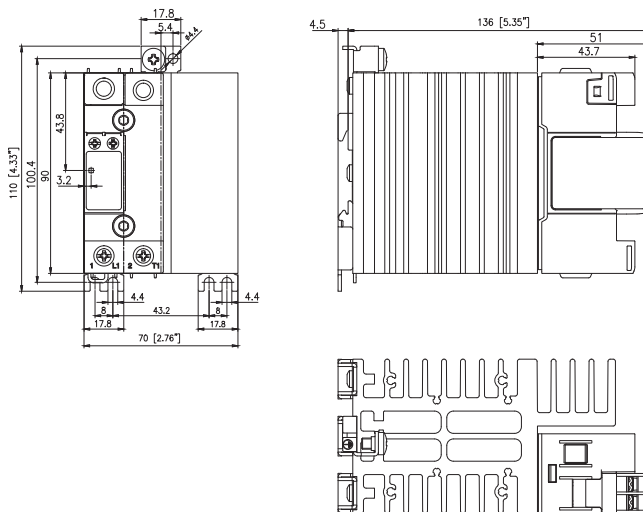
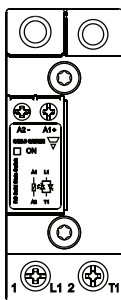

- 1/L1: Supply connection
- 2/T1: Load connection
- A1 (+): Positive control signal  
(Positive supply in case of RGC1A..D90GGUP)
- A2 (-): Control ground
- IN1: Control signal (only for RGC1A.. D90GGUP)
- IN2: Fan + supply (only for RGC1A60A90GGUP)
- IN3: Fan - supply (only for RGC1A60A90GGUP)
- 11 + : Alarm output (+)
- OUT, 12 - : Alarm output (-)
-  : Protective earth

Housing width tolerance +0.5mm, -0mm...as per DIN43880.  
All other tolerances ± 0.5mm. All dimensions in mm.



## Terminal Layout and Dimensions (cont.)

### RGC...40GGUP, RGC...42GGUP

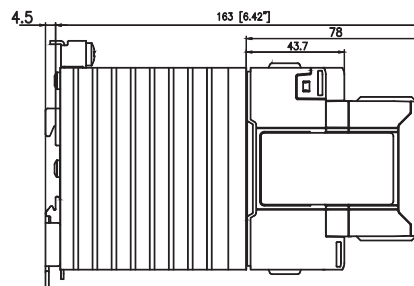
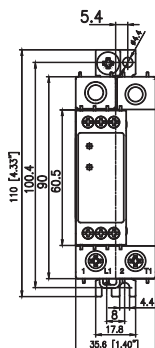

### RGC...60GGUP, RGC...62GGUP

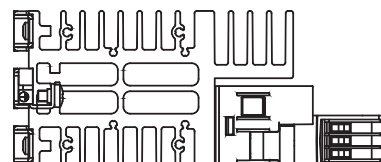
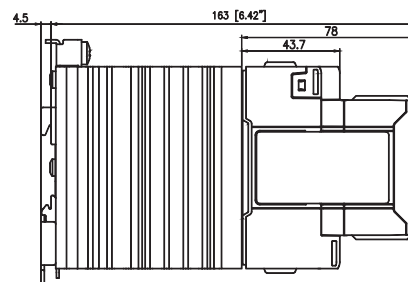
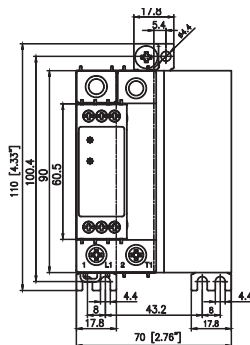
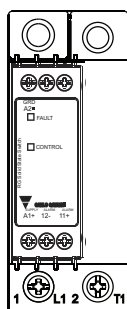

### RGC...90GGUP

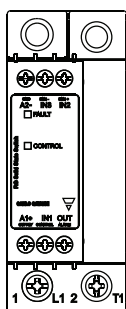

RGC..D90GGUP

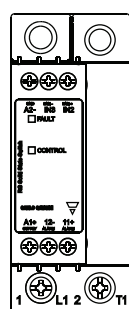

RGC..A90GGUP

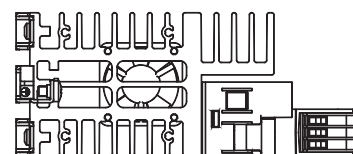
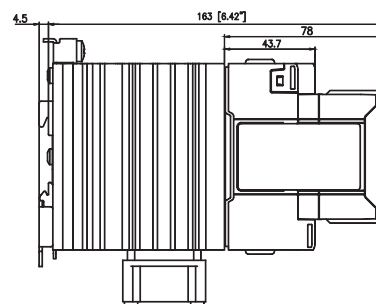
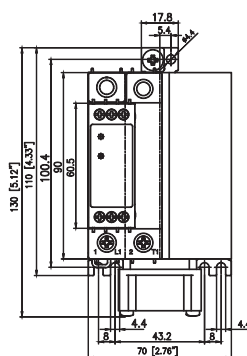







- 1/L1: Supply connection
- 2/T1: Load connection
- A1 (+): Positive control signal  
(Positive supply in case of RGC1A..D90GGUP)
- A2 (-): Control ground
- IN1: Control signal (only for RGC1A..D90GGUP)
- IN2: Fan + supply (only for RGC1A60A90GGUP)
- IN3: Fan - supply (only for RGC1A60A90GGUP)
- 11 + : Alarm output (+)
- OUT, 12 - : Alarm output (-)
- ⊕ : Protective earth

Housing width tolerance +0.5mm, -0mm...as per DIN43880.  
All other tolerances ± 0.5mm. All dimensions in mm.

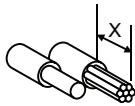
## Connection Specifications

### POWER CONNECTIONS: 1/L1, 2 /T1

Use 75°C copper (Cu) conductors

	RG..KGU	RG..KGU, RG..GGUP
<b>Stripping Length (X)</b>	12mm	11mm
<b>Connection type</b>	M3.5 screw with box clamp	M5 screw with box clamp
<b>Rigid (Solid &amp; Stranded)</b> UL/ cUL rated data	 1 x 1..6 mm <sup>2</sup> 1 x 18.. 10 AWG	 1 x 2.5..25mm <sup>2</sup> 1 x 14...3 AWG
<b>Flexible with end sleeve</b>	 1 x 0.5..2.5mm <sup>2</sup> 1 x 20.. 14 AWG	 1 x 2.5..16mm <sup>2</sup> 1 x 14.. 6 AWG
<b>Flexible without end sleeve</b>	 1 x 1.. 4mm <sup>2</sup> 1 x 18.. 12 AWG	 1 x 4.. 25mm <sup>2</sup> 1 x 12.. 3 AWG
<b>Torque specifications</b>	 Pozidriv 2 UL: 2Nm (17.7lb-in) IEC: 1.5-2.0Nm (13.3 - 17.7lb-in)	 Pozidriv 2 UL: 2.5Nm (22lb-in) IEC: 2.5-3.0Nm (22 - 26.6lb-in)
<b>Protective Earth (PE) Connection</b>	 1.5Nm (13.3 in-lb)	

Note: M5 PE screw not provided with SSR. PE connection required when product is intended to be used in Class 1 applications according to EN/IEC 61140.

### CONTROL CONNECTIONS: A1(+), A2(-)

Use 60/75°C copper (Cu) conductor

#### Torque specifications

#### RG...KGU

M3, Pozidriv 1  
UL: 0.5Nm (4.4lb-in)  
IEC: 0.5 - 0.6Nm (4.4 - 5.3lb-in)



#### Stripping Length (X)

8mm

#### Rigid (Solid & Stranded)

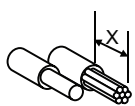
UL/ cUL rated data



	
2 x 0.5..2.5mm <sup>2</sup> 2 x 18..12 AWG	1 x 0.5..2.5mm <sup>2</sup> 1 x 18..12 AWG

#### Flexible with end sleeve



2 x 0.5..2.5mm <sup>2</sup> 2 x 18..12AWG	1 x 0.5..2.5mm <sup>2</sup> 1 x 18..12AWG
--	--

### CONTROL CONNECTIONS: A1(+), A2(-), IN1, IN2, IN3, 11 (+), 12(-), OUT

Use 60/75°C copper (Cu) conductors

#### Torque specifications

#### RG...GGUP

M3, Pozidriv 1  
UL: 0.5Nm (4.4lb-in)  
IEC: 0.4 - 0.5Nm (3.5 - 4.4lb-in)



#### Stripping Length (X)

6mm

#### Rigid (Solid & Stranded)

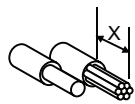
UL/ cUL rated data



	
2 x 1.0..2.5mm <sup>2</sup> 2 x 18..14 AWG	1 x 1.0..2.5mm <sup>2</sup> 1 x 18..14 AWG

#### Flexible with end sleeve



2 x 1.0..2.5mm <sup>2</sup> 2 x 18..14AWG	1 x 1.0..2.5mm <sup>2</sup> 1 x 18..14AWG
--	--

## Installation Instructions

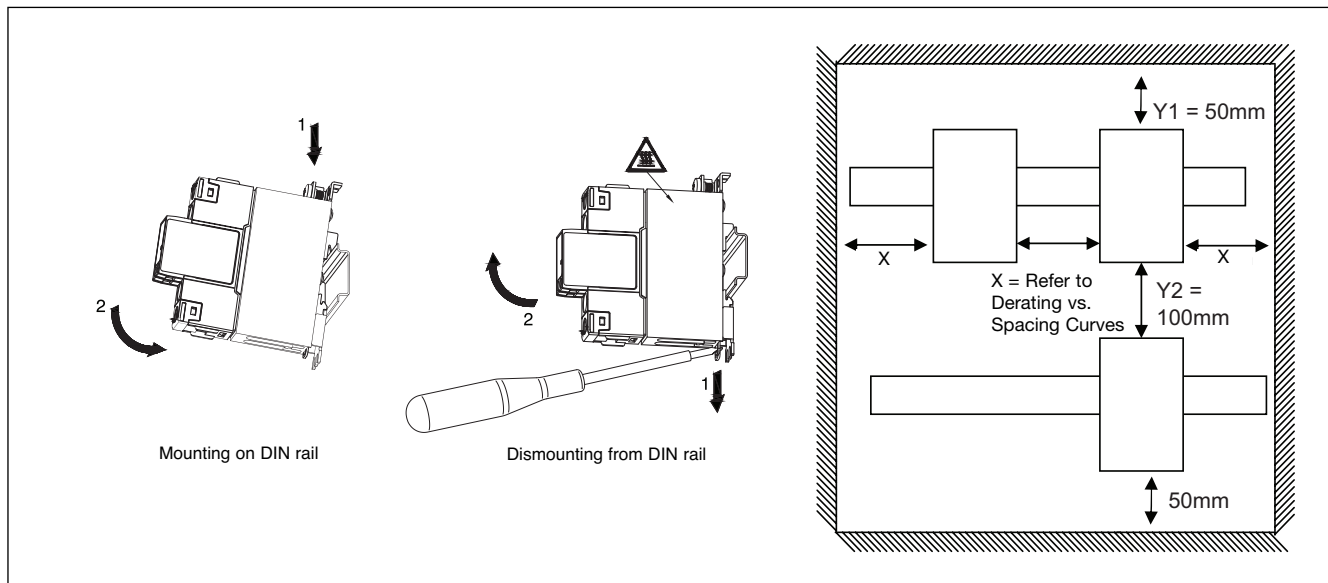

## Short Circuit Protection

### Protection Co-ordination, Type 1 vs Type 2:

Type 1 protection implies that after a short circuit, the device under test will no longer be in a functioning state. In type 2 co-ordination the device under test will still be functional after the short circuit. In both cases, however the short circuit has to be interrupted. The fuse between enclosure and supply shall not open. The door or cover of the enclosure shall not be blown open. There shall be no damage to conductors or terminals and the conductors shall not separate from terminals. There shall be no breakage or cracking of insulating bases to the extent that the integrity of the mounting of live parts is impaired. Discharge of parts or any risk of fire shall not occur.

The product variants listed in the table hereunder are suitable for use on a circuit capable of delivering not more than 100,000A rms Symmetrical Amperes, 600 Volts maximum when protected by fuses. Tests at 100,000A were performed with Class J fuses, fast acting; please refer to the table below for maximum allowed ampere rating of the fuse. Use fuses only.

Tests with class J fuses are representative of Class CC fuses.

## Co-ordination type 1 (UL508)

Part No.	Prospective short circuit current [kArms]	Max. fuse size [A]	Class	Voltage [VAC]
RGC..15	100	10	J	max. 600
	100	15	CC	max. 600
RGC..20	100	10	J	max. 600
	100	15	CC	max. 600
RGC..25	100	30	J or CC	max. 600
RGC..30	100	30	J or CC	max. 600
RGC..40	100	40	J	max. 600
RGC..42	100	90	J	max. 600
RGC..60	100	40	J	max. 600
RGC..62	100	90	J	max. 600
RGC..90	100	40	J	max. 600

## Co-ordination type 2 (IEC EN 60947-4-2/ -4-3)

Part No.	Prospective short circuit current [kArms]	Ferraz Shawmut		Siba		Voltage [VAC]
		Max fuse size [A]	Part number	Max fuse size [A]	Part number	
RGC..15	10	25	6.9xx CP GRC 14x51 /25	32	50 142 06.32	max. 600
	100	25	6.9xx CP GRC 14x51 /25	32	50 142 06.32	max. 600
RGC..20	10	40	6.6xx CP URD 22x58 /40	32	50 142 06.32	max. 600
	100	40	6.6xx CP URD 22x58 /40	32	50 142 06.32	max. 600
RGC..25	10	40	6.9xx CP GRC 22x58 /40	32	50 142 06.32	max. 600
	100	40	6.6xx CP URD 22x58 /40	32	50 142 06.32	max. 600
RGC..30	10	40	6.9xx CP GRC 22x58 /40	32	50 142 06.32	max. 600
	100	40	6.6xx CP URD 22x58 /40	32	50 142 06.32	max. 600
RGC..40	10	63	6.621 CP URGD 27x60 /63	63	50 194 20.63	max. 600
	10	70	A70QS70-4	63	50 194 20.63	max. 600
	100	63	6.621 CP URQ 27x60 /63	63	50 194 20.63	max. 600
RGC..42	10	63	6.9xx CP URC 14x51 /63	80	50 194 20.80	max. 600
	10	70	A70QS70-4	80	50 194 20.80	max. 600
	100	63	6.9xx CP URC 14x51 /63	80	50 194 20.80	max. 600
	100	70	A70QS70-4	80	50 194 20.80	max. 600
RGC..60 up to 65AAC	10	80	6.621 CP URQ 27x60 /80	80	50 194 20.80	max. 600
	100	n/a	n/a	80	50 194 20.80	max. 600
RGC..62	10	100	6.9xx CP GRC 22x58 /100	100	50 194 20.100	max. 600
	10	100	A70QS100-4	100	50 194 20.100	max. 600
	100	100	6.621 CP URGD 27x60 /100	100	50 194 20.100	max. 600
	100	100	A70QS100-4	100	50 194 20.100	max. 600
RGC..90 up to 80AAC	10	100	6.621 CP URQ 27x60 /100	100	50 194 20.100	max. 600
	10	100	A70QS100-4	100	50 194 20.100	max. 600
	100	n/a	n/a	100	50 194 20.100	max. 600

## Type 2 Protection with Miniature Circuit Breakers (M.C.B.s)

Solid State Relay type	ABB Model no. for Z - type M. C. B. (rated current)	ABB Model no. for B - type M. C. B. (rated current)	Wire cross sectional area [mm <sup>2</sup> ]	Minimum length of Cu wire conductor [m] <sup>13</sup>
RGC..15, RGC..20	<b>1 pole</b> S201 - Z4 (4A) S201 - Z6 UC (6A)	S201 - B2 (2A) S201 - B2 (2A)	1.0	21.0
			1.0	21.0
			1.5	31.5
RGC..25, RGC..30	<b>1 pole</b> S201 - Z10 (10A)	S201-B4 (4A)	1.0	7.6
			1.5	11.4
			2.5	19.0
	S201 - Z16 (16A)	S201-B6 (6A)	1.0	5.2
			1.5	7.8
			2.5	13.0
	S201 - Z20 (20A)	S201-B10 (10A)	1.5	12.6
			2.5	21.0
	S201 - Z25 (25A)	S201-B13 (13A)	2.5	25.0
			4.0	40.0
	<b>2 pole</b> S202 - Z25 (25A)	S202-B13 (13A)	2.5	19.0
			4.0	30.4
RGC..40	<b>1 pole</b> S201 - Z25 (25A)	S201-B13 (13A)	2.5	7.0
			4.0	11.2
			6.0	16.8
RGC..60	<b>1 pole</b> S201 - Z25 (25A)	S201-B13 (13A)	2.5	7.0
			4.0	11.2
			6.0	16.8
RGC..90GGUP	<b>1 pole</b> S201 - Z20 (20A)	S201-B10 (10A)	1.5	4.2
			2.5	7.0
			4.0	11.2
	S201 - Z32 (32A)	S201-B16 (16A)	2.5	13.0
			4.0	20.8
			6.0	31.2
	<b>2 pole</b> S202 - Z20 (20A)	S202-B10 (10A)	1.5	1.8
			2.5	3.0
			4.0	4.8
	S202 - Z32 (32A)	S202-B16 (16A)	2.5	5.0
			4.0	8.0
			6.0	12.0
10.0			20.0	
S202 - Z50 (50A)	S202-B25 (25A)	4.0	14.8	
		6.0	22.2	
		10.0	37.0	
RGC..42, RGC..62	<b>1 pole</b> S201-Z32 (32A)	S201-B16 (16A)	2.5	3.0
			4.0	4.8
			6.0	7.2
	S201-Z50 (50A)	S201-B25 (25A)	4.0	4.8
			6.0	7.2
			10.0	12.0
			16.0	19.2
	S201-Z63 (63A)	S201-B32 (32A)	6.0	7.2
			10.0	12.0
			16.0	19.2

13. Between MCB and Load (including return path which goes back to the mains).

Note: A prospective current of 6kA and a 230/400V power supply system is assumed for the above suggested specifications. For cables with different cross section than those mentioned above please consult Carlo Gavazzi's Technical Support Group.