

Features

Regulated Converters

- UL/ RAILWAYS Certified Constant Current LED Driver
- Wide Input and Output Voltage Range
- Digital PWM and Analogue Voltage Dimming
- Short Circuit and Overtemperature Protected
- Pinned or Wired Versions
- IP67 rated for /W Version
- 96% Efficiency
- 5 year Warranty

Description

The RCD series is a step-down constant current source designed for driving high power white LEDs. Standard output currents available are 300mA, 350mA, 500mA, 600mA, 700mA, 1000mA and 1200mA to make this driver compatible with a wide range of LEDs applications. Despite its compact size, the RCD series is fully featured with very high efficiency, wide input voltage range, high ambient operating temperature and two means of dimming: PWM/digital control and analogue voltage dimming. Both dimming controls are independent and can be combined. The driver is also designed to be as reliable as the LEDs it is driving, even at the full operating temperature. Options include an IP67-rated wired version (/W) and a version with built-in reference output voltage (/Vref) to power sensors or for easy analogue dimming.

Selection Guide

| Part Number | Input Range (VDC) | Output Current (mA) | Output Voltage (Vmin-Vmax) | Dimming Control | Options | Mounting Style |
|-------------------------------|-------------------|---------------------|----------------------------|--------------------|---------|----------------|
| RCD-24-0.30 ^{(a)(b)} | 4.5-36V | 0-300 | 2-35 | Digital + Analogue | Vref | Pins or Wired |
| RCD-24-0.35 ^{(a)(b)} | 4.5-36V | 0-350 | 2-35 | Digital + Analogue | Vref | Pins or Wired |
| RCD-24-0.50 ^{(a)(b)} | 4.5-36V | 0-500 | 2-35 | Digital + Analogue | Vref | Pins or Wired |
| RCD-24-0.60 ^{(a)(b)} | 4.5-36V | 0-600 | 2-35 | Digital + Analogue | Vref | Pins or Wired |
| RCD-24-0.70 ^{(a)(b)} | 4.5-36V | 0-700 | 2-35 | Digital + Analogue | Vref | Pins or Wired |
| RCD-24-1.00 ^(b) | 6-36V | 0-1000 | 3-31 | Digital + Analogue | | Pins or Wired |
| RCD-24-1.20 ^(b) | 6-36V | 0-1200 | 3-31 | Digital + Analogue | | Pins or Wired |

^{(a)(b)} Standard is no suffix with PCB Pins.

^(a) Add suffix /Vref for pinned version with Vref output and analogue dimming

^(b) Add suffix /W for wired version without dimming control (four wires)

^(b) Add suffix /W/X1 for wired version with analogue dimming control (five wires)

^(b) Add suffix /W/X2 for wired version with PWM dimming control (five wires)

^(b) Add suffix /W/X3 for wired version with both analogue and PWM dimming controls (six wires)

^(a) Add suffix /W/Vref for wired version with Vref output and analogue dimming (six wires)

Specifications (typical at 25°C, nominal input voltage, rated output current unless otherwise specified)

| | | |
|--------------------------------------|-----------------------------------|------------------------------------|
| Input Voltage (absolute maximum) | 40VDC max | |
| Recommended Input Voltage | 300mA-700mA | 5V min. / 24V typ. / 36VDC max |
| | 1000mA-1200mA | 6V min. / 24V typ. / 36VDC max |
| Input Filter | Capacitor | |
| Output Current Accuracy (Vin = 24DC) | 300mA-700mA | ±1% typ, ±3% max. |
| | 1000mA-1200mA | ±2% typ, ±5% max. |
| Internal Power Dissipation | Worst case load of 5 LEDs | 800mW max |
| Output Current Stability | Vin=36V, Vout =1-9 LEDs | ±1% max |
| Output Ripple and Noise (20MHz BW) | 300mA-700mA | 150mVp-p max |
| Vin=36V, Vout =1-9 LEDs | 1000mA-1200mA | 300mVp-p max |
| Temperature Coefficient | -40°C to +85°C ambient | ±0.015%/°C max |
| Maximum Capacitive Load | 100µF | |
| Operating Frequency | 300mA-700mA | 210kHz min/ 250kHz typ/ 280kHz max |
| | 1000mA-1200mA | 350kHz min/ 450kHz typ/ 550kHz max |
| Efficiency at Full Load | 96% max. | |
| Short Circuit Protection | Regulated at rated output current | |

continued on next page

LIGHTLINE

DC/DC-Converter

with 5 year Warranty

RECOM

Constant Current LED Driver



E358085

EN-50121-3-2 Certified

EN-60950-1 Certified

UL-60950-1 Certified

RCD-24

Derating Graph (Ambient Temperature)

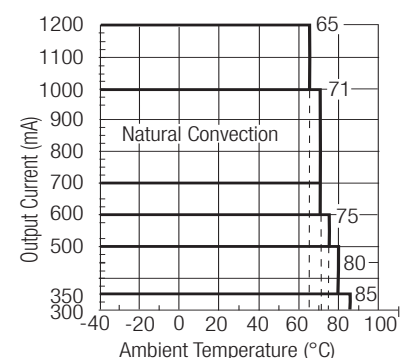

Refer to Application Notes

Specifications (typical at 25°C, nominal input voltage, rated output current unless otherwise specified)

| | | |
|--|--------------|----------------|
| Operating Temperature Range (free air convection) | 300mA-350mA | -40°C to +85°C |
| | 500mA | -40°C to +80°C |
| | 600mA | -40°C to +75°C |
| | 700mA-1000mA | -40°C to +71°C |
| | 1200mA | -40°C to +65°C |

| | | |
|---------------------------|--|-----------------|
| Storage Temperature Range | | -55°C to +125°C |
|---------------------------|--|-----------------|

| | | |
|--|-------------------------|------------|
| Overtemperature Shutdown (Auto-restart after cool down) | Internal IC Temperature | 150°C typ. |
| | Temperature Hysteresis | 20°C typ. |

| | | |
|--------------------------|--|-------|
| Maximum Case Temperature | | 100°C |
|--------------------------|--|-------|

| | | |
|-------------------|--------------------|-----------|
| Thermal Impedance | Natural Convection | 55°C/Watt |
|-------------------|--------------------|-----------|

| | | |
|--|------------------------------|--|
| Case Material (Pinned or Wired Versions) | Non Conductive Black Plastic | |
|--|------------------------------|--|

| | | |
|---|-----------------|--|
| Potting Material (Pinned or Wired Versions) | Epoxy (UL94-V0) | |
|---|-----------------|--|

| | | |
|------------|--------------|---------------------|
| Dimensions | Pinned/Wired | 22.1 x 12.6 x 8.5mm |
|------------|--------------|---------------------|

| | | |
|--------|--------------|-----------|
| Weight | Pinned/Wired | 4.5g/6.8g |
|--------|--------------|-----------|

| | | |
|-------------------|--------|-------------------|
| Soldering Profile | Pinned | 265°C/10 sec. max |
|-------------------|--------|-------------------|

| | | |
|---|-----------------|----------------|
| Packing Quantities (Refer to App Notes for Tube sizes) | Pinned Versions | 39pcs per Tube |
| | Wired Versions | 5pcs per Bag |

PWM Dimming and ON/OFF Control (Leave open if not used - do not tie to +Vin)

| | | | |
|--------------------|---------------------|---------------|---------------------------|
| Remote ON/OFF | DC/DC ON | 300mA-700mA | Open or $0V < V_r < 0.6V$ |
| Threshold Voltages | | 1000mA-1200mA | Open or $0V < V_r < 0.8V$ |
| | DC/DC OFF (Standby) | 300mA-700mA | $0.6 < V_r < 2.9V$ |

| | | | |
|----------------------|--|---------------|--------------------|
| | | 1000mA-1200mA | $1.4 < V_r < 2.2V$ |
| DC/DC OFF (Shutdown) | | 300mA-700mA | $2.9V < V_r < 6V$ |
| | | 1000mA-1200mA | $2.2V < V_r < 15V$ |

| | | | |
|--|----------------|-----------|--|
| Remote Pin Drive Current | $V_r = 5V$ | 1mA max | |
| Quiescent Input Current in Shutdown Mode | $V_{in} = 36V$ | 200µA max | |

| | | | |
|-----------------------|----------------------|-------------|--|
| Maximum PWM Frequency | For Linear Operation | 200Hz max. | |
| | Frequency Limit | 1000Hz max. | |

Analogue Dimming Control (leave open if not used - do not tie to +Vin)

| | | |
|----------------------|--------------|-------------|
| Input Voltage Limits | Standard | -0.3V - 15V |
| | Vref Version | -0.3V - 5V |

| | | |
|---------------------------------------|----------------------------|-------------------|
| Control Voltage Range (see Graphs) | Full On | $0.13V \pm 50mV$ |
| | 300, 700, 1200mA: Full Off | $4.2V \pm 150mV$ |
| | 1000mA: Full Off | $4.35V \pm 100mV$ |
| | Vref Version: Full Off | $2.6V \pm 100mV$ |

| | | |
|----------------------------|-----------------------------------|-----------------|
| Analogue Pin Drive Current | $V_c = 5V$ | 0.2mA max. |
| Vref Version | Vref Voltage | $3.3V \pm 70mV$ |
| | Vref Output Current | 5mA |
| | Vref Output Short Circuit Current | 18mA typ. |

Environmental

| | | |
|-------------------|------------------------------|--|
| Relative Humidity | 5% to 95% RH, non-condensing | |
|-------------------|------------------------------|--|

| | | |
|-------------|------|--|
| /W Versions | IP67 | |
|-------------|------|--|

| | | |
|-------------------|---------|--|
| Shock / Vibration | EN61373 | |
|-------------------|---------|--|

| | | |
|--------------|------------------|--|
| EMC Railways | EN50121-3-2:2006 | |
|--------------|------------------|--|

| | | | |
|---------------------|-------------------------|---------|---------|
| Conducted Emissions | (with filter, see note) | EN55022 | Class B |
|---------------------|-------------------------|---------|---------|

| | | | |
|--------------------|----------------------------|---------|---------|
| Radiated Emissions | (all series except >700mA) | EN55022 | Class B |
|--------------------|----------------------------|---------|---------|

| | | | |
|-----|-------------|--|---------|
| ESD | EN61000-4-2 | | Class A |
|-----|-------------|--|---------|

| | | | |
|-------------------|-------------|--|---------|
| Radiated Immunity | EN61000-4-3 | | Class A |
|-------------------|-------------|--|---------|

| | | | |
|----------------|-------------|--|---------|
| Fast Transient | EN61000-4-4 | | Class A |
|----------------|-------------|--|---------|

| | | | |
|--------------------|-------------|--|---------|
| Conducted Immunity | EN61000-4-6 | | Class A |
|--------------------|-------------|--|---------|

| | | |
|--|-------|-----------------------------|
| MTBF (RCD-24-0.70, Nominal Vin, Full Load) | +25°C | 605 x 10 ³ hours |
|--|-------|-----------------------------|

| | | |
|---------------------|-------|-----------------------------|
| using MIL-HDBK 217F | +71°C | 516 x 10 ³ hours |
|---------------------|-------|-----------------------------|

Note:

- Requires an input filter to meet EN55022 Class B conducted emissions - see next page
- All LED Drivers may not be used without a load. They must be switched on the primary side only. Noncompliance may damage the LED or reduce its lifetime.

Digital Dimming

PWM Digital Control Signal

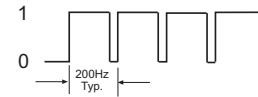

Output Current (LED appears dim)



PWM Digital Control Signal

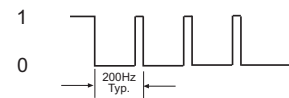

Output Current (LED appears bright)



Analogue Dimming

Standard Version:

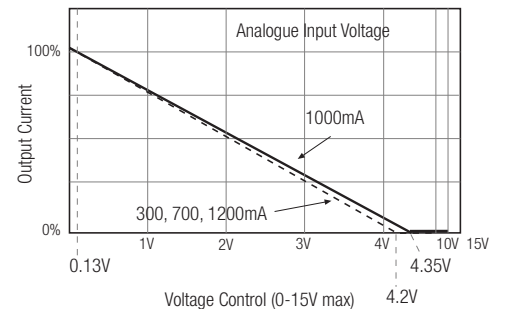

Vref Version:

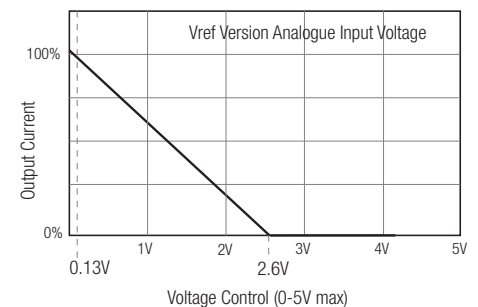

Combined PWM and Analogue Dimming

PWM Digital Control Signal

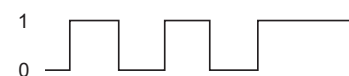

Output Current

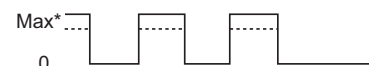

* Max output current can also be set using Analogue input

Typical Characteristics

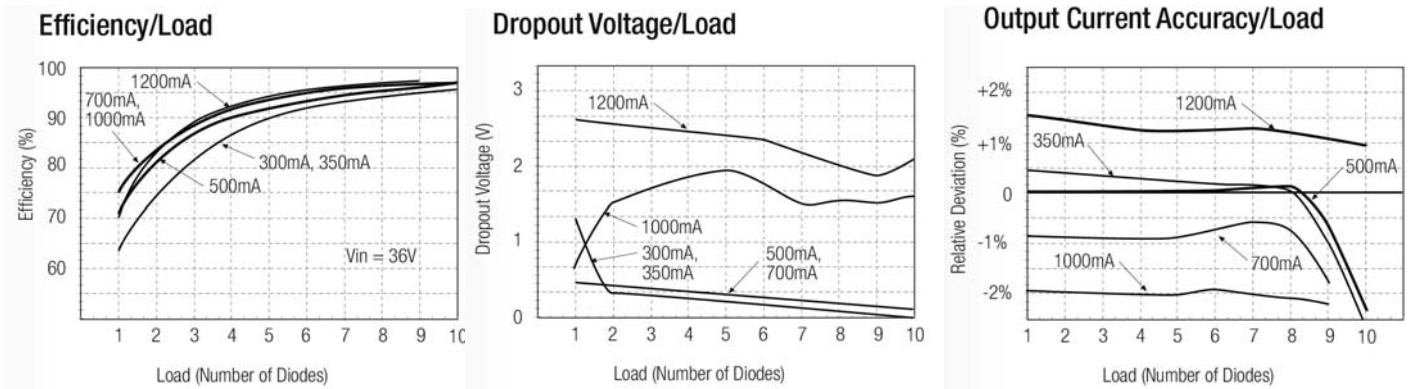

Standard Application Circuit (no external components required for normal use)

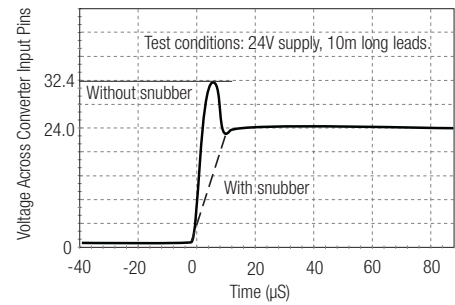
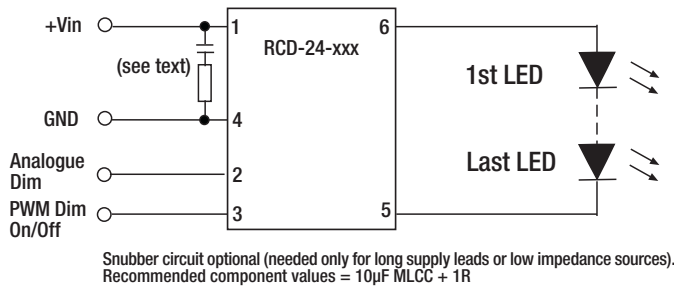

EMI Filter Suggestions

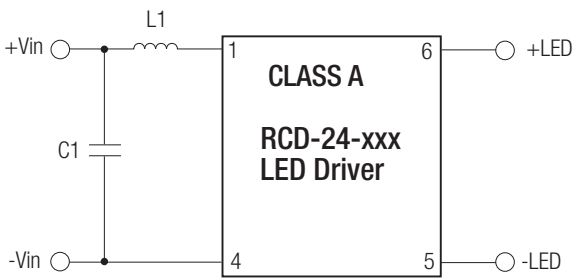

RCD-24-0.30 - RCD-24-0.70

$C1 = 1\mu F$ MLCC

$L1 = 22\mu H$

RCD-24-1.00 - RCD-24-1.20

$C1 = 2.2\mu F$ MLCC

$L1 = 47\mu H$

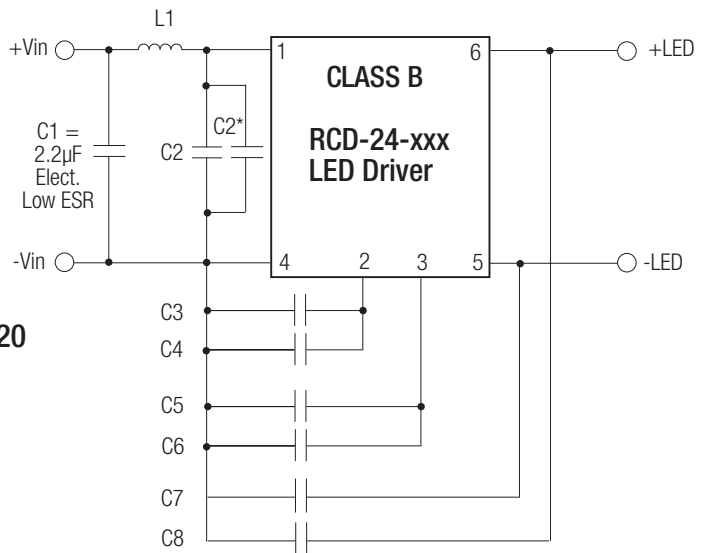

Recommended Class B PCB Layout for Pinned Version

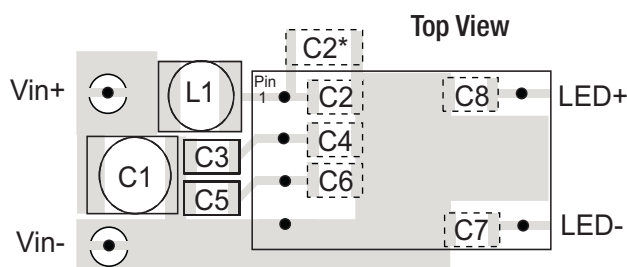

RCD-24-0.30 - RCD-24-0.70

No dimming or PWM dimming:

$L1 = 47\mu H$

$C2 = C3 = 10nF$ MLCC

Other caps not required

Analogue Dimming used:

$L1 = 120\mu H$

$C2 = C7 = 10nF$ MLCC

Other caps not required

RCD-24-1.00 - RCD-24-1.20

$L1 = 220\mu H$

$C2 = 10nF$

$C3 = C5 = 2.2nF$

$C4 = C6 = C7 = C8 = 100nF$

All capacitors MLCC

$C2^*$ = optional $2\mu F$ MLCC only if $L1$ starts to resonate with the back ripple current.

Application Examples

LED DRIVER with 0-10V Interface

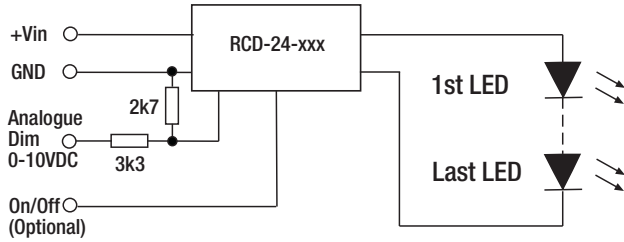

LED DIMMER for up to 10 white LEDs

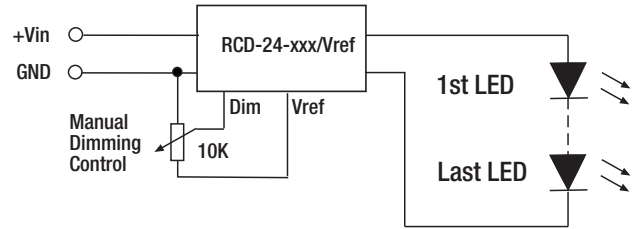

MULTIPLE LED DRIVER (up to 20 LEDs)

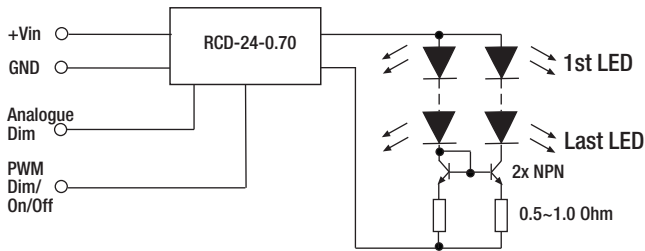

LED DIMMER with high frequency PWM control

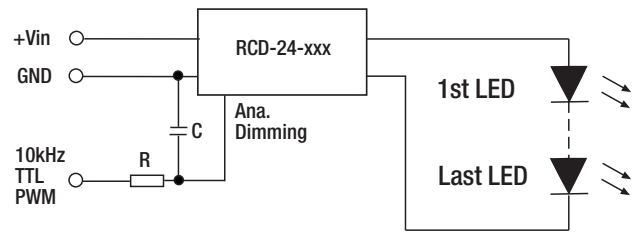

Driving Two Strings of 350mA LEDs with one 700mA Driver using a current mirror

Note:
It is not possible to parallel the drivers to increase the current.

LED Temperature Monitoring

Automatic LED Overtemperature Protection

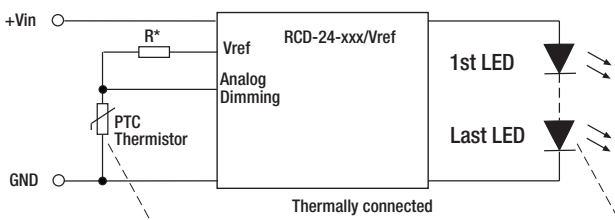

*Typically, choose R so that $R=R_{ptc} @ 85^{\circ}C$ and $R > 660 \Omega$.

Typical Response Curve (PTC = 500 Ohm @ 70°C)

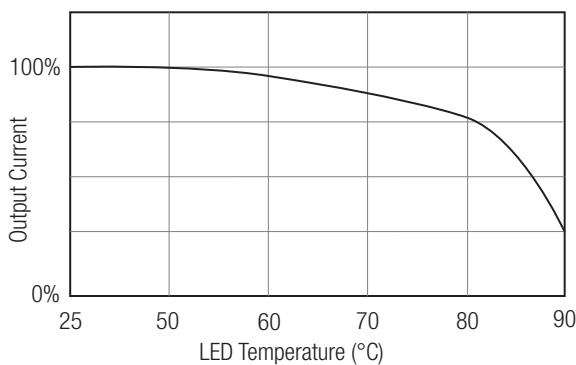

RGB Driver

SIMPLE RGB Mixer

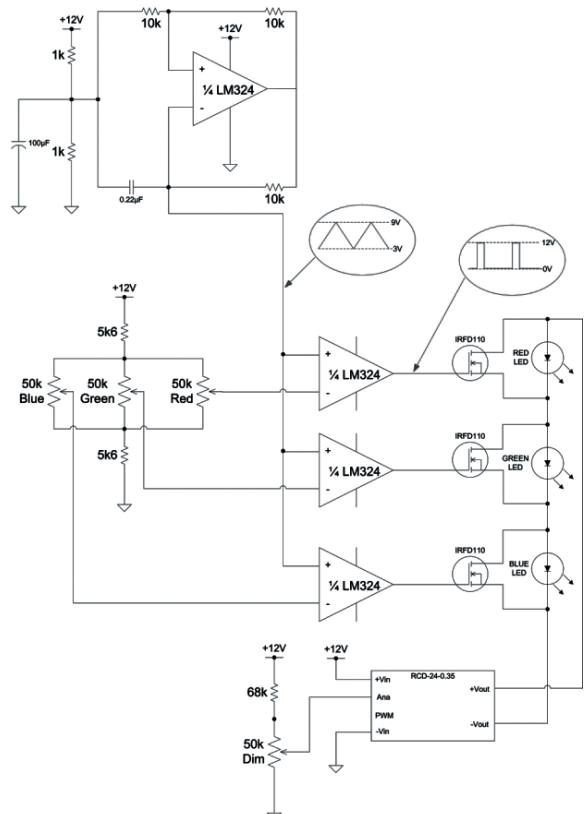

Package Style and Pinning

Pinned Version

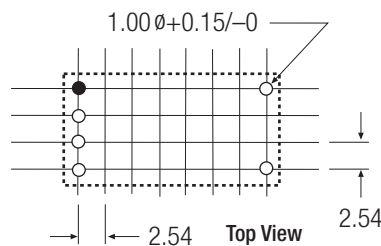
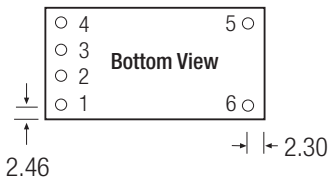
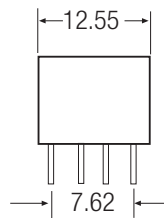
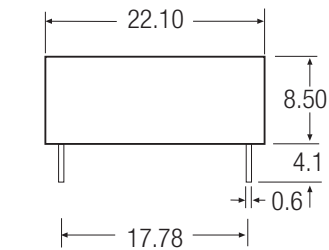

| Pin Connections | | RCD-24 Series | |
|-----------------|------------------|-------------------------|--|
| Pin # | Out | Comments | |
| 1 | +Vin | DC Supply | |
| 2 | Analogue Dimming | Leave open if not used | |
| 3 | PWM/ON/OFF | Leave open if not used | |
| (3 | Vref | Vref Version only) | |
| 4 | GND | Do not connect to -Vout | |
| 5 | -Vout | LED Cathode Connection | |
| 6 | +Vout | LED Anode Connection | |

XX.X ± 0.5 mm
XX.XX ± 0.25 mm
Pin Tolerance ± 0.1 mm

Leave >1mm space around case on PCB for air circulation

Recommended Footprint Details

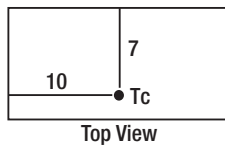

Wired Versions

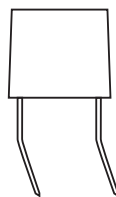
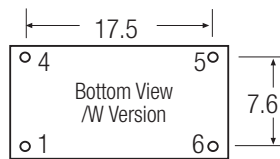

| Wire Connections | | RCD-24/W Series | |
|------------------|----------|-------------------------|--|
| Wire # | Function | Comments | |
| 1 (Red) | +Vin | DC Supply | |
| 4 (Black) | GND | Do not connect to -Vout | |
| 5 (Brown) | -Vout | LED Cathode Connection | |
| 6 (Yellow) | +Vout | LED Anode Connection | |

Wire length = 100mm + 10mm stripped & tinned = 110mm total
Wire outside diameter = 1.6mm
Wire core diameter = 0.75mm
Wire is UL/CSA listed/ 22AWG / 300V Rated

RCD-24

Package Style and Pinning

Wired Versions

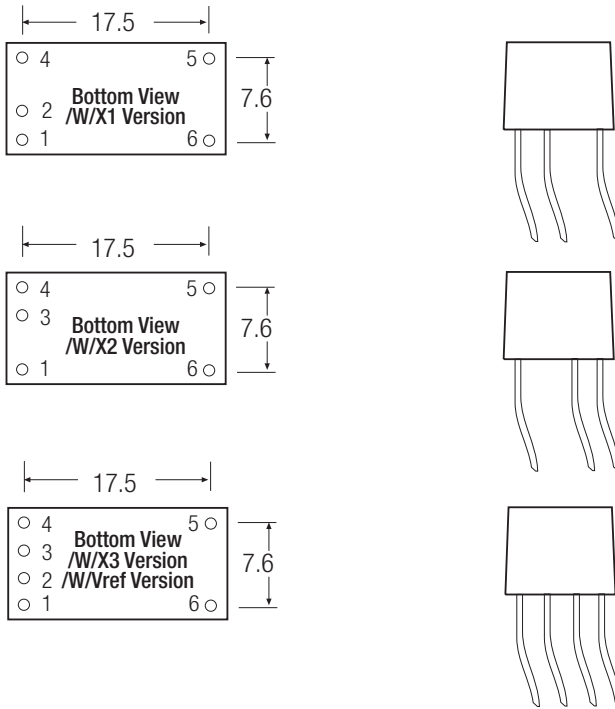

| Wire Connections | RCD-24/W/X Series | |
|------------------------|--------------------|----------|
| Wire # | Function | Comments |
| 2 (Green) | Ana Dimming | /X1 |
| 3 (Blue) | PWM Dimming | /X2 |
| 2 + 3 (Green + Blue) | Ana + PWM Dimming | /X3 |
| 2 + 3 (Green + Yellow) | Ana Dimming + Vref | /Vref |

Wire length = 100mm + 10mm stripped & tinned = 110mm total
 Wire outside diameter = 1.6mm
 Wire core diameter = 0.75mm
 Wire is UL/CSA listed/ 22AWG / 300V Rated

Wired Versions are packed in bags - 5pcs per bag.

Warning: Do not connect or disconnect the LED load while the converter is powered on. This may damage or reduce the lifetime of the LED.