

Features

Regulated Converters

- Universal Input 80-264VAC
- High efficiency up to 77%
- Isolated Output 3kVAC / 1 min
- Short Circuit Protection
- Meet EN55022 Class B
- Low Standby Power Consumption

Description

Compact, low cost, high efficiency, universal input switching AC/DC power module for PCB or wired mounting with single or dual outputs. CE marked and UL/cUL certified.

Selection Guide

Part Number	Input Voltage (VAC)	Output Voltage (VDC)	Output Current (max.)	Efficiency (Typ.)	Max. Capacitive Load (1+2)
RAC05-3.3SC*	80-264	3.3	1250	70	12000µF
RAC05-05SC*	80-264	5	1000	73	6800µF
RAC05-09SC*	80-264	9	556	75	2500µF
RAC05-12SC*	80-264	12	420	76	1500µF
RAC05-15SC*	80-264	15	340	76	750µF
RAC05-24SC*	80-264	24	210	77	330µF
RAC05-05DC*	80-264	±5	±500	73	±3000µF
RAC05-12DC*	80-264	±12	±210	76	±560µF
RAC05-15DC*	80-264	±15	±170	76	±220µF

* add suffix /W for wired version

Specifications (measured at TA 25°C, full load after warm-up)

Input Voltage Range (with derating)	80-264VAC or 115-370VDC	
Rated Power	5 Watts max.	
Input Frequency (for AC Input)	47-440Hz	
Input Current (Full Load)	115VAC / 230VAC	110mA / 70mA typ.
Inrush Current (<2ms)	115VAC / 230VAC	30A / 60A max.
Minimum Load (Specifications valid with 5% min.)	0%	
No Load Power Consumption	0.25W max.	
Recommended External Input Fuse	1.5A / Slow Blow Type	
Output Voltage Accuracy (Full Load)	115VAC / 230VAC	±2% max.
Line Voltage Regulation (Full Load)	LL-HL	±0.3% typ.
Load Voltage Regulation	5-100% Load	±0.5% typ.
Output Ripple&Noise @115/230VAC	3.3V	120mV max.
(20MHz limited with 100nF across output)	All Others	150mV max.
Switching Frequency (Full Load)	132kHz typ.	
Efficiency (Full Load)	see Selection Guide	
Hold-Up Time (Full Load)	115VAC	10ms typ.
Leakage Current	0.85mA max.	
Isolation Voltage	Input-Output	3kVAC / 1minute
Isolation Capacitance	Input-Output	1000pF typ.
Isolation Resistance	Input-Output	1G Ω min.
Short Circuit Protection	Hiccup, Automatic Restart	
Oversvoltage Protection (of Nominal Output Voltage)	3.3V	4.8V - 5.4V
	All Others	110% - 135%
Operating Temperature Range (Natural Convection)	-25°C to +55°C (without Derating) -25°C to +75°C (with Derating)	
Storage Temperature Range	-40°C to +100°C	
Case Material	UL94V-0 Black Plastic	

continued on the next page

POWERLINE

AC/DC-Converter

with 3 year Warranty

RECOM

5 Watt Single / Dual Output

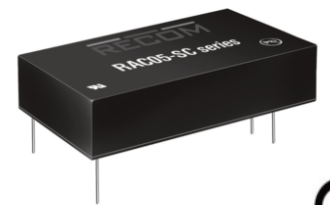

EN-60950-1 Certified
UL-60950-1 Certified

RAC05-C

Derating Graph

(Ambient Temperature)

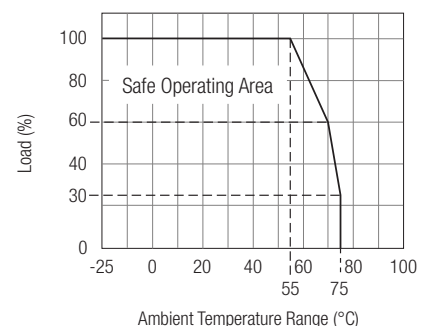

Specifications (measured at TA 25°C, full load after warm-up)

Potting Material		Epoxy UL94V-0
Relative Humidity		95% RH max.
Package Weight		35g / 38g
Packing Quantity	Single Output	10pcs
	Dual Output	9pcs
	Wired Version	1pc
MTBF (25°C)	Using MIL-HDBK 217F	>400 x 10 ³ hours
(65°C)	Using MIL-HDBK 217F	>200 x 10 ³ hours
Emmissions	CE	EN 55022: 2006 + A1: 2007 / Class B
	EMC	EN 55024:1998 + A1:2001 + A2:2003
	Harmonics	EN 61000-3-2:2006 / Class A
	Flicker	EN 61000-3-3:1995 + A1:2001 +A2:2005
Immunity	ESD	IEC 61000-4-2 / Criterion B
	RS	IEC 61000-4-3 / Criterion A
	EFT	IEC 61000-4-4 / Criterion B
	Surge	IEC 61000-4-5 / Criterion B
	CS	IEC 61000-4-6 / Criterion A
	PMF	IEC 61000-4-8 / Criterion A
	Voltage Variations	IEC 61000-4-11 / Criteria B + C
Certifications:		
UL General Safety	Report: E224736	UL-60950-1, 2nd Edition
cUL	Report: E224736	C22.2 No. 60950-1-07, 2nd Edition
EN General Safety	Report: SPCLVD1211033-1	EN-60950-:2006 + A12:2011
CE		EN55022 Class B

Notes:

Note1: Measured @230VAC / 50Hz / Ta=25°C with constant resistant mode at full load.

Note2: If used @115VAC / 60Hz with full load, max. capacitive load is less, please contact RECOM for detailed information

Typical Characteristics

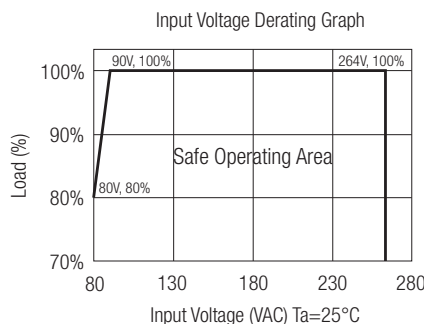
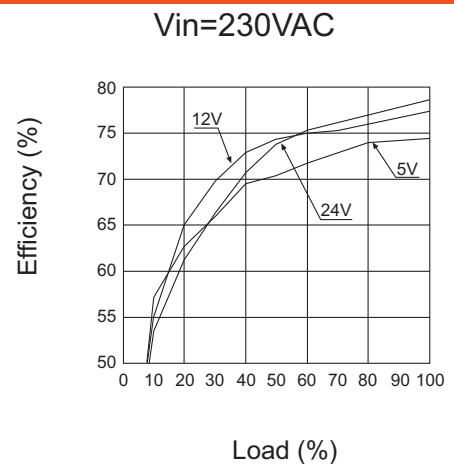
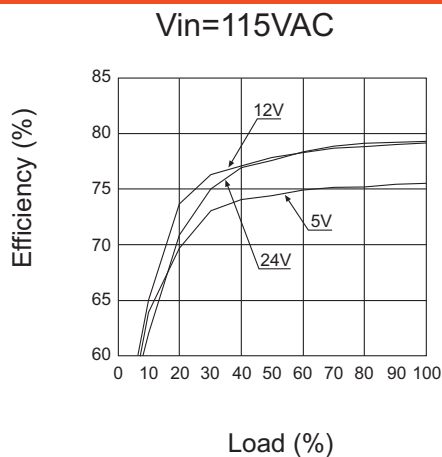

Package Style and Pinning

PCB Mount Version (Standard)

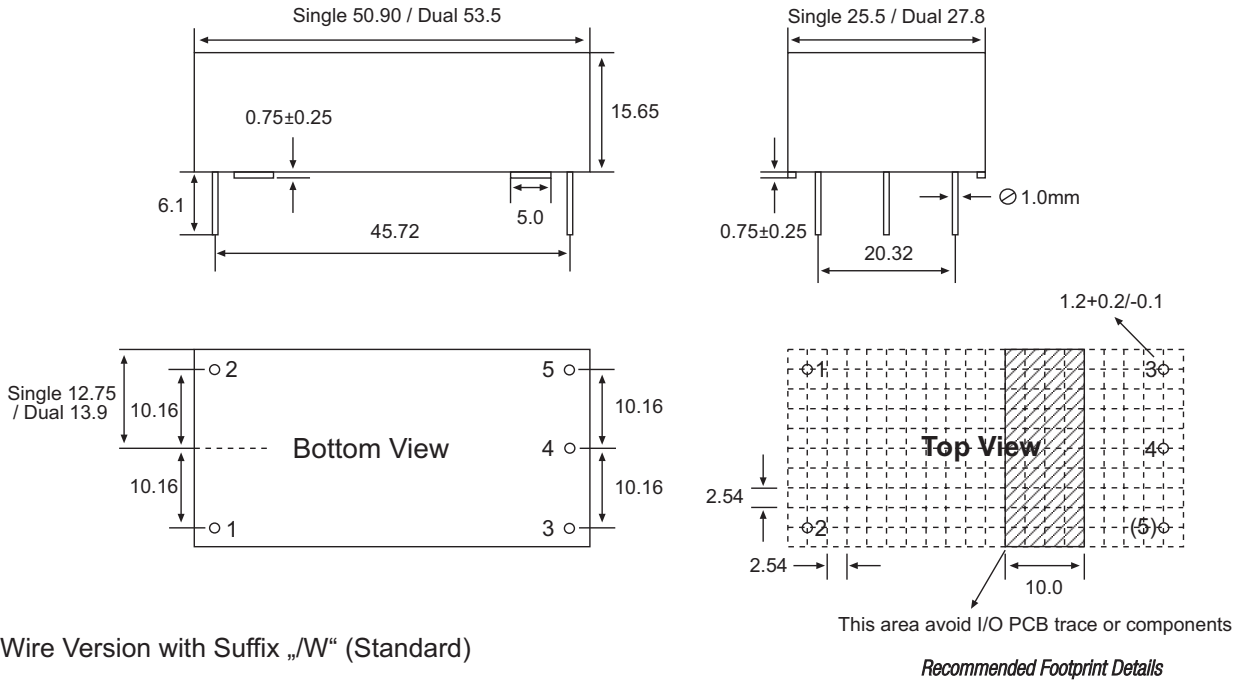

Wire Version with Suffix „W“ (Standard)

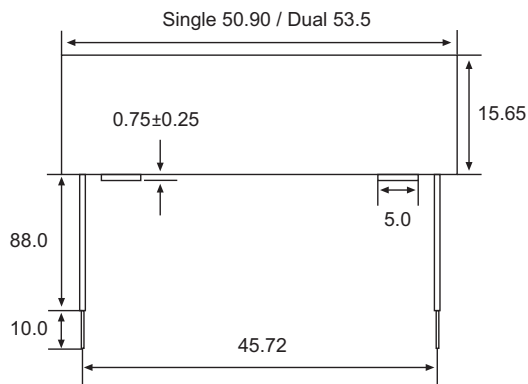

Pin Connections

Pin #	Single Out	Dual Out
1	VAC in (N)	VAC in (N)
2	VAC in (L)	VAC in (L)
3	+VDC out	+VDC out
4	-VDC out	Com
5	no Pin	-VDC out

NC = No Connection
xx.x = ±0.5mm
xx.xx = ±0.25mm

Wire Connections

Pin #			Single out	Dual out
1 (Blue)	AWG#22	1015	VAC in (N)	VAC in (N)
2 (Brown)	AWG#22	1015	VAC in (L)	VAC in (L)
3 (Red)	AWG#22	1007	+VDC out	+VDC out
4 (Black)	AWG#22	1007	-VDC out	Common
5 (Orange)	AWG#22	1007	no Wire	-VDC out

NC = No Connection
xx.x = ±0.5mm
xx.xx = ±0.25mm