

2-line ESD protection for high speed lines

Datasheet - production data

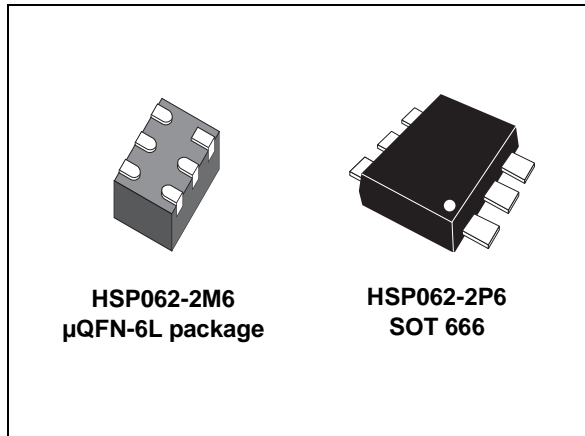
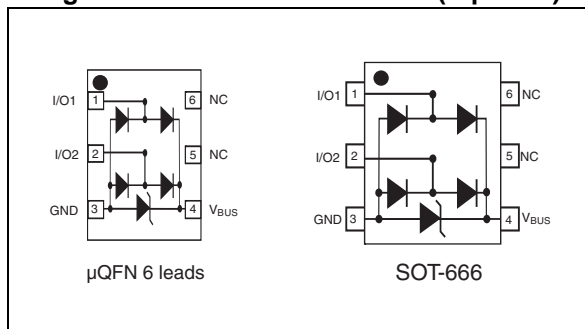

Figure 1. Functional schematic (top view)



Features

- Flow-through routing to keep signal integrity
- Ultralarge bandwidth: 4.6 GHz
- Ultralow capacitance: 0.6 pF
- Low leakage current: 100 nA at 25 °C
- Extended operating junction temperature range: -40 °C to 150 °C
- RoHS compliant

Benefits

- High ESD robustness of the equipment
- Suitable for high density boards

Complies with following standards

- MIL-STD 883G Method 3015-7 Class 3B:
 - 8 kV
- IEC 61000-4-2 level 4:
 - 15 kV (air discharge)
 - 8 kV (contact discharge)

Applications

The HSP062-2 series is designed to protect against electrostatic discharge on sub micron technology circuits driving:

- HDMI 1.3 and 1.4
- Digital Video Interface
- Display Port
- USB 3.0
- Serial ATA
- Ethernet
- HMI

Description

The HSP062-2 is a 2-channel ESD array with a rail to rail architecture designed specifically for the protection of high speed differential lines.

The ultralow variation of the capacitance ensures very low influence on signal-skew. The large bandwidth makes it compatible with 5 Gbps.

The HSP062-2P6 is housed in a SOT-666, while the HSP062-2M6 is packaged in μQFN-6L (1.45 x 1.0 mm) with a 500 μm pitch.

1 Characteristics

Table 1. Absolute maximum ratings $T_{amb} = 25\text{ }^{\circ}\text{C}$

Symbol	Parameter	Value	Unit
V_{PP}	Peak pulse voltage	IEC 61000-4-2 contact discharge	8
		IEC 61000-4-2 air discharge	15
I_{pp}	Repetitive peak pulse current (8/20 μs)	3	A
T_j	Operating junction temperature range	-40 to +150	$^{\circ}\text{C}$
T_{stg}	Storage temperature range	-65 to +150	$^{\circ}\text{C}$
T_L	Maximum lead temperature for soldering during 10 s	260	$^{\circ}\text{C}$

Table 2. Electrical characteristics $T_{amb} = 25\text{ }^{\circ}\text{C}$

Symbol	Parameter	Test conditions	Min.	Typ.	Max.	Unit
V_{BR}	Breakdown voltage	$I_R = 1\text{ mA}$	6			V
I_{RM}	Leakage current	$V_{RM} = 3\text{ V}$			100	nA
V_{CL}	Clamping voltage	IEC 61000-4-2, +8 kV contact ($I_{PP} = 30\text{ A}$), measured at 30 ns		18		V
$C_{I/O - GND}$	Capacitance (input/output to ground)	$V_{I/O} = 0\text{ V}$, $F = 200\text{ to }3000\text{ MHz}$, $V_{OSC} = 30\text{ mV}$		0.6	0.9	pF
$\Delta C_{I/O - GND}$	Capacitance variation (input/output to ground)	$V_{I/O} = 0\text{ V}$, $F = 200\text{ to }3000\text{ MHz}$, $V_{OSC} = 30\text{ mV}$		0.09	0.17	pF
f_C	Cut-off frequency	-3 dB		4.6		GHz

Figure 2. Leakage current versus junction temperature (typical values)

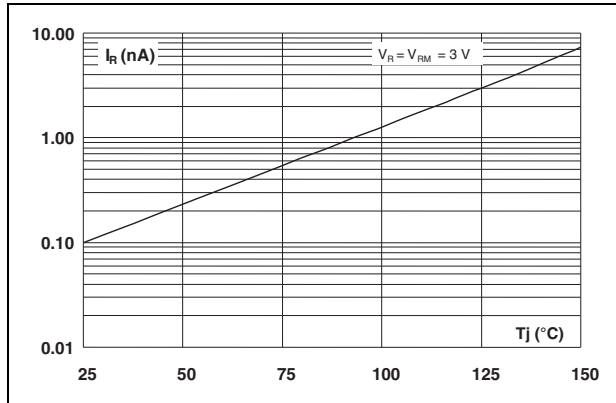

Figure 3. S21 attenuation measurement

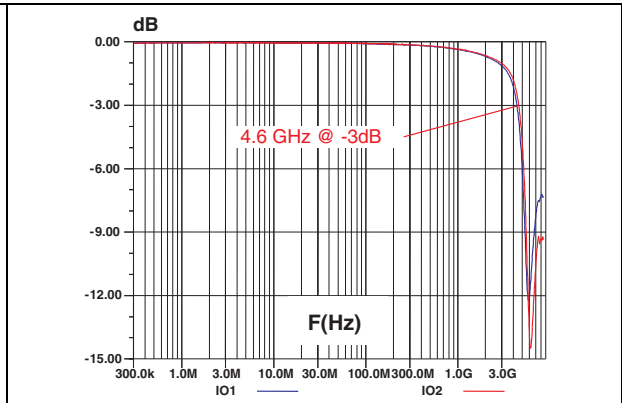

Figure 4. Eye diagram - HDMI mask at 3.4 Gbps per channel⁽¹⁾ (HSP062-2M6)

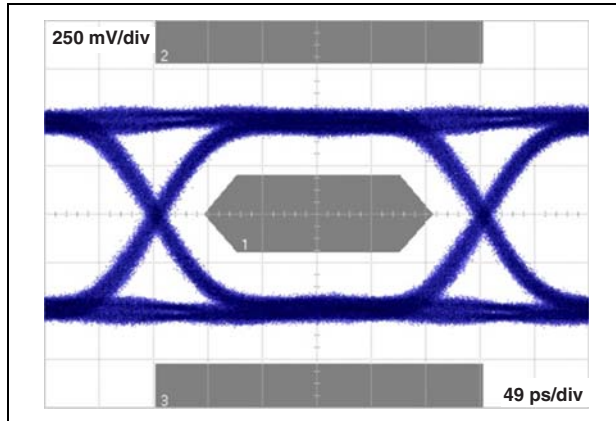
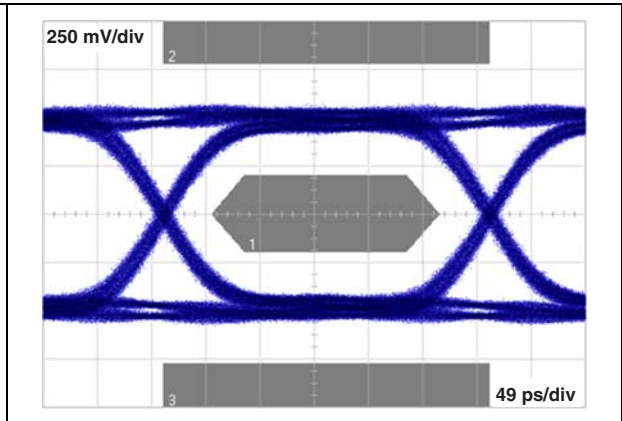

Figure 5. Eye diagram - HDMI mask at 3.4 Gbps per channel⁽¹⁾ (HSP062-2P6)



1. HDMI specification conditions. This information can be provided for other applications. Please contact your local ST office.

Figure 6. ESD response to IEC 61000-4-2 (+8 kV contact discharge)

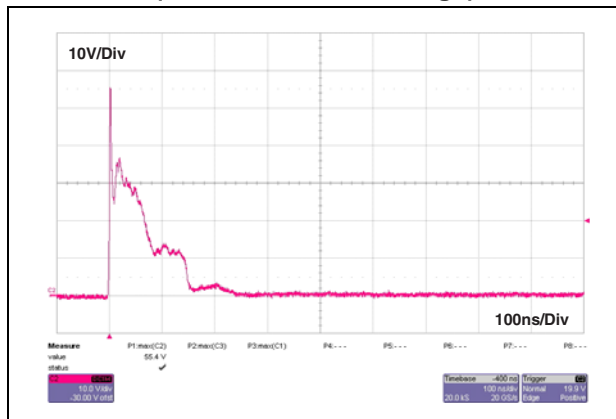
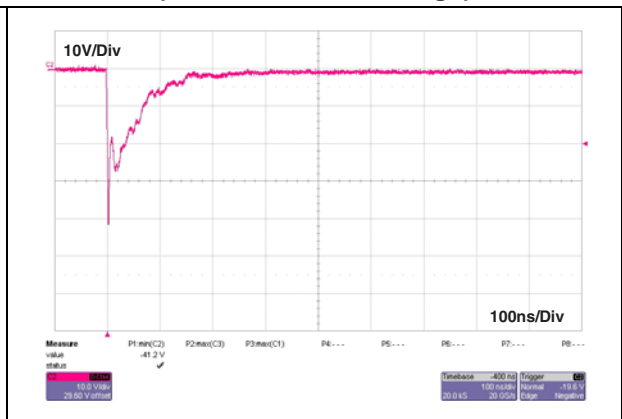
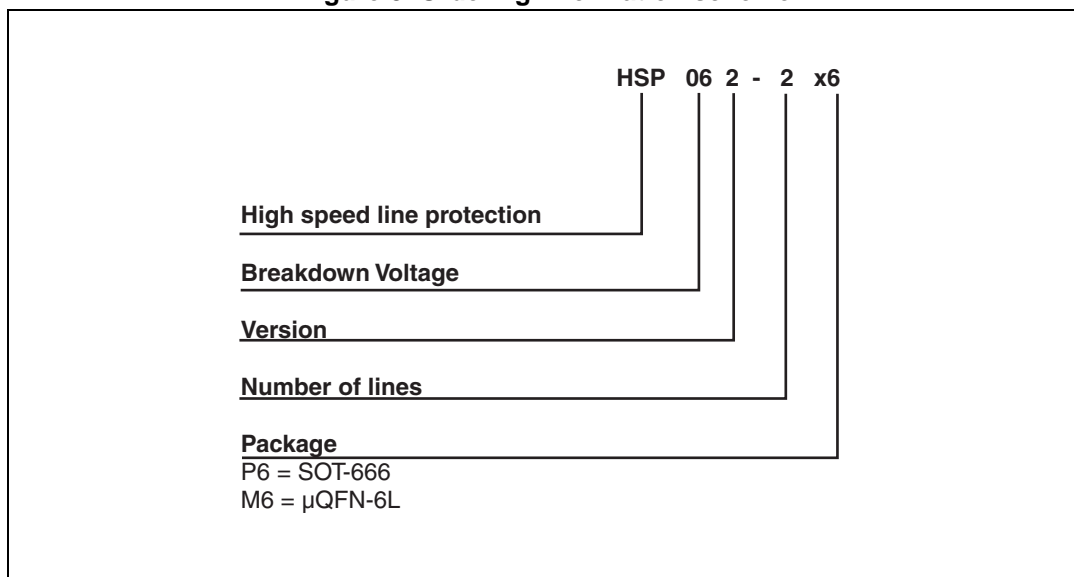

Figure 7. ESD response to IEC 61000-4-2 (-8 kV contact discharge)



2 Ordering information scheme

Figure 8. Ordering information scheme



3 Package information

- Epoxy meets UL94, V0
- Lead-free package

In order to meet environmental requirements, ST offers these devices in different grades of ECOPACK® packages, depending on their level of environmental compliance. ECOPACK® specifications, grade definitions and product status are available at: www.st.com. ECOPACK® is an ST trademark.

Table 3. SOT-666 dimensions

Ref.	Dimensions					
	Millimeters			Inches		
	Min.	Typ.	Max.	Min.	Typ.	Max.
A	0.45		0.60	0.018		0.024
A3	0.08		0.18	0.003		0.007
b	0.17		0.34	0.007		0.013
b1	0.19	0.27	0.34	0.007	0.011	0.013
D	1.50		1.70	0.059		0.067
E	1.50		1.70	0.059		0.067
E1	1.10		1.30	0.043		0.051
e		0.50			0.020	
L1		0.19			0.007	
L2	0.10		0.30	0.004		0.012
L3		0.10			0.004	

Figure 9. Footprint recommendations dimensions in mm (inches)

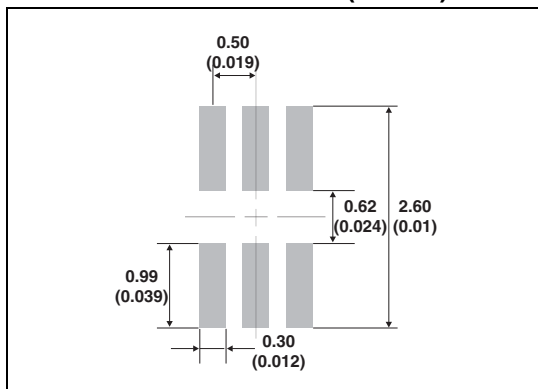

Figure 10. Marking for SOT-666

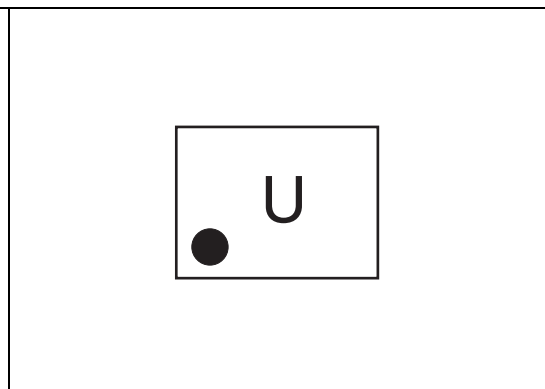

Table 4. Micro QFN 1.45x1.00 6L dimensions

Ref.	Dimensions					
	Millimeters			Inches		
	Min.	Typ.	Max.	Min.	Typ.	Max.
A	0.50	0.55	0.60	0.020	0.022	0.024
A1	0.00	0.02	0.05	0.000	0.001	0.002
b	0.18	0.25	0.30	0.007	0.010	0.012
D		1.45			0.057	
E		1.00			0.039	
e		0.50			0.020	
K	0.20			0.008		
L	0.30	0.35	0.40	0.012	0.014	0.016

Figure 11. Footprint recommendations dimensions in mm (inches)

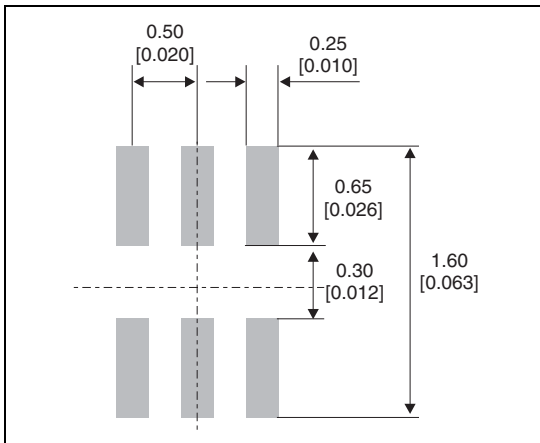
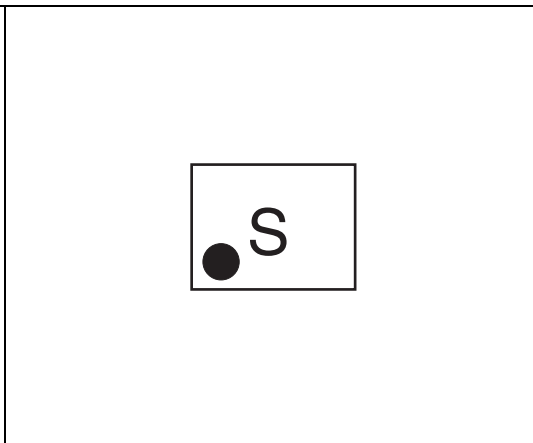

Figure 12. Marking for Micro QFN 1.45x1.00 6L



Note: Product marking may be rotated by 90° for assembly plant differentiation. In no case should this product marking be used to orient the component for its placement on a PCB. Only pin 1 mark is to be used for this purpose.

4 Recommendation on PCB assembly

4.1 Stencil opening design

1. General recommendation on stencil opening design
 - a) Stencil opening dimensions: L (Length), W (Width), T (Thickness).

Figure 13. Stencil opening dimensions

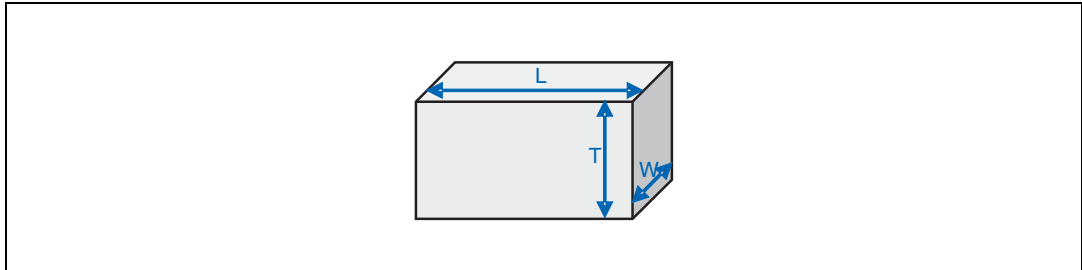

- b) General design rule
 - Stencil thickness (T) = 75 ~ 125 μm
 - Aspect Ratio = $\frac{W}{T} \geq 1.5$
 - Aspect Area = $\frac{L \times W}{2T(L + W)} \geq 0.66$

2. Reference design
 - a) Stencil opening thickness: 100 μm
 - b) Stencil opening for leads: Opening to footprint ratio is 90%.

Figure 14. Recommended stencil window position

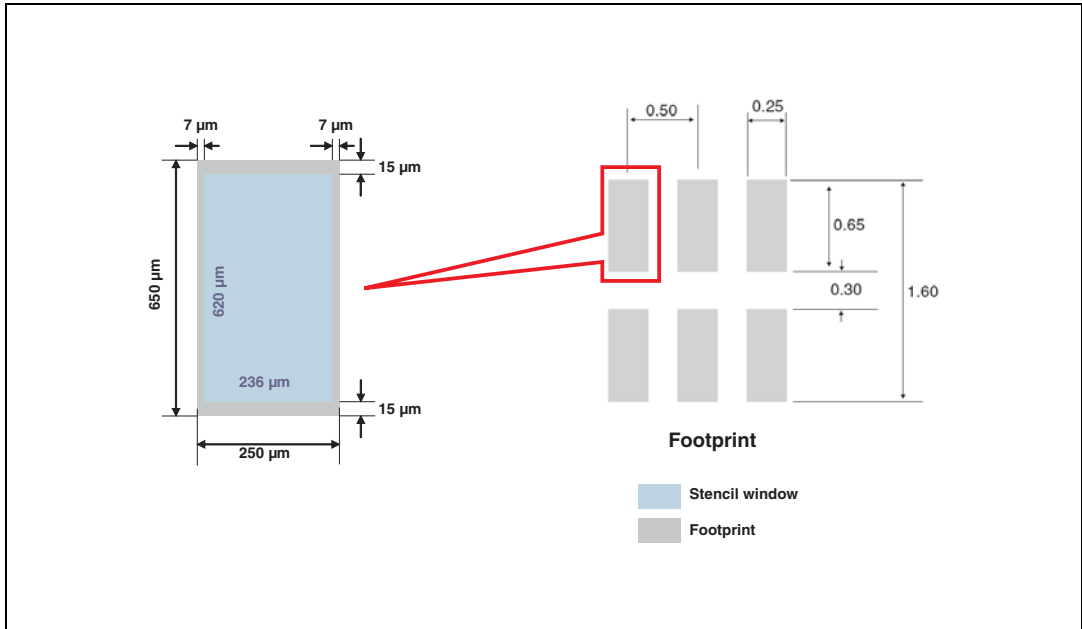

4.2 Solder paste

1. Halide-free flux qualification ROL0 according to ANSI/J-STD-004.
2. “No clean” solder paste is recommended.
3. Offers a high tack force to resist component movement during high speed.
4. Solder paste with fine particles: powder particle size is 20-45 μm .

4.3 Placement

1. Manual positioning is not recommended.
2. It is recommended to use the lead recognition capabilities of the placement system, not the outline centering.
3. Standard tolerance of ± 0.05 mm is recommended.
4. 3.5 N placement force is recommended. Too much placement force can lead to squeezed out solder paste and cause solder joints to short. Too low placement force can lead to insufficient contact between package and solder paste that could cause open solder joints or badly centered packages.
5. To improve the package placement accuracy, a bottom side optical control should be performed with a high resolution tool.
6. For assembly, a perfect supporting of the PCB (all the more on flexible PCB) is recommended during solder paste printing, pick and place and reflow soldering by using optimized tools.

4.4 PCB design preference

1. To control the solder paste amount, the closed via is recommended instead of open vias.
2. The position of tracks and open vias in the solder area should be well balanced. The symmetrical layout is recommended, in case any tilt phenomena caused by asymmetrical solder paste amount due to the solder flow away.

4.5 Reflow profile

Figure 15. ST ECOPACK® recommended soldering reflow profile for PCB mounting

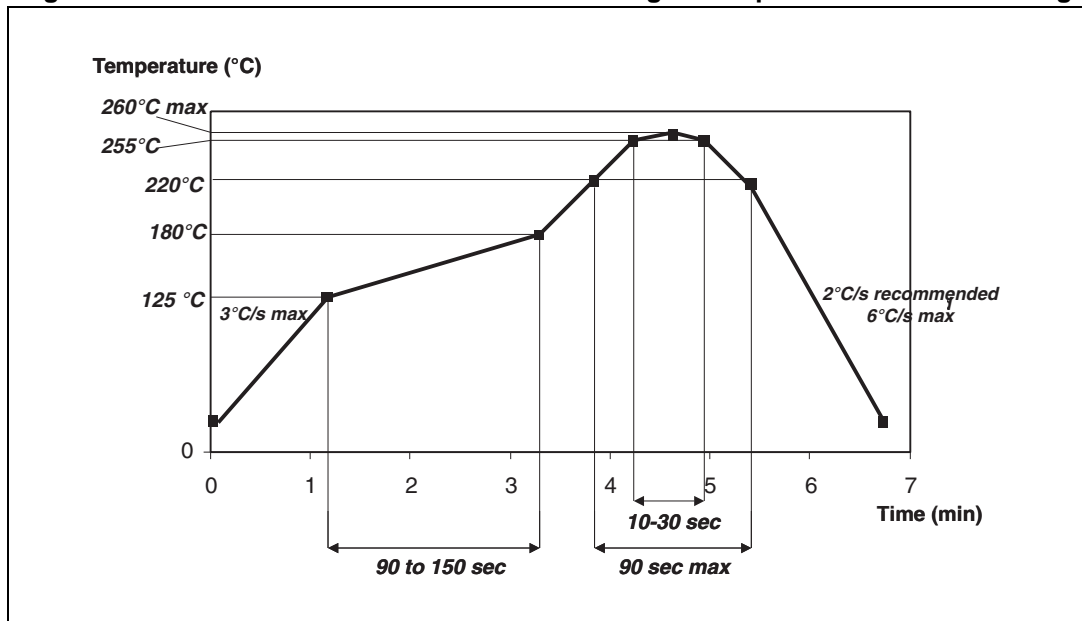

Note: Minimize air convection currents in the reflow oven to avoid component movement.

5 Ordering information

Table 5. Ordering information

Order code	Marking	Package	Weight	Base qty	Delivery mode
HSP062-2P6	U	SOT-666	2.85 mg	3000	Tape and reel (7")
HSP062-2M6	S ⁽¹⁾	μQFN-6L	2.3 mg	3000	Tape and reel (7")

1. The marking can be rotated by multiple of 90° to differentiate assembly location

6 Revision history

Table 6. Document revision history

Date	Revision	Changes
07-Feb-2012	1	Initial release.
19-Mar-2014	2	Minor text changes.

Please Read Carefully:

Information in this document is provided solely in connection with ST products. STMicroelectronics NV and its subsidiaries ("ST") reserve the right to make changes, corrections, modifications or improvements, to this document, and the products and services described herein at any time, without notice.

All ST products are sold pursuant to ST's terms and conditions of sale.

Purchasers are solely responsible for the choice, selection and use of the ST products and services described herein, and ST assumes no liability whatsoever relating to the choice, selection or use of the ST products and services described herein.

No license, express or implied, by estoppel or otherwise, to any intellectual property rights is granted under this document. If any part of this document refers to any third party products or services it shall not be deemed a license grant by ST for the use of such third party products or services, or any intellectual property contained therein or considered as a warranty covering the use in any manner whatsoever of such third party products or services or any intellectual property contained therein.

UNLESS OTHERWISE SET FORTH IN ST'S TERMS AND CONDITIONS OF SALE ST DISCLAIMS ANY EXPRESS OR IMPLIED WARRANTY WITH RESPECT TO THE USE AND/OR SALE OF ST PRODUCTS INCLUDING WITHOUT LIMITATION IMPLIED WARRANTIES OF MERCHANTABILITY, FITNESS FOR A PARTICULAR PURPOSE (AND THEIR EQUIVALENTS UNDER THE LAWS OF ANY JURISDICTION), OR INFRINGEMENT OF ANY PATENT, COPYRIGHT OR OTHER INTELLECTUAL PROPERTY RIGHT.

ST PRODUCTS ARE NOT DESIGNED OR AUTHORIZED FOR USE IN: (A) SAFETY CRITICAL APPLICATIONS SUCH AS LIFE SUPPORTING, ACTIVE IMPLANTED DEVICES OR SYSTEMS WITH PRODUCT FUNCTIONAL SAFETY REQUIREMENTS; (B) AERONAUTIC APPLICATIONS; (C) AUTOMOTIVE APPLICATIONS OR ENVIRONMENTS, AND/OR (D) AEROSPACE APPLICATIONS OR ENVIRONMENTS. WHERE ST PRODUCTS ARE NOT DESIGNED FOR SUCH USE, THE PURCHASER SHALL USE PRODUCTS AT PURCHASER'S SOLE RISK, EVEN IF ST HAS BEEN INFORMED IN WRITING OF SUCH USAGE, UNLESS A PRODUCT IS EXPRESSLY DESIGNATED BY ST AS BEING INTENDED FOR "AUTOMOTIVE, AUTOMOTIVE SAFETY OR MEDICAL" INDUSTRY DOMAINS ACCORDING TO ST PRODUCT DESIGN SPECIFICATIONS. PRODUCTS FORMALLY ESCC, QML OR JAN QUALIFIED ARE DEEMED SUITABLE FOR USE IN AEROSPACE BY THE CORRESPONDING GOVERNMENTAL AGENCY.

Resale of ST products with provisions different from the statements and/or technical features set forth in this document shall immediately void any warranty granted by ST for the ST product or service described herein and shall not create or extend in any manner whatsoever, any liability of ST.

ST and the ST logo are trademarks or registered trademarks of ST in various countries.

Information in this document supersedes and replaces all information previously supplied.

The ST logo is a registered trademark of STMicroelectronics. All other names are the property of their respective owners.

© 2014 STMicroelectronics - All rights reserved

STMicroelectronics group of companies

Australia - Belgium - Brazil - Canada - China - Czech Republic - Finland - France - Germany - Hong Kong - India - Israel - Italy - Japan - Malaysia - Malta - Morocco - Philippines - Singapore - Spain - Sweden - Switzerland - United Kingdom - United States of America

www.st.com

