

PLEASE CHECK WWW.MOLEX.COM FOR LATEST PART INFORMATION

Part Number: [19002-0014](#)
Status: **Active**
Description: Avikrimp™ Fully Insulated Quick Disconnect, Female, for 18-22 AWG Wire, Mylar Tape

Documents:

[Drawing \(PDF\)](#) [Product Specification PS-19902-015 \(PDF\)](#)
[Product Specification PS-19902-011 \(PDF\)](#) [RoHS Certificate of Compliance \(PDF\)](#)
[Product Specification PS-19902-014 \(PDF\)](#)

Agency Certification

CSA LR18689
 UL E79133

General

Product Family Quick Disconnects
 Series [19002](#)
 Crimp Quality Equipment Yes
 Insulated Fully
 Product Name Avikrimp™
 Type Quick Disconnect
 UPC 800753027114

Physical

Barrel Type Closed
 Color - Resin Red
 Flammability 94V-2
 Gender Female
 Glow-Wire Compliant No
 Insulation Nylon (PA)
 Lock to Mating Part None
 Material - Metal Brass
 Material - Plating Mating Tin
 Material - Plating Termination Tin
 Net Weight 0.815/g
 Orientation Straight
 Packaging Type Adhesive Tape on Reel
 Plating min - Mating 4.064µm
 Plating min - Termination 4.064µm
 Polarized to Mating Part No
 Tab Thickness 0.51mm
 Tab Width 2.79mm
 Temperature Range - Operating -65°C to +105°C
 Termination Interface: Style Crimp or Compression
 Wire Insulation Diameter 3.17mm max.
 Wire Size AWG 18, 20, 22
 Wire Size mm² 0.35 - 0.80

Electrical

Voltage - Maximum 300V

Material Info

Old Part Number AA-5275T

Reference - Drawing Numbers

Product Specification PS-19902-011, PS-19902-014, PS-19902-015
 Sales Drawing SD-19002-003

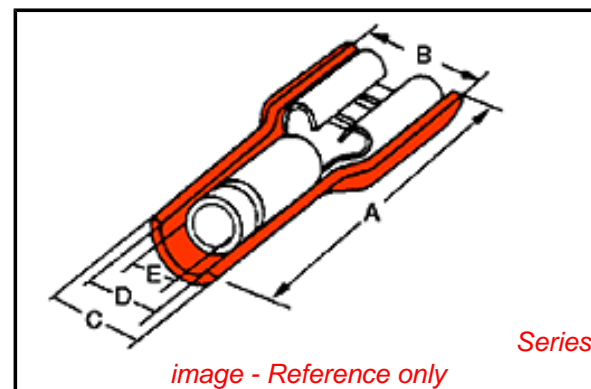

EU RoHS

ELV and RoHS Compliant
REACH SVHC Contains SVHC: No
Low-Halogen Status Low-Halogen

China RoHS



Need more information on product environmental compliance?

Email productcompliance@molex.com
 For a multiple part number RoHS Certificate of Compliance, [click here](#)

Please visit the [Contact Us](#) section for any non-product compliance questions.

Search Parts in this Series

19002Series

Application Tooling | FAQ

Tooling specifications and manuals are found by selecting the products below. Crimp Height Specifications are then contained in the Application Tooling Specification document.

Global

Description	Product #
ATP Perishable	0192880028
Tool Kit used in ATP Presses that Process Product on Tape	
Mini-Mac™ Applicator	0638852000

This document was generated on 07/07/2014

PLEASE CHECK WWW.MOLEX.COM FOR LATEST PART INFORMATION