

evOLUTION®

www.evolutionpowertools.com



Registered Design, Patent Pending 1101605.2.

GEN2800 / GEN2800PUK / GEN2800BEU GENERATOR

ORIGINAL MANUAL

Please read instructions before operating this tool

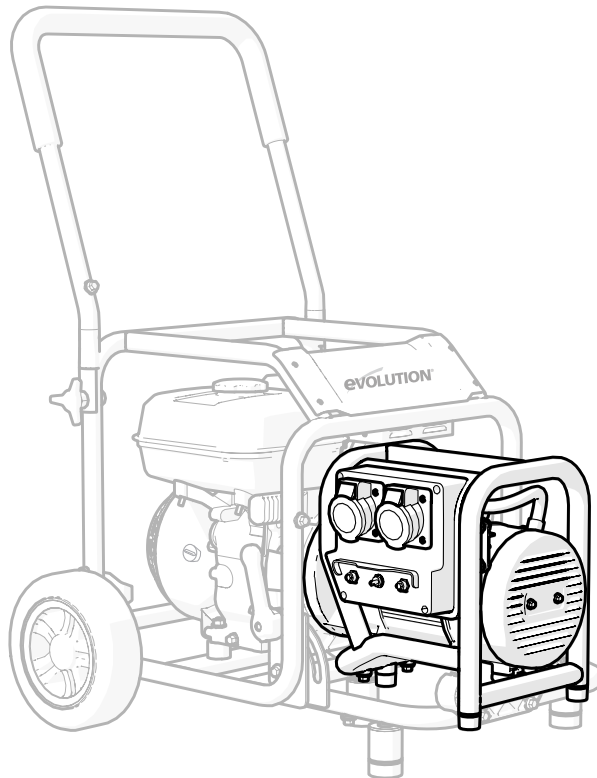

* Generic images shown to illustrate the Evo-System's functionality.
Engine and outputs may vary according to market destination.

CZ

DA

DE

EL

ES

FI

FR

GB

IT

NL

NO

PL

PT

RU

SK

SV

CONNECT OUTPUT

QUICK REFERENCE GUIDE

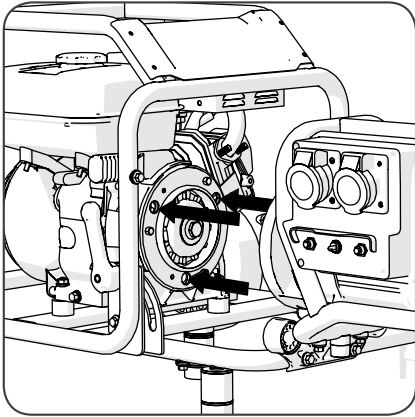

STEP 1...
LINE-UP 3 LOCATING PINS.
AS ARROWS INDICATE

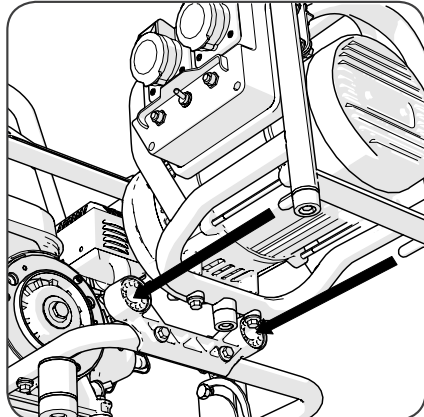

STEP 2...
LINE-UP 2 REAR STABILISER PINS.
AS ARROWS INDICATE

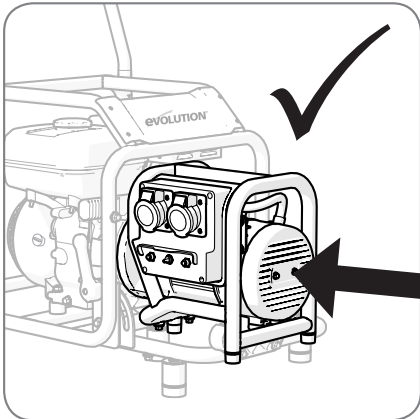

STEP 3...
APPLY GENTLE HORIZONTAL PRESSURE
WITH AN OPEN-HANDED FLAT-PALM.
AS ARROW INDICATES AND LOCK-IN

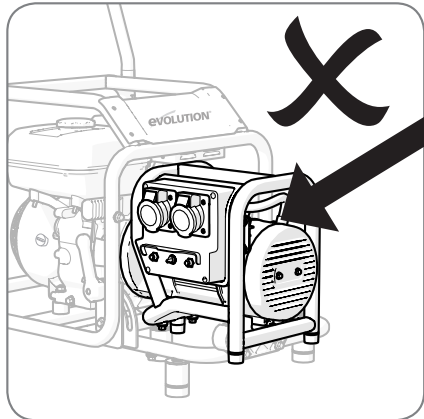

DO NOT...
APPLY SEVERE DIAGONAL DOWN-WARD
PRESSURE AS ARROW INDICATES. DOING
SO MAY DAMAGE THE EVO-SYSTEM!



SEEING IS BELIEVING!

Download a FREE QR READER APP
and scan the QR CODE (below).

Instantly watch the **HD Evo-System Video** on your Smart Phone.

Make sure the HD setting is on.

If you don't have a Smart Phone, you can also watch all Evolution's videos online.



CZ

DA

DE

EL

ES

FI

FR

GB

IT

NL

NO

PL

PT

RU

SK

SV

TABLE OF CONTENTS

EC - Declaration of Conformity	118
Important Information	119
12 Month Limited Warranty	119
General Safety Rules	119
Engine Driven Generator	121
Additional Specific Safety Rules	121
Symbols & Labels	122
Specification	122
Generator Application	123
Machine Overview	124
Assembly	126
Operation	127
Maintenance	129
Environmental Protection	129

NOTICE:

A parts diagram can be downloaded from
www.evolutionpowertools.co.uk/evosystem.html

EC - DECLARATION OF CONFORMITY**We, manufacturer and importer**

Evolution Power Tools Ltd.
Venture One
Sheffield
S20 3FR

Declare that the products:

Evolution UK Pro Generator (GEN2800)
Evolution UK DIY Generator (GEN2800PUK)
Evolution EU Generator (GEN2800BEU)

Part numbers:

GEN2800 / GEN2800PUK / GEN2800BEU

Complies with the essential requirements of the following European Directives:

89/336/EEC – EMC Directive
2006/95/EC – Low Voltage Directive
98/37/EEC - Machinery Directive
2000/14/EC – Noise Directive

The following standards have been applied:

EN55014-1:2000/+A1:2001/+A2:2002
EN 55014-2:1997/+A1:2001
EN 61000-3-2:2000/+A2:2005
EN 61000-3-3:1995/+A1:2001
EN 61000-3-11:2000
EN1012-1:1996
EN 60204-1:1997

Authorised by

**Mr Matthew J Gavins**

Managing Director
1 September 2011

All documentation is held on file at the above address and is available, on request for review.

IMPORTANT

Please read these operating and safety instructions carefully and completely. For your own safety if you are uncertain about any aspect of using this equipment, please access our Technical Help Resource.

UK: 0870 609 2297
EMAIL: info@evolutionpowertools.com

EVOLUTION GENERATOR

Congratulations on your purchase of an Evolution Power Tools Evo-System. Please complete your product registration online to validate your machine's warranty period and ensure prompt service if needed. We sincerely thank you for selecting a product from Evolution Power Tools.

12 MONTH LIMITED WARRANTY.

Evolution Power Tools reserves the right to make improvements and modifications to design without prior notice.

Evolution Power Tools will, within twelve (12) months from the original date of purchase, repair or replace any goods found to be defective in materials or workmanship. This warranty is void if the machine being returned has been used beyond the recommendations in the Instruction Manual or if the machine has been damaged by accident, neglect, or improper service. This warranty does not apply to machines and / or components which have been altered, changed, or modified in any way, or subjected to use beyond recommended capacities and specifications. Electrical components are subject to respective manufacturers' warranties. All goods returned defective shall be returned prepaid freight to Evolution Power Tools. Evolution Power Tools reserves the right to optionally repair or replace it with the same or equivalent item. There is no warranty – written or verbal – for consumables. In no event shall Evolution Power Tools be liable for loss or damage resulting directly or indirectly from the use of our merchandise or from any other cause. Evolution Power Tools is not liable for any costs incurred on such goods or consequential damages. No officer, employee or agent of

Evolution Power Tools is authorised to make oral representations of fitness or to waive any of the foregoing terms of sale and none shall be binding on Evolution Power Tools. Questions relating to this limited warranty should be directed to the company's head office, **or call the appropriate Helpline number.**

GENERAL SAFETY RULES

WARNING: Read all instructions. Failure to follow all instructions listed below may result in electric shock, fire and/or serious injury.

SAVE THESE INSTRUCTIONS

1. Work area safety

- a. Keep work area clean and well lit. Cluttered and dark areas invite accidents.**
- b. Do not operate power tools in explosive atmospheres, such as in the presence of flammable liquids, gases or dust.** Power tools create sparks which may ignite the dust or fumes.
- c. Keep children and bystanders away while operating a power tool.** Distractions can cause you to lose control.

2. Electrical safety

- a. Power tool plugs must match the outlet. Never modify the plug in any way.** Do not use any adapter plugs with earthed (grounded) power tools. Unmodified plugs and matching outlets will reduce risk of electric shock.
- b. Avoid body contact with earthed or grounded surfaces such as pipes, radiators, ranges and refrigerators.** There is an increased risk of electric shock if your body is earthed or grounded.
- c. Do not expose power tools to rain or wet conditions.** Water entering a power tool will increase the risk of electric shock.
- d. Do not abuse the cord.** Never use the cord for carrying, pulling or unplugging the power tool. Keep cord away from heat, oil, sharp edges or moving parts. Damaged or entangled cords increase the risk of electric shock.
- e. When operating a power tool outdoors, use an extension cord suitable for outdoor use.** Use of a cord suitable for outdoor use reduces the risk of electric shock.

f. If operating a power tool in a damp location is unavoidable, use a residual current device (RCD) protected supply. Use of an RCD reduces the risk of electric shock.

3. Personal safety

a. Stay alert, watch what you are doing and use common sense when operating a power tool. Do not use a power tool while you are tired or under the influence of drugs, alcohol or medication. A moment of inattention while operating power tools may result in serious personal injury.

b. Use safety equipment. Always wear eye protection. Safety equipment such as dust mask, non-skid safety shoes, hard hat, or hearing protection used for appropriate conditions will reduce personal injuries.

c. Avoid accidental starting. Ensure the switch is in the off-position before plugging in. Carrying power tools with your finger on the switch or plugging in power tools that have the switch on invites accidents.

d. Remove any adjusting key or spanner before turning the power tool on.

A spanner or a key left attached to a rotating part of the power tool may result in personal injury.

e. Do not overreach. Keep proper footing and balance at all times. This enables better control of the power tool in unexpected situations.

f. Dress properly. Do not wear loose clothing or jewellery. Keep your hair, clothing and gloves away from moving parts. Loose clothes, jewellery or long hair can be caught in moving parts.

g. If devices are provided for the connection of dust extraction and collection facilities, ensure these are connected and properly used. Use of these devices can reduce dust related hazards.

4. Power tool use and care

a. Do not force the power tool. Use the correct power tool for your application. The correct power tool will do the job better and safer when used at the rate for which it was designed.

b. Do not use the power tool if the switch does not turn it on and off. Any power tool that cannot be controlled with the switch is dangerous and must be repaired.

c. Disconnect the plug from the power source before making any adjustments, changing accessories, or storing power tools. Such

preventive safety measures reduce the risk of starting the power tool accidentally.

d. Store idle power tools out of the reach of children and do not allow persons unfamiliar with the power tool or these instructions to operate the power tool. Power tools are dangerous in the hands of untrained users.

e. Maintain power tools. Check for misalignment or binding of moving parts, breakage of parts and any other condition that may affect the power tools operation. If damaged, have the power tool repaired before use. Many accidents are caused by poorly maintained power tools.

f. Keep cutting tools sharp and clean. Properly maintained cutting tools with sharp cutting edges are less likely to bind and are easier to control.

g. Use the power tool, accessories and tool bits etc., in accordance with these instructions and in the manner intended for the particular type of power tool, taking into account the working conditions and the work to be performed. Use of the power tool for operations different from intended could result in a hazardous situation.

5. Service

Have your power tool serviced by a qualified repair person using only genuine replacement parts. This will ensure that the safety of the power tool is properly maintained.

SAFETY INSTRUCTIONS FOR ENGINE DRIVEN GENERATORS

a. Petrol or diesel powered engines must never be used in unventilated closed spaces. The exhaust fumes produced are highly toxic and can cause 'Carbon Monoxide Poisoning' which will cause drowsiness and ultimately death. It is only permissible to run a petrol engine indoors if the building can be very well ventilated and the exhaust fumes can be captured and ducted to the outside through an exhaust extraction/scavenger system.

b. The engine/generator should be positioned on a firm level surface. The wheels should be locked, so that the engine cannot move during operation.

c. The engine should not be run at speeds that exceed the maximum speed on the rating plate. Operating an engine at excessive speeds increases the likelihood of component failure and consequent accidents.

d. Do not tamper with components that regulate the engines speed. You may alter the factory set running parameters.

e. Use only the type of fuel listed in the Engine Instruction Manual. Using fuel with an octane rating less than that specified can lead to excessive engine wear and premature engine failure.

f. Keep the area around the engine clear, clean and tidy. Never allow any combustible material (timber, plastic, cardboard, canvas etc) near a running engine.

g. Do not use in or near to potentially explosive atmospheres. Dust laden atmospheres as can be found in some industrial buildings (Flour Mills, Timber Mills) have an explosive potential.

h. Regularly check the fuel system for leaks. Hoses and unions should be checked for deterioration or chafing. Check the fuel tank for damage or for a poorly fitting or worn fuel cap. Any defects must be rectified before the engine is used.

i. Always stop the engine and allow it to cool down before refuelling. Try to avoid any fuel spillage (often caused by 'overfilling' the tank) and clean up any spilt fuel immediately. The application of dry sand is an effective way of neutralising fuel spills.

j. Do not allow the engine to run out of fuel while a generator under load is attached. Surging of the engine as it uses the last of the fuel could cause damage to connected electrical equipment.

k. When transporting the engine in a vehicle ensure that the fuel tap is turned off. To minimise the risk of fuel spillage the engine should be secured by ropes etc to the load area of the vehicle so that it cannot move during transportation. The engine should be secured in as level an attitude as possible.

l. For long term storage we recommend that the fuel system of the engine is drained. During long term storage additives in modern fuels can precipitate from the fuel and block jets and valves in the fuel system.

m. Store the machine in a secure and well ventilated area. Unauthorised personnel should not have access to this machine.

ADDITIONAL SPECIFIC SAFETY RULES

a. Never use the generator in wet conditions. If using outdoors and rain is a possibility, protect the generator. Observe all safety rules and also ensure that adequate ventilation is maintained.

b. Never operate the generator with wet hands. Risk of electric shock.

c. Never allow the generators air vents to become blocked. There is the risk of fire or damage to the generator if the ventilation is inadequate.

d. Never use water or other liquids to clean the generator. Risk of damage to the generators internal parts from water ingress.

e. Never connect to a commercial or domestic power supply. House ring main.

f. Never allow the engine to run out of fuel or switch off the engine with the generator connected and under load. Risk of damage to connected equipment when the engine surges as it uses the last of the fuel.

g. The applied load must not exceed the generator rating. Overloading the generator can be dangerous and could also cause serious damage to the generator and/or connected appliances.









h. Always ensure that the engine has reached operational temperature and that the generator is running at the required operational speed. Applying a load to a petrol driven generator that is not at full operational efficiency can cause damage to the connected equipment and/or the generator.

i. Only attempt maintenance with the generator disconnected from any load. The engine should be stopped and cold.

j. Observe all safety rules for the operation of the Engine as outlined in the relevant Instruction Manual. Observe particularly the refuelling procedures and safety rules.

WARNING: Do not operate this machine if warning and/or instruction labels are missing or damaged. Contact Evolution Power Tools for replacement labels.

NOTE: All or some of the following symbols may appear in the manual or on the product.

Symbol	Description
V	Volts
A	Amperes
Hz	Hertz
Min ⁻¹	Speed
~	Alternating Current
n ₀	No Load Speed
	Wear Safety Goggles
	Wear Ear Protection
	Wear Dust Protection
	Do Not Touch
	Warning
	Caution: Hot Exhaust Do Not Touch
	Caution: This is a four stroke engine. Fill with petrol only. Do not fill with Diesel oil.
	Allow the motor to cool before opening the fuel cap. The vapour is extremely flammable and may ignite on contact with a hot surface or flames
	Restriction of Hazardous Substances Directive
	Waste electrical and electronic equipment
CE	CE certification

SPECIFICATION

UK (PROFESSIONAL) GENERATOR (GEN2800):

Type: Self-Exciting, 2-pole Rotating Field Type

AC/DC: AC Output

Voltage: 110V/230V Switchable

Power Rating (Continuous)50Hz: 2.4kw

Power Rating (Max) 50Hz: 2.8kw

Weight: 20.1kg

UK (DIY) GENERATOR (GEN2800PUK):

Type: Self-Exciting, 2-pole Rotating Field Type

AC/DC: AC Output

Voltage: 230V

Power Rating (Continuous)50Hz: 2.4kw

Power Rating (Max) 50Hz: 2.8kw

Weight: 20.1kg

EURO GENERATOR (GEN2800BEU):

Type: Self-Exciting, 2-pole Rotating Field Type

AC/DC: AC Output

Voltage: 230V

Power Rating (Continuous)50Hz: 2.4kw

Power Rating (Max) 50Hz: 2.8kw

Weight: 20.1kg

Advice on Generator Application

The Evolution Generator is suitable for powering appliances up to a maximum load of 2400W (the Continuous Power Rating of the Generator). The generator is a self exciting 2 pole generator, designed to operate with single phase loads at or near a power factor of 1.0.

Some appliances that contain timing devices or speed sensitive motors etc, may not be suitable for connection to a generator. Computers, laptops, LCD televisions and any similar sensitive electronic devices should not be connected to this generator.

The operator should always consult the appliance handbook to determine the suitability of any particular appliance.

If using the generator to provide power for a motor home, caravan, boat etc always refer to the manufacturers manual regarding the suitability of a generator for such an application.

Do not connect this generator into a house ring main.

Do not allow bystanders or children to have access to the generator or any cables to or from the generator and connected appliances. Keep all animals and pets etc away from the generator and connected appliances.

Caution: The operator must ensure that the power requirement of any appliance(s) to be connected does not exceed the maximum continuous rating of the generator as found on the machines rating plate.

Any device which contains an inductive load (i.e. appliances that contain a motor, capacitors, fluorescent light fittings etc.) may draw additional current (to that specified on the machines rating plate). The diagram below indicates a voltage spike induced by the 'start-up' of a motor.

Voltage Spike

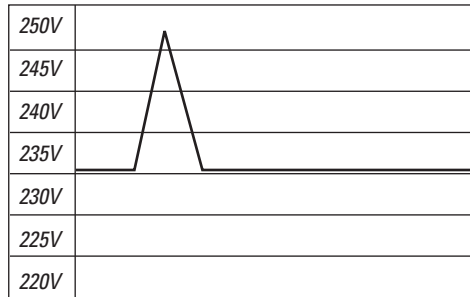

Time

Note: A voltage spike could typically last for approximately 1/20th of a second on start up of a motor driven machine.

Some electrical equipment may have the Power Factor listed on the Rating Label.

The Power Factor may be regarded as a measure of electrical efficiency of the device. The Power Factor scale varies from 0 to 1, with 0.1 equalling 10% efficiency, 0.2 equalling 20% efficiency etc. A Power Factor of 1 would mean the device has an efficiency of 100%.

The Power Factor of such devices should be taken into account when assessing their suitability for connection to the generator. If in doubt contact the appropriate Technical Help Resource.

Machine Overview

General view of Generator connected to the engine unit.

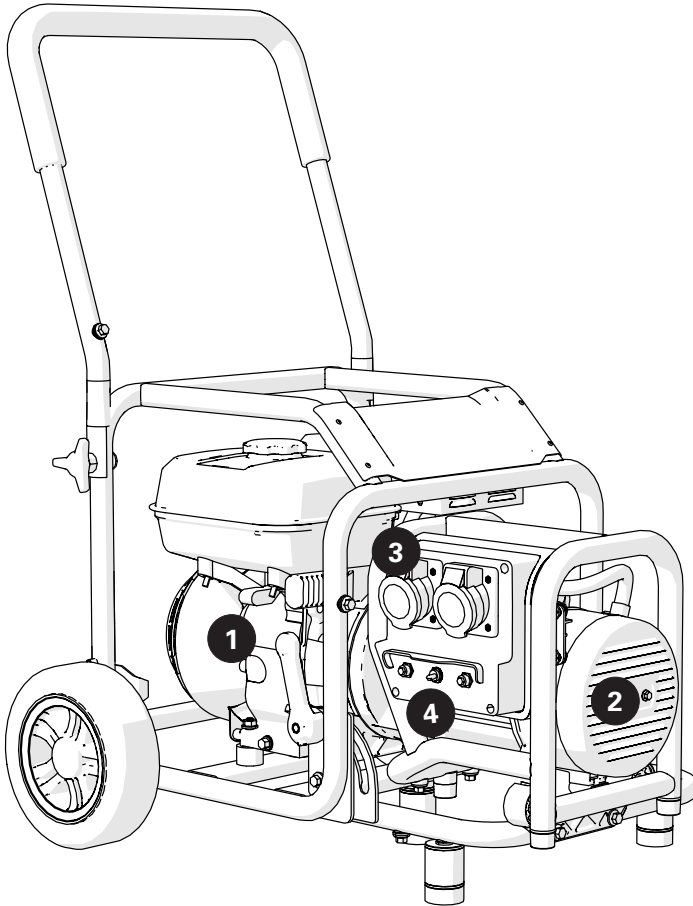

1. Evo-System Engine

2. Generator

3. Socket Outlets
(approved type for intended market)

4. Circuit Breaker Reset Button(s)
(some models also 110V/230V
Selector switch)

Machine Overview

General view of Generator connected to the engine unit.

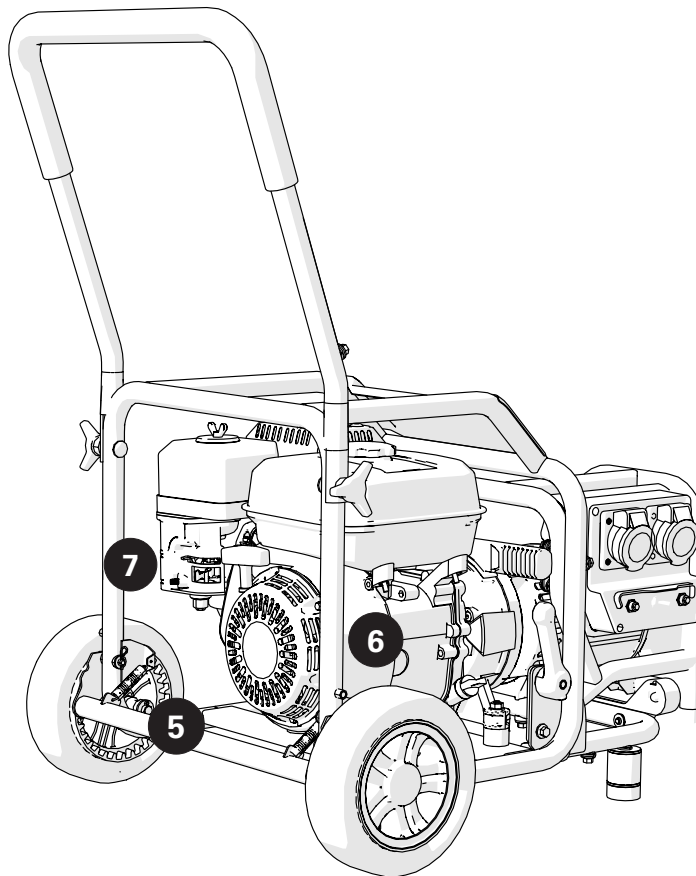

5. Foot brake

6. Engine On/Off switch

7. Fuel tap switch

* Generic images shown to illustrate the Evo-System's functionality.
Engine and outputs may vary according to market destination.

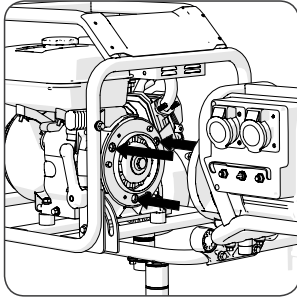

Fig. 1a (showing locating pins)

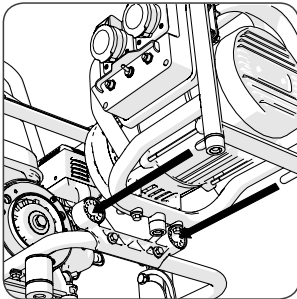

Fig. 1b (showing rear stabiliser pins)

ASSEMBLY

CONNECTING THE GENERATOR TO THE ENGINE UNIT

Note: Your Evolution Generator is designed to be connected to and powered by the Evolution Evo-System Engine. Do not try to connect this machine to any other power source.

Your Evolution Evo-System Engine has a unique coupling that enables a variety of Evolution accessories to be connected to and be driven by this machine. This coupling is engineered to very fine tolerances and must be kept clean and free from dirt, debris etc.

A cover for coupling protection is provided with each accessory and should be used whenever the accessory is 'remote' from the engine.

If you experience difficulty in accessory connection, it could be because the accessory location pins, or the annuli of either the accessory or the engine are contaminated or damaged.

Preparing the engine for accessory connection:

Note: The Evolution Evo-System Engine has a micro switch incorporated within the coupling design that senses when an accessory has been successfully attached to the machine. The engine will not start without an accessory being successfully connected. It cannot be run as a 'stand alone' machine.

- Lock the Transportation Wheels using the wheel brake.
- Release the Accessory Mounting Frame by rotating the locking levers to their unlocked (down) position.
- Deploy the Accessory Mounting Frame to fully down position.
- Lock the frame into position by returning the locking levers to their locked (upright) position.

Generator connection

Note: The Generator is equipped with 3 locating pins and 2 rear stabilising pins. The 3 locating pins lock into the 'Uni-coupling'. The other 2 stabilising pins slide into the sockets in the Accessory Mounting Frame.

- Hold the accessory by its external frame and offer it up to the engine. Visually align the 3 locating pins (**Fig.1a**) and 2 rear stabilising pins (**Fig.1b**). Enlist competent help if necessary.

- Holding onto a convenient part of the external engine frame can aid the operator achieving and maintaining alignment when connecting an accessory.
- Gently push the accessory into the engine. Keep the 3 locating pins and the 2 stabilising pins aligned with their respective docking positions. The internal coupling between the engine and the accessory will be made automatically. No component alignment or adjustments are necessary.
- Be gentle and patient, the coupling is precisely engineered and no great force is required to connect the accessories. Once the operator has mastered the 'technique', accessory connection will become straight forward.
- Firmly push the engine and accessory together until the 'click' of docking is heard. The Uni-coupling release lever will return to its neutral position.

OPERATION

Initial preparation

WARNING: This is a very powerful piece of equipment. All safety rules and advice must be heeded. Failure to use this equipment correctly could result in serious injury to the operator or others.

1. Siting the Equipment

Note: The Evolution Evo-System Engine with the generator attached should be sited with reference to the instructions given in the Engine Instruction Manual (SAFETY INSTRUCTIONS FOR EVO-SYSTEM ENGINE).

Site the equipment and check:

- The equipment is as level as possible.
- The wheel brake is applied.
- The surface is firm and stable.
- No combustible materials are close by.
- The area is well ventilated, and that there is no danger from the expelled exhaust gases.

Note: The Evo-System Engine is fitted with a low oil level shut down feature which protects the engine from damage due to lack of lubrication. This feature could be activated if the machine is sited on a slope of greater than 10°.

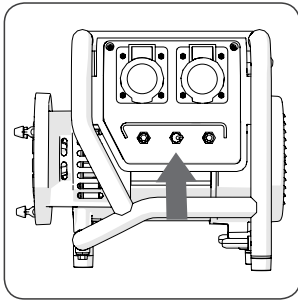

Fig. 2 (UK Professional version shown)

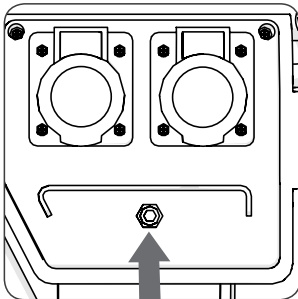

Fig. 3 (Euro version shown)

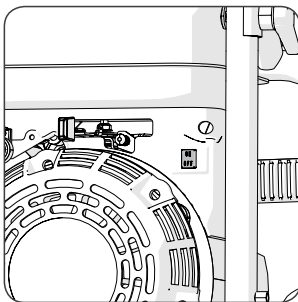

Fig. 4

2. Preparing the Evo-System Engine

Note: Refer to the Instruction Manual for the Evolution Evo-System Engine.

- Check the Fuel Level.
- Check the Oil Level.
- Visually check all fuel lines and electrical connections.

3. Starting the Engine

Note: Refer to the Instruction Manual for the Evo-System Engine

- Start the engine.
- Allow the engine to reach its normal operational temperature.

4. Connecting Electrical Appliances

Note: For some markets the generator can supply either 230V AC or 110V AC.

- If applicable select the voltage required by setting the selection switch to 230V or 110V. **(Fig. 2)**
- Ensure that the appliance cable is undamaged and has the correct plug fitted.
- Route the cable so that it does not pose a trip, or any other hazard.
- The engine and generator must be at full operational temperature before any appliance is connected.
- Ensure that the appliance 'ON/OFF' switch is in the 'OFF' position before connection is attempted.
- Open the required plug outlet and make the connection.

Note: Each outlet socket is protected by an overload protection device. If the overload protector activates, wait a few minutes and then press the reset button. **(Fig. 3)** Check the power rating of the attached devices.

5. Shutting Down

To shut down and turn off the generator:

- Switch off and disconnect all appliances that are connected to the generator.
- Turn the engine ignition switch to the 'OFF' position. **(Fig. 4)**
- Turn the fuel tap to the 'OFF' position. **(Fig. 5)**

Note: In an emergency situation the generator can be shut down by turning the ignition switch to the 'OFF' position. This is not advised in general use as it can damage the device if repeated often.

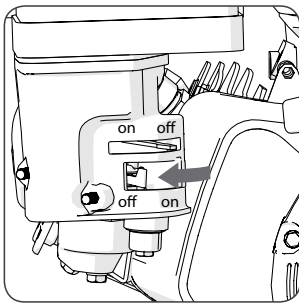

Fig. 5

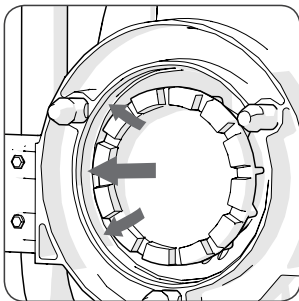

Fig. 6

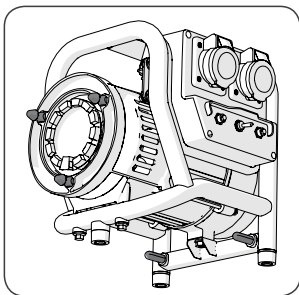

Fig. 7

MAINTENANCE

Note: The maintenance schedule for the Evo-System Engine can be found in the dedicated Instruction Manual.

Generator

- Keep the generator clean and regularly check the tightness of all bolts and fastenings.
- Keep the annular rings scrupulously clean and free from debris (Engine & Accessory). **(Fig. 6)**
- Keep the 3 locating pins and 2 stabilising pins clean and occasionally spray coat with a silicone oil based spray. **(Fig. 7)**
- Keep all Uni-coupling mating surfaces clean and free from dirt or debris.
- At every connection or disconnection check the accessory drive cog for dirt or debris contamination, particularly between the teeth. Clean and lubricate as per the instructions for the engine drive clutch (found in the Engine Instruction Manual).
- Whenever the accessory is 'remote' from the engine the coupling protection cover (provided) should be used to protect the coupling.
- Do not spray oil onto the cog teeth.

ENVIRONMENTAL PROTECTION

Waste electrical and mechanical products should not be disposed of with household waste. Please recycle where facilities exist. Check with your Local Authority or retailer for recycling advice

DID YOU KNOW YOU CAN ALSO BUY...

ENGINE UNIT

- ✓ Wheel kit provides mobility.
- ✓ Folding handle for storage.
- ✓ Robust & durable steel frame.

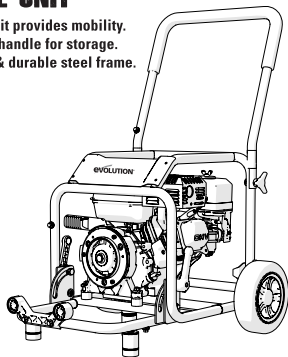

EVO-SYSTEM ENGINE

WATER PUMP

- ✓ Pumps 1000L per minute.
- ✓ Inlet filter prevents unwanted debris from entering the pump.

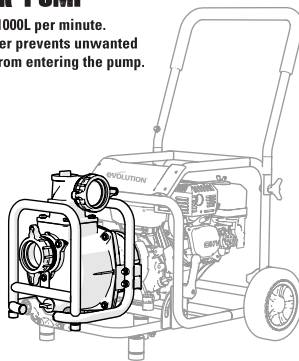

WATER PUMP OUTPUT

PRESSURE WASHER

- ✓ High quality brass pump.
- ✓ Includes lance with adjustable nozzle & hose.
- ✓ Built-in detergent system.

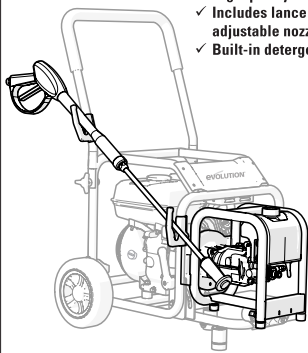

PRESSURE WASHER OUTPUT

GENERATOR

- ✓ Switchable voltages.
- ✓ Thermal cut-outs.
- ✓ Automatic voltage regulation.

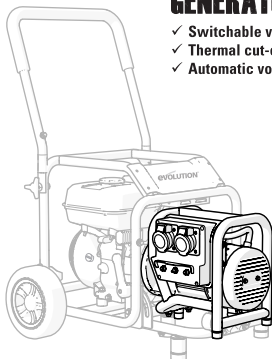

GENERATOR OUTPUT



Registered Design. Patent Pending 1101605.2.

...WITH MORE OUTPUTS AVAILABLE SOON!