

PLEASE CHECK WWW.MOLEX.COM FOR LATEST PART INFORMATION

Part Number: [39-30-1039](#)
Status: **Active**
Overview: [Mini-Fit Jr.™ Power Connectors](#)
Description: Mini-Fit® Jr. Header, Dual Row, Vertical, with Snap-in Plastic Peg PCB Lock, 3 Circuits, PA Polyamide Nylon 6/6, UL 94V-2, Tin (Sn) Plating, without Drain Holes

Documents:

[3D Model](#) [Test Summary TS-5556-002 \(PDF\)](#)
[Drawing \(PDF\)](#) [RoHS Certificate of Compliance \(PDF\)](#)
[Product Specification PS-5556-001 \(PDF\)](#)

Agency Certification

CSA LR19980
 UL E29179

General

Product Family PCB Headers
 Series [5566](#)
 Application Power, Wire-to-Board
 Comments The 5566 header should be used with standard Mini-Fit® female terminals. If increased amperage of up to 13A per circuit is needed, please consider using the Mini-Fit® Plus HCS family [45750](#) terminals with [46014](#) headers; . See Molex Product specification for current de-rating information.
 Overview [Mini-Fit Jr.™ Power Connectors](#)
 Product Name Mini-Fit Jr.™
 UPC 800753580107

Physical

Breakaway No
 Circuits (Loaded) 3
 Circuits (maximum) 3
 Color - Resin Natural
 Durability (mating cycles max) 30
 First Mate / Last Break No
 Flammability 94V-2
 Glow-Wire Compliant No
 Guide to Mating Part No
 Keying to Mating Part None
 Lock to Mating Part Yes
 Material - Metal Brass
 Material - Plating Mating Tin
 Material - Plating Termination Tin
 Material - Resin Nylon
 Net Weight 0.801/g
 Number of Rows 1
 Orientation Vertical
 PC Tail Length 3.50mm
 PCB Locator Yes
 PCB Retention Yes
 PCB Thickness - Recommended 1.60mm
 Packaging Type Tray
 Pitch - Mating Interface 4.20mm
 Pitch - Termination Interface 4.20mm
 Polarized to Mating Part Yes

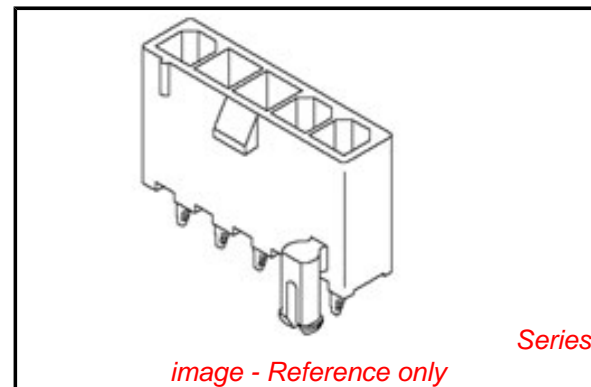

EU RoHS

ELV and RoHS Compliant
REACH SVHC Contains SVHC: No
Low-Halogen Status Low-Halogen

China RoHS



Need more information on product environmental compliance?

Email productcompliance@molex.com
 For a multiple part number RoHS Certificate of Compliance, [click here](#)

Please visit the [Contact Us](#) section for any non-product compliance questions.

Search Parts in this Series

[5566Series](#)

Mates With

[5557 Mini-Fit Jr.™ Receptacle Housing](#)

Polarized to PCB	Yes
Shrouded	Fully
Stackable	No
Surface Mount Compatible (SMC)	No
Temperature Range - Operating	-40°C to +105°C
Termination Interface: Style	Through Hole

Electrical

Current - Maximum per Contact	9A
Voltage - Maximum	600V

Solder Process Data

Duration at Max. Process Temperature (seconds)	5
Lead-free Process Capability	Wave Capable (TH only)
Max. Cycles at Max. Process Temperature	1
Process Temperature max. C	240

Material Info

Old Part Number	A-5566-03A3
-----------------	-------------

Reference - Drawing Numbers

Product Specification	PS-5556-001
Sales Drawing	SDA-5566-03*3*
Test Summary	TS-5556-002

This document was generated on 07/09/2014

PLEASE CHECK WWW.MOLEX.COM FOR LATEST PART INFORMATION