

# 2000

Series controllers



imagine making the  
impossible possible

# Ultimate performance

Simply **imagine** process excellence... and with Eurotherm you will achieve it. Our ranges of controllers provide world class control and versatility with clear, user friendly, operator interfaces. Add to this, a strong sales team of qualified engineers who understand your process, an absolute commitment to innovation by continuously re-investing in research and development; we can and do **imagine** making the impossible possible for our customers.

Built on our experience of design and applications knowledge spanning more than 40 years, the Eurotherm® 2000 series brings you performance you can rely on and accuracy you can trust.

At the same time no other range of controllers makes operation so easy. Menu driven operation provides easy intuitive and consistent access to all the controller functions.

## Internal timer

- A 5 mode timer suitable for simple time based profiling applications

## Universal input

- 9 different thermocouples, PT100, DC linear and a downloadable custom curve



## Three internal alarms

- Configurable as High, Low, Deviation and Deviation High or Low alarms

## Two outputs

- 1 relay and 1 logic (can be used as a relay with an external module)

Suitable for • Small ovens • Chillers • Sterilisers • Trace heating • Heat sealing •

## Four outputs

- up to 4 outputs including 2 modular with many options including DC outputs

## Communication protocols

- Modbus RTU, El-Bisynch, DeviceNet®



## Dwell timer

- simple ramp dwell profile applications

## Four internal alarms

- configurable as High, Low, Deviation, Deviation High, Deviation Low, High and Low current alarms

Suitable for • Cold stores • Ovens and furnaces • Plastic extrusion • Packaging machines • Food and brewing applications •

imagine process  
excellence...

i n v e n t e r s  
Eurotherm

## Customisable to your control requirements

Every 2000 Series controller can be tailored to provide the control solution you need. Modular design and easy, on-site configuration matches application requirements and gives you a temperature and process control solution that's ready to run the first time you switch it on.

The 2000 Series provides control strategies ranging from simple ON/OFF to PID with advanced overshoot

protection, providing the best control for the widest range of applications including valve positioning. Within the 2000 Series there is also the 2500 Modular Controller and the 2604/2704 Controllers which, with their enhanced functionality and multiloop capability, offer a powerful addition to the range. Please consult Eurotherm sales for more information on these products.

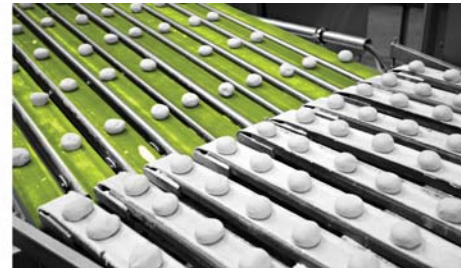

### Modular

- up to 4 outputs of which 3 are modular with many different options within the different modules

### Modules

- up to 16 different types of module are available

### Communication protocols

- Modbus RTU, EI-Bisynch, DeviceNet, Profibus DP



### Programming

- up to 20, 16 segment programs (4 in the 2416) are available with 8 digital event outputs

### Four internal alarms

- configurable as High, Low, Deviation, Deviation High or Low, high and Low Current alarms high and low output, high and low input 2, High and low setpoint and one Rate of change alarm

**Suitable for** • Single and multi-zone furnaces • Kilns • Environmental chambers • Simple ratio • Humidity • Chemical and pharmaceutical • Applications • Glass furnaces and lehrs •

[www.eurotherm.com/2000](http://www.eurotherm.com/2000)

# Success stories commercial benefits

Case Study

## Prompt, accurate flow detection rate and response

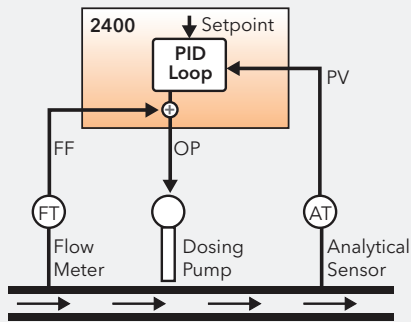

2400 series Feedforward control is excellent for chemical dosing applications

### Customer Challenge

The 2400 process controller is very suitable in the treatment of waste water, petrochemical processes and other additive dosing applications because any possible disturbance to the levels of chemicals added are detected before they can affect the ongoing process.

### Solution

Feedforward is a method for detecting disturbances in the upstream flow and forwarding this information to the controller so that it can change the output before the disturbance affects the downstream ratio.

So, in the diagram shown, the upstream flow rate from the flow meter (FT) forces an immediate change to the output of the controller (OP) and so causes an immediate change in the Dosing Pump speed.

This Feedforward method is ideal for any process that is subject to upstream disturbances. This type of disturbance is invariably found in either liquid or gas systems.

### Customer Benefits

- Feedforward control can avoid the slowness of integral feedback control because the disturbances are measured and accounted for before they have time to affect
- The dosing rate immediately tracks any changes in flow rate and so prevents any possibility of over or under dosing

### Typical use of technology

- Liquid Level - Boiler Drum Level
- Chemical Dosing - Paint Mixing, Brewing,
- Industrial Distillation - Brewing, Petroleum Refineries, Petrochemical, Chemical Plants, and Natural Gas Processing Plants.

Case Study

## Easy to use controllers for greater flexibility

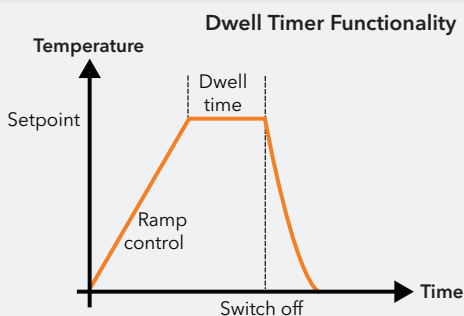

2100 series 5 Mode Timer feature enables cost effective temperature and process control

### Customer Challenges faced in the food beverage industry

Global market forces are driving the continual evolution of the food and beverage industry. Consolidation, changing consumer preferences and increasing government regulations are dramatically impacting manufacturing and business strategy. In this fiercely competitive marketplace, consistent high quality and cost effectiveness are critical to meet consumer demand.

### Solution 2100 Controller

Eurotherm acknowledge these commercial pressures and our products ensure simple cost effective process control. Even one of our simplest, compact controllers has useful cost effective features.

The 5 mode timer in the 2100 temperature process controller may be used to control batch operations, e.g. food production, ovens, sterilisers, fryers. An ideal application would be single dwell at the end of either a controlled ramp rate or natural approach to setpoint without the need for an additional timing device.

### Available Timer Operation Modes are:

- Dwell and Switch Off
- Time from Cold and Switch Off
- Delayed Switch On

### Benefits

- This maintains a target temperature at the end of a ramp rate without the need for an additional device, thereby simplifying the process
- Easy operation with customised interface that presents only the parameters that the operator needs to see. All other parameters can be locked away under password protection.

### Typical use of technology

- Small Ovens, Fryers, Sterilisers, Incubators

Case Study

Highly flexible temperature values

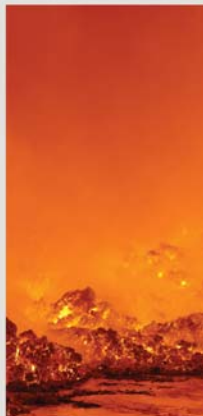

2400 controller 8 segment program, repeatable and simple to change

**Customer Challenges faced in Autoclave and Environmental Chamber applications**

Many applications need their process values (i.e. Temperature, Pressure, Flow etc) to be varied with time.

Amongst other applications Autoclaves are used for Sterilisation and for Vacuum Forming. In these applications there are invariably a number of ramps, and dwell times required to ensure that the material has been adequately processed.

In Environmental Chambers programmed profiles are generally run repeatedly for some time and this is a method that is used to produce accelerated ageing. This process is therefore very useful for determining the likely longevity of a product before it fails.

**Solution 2400 Controller**

- The 2400 series process controller offer setpoint programming as an option. The program is stored as a series of segments which can be ramps, dwells, steps etc.
- All 2400 programmer/controllers have an 8 segment program as standard, and can optionally have up to 20 off 16 segment programs each with 8 digital events. The digital events are used to control other ancillary equipment at pre-determined segments in the program. For instance; it may switch on a vibration table at some stage in the process.
- All of these features make the 2400 programmer/controller ideal for Furnaces, Environmental Chambers, and Autoclave applications.

**Customer Benefits**

- Minimises the need for extra equipment which becomes costly to install and maintain, time and space saving
- Offers high integrity, repeatable processing thus increasing yield consistency and high product quality

**Typical use of technology**

- Autoclaves - Steam Sterilization of medical, pharmaceutical and laboratory equipment
- Environmental chambers -test the effects of environmental conditions such as accelerated aging on industrial products, materials, biological items and electronic devices
- Industrial furnaces - Heat Treatment, Glass Furnaces, and Lehrs

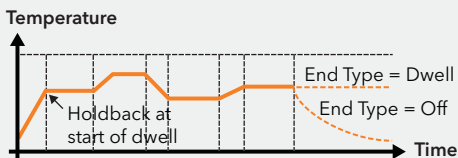

# Real-world applications

From fixed build to modular construction, the Eurotherm flexible 2000 Series offers a truly versatile solution to all your requirements.

## PDS setpoint retransmission



In 2000 Series controllers it is possible to use the PDS communication link to send a setpoint from one controller to a network of slave devices - providing the economical creation of multi-zone temperature control solutions.

## Reduced installation and commissioning time

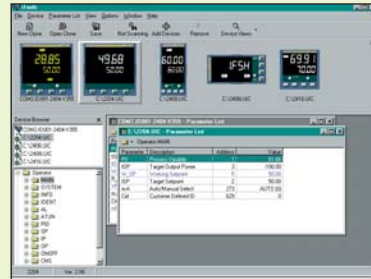

iTools configuration software enables you to store and clone controller configurations, as well as commission your process control system. This facility significantly reduces installation and commissioning time while improving the security of the process. The Eurotherm advanced customer sensor linearisation tool also provides for the download of special sensor response characteristics to the controller.

## Communication

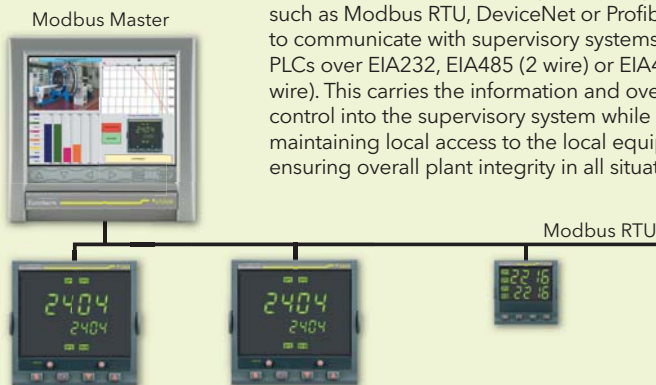

The 2000 Series uses industry standard protocols such as Modbus RTU, DeviceNet or Profibus DP to communicate with supervisory systems and PLCs over EIA232, EIA485 (2 wire) or EIA422 (4 wire). This carries the information and overall control into the supervisory system while maintaining local access to the local equipment ensuring overall plant integrity in all situations.

## Cascade control

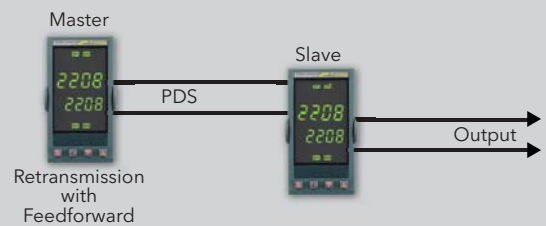

Using Eurotherm setpoint retransmission over PDS communications it is possible to use two 2400 controllers as a cascade control system with the output of the first (or master controller) forming the setpoint of the second (or slave controller).

Eurotherm advanced algorithms enable the use of either setpoint or PV feedforward to limit the slave setpoint - for example  $\pm 10\%$  of the master setpoint or PV.

## Derived inputs

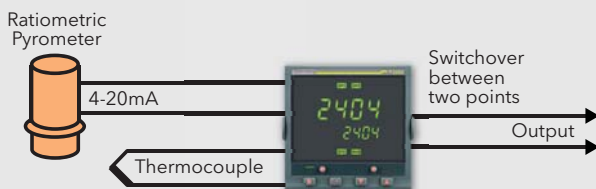

Sometimes it is desirable to control a process using two separate inputs to derive the PV (process value). This could be based on a highest wins, lowest wins, some function of the two inputs, or switching between the two inputs at some pre-determined point in the process.

For example, an application could consist of a thermocouple for measuring up to 800°C and a Ratiometric Pyrometer for measuring the range between 700°C and 1,400°C.

Typically when the temperature is below 740°C the thermocouple provides the PV and, when between 740°C and 780°C the controller switches gently from the thermocouple to the Pyrometer which provides the PV up to 1,400°C.

## Easy setpoint programming

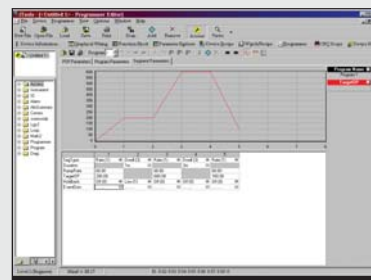

From a simple ramp and dwell to a 16 segment program with event outputs, the 2000 Series provides a powerful platform for setpoint profiling. Programs can be edited from the instrument HMI and for the 2400 instruments, using iTools Setpoint Program Editor.



## Selection guide

Single Loop	2400			2100		2200		
Features								
Panel size (DIN)	1/16	1/8	1/4	1/32	1/16	1/16 DIN rail	1/8	1/4
IP Rating	IP65			IP65		IP65		
Display Type	2 x 4 dig LED			1 x 4 dig LED		2 x 4 dig LED		
Supply Voltage	24V dc/ac 85-264V ac			24V dc/ac 85-264V ac		85-264V ac		
Input Type	TC, RTD, mV, mA, Volts			TC, RTD, mV, mA, V		TC, RTD, mV, mA, Volts		
PV Accuracy	<0.2%			<0.25%		<0.25%		
Control Types	On/Off, PID, VP			On/Off, PID		On/Off, PID, VP		
Special Features	Dual input control			none		none		
SP Programmer	20 x 16 segments			none		none		
Analogue IP/OP	In: 2 Out: 3			In: 1 Out: 0		In: 1 Out: 1		
Digital IP/OP	In: 11 Out: 11			In: 1 Out: 2		In: 3 Out: 4		
Digital Comms	Modbus, DeviceNet, Profibus			none		Modbus, DeviceNet		
Maths Equation	none			none		none		
Combinational Logic	none			none		none		
Timers/Counters/Totals	none			none		none		
Real Time Clock	none			none		none		
Alarm Types	Hi, Lo, Dev, Sensor break, Event, Heater fail			Hi, Lo, Dev, Sensor break,		Hi, Lo, Dev, Sensor break, Event, Heater fail		
PC Configuration	List based			List based		List based		

# Eurotherm: International sales and service



www.eurotherm.com

Eurotherm is also represented in the following countries:

Afghanistan	Latvia
Albania	Lesotho
Algeria	Libya
Angola	Lithuania
Argentina	Macedonia
Armenia	Madagascar
Azerbaijan	Malaysia
Bahrain	Malta
Bangladesh	Micronesia
Barbados	Moldova
Belarus	Morocco
Bermuda	Mozambique
Bolivia	Myanmar
Bosnia and Herzegovina	Namibia
Botswana	Nicaragua
Brazil	Niger
Brunei Darussalam	Nigeria
Bulgaria	Norway
Cambodia	Oman
Cameroon	Pakistan
Canada	Palestinian Territory
Central African Republic	Papua New Guinea
Chad	Paraguay
Chile	Peru
Colombia	Philippines
Congo	Poland
Costa Rica	Qatar
Côte d'Ivoire	Romania
Croatia	Russia
Cyprus	Rwanda
Czech Republic	Saudi Arabia
Denmark	Senegal
Djibouti	Serbia and Montenegro
Ecuador	Sierra Leone
El Salvador	Singapore
Eritrea	Slovakia
Estonia	Slovenia
Ethiopia	Somalia
Fiji	South Africa
Finland	Sri Lanka
Georgia	Sudan
Ghana	Swaziland
Greece	Syria
Greenland	Tajikistan
Guinea	Tanzania
Hungary	Thailand
Iceland	The Gambia
Indonesia	Tunisia
Iraq	Turkey
Israel	Turkmenistan
Jamaica	Uganda
Japan	Ukraine
Jordan	United Arab Emirates
Kazakhstan	Uruguay
Kenya	Uzbekistan
Kuwait	Venezuela
Kyrgyzstan	Vietnam
Laos	Yemen
	Zambia
	Zimbabwe

**AUSTRALIA** Melbourne  
Invensys Process Systems  
Australia Pty. Ltd.  
**T** (+61 0) 8562 9800  
**F** (+61 0) 8562 9801  
**E** info.eurotherm.au@invensys.com

**AUSTRIA** Vienna  
Eurotherm GmbH  
**T** (+43 1) 7987601  
**F** (+43 1) 7987605  
**E** info.eurotherm.at@invensys.com

**BELGIUM & LUXEMBOURG**  
Moha  
Eurotherm S.A/N.V.  
**T** (+32) 85 274080  
**F** (+32) 85 274081  
**E** info.eurotherm.be@invensys.com

**BRAZIL** Campinas-SP  
Eurotherm Ltda.  
**T** (+5519) 3707 5333  
**F** (+5519) 3707 5345  
**E** info.eurotherm.br@invensys.com

**CHINA**  
Eurotherm China  
**T** (+86 21) 61451188  
**F** (+86 21) 61452602  
**E** info.eurotherm.cn@invensys.com

Beijing Office  
**T** (+86 10) 5909 5700  
**F** (+86 10) 5909 5709/5909 5710  
**E** info.eurotherm.cn@invensys.com

**FRANCE** Lyon  
Eurotherm Automation SA  
**T** (+33 478) 664500  
**F** (+33 478) 352490  
**E** info.eurotherm.fr@invensys.com

**GERMANY** Limburg  
Eurotherm Deutschland GmbH  
**T** (+49 6431) 2980  
**F** (+49 6431) 298119  
**E** info.eurotherm.de@invensys.com

**INDIA** Mumbai  
Invensys India Pvt. Ltd.  
**T** (+91 22) 67579800  
**F** (+91 22) 67579999  
**E** info.eurotherm.in@invensys.com

**IRELAND** Dublin  
Eurotherm Ireland Limited  
**T** (+353 1) 4691800  
**F** (+353 1) 4691300  
**E** info.eurotherm.ie@invensys.com

**ITALY** Como  
Eurotherm S.r.l.  
**T** (+39 031) 975111  
**F** (+39 031) 977512  
**E** info.eurotherm.it@invensys.com

**KOREA** Seoul  
Invensys Operations Management  
Korea  
**T** (+82 2) 2090 0900  
**F** (+82 2) 2090 0800  
**E** info.eurotherm.kr@invensys.com

**NETHERLANDS** Alphen a/d Rijn  
Eurotherm B.V.  
**T** (+31 172) 411752  
**F** (+31 172) 417260  
**E** info.eurotherm.nl@invensys.com

**POLAND** Katowice  
Invensys Eurotherm Sp z o.o.  
**T** (+48 32) 7839500  
**F** (+48 32) 7843608/7843609  
**E** info.eurotherm.pl@invensys.com

**SPAIN** Madrid  
Eurotherm España SA  
**T** (+34 91) 6616001  
**F** (+34 91) 6619093  
**E** info.eurotherm.es@invensys.com

**SWEDEN** Malmo  
Eurotherm AB  
**T** (+46 40) 384500  
**F** (+46 40) 384545  
**E** info.eurotherm.se@invensys.com

**SWITZERLAND** Wollerau  
Eurotherm Produkte (Schweiz) AG  
**T** (+41 44) 7871040  
**F** (+41 44) 7871044  
**E** info.eurotherm.ch@invensys.com

**UNITED KINGDOM** Worthing  
Eurotherm Limited  
**T** (+44 1903) 268500  
**F** (+44 1903) 265982  
**E** info.eurotherm.uk@invensys.com

**U.S.A.** Ashburn VA  
Eurotherm Inc.  
**T** (+1 703) 724 7300  
**F** (+1 703) 724 7301  
**E** info.eurotherm.us@invensys.com

ED63

Represented by:

© Copyright Eurotherm Limited 2011

Invensys, Eurotherm, the Eurotherm logo, Chessell, EurothermSuite, Mini8, Eycou, Eyris, EPower, nanodac and Wonderware are trademarks of Invensys plc, its subsidiaries and affiliates. All other brands may be trademarks of their respective owners.

All rights are strictly reserved. No part of this document may be reproduced, modified, or transmitted in any form by any means, nor may it be stored in a retrieval system other than for the purpose to act as an aid in operating the equipment to which the document relates, without the prior written permission of Eurotherm limited.

Eurotherm Limited pursues a policy of continuous development and product improvement. The specifications in this document may therefore be changed without notice. The information in this document is given in good faith, but is intended for guidance only.

Eurotherm Limited will accept no responsibility for any losses arising from errors in this document.



invensys  
Operations Management