

Bridgelux Vero 18 Array Series

Product Data Sheet DS32

BXRC-17E4000, 25E4000, 27x4000, 30x4000, 35E4000, 40x4000, 50x4000, 56G4000



Introduction

Vero™ represents a revolutionary advancement in chip on board (COB) light source technology and innovation. These new LED light sources simplify luminaire design and manufacturing processes, improve light quality, and define a platform for future functionality integration.

Vero is available in four different LES (light emitting surface) configurations and has been engineered to reliably operate over a broad current range, enabling new degrees of flexibility in luminaire design optimization. These new arrays deliver increased lumen density to enable improved beam control and precision lighting with 2 and 3 SDCM color control standard for clean and consistent uniform lighting.

Vero includes an on board connector port to enable solder free electrical interconnect and simple easy to use mounting features to enable plug-and-play installation.

Features

- Market leading efficacy, 122 lm/W typical and 111 lm/W minimum
- Vero 18 lumen output performance ranges from 950 to as much as 8,200 lumens
- Broad range of CCT options from 2700K to 5600K
- CRI options include minimum 70, 80, and 90 2 and 3 SDCM color control for 2700K-4000K CCT
- Reliable operation at up to 2X nominal drive current
- Radial die pattern and improved lumen density
- Thermally isolated solder pads
- Onboard connector port
- Top side part number markings

Benefits

- Broad application coverage for interior and exterior lighting
- Flexibility for application driven lighting design requirements
- High quality true color reproduction
- Uniform consistent white light
- Flexibility in design optimization
- Improved optical control
- Enhanced ease of use and manufacturability
- Solder-less connectivity enables plug & play installation and field upgradability
- Improved inventory management and quality control



Table of Contents	Page
Product Feature Map	3
Product Nomenclature	3
Top Side Part Number Markings	4
Enhanced Connectivity Options	4
Lumen Maintenance Characteristics	4
Environmental Compliance	4
UL Recognition	4
CE Recognition	5
Minor Product Change Policy	5
Case Temperature Measurement Point	5
CAUTION: CONTACT WITH LIGHT EMITTING SURFACE (LES)	5
CAUTION: CHEMICAL EXPOSURE HAZARD	5
CAUTION: EYE SAFETY	5
CAUTION: RISK OF BURN	5
Production Selection Guide	6
Performance at Commonly Used Drive Currents	7
Flux & Electrical Characteristics	8
Absolute Maximum Ratings	9
Drive Current vs. Forward Voltage Characteristics	10
Typical Relative Luminous Flux vs. Drive Current, $T_j = 25^\circ\text{C}$	10
Typical Light Output Characteristics vs. Temperature	11
Typical Chromaticity Characteristics vs. Temperature	12
Typical Radiation Pattern	13
Wavelength Characteristics at Drive Current, $T_j = 25^\circ\text{C}$	14
Mechanical Dimensions	14
Color Binning Information	15 – 16
Design Resources	17
About Bridgelux	17

Product Feature Map

Vero 18 is the second largest form factor in the exciting new Vero family of next generation solid state light sources. In addition to delivering the performance and light quality required for many lighting applications, Vero incorporates several features to simplify the design integration and manufacturing process, accelerate time to market and reduce system costs. Please consult the Bridgelux Vero Array Series Product Brief for more information on the Vero family of products.

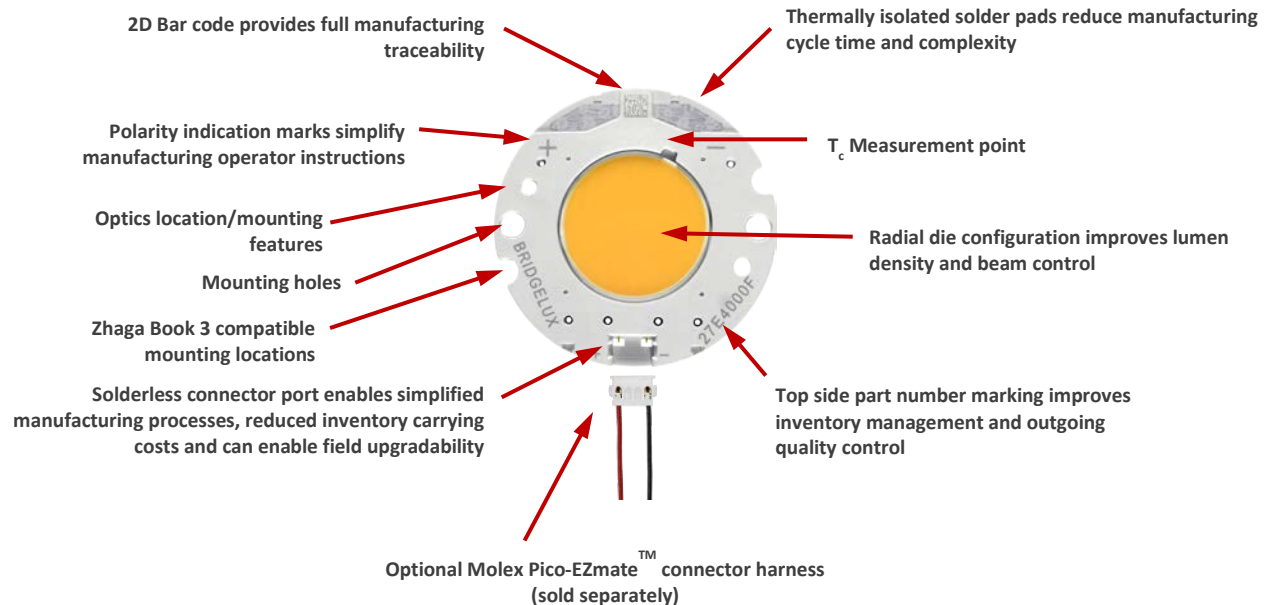

Product Nomenclature

The part number designation for Bridgelux Vero LED arrays is explained as follows:

BXRC – AB C DEFG – H – IJ

Where:

BXRC – Designates product family

AB – Designates the nominal color temperature; 27 = 2700K; 30 = 3000K, etc.

C – Designates minimum CRI; C = 70, E = 80, G = 90

DEFG – Designates nominal flux; 1000 = 1,000 lm, 2000 = 2,000 lm, 4000 = 4,000 lm, 10K0 = 10,000 lm, etc.

H – Designates array configuration

IJ – Designates CCT Bin options

02 = 2 SDCM

03 = 3 SDCM

04 = 4 SDCM

Top Side Part Number Markings

Vero includes a top side part number marking to help simplify inventory management and increase opportunities for production quality control. Any Vero product can be quickly identified to determine the product configuration, color or CRI by simply looking at its top side markings. Unlike previous product generations where markings were included only on the back side of the array, no longer is it necessary to handle (turnover), uninstall the array in an in-field application or guess which product it is by the color of the phosphor area. The Vero line of LED array products also has a 2D bar code which provides additional information and full product traceability for quality control purposes.

Enhanced Connectivity Options

Vero's thermally isolated solder pads have been designed to make soldering fast and secure. For those who prefer an even faster solderless installation, Vero has a connector port that can be used to further simplify your manufacturing process, reduce inventory cost and allow for field upgradability. The connector port mates to the Molex Pico-EZmate connector harness, sold separately by Molex and through their distribution network. The Molex connector harnesses come in a variety of wire lengths and wire gauge options and can also be custom engineered to meet your specific design requirements. Please consult your local Molex sales representative or visit www.molex.com for more information.

Lumen Maintenance Characteristics

Bridgelux projects that the Vero 18 family of LED array products will deliver, on average, greater than 70% lumen maintenance after 50,000 hours of operation at two times the nominal drive current in Table 1. This performance assumes constant current operation at up to 2 times the nominal drive current with case temperature maintained at or below 85°C. Continuous use beyond five years may result in a lower lumen maintenance. For use beyond these operating conditions please consult your Bridgelux sales representative for further assistance.

These projections are based on a combination of package test data, semiconductor chip reliability data, a fundamental understanding of package related degradation mechanisms, and performance observed from products installed in the field using Bridgelux die technology. Bridgelux conducts lumen maintenance tests per LM-80. Observation of design limits is required in order to achieve this projected lumen maintenance.

Environmental Compliance

Bridgelux is committed to providing environmentally friendly products to the solid-state lighting market. Vero LED Arrays comply with the European Union directives on the restriction of hazardous substances in electronic equipment, namely the RoHS directive. Bridgelux does not intentionally add the following restricted materials to any LED array products: lead, mercury, cadmium, hexavalent chromium, polybrominated biphenyls (PBB) or polybrominated diphenyl ethers (PBDE).

UL Recognition

Bridgelux secures UL Recognition for all of its LED array products. Please refer to the UL file 357031 for the latest list of UL Recognized Bridgelux LED arrays. Bridgelux uses UL Recognized materials with suitable flammability ratings in the Vero LED array products to streamline the process for customers to secure UL listing of the final luminaire product.

CE Recognition

In accordance with the relevant European Union Directives, the BXRC series LED array products conform to the applicable requirements of the IEC/EN 62031:2008 (LED Modules for General Lighting Safety Specifications) and IEC 62471:2006 (Photobiological Safety of Lamps and Lamp Systems). Bridgelux maintains a CE Declaration of Conformity statement on its website and displays the CE mark on product packing labels.

Minor Product Change Policy

The rigorous qualification testing on products offered by Bridgelux provides performance assurance. Slight cosmetic changes that do not affect form, fit, or function may occur as Bridgelux continues product optimization.

Case Temperature Measurement Point

A case temperature measurement point location is included on the top surface of the Vero LED arrays. The location of this measurement point is indicated in the mechanical dimensions section of this data sheet.

The purpose of this measurement point is to allow the user access to a measurement point which correlates to the true case temperature on the back surface of the LED array. Once the LED array is installed, it is challenging to measure the back surface of the array, or true case temperature.

Consistent and repeatable temperature measurements can be correlated to the data sheet performance specifications and to published LM-80 reliability data. The use of the case temperature measurements point is fully explained in AN30.

CAUTION: CONTACT WITH LIGHT EMITTING SURFACE (LES)

Avoid any contact with the LES. Do not touch the LES of the Vero LED array or apply stress to the LES (yellow phosphor resin area). Contact may cause damage to the LED array.

Optics and reflectors must not be mounted in contact with the LES (yellow phosphor resin area). Optical devices may be mounted on the top surface of the plastic housing of the Vero LED array. Use the mechanical features of the LED array housing, edges and/or mounting holes to locate and secure optical devices as needed.

CAUTION: CHEMICAL EXPOSURE HAZARD

Exposure to some chemicals commonly used in luminaire manufacturing and assembly can cause damage to the LED array. Please consult Bridgelux Application Note AN31 for additional information.

CAUTION: EYE SAFETY

Eye safety classification for the use of Bridgelux Vero LED arrays is in accordance with IEC specification EN62471: Photobiological Safety of Lamps and Lamp Systems. Vero LED arrays are classified as Risk Group 1 (Low Risk) when operated at or below the maximum drive current. Please use appropriate precautions. It is important that employees working with LEDs are trained to use them safely.

CAUTION: RISK OF BURN

Do not touch the Vero LED array or yellow resin area during operation. Allow the array to cool for a sufficient period of time before handling. The Vero LED array may reach elevated temperatures such that could burn skin when touched.

Product Selection Guide

The following product configurations are available:

Table 1: Selection Guide, Pulsed Measurement Data (T_j = T_c = 25°C)

Part Number ^[1]	Nominal CCT (K)	CRI	Nominal Drive Current ^[5] (mA)	Typical Pulsed Flux ^[4] T _j = 25°C (lm)	Typical V _f (V)	Typical Power (W)	Typical Efficacy (lm/W)
BXRC-17E4000-F-xx ^[7]	1750	80	1050	2100	29.5	31.0	68
BXRC-25E4000-F-xx ^[7]	2500	80	1050	2700	29.5	31.0	87
BXRC-27E4000-F-xx	2700	80	1050	3650	29.5	31.0	118
BXRC-27G4000-F-xx	2700	90	1050	2920	29.5	31.0	94
BXRC-27H4000-F-xx ^[6]	2700	97	1050	2340	29.5	31.0	76
BXRC-30E4000-F-xx	3000	80	1050	3780	29.5	31.0	122
BXRC-30G4000-F-xx	3000	90	1050	3100	29.5	31.0	100
BXRC-30H4000-F-xx ^[6]	3000	97	1050	2550	29.5	31.0	82
BXRC-35E4000-F-xx	3500	80	1050	3920	29.5	31.0	127
BXRC-40E4000-F-xx	4000	80	1050	3990	29.5	31.0	129
BXRC-40G4000-F-03	4000	90	1050	3515	29.5	31.0	113
BXRC-50C4000-F-04	5000	70	1050	4400	29.5	31.0	142
BXRC-50E4000-F-04	5000	80	1050	4045	29.5	31.0	130
BXRC-50G4000-F-04	5000	90	1050	3670	29.5	31.0	118
BXRC-56G4000-F-04	5600	90	1050	3515	29.5	31.0	113

Notes for Table 1:

1. The “-xx” suffix refers to color control, “-02” for 2SDCM, “-03” for 3SDCM or “-04” for 4SDCM.
2. Typical stabilized DC performance values are provided as reference only and are not a guarantee of performance.
3. Typical performance is estimated based on operation under DC (direct current) with the LED array mounted onto a heat sink with thermal interface material and the case temperature maintained at 85°C. Based on Bridgelux test setup, values may vary depending on the thermal design of the luminaire and/or the exposed environment to which the product is subjected.
4. Bridgelux maintains a ± 7% tolerance on flux measurements.
5. Drive current is referred to as nominal drive current.
6. Please refer to DS34 for complete information regarding the Bridgelux Décor products.
7. Performance specifications for the BXRC-17E4000-F-xx and BXRC-25E4000-F-xx are preliminary and subject to change.

Product Selection Guide Continued

Table 2: Selection Guide, Stabilized DC Performance (T_c = 85°C)^{[2][3]}

Part Number ^[1]	Nominal CCT (K)	CRI	Nominal Drive Current ^[5] (mA)	Typical DC Flux T _c = 85°C (lm)	Typical V _f (V)	Typical Power (W)	Typical Efficacy (lm/W)
BXRC-17E4000-F-xx ^[7]	1750	80	1050	1820	27.9	29.3	62
BXRC-25E4000-F-xx ^[7]	2500	80	1050	2340	27.9	29.3	80
BXRC-27E4000-F-xx	2700	80	1050	3150	27.9	29.3	108
BXRC-27G4000-F-xx	2700	90	1050	2530	27.9	29.3	86
BXRC-30E4000-F-xx	3000	80	1050	3270	27.9	29.3	112
BXRC-30G4000-F-xx	3000	90	1050	2680	27.9	29.3	91
BXRC-35E4000-F-xx	3500	80	1050	3390	27.9	29.3	116
BXRC-40E4000-F-xx	4000	80	1050	3450	27.9	29.3	118
BXRC-40G4000-F-03	4000	90	1050	3040	27.9	29.3	109
BXRC-50C4000-F-04	5000	70	1050	3810	27.9	29.3	130
BXRC-50E4000-F-04	5000	80	1050	3500	27.9	29.3	125
BXRC-50G4000-F-04	5000	90	1050	3170	27.9	29.3	114
BXRC-56G4000-F-04	5600	90	1050	3040	27.9	29.3	109

Notes for Table 2:

1. The "-xx" suffix refers to color control, "-02" for 2SDCM, "-03" for 3SDCM or "-04" for 4SDCM.
2. Typical stabilized DC performance values are provided as reference only and are not a guarantee of performance.
3. Typical performance is estimated based on operation under DC (direct current) with the LED array mounted onto a heat sink with thermal interface material and the case temperature maintained at 85°C. Based on Bridgelux test setup, values may vary depending on the thermal design of the luminaire and/or the exposed environment to which the product is subjected.
4. Bridgelux maintains a ± 7% tolerance on flux measurements.
5. Drive current is referred to as nominal drive current.
6. Please refer to DS34 for complete information regarding the Bridgelux Décor products.
7. Performance specifications for the BXRC-17E4000-F-xx and BXRC-25E4000-F-xx are preliminary and subject to change.

Performance at Commonly Used Drive Currents

Vero LED arrays are tested to the specifications shown in Table 4. Vero may also be driven at other drive currents dependent on specific application design requirements. The performance at any drive current can be derived from the current vs. voltage characteristics shown in Figure 1 and the flux vs. current characteristics shown in Figure 2. The performance at commonly used drive currents is summarized in Table 3.

Table 3: Product Performance at Commonly Used Drive Currents

Part Number	CRI	Drive Current (mA) ^[1]	Typical V _f T _j = 25°C (V)	Typical Watt T _j = 25°C (W)	Typical Flux T _j = 25°C (lm) ^[2]	Typical DC Flux T _c = 85°C (lm) ^{[2][3]}	Typical Efficacy T _j = 25°C (lm/W)
BXRC-17E4000-F-xx ^[4]	80	1050	29.5	31.0	2100	1820	68
		1400	30.4	42.6	2720	2320	64
		2100	31.6	66.3	3900	3220	59
BXRC-25E4000-F-xx ^[4]	80	1050	29.5	31.0	2700	2340	87
		1400	30.4	42.6	3490	2980	82
		2100	31.6	66.3	5010	4140	76
BXRC-27E4000-F-xx	80	1050	29.5	31.0	3650	3150	118
		1400	30.4	42.6	4710	4020	111
		2100	31.6	66.3	6770	5590	102
BXRC-27G4000-F-xx	90	1050	29.5	31.0	2920	2530	94
		1400	30.4	42.6	3780	3220	89
		2100	31.6	66.3	5430	4480	82
BXRC-30E4000-F-xx	80	1050	29.5	31.0	3780	3270	122
		1400	30.4	42.6	4890	4170	115
		2100	31.6	66.3	7020	5800	106
BXRC-30G4000-F-xx	90	1050	29.5	31.0	3100	2680	100
		1400	30.4	42.6	4000	3410	94
		2100	31.6	66.3	5750	4750	87
BXRC-35E4000-F-xx	80	1050	29.5	31.0	3920	3390	127
		1400	30.4	42.6	5070	4320	119
		2100	31.6	66.3	7280	6010	110
BXRC-40E4000-F-xx	80	1050	29.5	31.0	3990	3450	129
		1400	30.4	42.6	5160	4400	121
		2100	31.6	66.3	7410	6120	112
BXRC-40G4000-F-03	90	1050	29.5	31.0	3515	3040	113
		1400	30.4	42.6	4550	3880	107
		2100	31.6	66.3	6530	5390	98
BXRC-50C4000-F-04	70	1050	29.5	31.0	4400	3810	142
		1400	30.4	42.6	5690	4850	134
		2100	31.6	66.3	8170	6750	123
BXRC-50E4000-F-04	80	1050	29.5	31.0	4045	3500	130
		1400	30.4	42.6	5230	4460	123
		2100	31.6	66.3	7510	6210	113
BXRC-50G4000-F-04	90	1050	29.5	31.0	3670	3170	118
		1400	30.4	42.6	4740	4040	111
		2100	31.6	66.3	6810	5630	103
BXRC-56G4000-F-04	90	1050	29.5	31.0	3515	3040	113
		1400	30.4	42.6	4550	3880	107
		2100	31.6	66.3	6530	5390	98

Notes for Table 3:

1. Values in bold correspond to performance at nominal drive current listed in Table 1. Alternate drive currents in Table 3 are provided for reference only and are not a guarantee of performance.
2. Bridgelux maintains a ± 7% tolerance on flux measurements.
3. Typical stabilized DC performance values are provided as reference only and are not a guarantee of performance.
4. Performance specifications for the BXRC-17E4000-F-xx and BXRC-25E4000-F-xx are preliminary and subject to change.

Flux & Electrical Characteristics

Table 4: Flux Characteristics

CCT (K)	Part Number	CRI (min) [3][9]	Nominal Drive Current (mA) [1]	Typical Pulsed Flux $T_j = 25^\circ\text{C}$ (lm) [1][2]	Minimum Pulsed Flux $T_j = 25^\circ\text{C}$ (lm) [1],[2],[8]	Typical Center Beam Candle Power $T_j = 25^\circ\text{C}$ (cd) [4]	Typical DC Flux $T_c = 85^\circ\text{C}$ (lm) [5][6]	Minimum DC Flux $T_c = 85^\circ\text{C}$ (lm) [5][7]
1750	BXRC-17E4000-F-xx ^[10]	80	1050	2100	1910	670	1820	1650
2500	BXRC-25E4000-F-xx ^[10]	80	1050	2700	2460	860	2340	2120
2700	BXRC-27E4000-F-xx	80	1050	3650	3310	1160	3150	2870
	BXRC-27G4000-F-xx	90	1050	2920	2660	930	2530	2300
3000	BXRC-30E4000-F-xx	80	1050	3780	3440	1200	3270	2970
	BXRC-30G4000-F-xx	90	1050	3100	2810	990	2680	2430
3500	BXRC-35E4000-F-xx	80	1050	3920	3560	1250	3390	3080
4000	BXRC-40E4000-F-xx	80	1050	3990	3630	1160	3450	3140
	BXRC-40G4000-F-03	90	1050	3515	3200	1120	3040	2760
5000	BXRC-50C4000-F-04	70	1050	4400	4000	1160	3810	3460
	BXRC-50E4000-F-04	80	1050	4045	3680	1290	3500	3180
	BXRC-50G4000-F-04	90	1050	3670	3340	1170	3170	2880
5600	BXRC-56G4000-F-04	90	1050	3515	3200	1120	3040	2760

Notes for Table 4:

- Parts are tested in pulsed conditions, $T_j = 25^\circ\text{C}$. Pulse width is 10 ms at nominal drive current.
- Bridgelux maintains a $\pm 7\%$ tolerance on flux measurements.
- Typical R9 value for 90 CRI product options is 70.
- Center beam candle power is a calculated value based on Lambertian radiation pattern at nominal drive current.
- Typical stabilized DC performance values are provided as reference only and are not a guarantee of performance.
- Typical performance is estimated based on operation under DC (direct current) with the LED array mounted onto a heat sink with thermal interface material and the case temperature maintained at 85°C . Based on Bridgelux test setup, values may vary depending on the thermal design of the luminaire and/or the exposed environment to which the product is subjected.
- Minimum DC Flux values are provided for reference only and are not a parameter guaranteed by production testing. Based on Bridgelux test setup, values may vary depending on the thermal design of the luminaire and/or the exposed environment to which the product is subjected.
- Refer to Table 3 for typical performance at other drive currents.
- Décor 97 CRI products available. Please refer to DS34.
- Performance specifications for the BXRC-17E4000-F-xx and BXRC-25E4000-F-xx are preliminary and subject to change.

Flux & Electrical Characteristics Continued

Table 5: Electrical Characteristics and Driver Selection Voltages

Nominal Drive Current (mA) ^[1]	Forward Voltage Pulsed, T _j = 25°C (V) ^{[1][2]}			Typical Coefficient of Forward Voltage $\Delta V_f / \Delta T_j$ (mV/°C)	Typical Thermal Resistance Junction to Case $R\theta_{j-c}$ (C/W)	Driver Selection Voltages (V) ^[3]	
	Minimum	Typical	Maximum			V _f Min. Hot ^[4] T _c = 105°C (V)	V _f Max. Cold ^[4] T _c = - 40°C (V)
350	24.4	27.1	29.8	-21.0	0.53	22.6	31.0
700	25.6	28.4	31.2	-21.0	0.54	23.7	32.4
1050	26.6	29.5	32.5	-21.0	0.55	24.5	33.5
1400	27.4	30.4	33.5	-21.0	0.56	25.2	34.3
2100	28.4	31.6	34.7	-21.0	0.58	26.0	35.3

Notes for Table 5:

1. Parts are tested in pulsed conditions at the nominal drive current (indicated in bold font), T_j = 25°C. Pulse width is 10 ms.
2. Bridgelux maintains a tester tolerance of ± 0.10 V on forward voltage measurements.
3. Forward voltage minimum and maximum values at the nominal drive current (indicated in bold font) are guaranteed by 100% test. Values provided at other drive currents are provided for reference only and are not guaranteed by test.
4. Vf Min hot and Vf max cold values are provided as reference only and are not guaranteed by test. These values are provided to aid in driver design and selection over the operating range of the product.

Absolute Maximum Ratings

Table 6: Maximum Drive Current and Reverse Voltage Ratings

Part Number	Drive Current for LM-80 (mA) ^[3]	Maximum Peak Pulsed Drive Current (mA) ^[1]	Maximum Reverse Voltage (V _r) ^[2]
BXRC-xxx4000-F-xx	2100	3000	-50

Notes for Table 6:

1. Bridgelux recommends a maximum duty cycle of 10% when operating LED Arrays at the maximum peak pulsed current specified. Maximum peak pulsed currents indicate values where the LED array can be driven without catastrophic failures.
2. Light emitting diodes are not designed to be driven in reverse voltage and will not produce light under this condition. Maximum rating provided for reference only.
3. Lumen maintenance (L70) and lifetime predictions are valid for drive current and case temperature conditions used for LM-80 testing as included in the applicable LM-80 test report for these products.

Table 7: Maximum Ratings

Parameter	Maximum Rating
LED Junction Temperature	150°C
Storage Temperature	-40°C to +105°C
Operating Case Temperature	105°C ^[2]
Soldering Temperature ^[1]	350°C for a maximum of 10 seconds

Notes for Table 7:

1. See Bridgelux Application Note AN31, Assembly Considerations for Vero LED arrays, for more information.
2. For IEC 62717 requirement, please contact Bridgelux Sales Support.

Drive Current versus Forward Voltage Characteristics

Figure 1: Typical Drive Current vs. Voltage

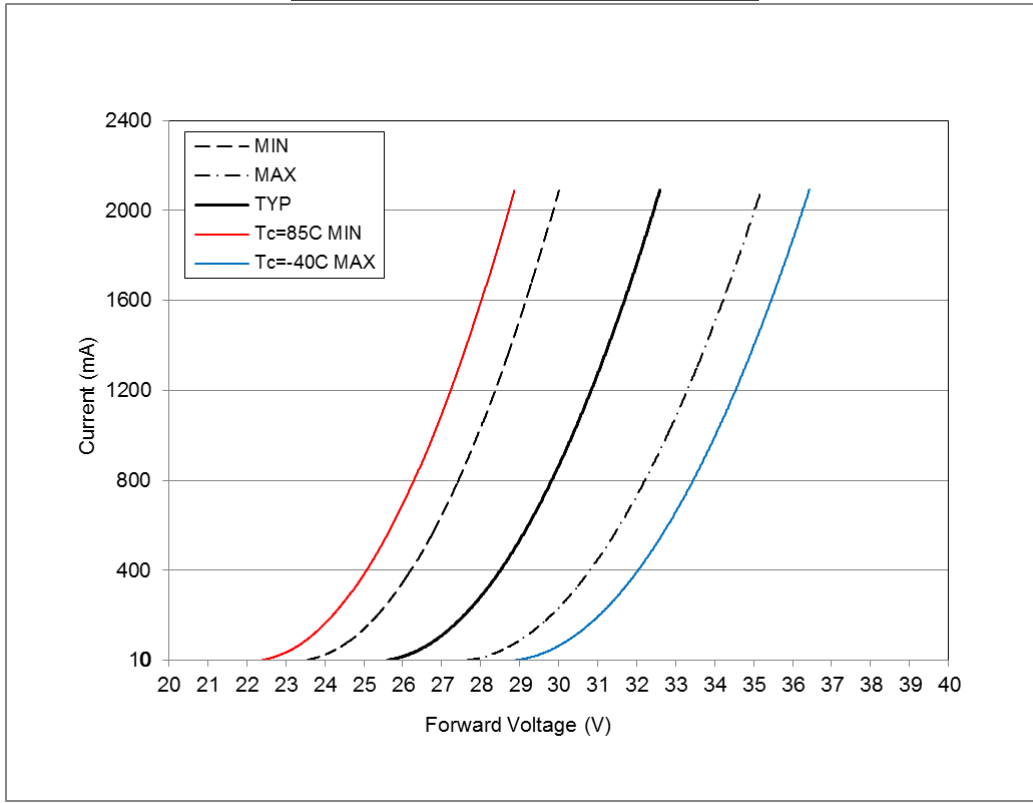

Typical Relative Luminous Flux vs. Drive Current, Tj=25°C

Figure 2: Typical Flux vs. Drive Current, Tj = 25°C

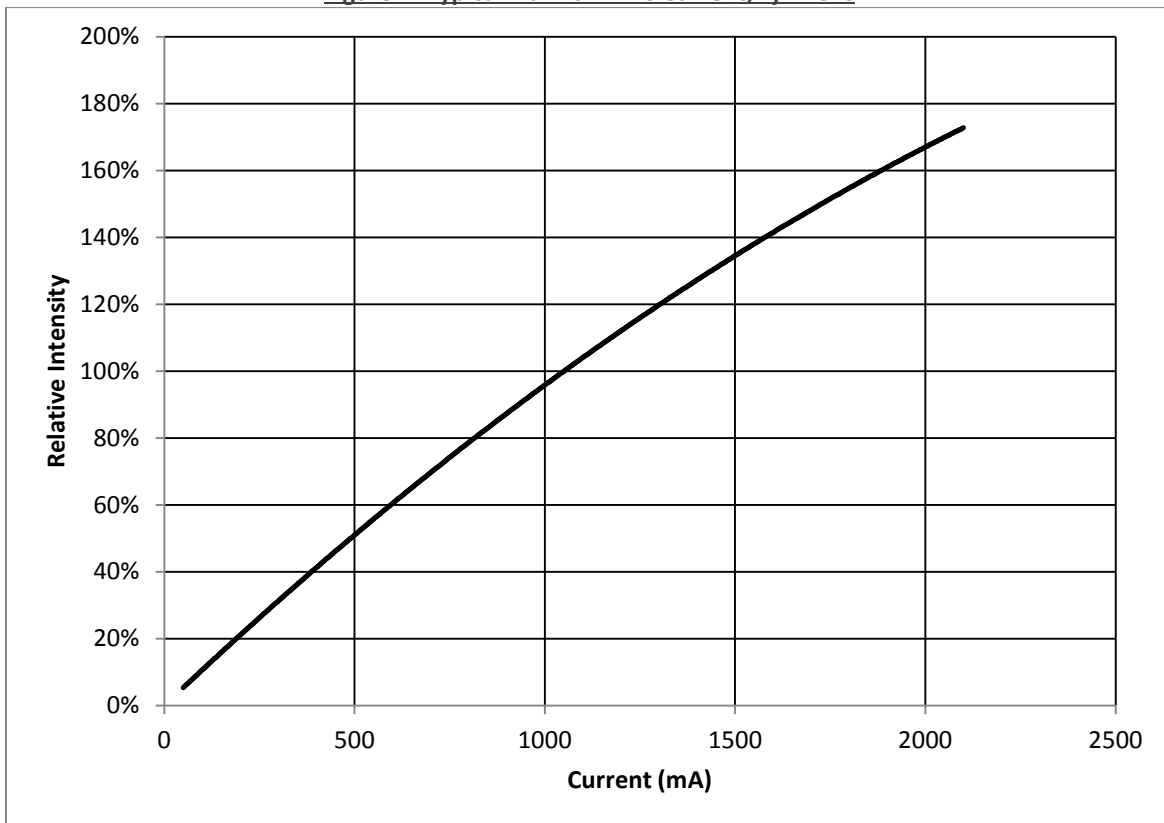

Typical Light Output Characteristics vs. Temperature

Figure 3: Typical Flux vs. Junction Temperature

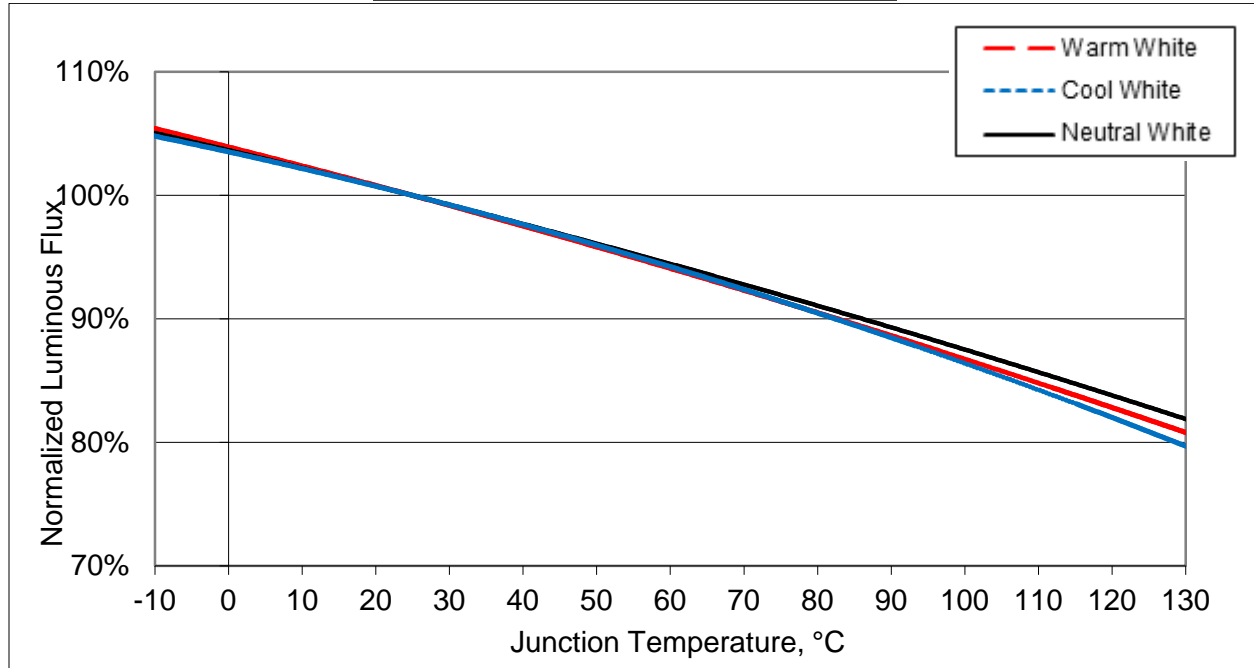

Notes for Figure 3:

1. Characteristics shown for warm white reflect 3000K 80 CRI.
2. Characteristics shown for neutral white reflect 4000K 80 CRI.
3. Characteristics shown for cool white reflect 5000K 70 CRI.

Typical Chromaticity Characteristics vs. Temperature

Figure 4: Typical ccy Shift vs. Junction Temperature

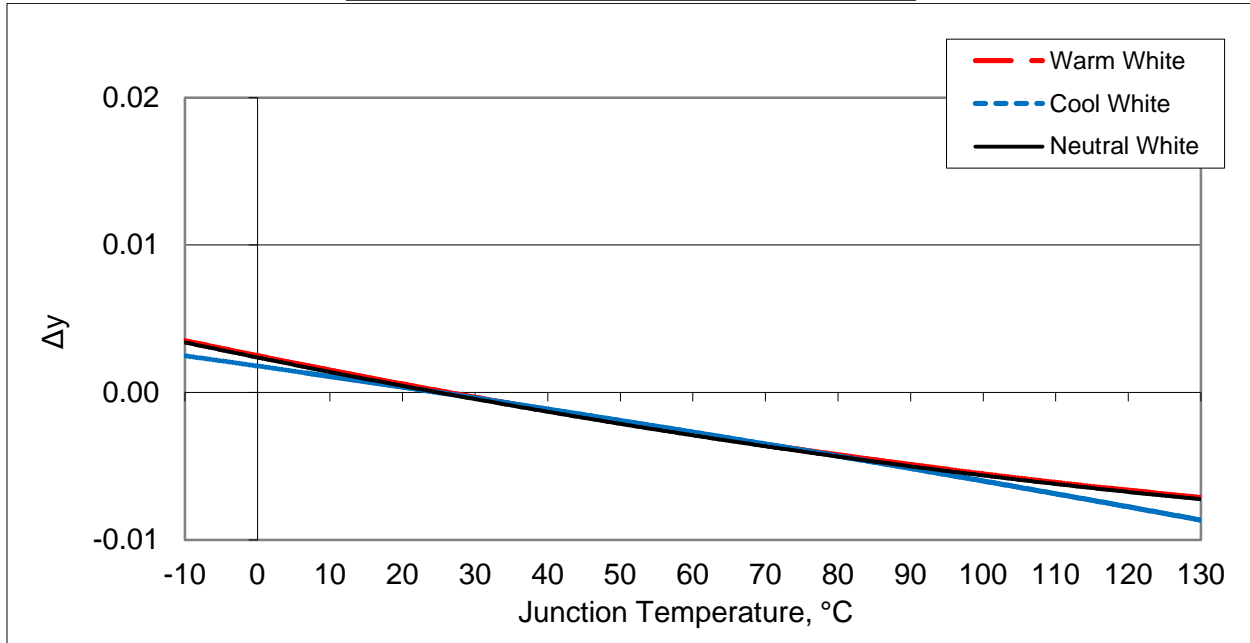
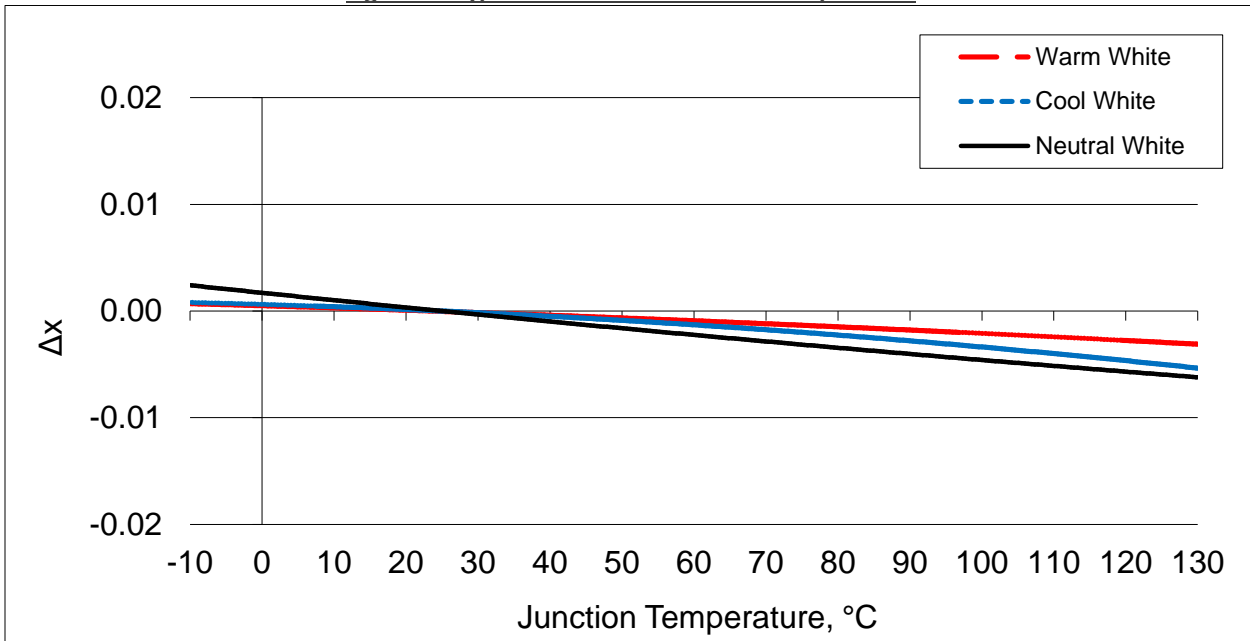

Figure 5: Typical ccx Shift vs. Junction Temperature



Notes for Figures 4 and 5:

1. Characteristics shown for warm white reflect 3000K 80 CRI.
2. Characteristics shown for neutral white reflect 4000K 80 CRI.
3. Characteristics shown for cool white reflect 5000K 70 CRI.

Typical Radiation Pattern

Figure 6: Typical Spatial Radiation Pattern

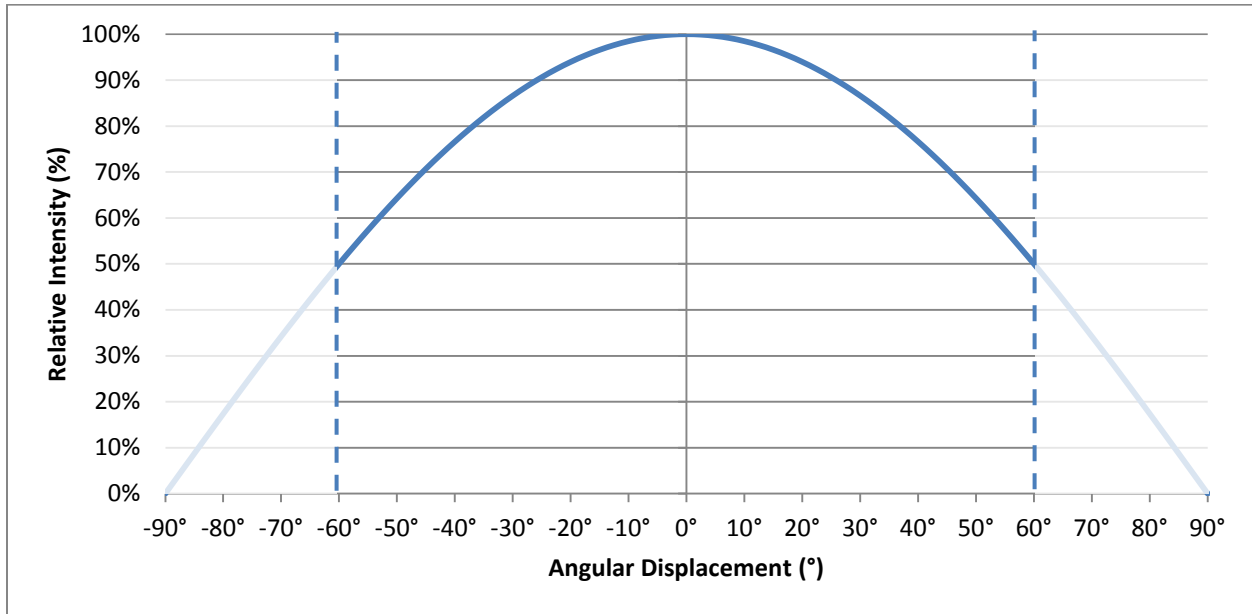

Notes for figure 6:

1. Typical viewing angle is 120°.
2. The viewing angle is defined as the off axis angle from the centerline where I_v is $\frac{1}{2}$ of the peak value.

Figure 7: Typical Polar Radiation Pattern

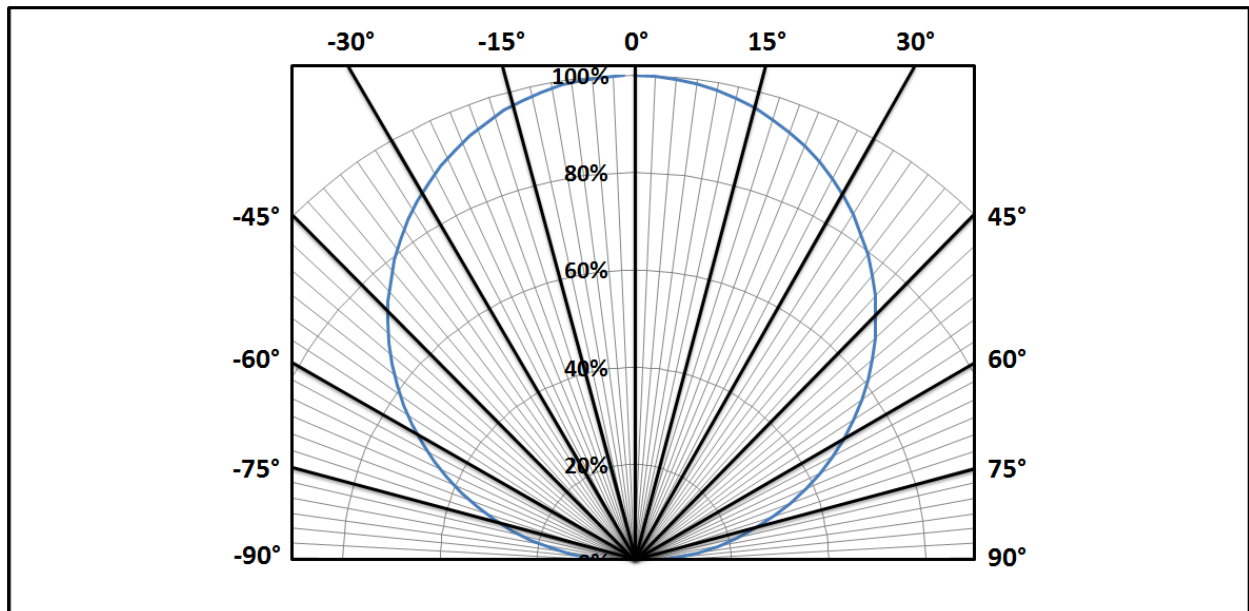

Wavelength Characteristics at Drive Current, T_j=25°C

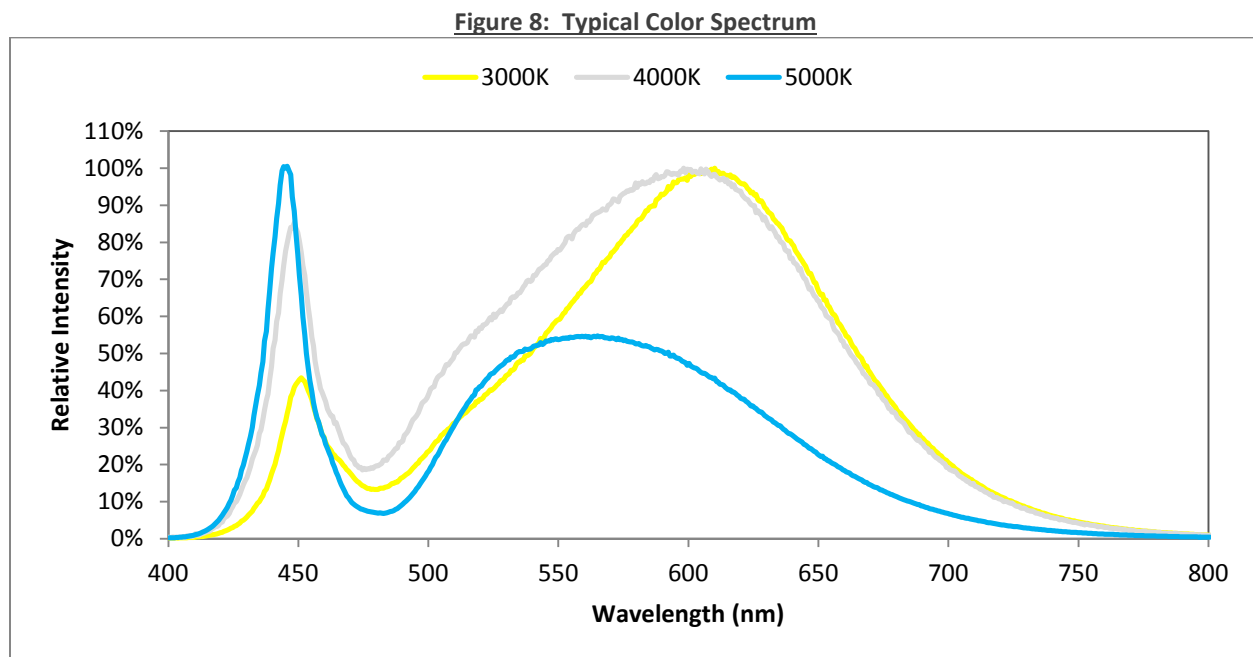

Notes for Figure 8:

1. Color spectrum shown for warm white is 3000K 80 CRI.
2. Color spectrum shown for neutral white is 4000K 80 CRI.
3. Color spectrum shown for cool white is 5000K 70 CRI.

Mechanical Dimensions

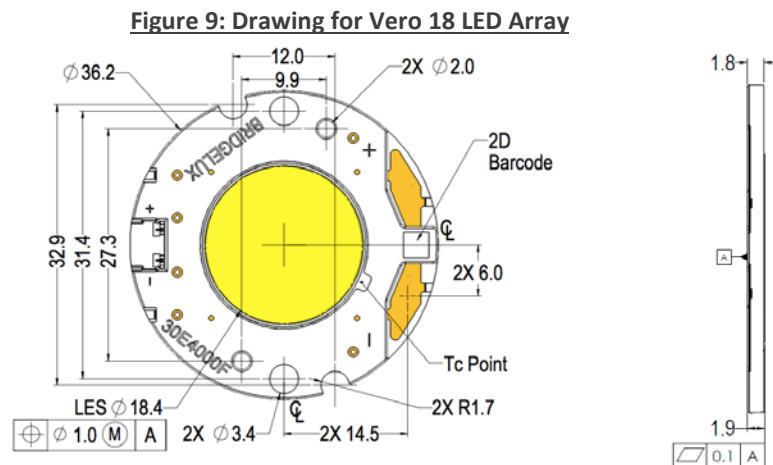

Notes for Figure 9:

1. Mounting holes (2X) are for M2.5 screws.
2. Bridgelux recommends two tapped holes for mounting screws with 31.4 ± 0.10 mm center-to-center spacing.
3. Screws with flat shoulders (pan, dome, button, round, truss, mushroom) provide optimal torque control. Do NOT use flat, countersink, or raised head screws.
4. Solder pads and connector port are labeled "+" and "-" to denote positive and negative, respectively.
5. It is not necessary to provide electrical connections to both the solder pads and the connector port. Either set may be used depending on application specific design requirements.
6. Drawings are not to scale.
7. Drawing dimensions are in millimeters.
8. Unless otherwise specified, tolerances are ± 0.10 mm.
9. Refer to Application Notes AN30 and AN31 for product handling, mounting and heat sink recommendations.
10. The optical center of the LED Array is nominally defined by the mechanical center of the array to a tolerance of ± 0.2 mm.
11. Bridgelux maintains a flatness of 0.10mm across the mounting surface of the array.
12. Bridgelux Vero 18 LED arrays are packaged in trays of 20 units with a maximum planar dimension of 215.0mm x 279.4 mm (8.5 x 11 inches) per tray.

Color Binning Information

Figure 10: Graph of Warm White Test Bins in xy Color Space

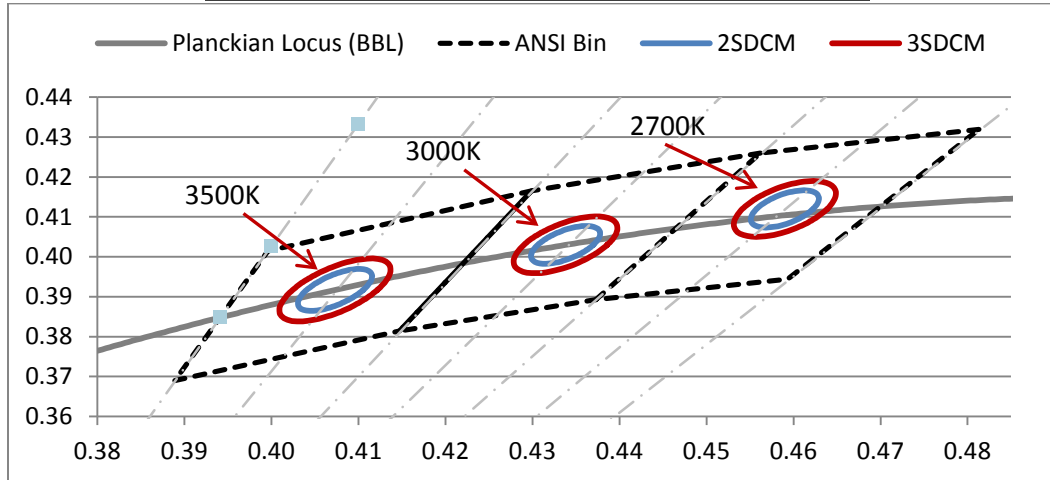

Note: Pulsed Test Conditions, $T_j = 25^\circ\text{C}$

Table 10: Warm White xy Bin Coordinates and Associated Typical CCT

Bin Code	2700K	3000K	3500K
ANSI Bin (for reference only)	(2580K - 2870K)	(2870K - 3220K)	(3220K - 3710K)
03 (3SDCM)	(2651K - 2794K)	(2968K - 3136K)	(3369K - 3586K)
02 (2SDCM)	(2674K - 2769K)	(2995K - 3107K)	(3404K - 3548K)
Center Point (x,y)	(0.4578, 0.4101)	(0.4338, 0.403)	(0.4073, 0.3917)

Figure 11: Graph of Neutral White Test Bins in xy Color Space

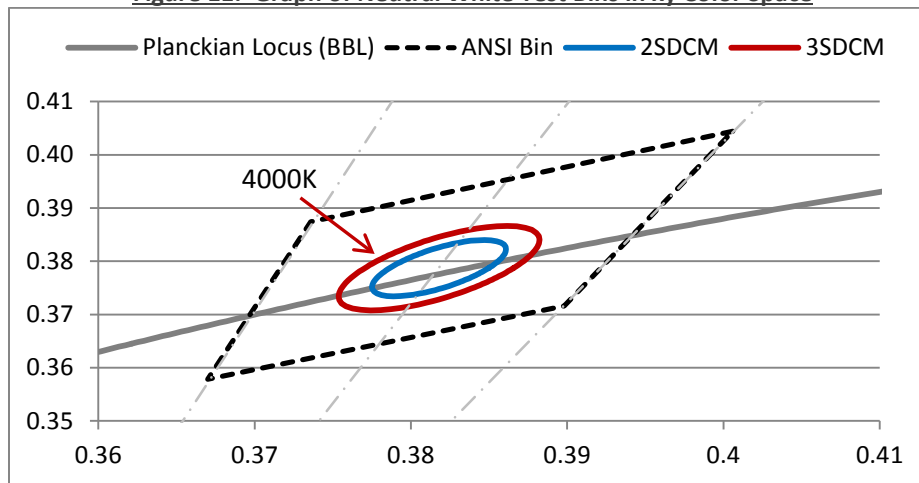

Note: Pulsed Test Conditions, $T_j = 25^\circ\text{C}$

Table 11: Neutral White xy Bin Coordinates and Associated Typical CCT

Bin Code	4000K
ANSI Bin (for reference only)	(3710K - 4260K)
03 (3SDCM)	(3851K - 4130K)
02 (2SDCM)	(3895K - 4081K)
Center Point (x,y)	(0.3818, 0.3797)

Color Binning Information (continued)

Figure 12: Graph of Cool White Test Bins in xy Color Space

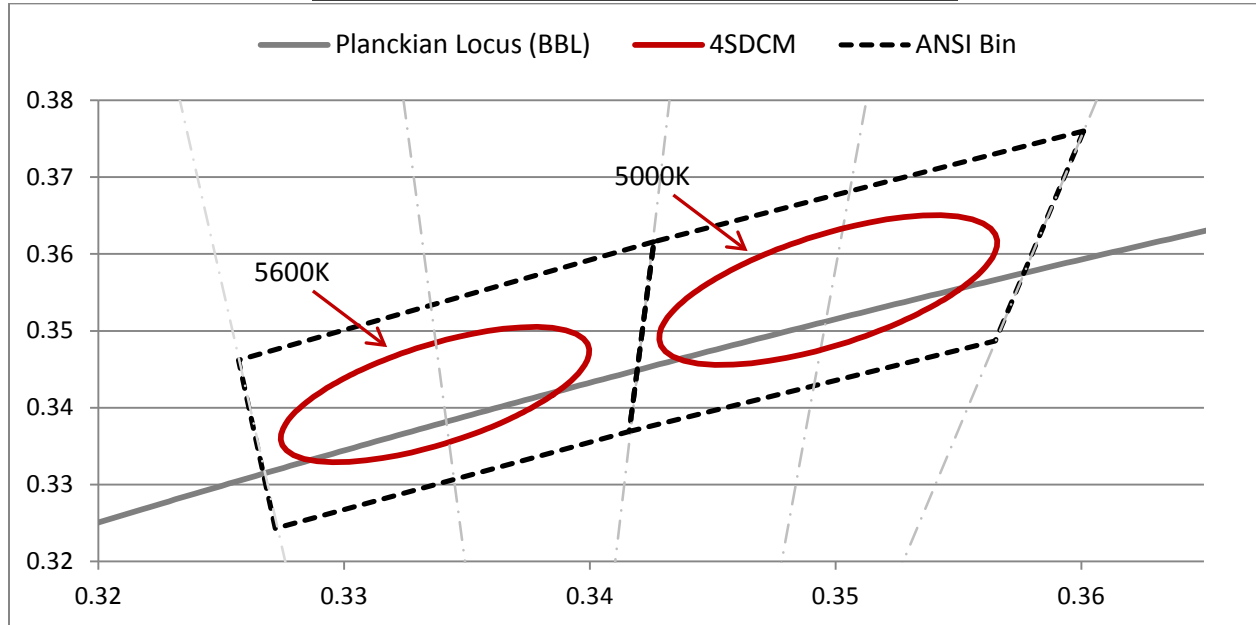

Note: Pulsed Test Conditions, $T_j = 25^\circ\text{C}$

Table 12: Cool White xy Bin Coordinates and Associated Typical CCT

Bin Code	5000K	5600K
ANSI Bin (for reference only)	(4745K - 5310K)	(5310K - 6020K)
04 (4SDCM)	(4801K - 5282K)	(5396K - 5970K)
Center Point (x,y)	(0.3447, 0.3553)	(0.3287, 0.3417)

Design Resources

Bridgelux is developing a comprehensive set of application notes and design resources to assist customers in successfully designing with the Vero product family of LED array products. Included below is a list of resources under development which will be downloaded from the Bridgelux web site under the Design Resources section.

Application Notes

- AN30: Effective Thermal Management of Bridgelux Vero LED Arrays
- AN31: Assembly Considerations for Bridgelux Vero LED Arrays
- AN32: Electrical Drive Considerations for Bridgelux Vero LED Arrays
- AN34: Reliability Data Sheet for Bridgelux Vero LED Arrays
- AN36: Optical Considerations for Bridgelux Vero LED Arrays

Optical Source Models

Optical source models and ray set files are available for all Bridgelux Vero LED array products. The list below contains the formats currently available. If you require a specific format not included in this list, please contact your Bridgelux sales representative for assistance.

- Zemax
- ASAP
- IESNA
- LightTools
- LucidShape
- OPTIS SPEOS
- PHOTOPIA
- TracePro
- Radiant Imaging Source Model

3D CAD Models

Three dimensional CAD models depicting the product outline of all Bridgelux Vero LED arrays are available in both SAT and STEP formats. Please contact your Bridgelux sales representative for assistance.

About Bridgelux

Bridgelux is a leading developer and manufacturer of technologies and solutions transforming the \$40 billion global lighting industry into a \$100 billion market opportunity. Based in Livermore, California, Bridgelux is a pioneer in solid state lighting (SSL), expanding the market for light emitting diode (LED) technologies by driving down the cost of LED lighting systems. Bridgelux's patented light source technology replaces traditional technologies (such as incandescent, halogen, fluorescent and high intensity discharge lighting) with integrated, solid state lighting solutions that enable lamp and luminaire manufacturers to provide high performance and energy efficient white light for the rapidly growing interior and exterior lighting markets, including street lights, commercial lighting and consumer applications.

For more information about the company, please visit www.bridgelux.com.

Bridgelux and the Bridgelux stylized logo design are registered trademarks, and Vero is a trademark, of Bridgelux, Inc. All other trademarks are the property of their respective owners.