

**PLEASE CHECK WWW.MOLEX.COM FOR LATEST PART INFORMATION**

**Part Number:** [19002-0016](#)  
**Status:** **Active**  
**Description:** Avikrimp™ Fully Insulated Quick Disconnect, Female, for 18-22 AWG Wire, Box

**Documents:**

[Drawing \(PDF\)](#) [Product Specification PS-19902-014 \(PDF\)](#)  
[Product Specification PS-19902-011 \(PDF\)](#) [RoHS Certificate of Compliance \(PDF\)](#)  
[Product Specification PS-19902-013 \(PDF\)](#)

**Agency Certification**

CSA LR18689  
 UL E79133

**General**

Product Family Quick Disconnects  
 Series [19002](#)  
 Crimp Quality Equipment Yes  
 Insulated Fully  
 Product Name Avikrimp™  
 Type Quick Disconnect  
 UPC 800753027152

**Physical**

Barrel Type Closed  
 Color - Resin Red  
 Flammability 94V-2  
 Gender Female  
 Glow-Wire Compliant No  
 Insulation Nylon (PA)  
 Lock to Mating Part None  
 Material - Metal Brass  
 Material - Plating Mating Tin  
 Material - Plating Termination Tin  
 Net Weight 0.662g  
 Orientation Straight  
 Packaging Type Bag  
 Plating min - Mating 4.064µm  
 Plating min - Termination 4.064µm  
 Polarized to Mating Part No  
 Tab Thickness 0.81mm  
 Tab Width 2.79mm  
 Temperature Range - Operating -65°C to +105°C  
 Termination Interface: Style Crimp or Compression  
 Wire Insulation Diameter 3.17mm max.  
 Wire Size AWG 18, 20, 22  
 Wire Size mm² 0.35 - 0.80

**Electrical**

Voltage - Maximum 300V

**Material Info**

Old Part Number AA-5279

**Reference - Drawing Numbers**

Product Specification PS-19902-011, PS-19902-013, PS-19902-014  
 Sales Drawing SD-19002-003

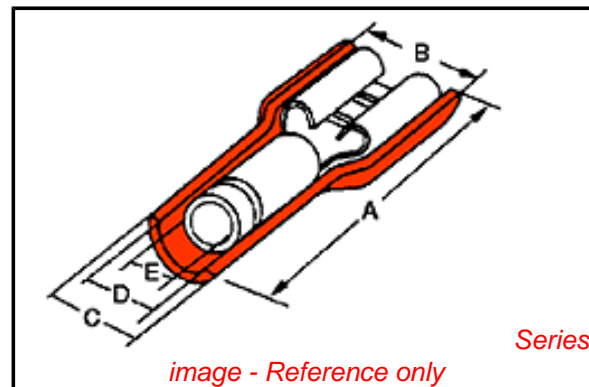

**EU RoHS**

**ELV and RoHS Compliant**  
**REACH SVHC Contains SVHC: No**  
**Low-Halogen Status Low-Halogen**

**China RoHS**



**Need more information on product environmental compliance?**

Email [productcompliance@molex.com](mailto:productcompliance@molex.com)  
 For a multiple part number RoHS Certificate of Compliance, [click here](#)

Please visit the [Contact Us](#) section for any non-product compliance questions.

**Search Parts in this Series**

[19002Series](#)

**Application Tooling | FAQ**

*Tooling specifications and manuals are found by selecting the products below. Crimp Height Specifications are then contained in the Application Tooling Specification document.*

**Global**

Description	Product #
Hand Crimp Tool	<a href="#">0640010800</a>
Crimp Head for the AT-200™ Pneumatic Hand Tool	<a href="#">0640050800</a>

This document was generated on 06/30/2014

**PLEASE CHECK [WWW.MOLEX.COM](http://WWW.MOLEX.COM) FOR LATEST PART INFORMATION**