

Ultra-Broadband Pick-off Tee

PSPL5370 Datasheet

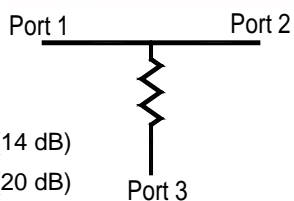

The PSPL5370 Pickoff Tee is an ultra-broadband resistive coupler, which provides a scaled (5x or 10x) replica of signals passing through the tee. The device exhibits excellent through-line insertion loss and pickoff ratio stability for frequencies from DC to >25 GHz. The PSPL5370 features good impedance match across a wide range of frequencies, with return loss typically >15 dB from 0-25 GHz.



200Ω (14 dB)
450Ω (20 dB)

- Low insertion loss
- DC to >25 GHz
- 5x and 10x pickoffs
- ≤14 ps risetime

Specifications

Parameter	PSPL5370 option 14DB	PSPL5370 option 20DB
Pickoff Insertion Loss (S31)	14.8 dB, nominal DC 15 ± 1 dB, 0-25 GHz, guaranteed	20.4 dB, nominal DC 20.5 ± 2.0 dB, 0-25 GHz, guaranteed
Through-line Insertion Loss (S21)	0.8 dB, nominal DC 0.8 (+0.2,-1.0) dB, 0-25 GHz, guaranteed	0.4 dB, nominal DC 0.4 (+0.2,-1.2) dB, 0-25 GHz, guaranteed
Risetime (10% - 90%)	12 ps	14 ps
Return Loss (S11)	>20 dB, DC <15 dB, 0-10 GHz, guaranteed ≥12.5 dB, 10-25 GHz, guaranteed	>24 dB, DC <20 dB, 0-10 GHz, guaranteed ≥13 dB, 10-25 GHz, guaranteed
Pickoff Resistor	200±2% Ω, guaranteed	450±2% Ω, guaranteed
Through-line Group Delay Tolerance (S21)	± 7.5 ps guaranteed up to 25 GHz (750 MHz aperture)	
In/Out Impedance @ DC (port 1 or port 2)	41.7 Ω, nominal	45.5 Ω, nominal
Temperature Range	-55 to +90 °C Operating	
Max Input Power, (Port 1 or 2, Avg)	2 W	4 W
Warranty	One Year	

Notes: All parameters listed are typical unless max/min guaranteed limits are provided. The DC specs are valid only when used with 50Ω source and terminations.

Typical Performance

Insertion Loss, Through Path

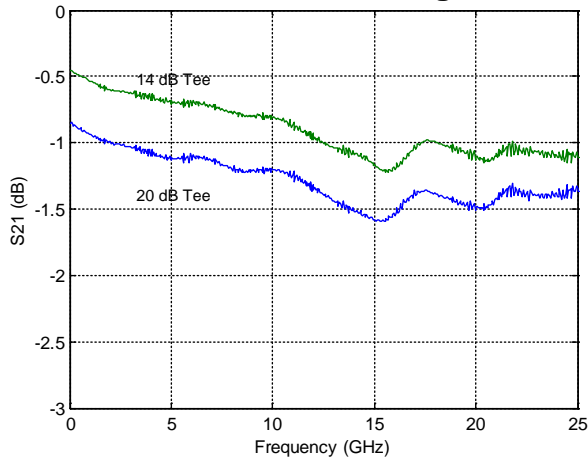

Insertion Loss, Pick-off Path

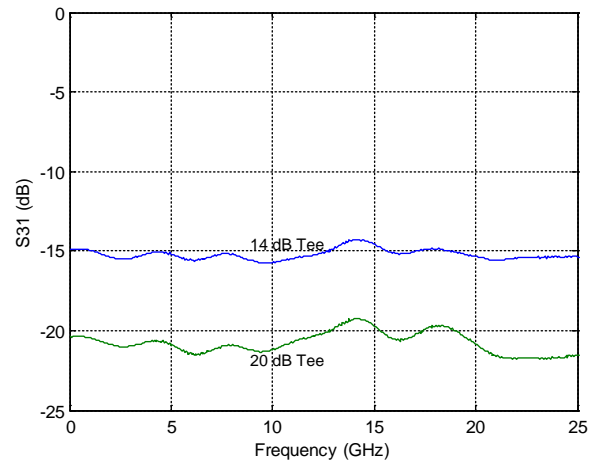

Return Loss, Ports 1 and 2

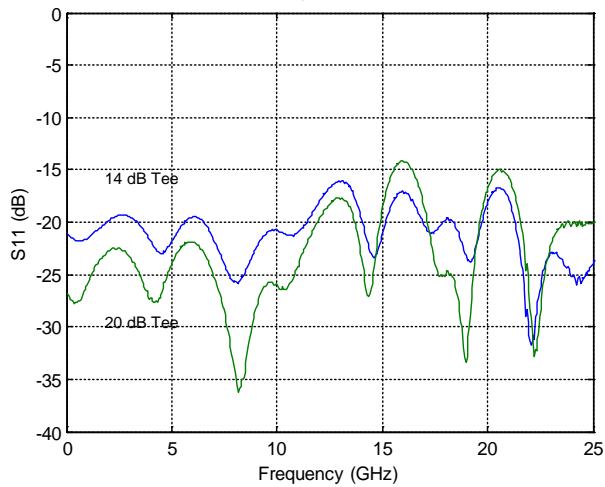

S11 Input TDR Response to 25 ps Risetime Pulse, Scale 5% p/div, Timebase, 50 ps/div

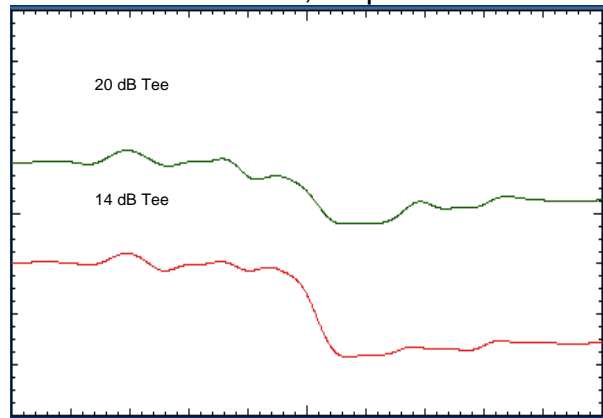

Transmission Responses to 15 ps risetime steps into Port 1.

Timebase 20 ps/div, Pickoff Transmission (S31) scaled 5x (10x for 20 dB Tee).

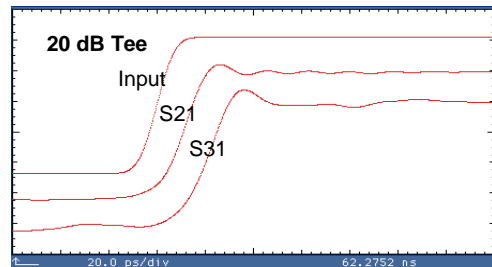
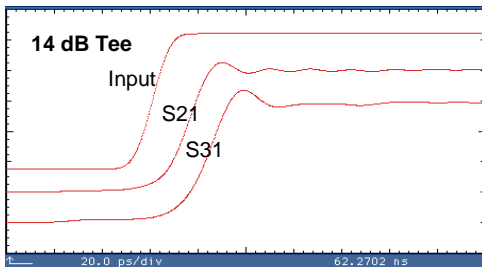

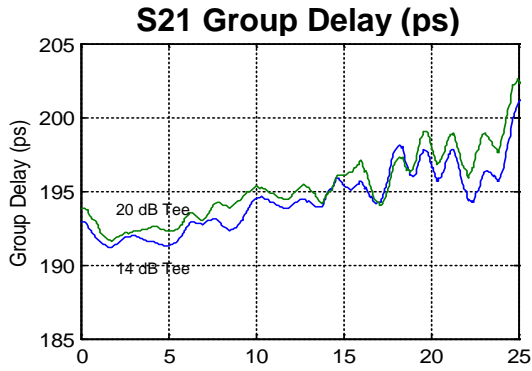

PSPL5370 Mechanical dimensions

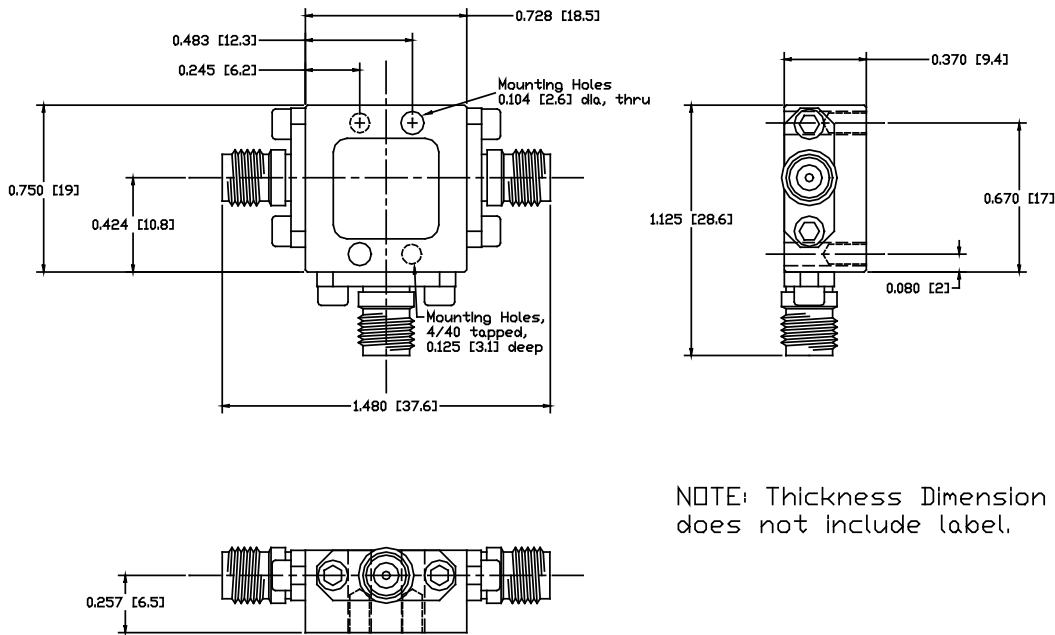

NOTE: Thickness Dimension does not include label.

Ordering information

Model	Description
PSPL5370	Pick-Off Tee, 14dB, 5x

Options

- Opt. 14DB 14dB Pick-Off
- Opt. 20DB 20dB Pick-Off

PSPL5370 Ultra-broadband Pick-Off Tee

ASEAN / Australasia (65) 6356 3900

Belgium 00800 2255 4835*

Central East Europe and the Baltics +41 52 675 3777

Finland +41 52 675 3777

Hong Kong 400 820 5835

Japan 81 (3) 6714 3010

Middle East, Asia, and North Africa +41 52 675 3777

People's Republic of China 400 820 5835

Republic of Korea 001 800 8255 2835

Spain 00800 2255 4835*

Taiwan 886 (2) 2722 9622

* European toll-free number. If not accessible, call: +41 52 675 3777

Austria 00800 2255 4835*

Brazil +55 (11) 3759 7627

Central Europe & Greece +41 52 675 3777

France 00800 2255 4835*

India 000 800 650 1835

Luxembourg +41 52 675 3777

The Netherlands 00800 2255 4835*

Poland +41 52 675 3777

Russia & CIS +7 (495) 6647564

Sweden 00800 2255 4835*

United Kingdom & Ireland 00800 2255 4835*

Balkans, Israel, South Africa and other ISE Countries +41 52 675 3777

Canada 1 800 833 9200

Denmark +45 80 88 1401

Germany 00800 2255 4835*

Italy 00800 2255 4835*

Mexico, Central/South America & Caribbean 52 (55) 56 04 50 90

Norway 800 16098

Portugal 80 08 12370

South Africa +41 52 675 3777

Switzerland 00800 2255 4835*

USA 1 800 833 9200

Updated 10 April 2013

For Further Information. Tektronix maintains a comprehensive, constantly expanding collection of application notes, technical briefs and other resources to help engineers working on the cutting edge of technology.

Please visit www.tektronix.com.

Copyright © Tektronix, Inc. All rights reserved. Tektronix products are covered by U.S. and foreign patents, issued and pending. Information in this publication supersedes that in all previously published material. Specification and price change privileges reserved. TEKTRONIX and TEK are registered trademarks of Tektronix, Inc. All other trade names referenced are the service marks, trademarks, or registered trademarks of their respective companies.

29 May 2014



1PW-30593-0

www.tektronix.com

Tektronix[®]