

PSPL5500 Series DC Blocks

PSPL5500A, PSPL5501A, PSPL5508 Datasheet



The PSPL5500 Series of DC Blocks is composed of extremely broadband, coaxial blocking capacitors. Due to the coaxial construction, excellent microwave and very fast rise time responses are achieved. The PSPL5508 has a -3 dB bandwidth in excess of 26 GHz and a rise time faster than 8 ps. Large capacitance values up to 2.2 μF are available that give -3 dB low frequency cutoffs as low as 0.7 kHz.

Key performance specifications

- 0.7 kHz to > 26 GHz
- 8 ps Risetime

Typical performance

Insertion Loss
 0.25 dB/div,
 40 MHz to 25GHz,
 2.5 GHz/div

Group Delay
 5 ps/div,
 40 MHz to 25GHz,
 2.5 GHz/div

Return Loss
 5 dB/div,
 40 MHz to 25GHz,
 2.5 GHz/div

10 ps Step Response
 Top: In
 Bottom: Out
 20 ps/div

PSPL5500A

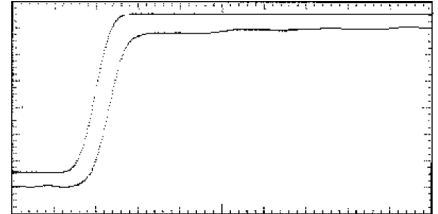
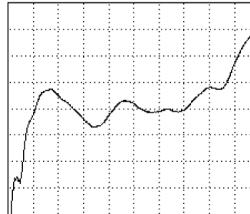
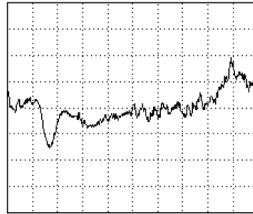
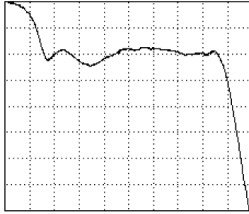

PSPL5501A

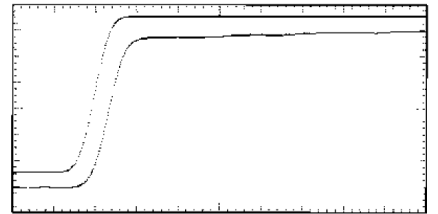
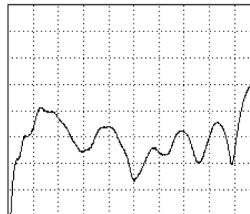
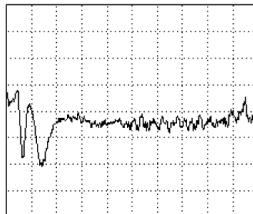
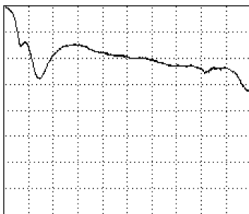

PSPL5508

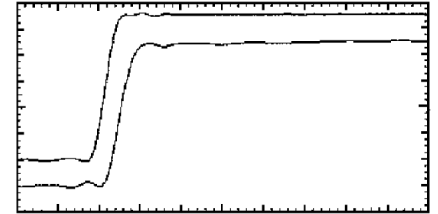
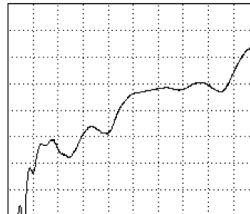
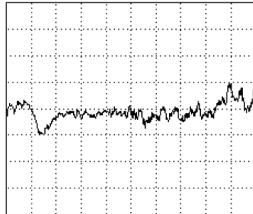
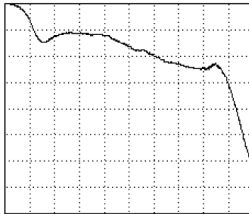

Specifications

All specifications apply to all models unless noted otherwise.

Parameter ¹	PSPL5500A	PSPL5501A	PSPL5508
Capacitance	0.02 μ F	0.22 μ F	2.2 μ F
Tolerance	20 %	-50, +80%	-50, +80%
DC Voltage	50 V max.	50 V max.	16 V max.
Type	inner	inner	inner
BW (-3 dB) guaranteed	> 26 GHz 20 GHz min.	> 26 GHz 20 GHz min.	> 26 GHz 20 GHz min.
Low Freq -3 dB	80 kHz	7 kHz	0.7 kHz
Risetime	10 ps	10 ps	< 8 ps
Insertion Loss	See S ₂₁ plots < 0.5 dB max. 100 MHz to 2 GHz is guaranteed		
Delay	155 ps, see S ₂₁ group delay plots for typical responses		
Impedance	50 Ω		
Return Loss	See S ₁₁ plots for typical responses		
Temp. Range	-55 C to +125 C, operating and storage		
Dimensions	37.1 mm x 12.7 mm x 12.7mm sq. (1.46" x 0.5" x 0.5") including connectors		
Connectors	SMA jack (f) & plug (m)		
Warranty	One Year		

Mechanical dimensions

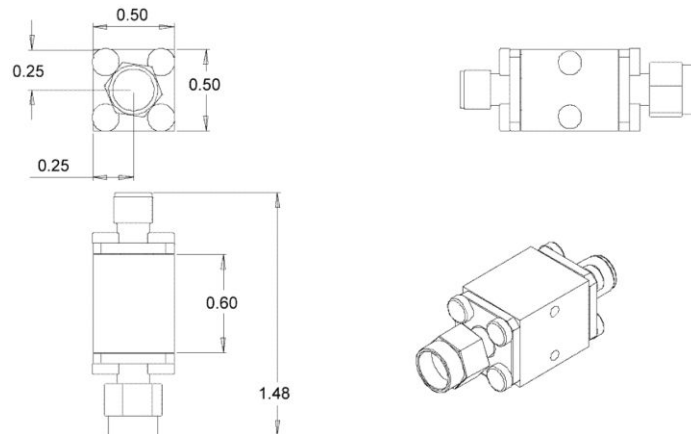

¹ Parameters listed are typical values. Max/min limits for capacitance, bandwidth and insertion loss are guaranteed.

Ordering information

Models

PSPL5500A	50 V DC block, 80 kHz
PSPL5501A	50 V DC block, 7 kHz
PSPL5508	16 V DC block

ASEAN / Australasia (65) 6356 3900
Belgium 00800 2255 4835*
Central East Europe and the Baltics +41 52 675 3777
Finland +41 52 675 3777
Hong Kong 400 820 5835
Japan 81 (3) 6714 3010
Middle East, Asia, and North Africa +41 52 675 3777
People's Republic of China 400 820 5835
Republic of Korea 001 800 8255 2835
Spain 00800 2255 4835*
Taiwan 886 (2) 2722 9622

Austria 00800 2255 4835*
Brazil +55 (11) 3759 7627
Central Europe & Greece +41 52 675 3777
France 00800 2255 4835*
India 000 800 650 1835
Luxembourg +41 52 675 3777
The Netherlands 00800 2255 4835*
Poland +41 52 675 3777
Russia & CIS +7 (495) 6647564
Sweden 00800 2255 4835*
United Kingdom & Ireland 00800 2255 4835*

Balkans, Israel, South Africa and other ISE Countries +41 52 675 3777
Canada 1 800 833 9200
Denmark +45 80 88 1401
Germany 00800 2255 4835*
Italy 00800 2255 4835*
Mexico, Central/South America & Caribbean 52 (55) 56 04 50 90
Norway 800 16098
Portugal 80 08 12370
South Africa +41 52 675 3777
Switzerland 00800 2255 4835*
USA 1 800 833 9200

* European toll-free number. If not accessible, call: +41 52 675 3777

Updated 10 April 2013

For Further Information. Tektronix maintains a comprehensive, constantly expanding collection of application notes, technical briefs and other resources to help engineers working on the cutting edge of technology. Please visit www.tektronix.com.

Copyright © Tektronix, Inc. All rights reserved. Tektronix products are covered by U.S. and foreign patents, issued and pending. Information in this publication supersedes that in all previously published material. Specification and price change privileges reserved. TEKTRONIX and TEK are registered trademarks of Tektronix, Inc. All other trade names referenced are the service marks, trademarks, or registered trademarks of their respective companies.



22 Jul 2014

1PW-30585-0

www.tektronix.com

