

General-purpose Relays and Power Relays Sockets

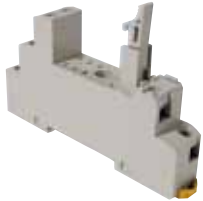

Relay Type	Track Mount Sockets	Back Connecting Sockets	
		Solder terminals	PCB terminals
G2R-1-S	P2RF-05 P2RF-05-E P2RF-05-S	P2R-05A	P2R-05P
G2R-2-S	P2RF-08 P2RF-08-E P2RF-08-S	P2R-08A	P2R-08P
LY1, LY2	PTF08A-E	PT08	PT08-0
LY3	PTF11A	PT11	PT11-0
LY4	PTF14A-E	PT14	PT14-0
MK2	PFO83A-E	PL08	PLR08-0
MK3	PF113A-E	PL11	PLE11-0
MY2	PYF08A-E PYF08A-N PYF08-S	PY08	PY08-02
MY3	PYF11A	PY11	PY11-02
MY4	PYF14A-E PYF14A-N PYF14S	PY14	PY14-02
MY2K	PYF14A-E	PY14	PY14-02
MY4(Z)H	PYF14A-E	-	-



Relay Type	Mounting Bracket	Track Mount Adaptor	Track Mount Socket
G7J-(ALL)	R99-04-FOR-G5F W bracket	-	-
G7L-1A-T	R99-07G5D E bracket	P7LF-D	P7LF-06
G7L-1A-TJ			P7LF-06
G7L-1A-B			-
G7L-1A-BJ			-
G7L-2A-T			P7LF-06
G7L-2A-TJ			P7LF-06
G7L-2A-B			-
G7L-2A-BJ			-







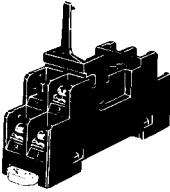
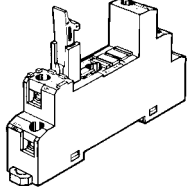
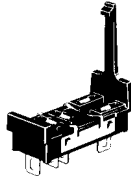
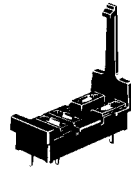
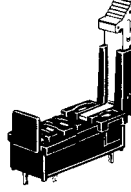
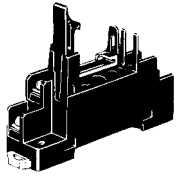
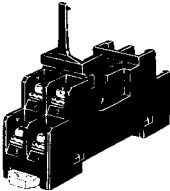
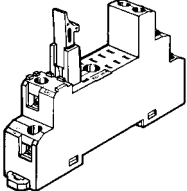
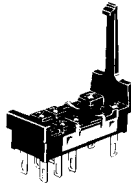
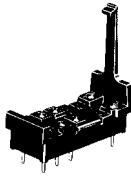
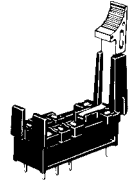

Mounting Track	Length
PFP-100N	1 meter
PFP-50N	.5 meter

Square Sockets

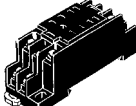
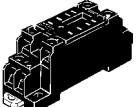
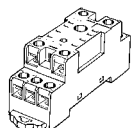
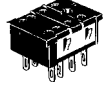
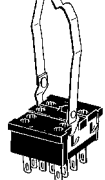
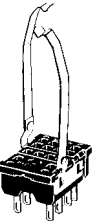
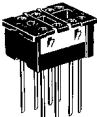
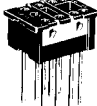
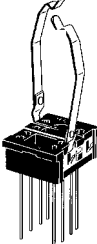

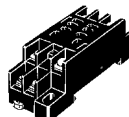

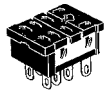

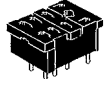



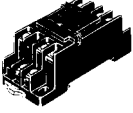

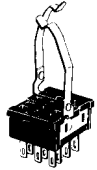
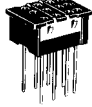
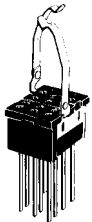
Item	P2RF (Track-mounting) *see page 246		P2R *see page 248			P7TF (Track-mounting) *see page 249
	Screw terminal		Solder terminal	PCB terminal		Screw terminal
5 pins	P2RF-05 Approx. 27 g 	P2RF-05-E Approx. 38 g 	P2R-05A Approx. 5 g 	P2R-05P Approx. 5 g 	P2R-057P Approx. 5.5 g 	P7TF-05 Approx. 28 g 
8 pins	P2RF-08 Approx. 33 g 	P2RF-08-E Approx. 38 g 	P2R-08A Approx. 5 g 	P2R-08P Approx. 5 g 	P2R-087P Approx. 5.5 g 	---

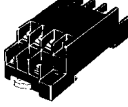
Note: □-E Models are of finger-protect construction. Round terminals cannot be used. Use Y-shaped terminals.

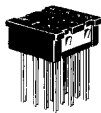
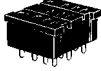
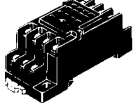
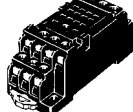
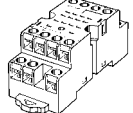
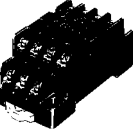
Square Sockets

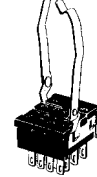
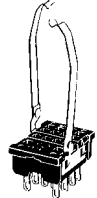
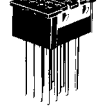
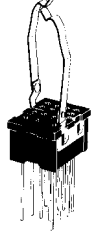

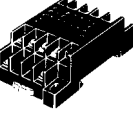
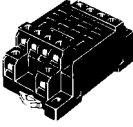
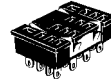
Item	PYF (Track-mounting) *see page 250	PY (back-connecting) *see page 252			PTF (Track-mounting) *see page 253	PT (back-connecting) *see page 255		
	Screw terminal	Solder terminal	Wrapping terminal	PCB terminal	Screw terminal	Solder terminal	Wrapping terminal	PCB terminal
8 pins	PYF08A Approx. 32 g  PYF08A-E  PYF08A-N 	PY08 Approx. 8 g  PY08-Y1  PY08-Y3 	PYQ08QN Approx. 12 g  PYQ08QN2  PYQ08QN-Y1 PYQ08QN2-Y1 	PY08-02 Approx. 7.2 g 	PTF08A Approx. 39 g  PTF08A-E 	PT08 Approx. 11 g 	PT08QN Approx. 10.4 g 	PT08-0 Approx. 8 g 

Note: □-E and □-N Models are of finger-protect construction. Round terminals cannot be used. Use Y-shaped terminals.



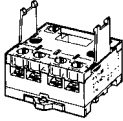

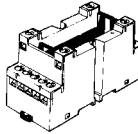





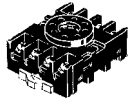

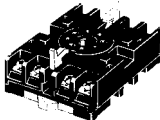
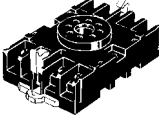
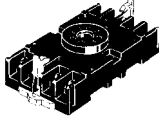
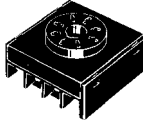
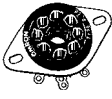
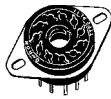

Item	PYF (Track-mounting) *see page 250	PY (back-connecting) *see page 252			PTF (Track-mounting) *see page 253	PT (back-connecting) *see page 255		
	Screw terminal	Solder terminal	Wrapping terminal	PCB terminal	Screw terminal	Solder terminal	Wrapping terminal	PCB terminal
11 pins	PYF11A Approx. 46 g 	PY11 Approx. 9 g  PY11-Y1 	PY11QN PY11QN2  PY11QN-Y1 PY11QN2-Y1 	PY11-02 	PTF11A Approx. 50 g 	PT11 Approx. 13 g 	PT11QN 	PT11-0 Approx. 12.2 g 
14 pins	PYF14A Approx. 49 g  PYF14A-E  PYF14A-N  PYF14T Approx. 53 g 	PY14 Approx. 10 g  PY14-Y1  PY14-Y2 	PY14QN PY14QN2 Approx. 14 g  PY14QN-Y1 PY14QN2-Y1 PY14QN-Y2 PY14QN2-Y2 	PY14-02 	PTF14A Approx. 60 g  PTF14A-E 	PT14 Approx. 17 g 	PT14QN Approx. 20 g 	PT14-0 Approx. 16.2 g 

Note: □-E and □-N Models are of finger-protect construction. Round terminals cannot be used. Use Y-shaped terminals.

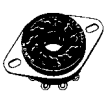
Item	P7LF (Track-mounting) *see page 256
	Screw terminal
6 pins	P7LF-06 Approx. 60 g 

Item	P7S *see page 257		
	Screw terminal (Track-mounting)	Solder terminal	PCB terminal
14 pins	P7S-14F Approx. 75 g 	P7S-14A Approx. 10 g 	P7S-14P Approx. 10 g 

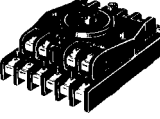
Round Sockets

Item	PF (Track-mounting) *see page 258	P2CF (Track-mounting)	PFA (Track-mounting)	P3G (Track-mounting)	PL (back-connecting) *see page 261		
					Solder terminal	Wrapping terminal	PCB terminal
8 pins	<p>PF083A Approx. 34 g</p>  <p>PF083A-E</p>  <p>PF085A Approx. 40 g</p> 	<p>P2CF-08 Approx. 55 g</p> 	<p>8PFA Approx. 57 g</p>  <p>8PFA1 Approx. 66 g</p> 	<p>P3G-08 Approx. 40 g</p> 	<p>PL08 Approx. 14 g</p> 	<p>PL08-Q Approx. 15 g</p> 	<p>PLE08-0 Approx. 10.6 g</p> 
11 pins	<p>PF113A Approx. 47 g</p>  <p>PF113A-E</p> 	<p>P2CF-11 Approx. 70 g</p> 	<p>11PFA Approx. 74 g</p> 	<p>P3GA-11 (see note) Approx. 47 g</p> 	<p>PL11 Approx. 15 g</p> 	<p>PL11-Q Approx. 18.5 g</p> 	<p>PLE11-0 Approx. 10.8 g</p> 
14 pins	---	---	<p>14PFA Approx. 104 g</p> 	---	<p>PL15 Approx. 28 g</p> 	---	---
20 pins	<p>PF202 Approx. 170 g</p> 	---	---	---	<p>PL20 Approx. 17 g</p> 	---	---

Note: This model succeeds the P3G-11 for which production was stopped in March 1991.

■ Hold-down Clips

For Square Sockets

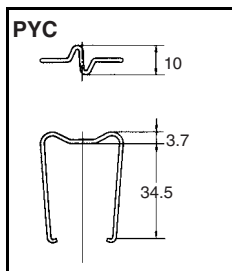
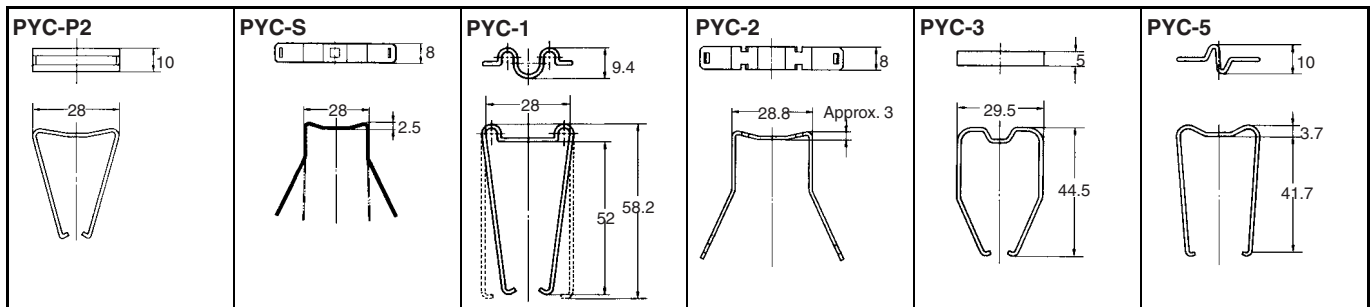
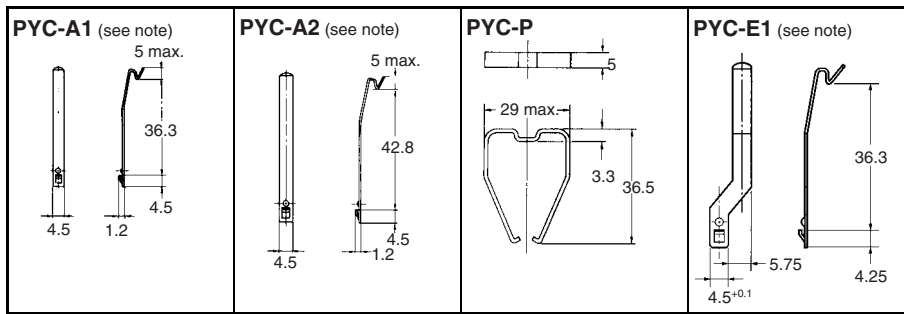

For Round Sockets

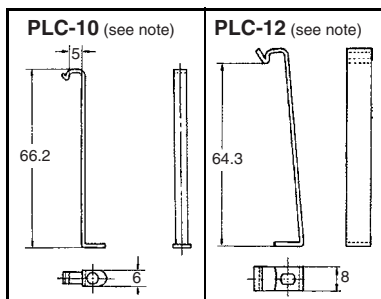
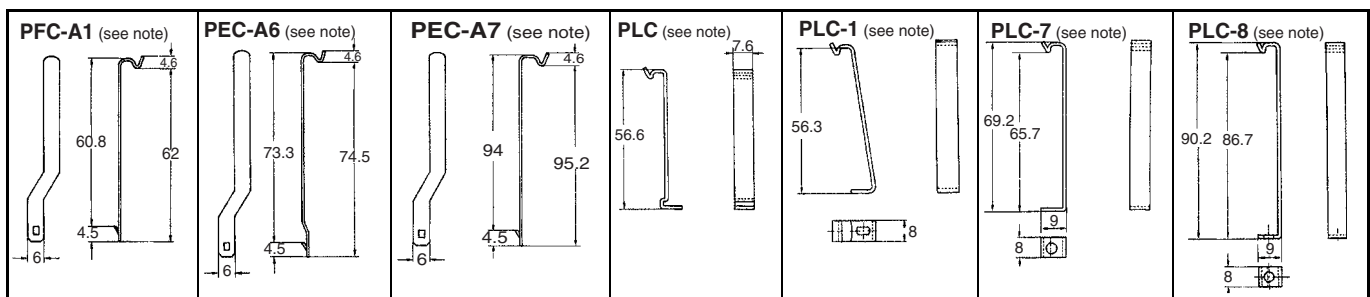

Note: There are 2 pieces per set.

■ Models Used with Sockets

Group	Model	Pin No.	Socket	
			Front-connecting	Back-connecting
MY(K)	MY2	8	PYF	PY
	MY3	11		
	MY4, MY2K	14		
LY	LY1, LY2	8	PTF	PT
	LY3	11		
	LY4	14		
G2A(K)	G2A, G2A-434, G2AK	14	PYF	PY
MK(K)	MK2P	8	PF083A(-E)	PL
	MK3P, MK2KP	11	PF113A(-E)	
MM(K)	MM2(X)P	8	8PFA	
	MM3P, MM2(X)KP	11	PFA	
	MM3XP, MM3(X)KP, MM4(X)P, MM4(X)KP	14		
G4Q	---	8	8PFA1	
G7L	G7L-□A-T(J)	6	P7LF	---

■ Models Used with Hold-down Clips

Square Sockets

Item	PYF□A(-E, -N), PTF□A(-E)	PY□(QN), PT□(QN)	PY□-02, PT□-0
MY(), MY()N, MY()N-D2, MY()N-CR, MY2K, LY(), LY()N, G3H, G3F, G3FD, G3FM	PYC-A1	PYC-P, PYC-S	PYC-P
MY4IN		PYC-P, PYC-P2	PYC-P, PYC-P2
MY2IN	PYC-E1	PYC-P2	PYC-P2
LY()-CR	Y92H-3	PYC-1	PYC-1
G2A(K) Series	PYC-A2	PYC-2, PYC-3, PYC-5	PYC-3, PYC-5

Note: Pin numbers 08, 11, or 14 apply to □.

Round Sockets

Item	PF083A, PF113A	PL08(-Q), PL11(-Q)	PLE08-0, PLE11-0
MK2P Series, MK2KP, MK3P□ (-US), G3B	PFC-A1	PLC	PLC-10
MK3ZP, MK3LP		PLC-1	
MYA-NA1, -NB1, MYA-LA1, -LB1, MYA-NA2, -NB2, MYA-LA2, -LB2	PFC-A6	PLC-7	---
MYA-LA12, -LB12	PFC-A7	PLC-8	---

Note: 1. 8PFA(I), 11PFA, and 14PFA has hooks that can hold a Relay.

2. PL15, PL20, PF202, and Sockets that are not listed in the above table should be mounted to a panel after opening mounting holes on the panel.
3. A Hold-down Clip for PF085A is sold together with Relays that can be used with PF085A.

■ Socket Performance Characteristics

Item	Carry current	Dielectric strength	Insulation resistance (see note 2)
P2RF-05(-E)	10 A	Between contacts of same polarity: 1,000 VAC for 1 min Between coil and contact: 4,000 VAC for 1 min	1,000 MΩ min.
P2RF-08(-E)	5 A	Between contact of different polarity: 3,000 VAC for 1 min Between contacts of same polarity: 1,000 VAC for 1 min Between coil and contact: 4,000 VAC for 1 min	1,000 MΩ min.
P2R-057P	10 A	Between contacts of same polarity: 1,000 VAC for 1 min Between coil and contact: 5,000 VAC for 1 min	1,000 MΩ min.
P2R-087P	5 A	Between contact of different polarity: 3,000 VAC for 1 min Between contacts of same polarity: 1,000 VAC for 1 min Between coil and contact: 5,000 VAC for 1 min	1,000 MΩ min.
P2R-05A	10 A	Between contacts of same polarity: 1,000 VAC for 1 min Between ground terminal and other terminals: 1,500 VAC for 1 min Between coil and contact: 4,000 VAC for 1 min	1,000 MΩ min.
P2R-08A	5 A	Between contact of different polarity: 3,000 VAC for 1 min Between contacts of same polarity: 1,000 VAC for 1 min Between ground terminal and other terminals: 1,500 VAC for 1 min Between coil and contact: 4,000 VAC for 1 min	1,000 MΩ min.
P7TF-05	5 A	Between terminals: 2,000 VAC for 1 min	100 MΩ min.
PYF08A-E	7 A	Between terminals: 2,000 VAC for 1 min	1,000 MΩ min.
PYF08A-N	7 A (see note 3)	Between terminals: 2,000 VAC for 1 min	1,000 MΩ min.
PYF11A	5 A	Between terminals: 2,000 VAC for 1 min	1,000 MΩ min.
PYF14A-E	5 A	Between terminals: 2,000 VAC for 1 min	1,000 MΩ min.
PYF14A-N	5 A (see note 3)	Between terminals: 2,000 VAC for 1 min	1,000 MΩ min.
PY08(-Y1)	7 A	Between terminals: 1,500 VAC for 1 min	100 MΩ min.
PY08QN(-Y1)	7 A	Between terminals: 1,500 VAC for 1 min	100 MΩ min.
PY08-02	7 A	Between terminals: 1,500 VAC for 1 min	100 MΩ min.
PY11(-Y1)	5 A	Between terminals: 1,500 VAC for 1 min	100 MΩ min.
PY11QN(-Y1)	5 A	Between terminals: 1,500 VAC for 1 min	100 MΩ min.
PY11-02	5 A	Between terminals: 1,500 VAC for 1 min	100 MΩ min.
PY14(-Y1)	3 A	Between terminals: 1,500 VAC for 1 min	100 MΩ min.
PY14QN(-Y1)	3 A	Between terminals: 1,500 VAC for 1 min	100 MΩ min.
PY14-02	3 A	Between terminals: 1,500 VAC for 1 min	100 MΩ min.
PTF□□A	10 A	Between terminals: 2,000 VAC for 1 min	100 MΩ min.
PT□□	10 A	Between terminals: 2,000 VAC for 1 min	100 MΩ min.
PT□□QN	10 A	Between terminals: 2,000 VAC for 1 min	100 MΩ min.
PT□□-0	10 A	Between terminals: 2,000 VAC for 1 min	100 MΩ min.

Item	Carry current	Dielectric strength	Insulation resistance (see note 2)
P7LF-06	30 A	Between contact of different polarity: 2,000 VAC for 1 min Between contacts of same polarity: 2,000 VAC for 1 min Between coil and contact: 4,000 VAC for 1 min	1,000 MΩ min.
PF□□□A	5 A	Between terminals: 2,000 VAC for 1 min	1,000 MΩ min.
P2CF	5 A	Between terminals: 2,000 VAC for 1 min	1,000 MΩ min.
P3G(A)	6 A	Between terminals: 2,000 VAC for 1 min	1,000 MΩ min.
8PFA(1)	10 A	Between terminals: 2,000 VAC for 1 min	1,000 MΩ min.
11PFA(1)	10 A	Between terminals: 2,000 VAC for 1 min	1,000 MΩ min.
PL□□(-Q)	10 A	Between terminals: 2,000 VAC for 1 min	1,000 MΩ min.
PLE□□-0	10 A	Between terminals: 2,000 VAC for 1 min	1,000 MΩ min.
P6D-04P	5 A	Between contacts of same polarity: 1,000 VAC for 1 min Between coil and contact: 3,000 VAC for 1 min	100 MΩ min.
P7S-14□	6 A	Between terminals: 2,500 VAC for 1 min Between ground terminal and other terminals (P7S-14A): 2,000 VAC for 1 min	100 MΩ min.

- Note:**
- The values given above are initial values.
 - The values for insulation resistance were measured at 500 V at the same place as the dielectric strength.
 - The maximum operating ambient temperature for the PYF08A-N and PYF14A-N is 55°C. When using the PYF08A-N or PYF14A-N at an operating ambient temperature exceeding 40°C, reduce the current to 60%.

Track and Accessories

Mounting Track

PFP-100N
PFP-50N

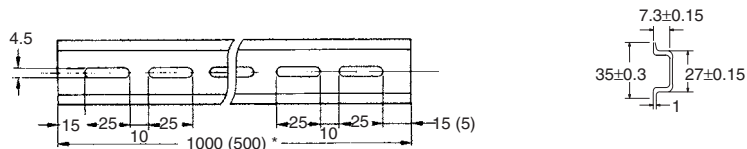
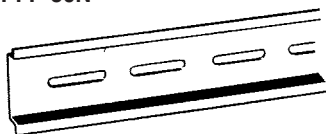

Note: The figure in the parentheses is for PFP-50N.

Mounting Track

PFP-100N2

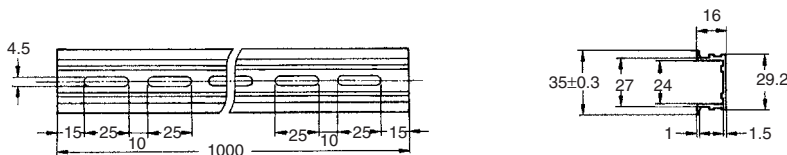
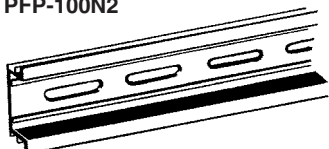

End Plate

PFP-M

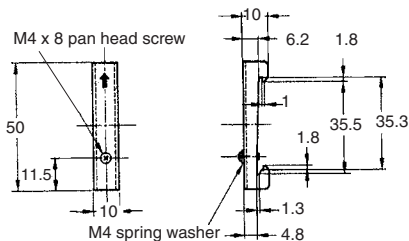
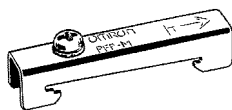

Spacer

PFP-S

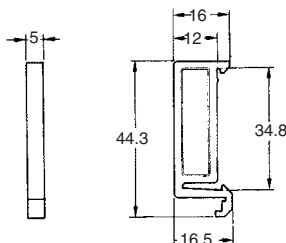
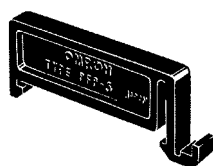

Dimensions

Note: All units are in millimeters unless otherwise indicated.

■ P2RF

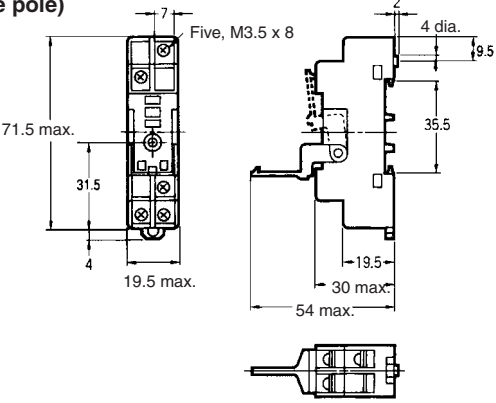
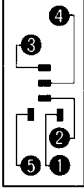
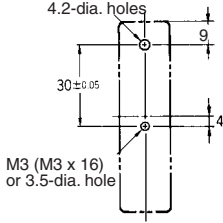
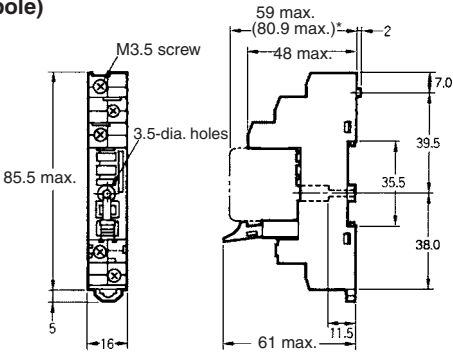
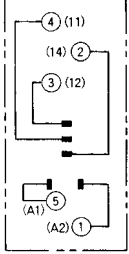
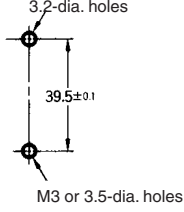
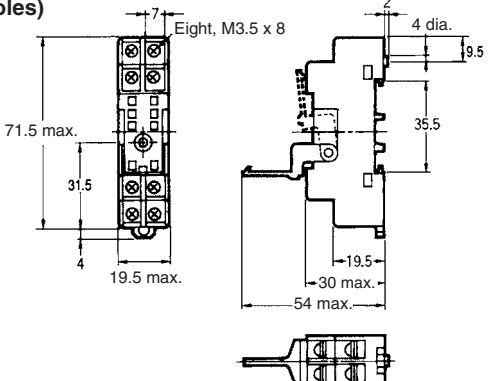
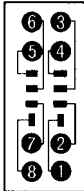
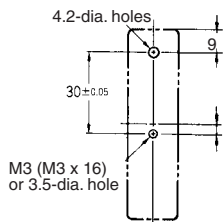
Dimensions	Terminal arrangement/Internal connections (top view)	Mounting holes (top view)
<p>P2RF-05 (One pole)</p>  <p>Five, M3.5 x 8</p>		 <p>Note: Track-mounting is also possible.</p>
<p>P2RF-05-E (One pole)</p>  <p>M3.5 screw</p> <p>* When mounted on H3RN-1□.</p>	 <p>Note: Figures in parentheses are DIN standard numbers.</p>	 <p>Note: Track-mounting is also possible.</p>
<p>P2RF-08 (Two poles)</p>  <p>Eight, M3.5 x 8</p>		 <p>Note: Track-mounting is also possible.</p>

Dimensions	Terminal arrangement/ Internal connections (top view)	Mounting holes (top view)
<p>P2RF-08-E (Two poles)</p> <p>* When mounted on H3RN-2□.</p>	<p>Note: Figures in parentheses are DIN standard numbers.</p>	<p>Note: Track-mounting is also possible.</p>

Note: When indicator modules with an I/O SSR are used, the No. 1 pin becomes positive.

■ P2R

Dimensions	Terminal arrangement/ Internal connections (bottom view)	Mounting holes (bottom view)
<p>P2R-05P (One pole)</p>		
<p>P2R-08P (Two poles)</p>		
<p>P2R-057P (One pole)</p>		
<p>P2R-087P (Two poles)</p>		

Note: When indicator modules with an I/O SSR are used, the No. 1 pin becomes positive.

■ P2R/P7TF

Dimensions	Terminal arrangement/ Internal connections	Mounting holes
<p>P2R-05A (One pole)</p> <p>Five, 3 x 1.8-dia. holes</p>	<p>(Bottom view)</p>	
<p>P2R-08A (Two poles)</p> <p>Eight, 3 x 1.2-dia. holes 1.5</p>	<p>(Bottom view)</p>	<p>Use panel with thickness of 1.6 to 2.0 mm.</p>
<p>P7TF-05</p> <p>Screw with square washer</p>	<p>(Top view)</p>	<p>Two, 3.0 dia.</p> <p>Note: Track-mounting is also possible.</p>

Note: When indicator modules with an I/O SSR are used, the No. 1 pin becomes positive.

■ PYF Dimensions

Dimensions	Terminal arrangement/ Internal connections (top view)	Mounting holes (top view)
<p>PYF08A</p> <p>Two, 4.2 x 5 mounting holes</p> <p>Eight, M3 x 8 sems screws</p> <p>72 max.</p> <p>23 max.</p> <p>3.4</p> <p>35.4</p> <p>16.5</p> <p>30 max.</p>		<p>Two, M3, M4, or 4.5-dia. holes</p> <p>59±0.3</p> <p>15±0.2</p> <p>Note: Track-mounting is also possible.</p>
<p>PYF08A-E</p> <p>Two, 4.2 x 5 mounting holes</p> <p>Eight, M3 x 8 sems</p> <p>72 max.</p> <p>23 max.</p> <p>3.4</p> <p>35.4</p> <p>16.5</p> <p>31 max.</p>		<p>Two, M3 or M4 (or 4.5-dia.) holes</p> <p>59±0.3</p> <p>15±0.1</p> <p>Note: Track-mounting is also possible.</p>
<p>PYF08A-N</p> <p>22 max.</p> <p>67 max.</p> <p>73</p> <p>30 max.</p>		<p>3.0 dia.</p> <p>18.7</p> <p>3.5 dia. or M3</p> <p>Note: Track-mounting is also possible. Refer to page 245 for Mounting Tracks.</p>
<p>PYF11A</p> <p>Two, 4.2 x 5 mounting holes</p> <p>Eleven, M3 x 8 sems</p> <p>72 max.</p> <p>29.5 max.</p> <p>3.4</p> <p>35.4</p> <p>16.5</p> <p>30 max.</p>		<p>Two, M3 or M4 (or 4.5-dia.) holes</p> <p>59±0.3</p> <p>22±0.2</p> <p>Note: Track-mounting is also possible.</p>

Dimensions	Terminal arrangement/ Internal connections (top view)	Mounting holes (top view)
<p>PYF14A</p> <p>Two, 4.2 x 5 mounting holes</p> <p>72 max.</p> <p>29.5 max.</p> <p>Fourteen, M3 x 8 sems</p> <p>30 max.</p> <p>35.4</p> <p>3.4</p> <p>16.5</p> <p>6</p> <p>4</p>		<p>Two, M3 or M4 (or 4.5-dia.) holes</p> <p>59±0.3</p> <p>22±0.2</p>
<p>PYF14A-E</p> <p>Two, 4.2 x 5 mounting holes</p> <p>72 max.</p> <p>29.5 max.</p> <p>Fourteen, M3 x 8 sems</p> <p>31 max.</p> <p>35.4</p> <p>3.4</p> <p>16.5</p> <p>6</p> <p>4</p>		<p>Note: Track-mounting is also possible.</p>
<p>PYF14A-N</p> <p>67 max.</p> <p>73</p> <p>29.5 max.</p> <p>30 max.</p>	<p>42 32 22 12</p> <p>44 34 24 14</p> <p>8 7 6 5</p> <p>12 11 10 9</p> <p>41 31 21 11</p> <p>14 14 13</p> <p>A2 A2 A1</p>	<p>Two, 4.5 dia. or M4</p> <p>26</p> <p>Note: Track-mounting is also possible. Refer to page 245 for Mounting Tracks.</p>
<p>PYF14T</p> <p>Two, 4.2 x 5 dia. mounting holes</p> <p>70 max.</p> <p>33 max.</p> <p>30 max.</p> <p>35.5</p> <p>17.8</p> <p>Fourteen, M3 x 8 sems</p>		<p>Two, M4</p> <p>59</p> <p>24.5</p> <p>Note: Track-mounting is also possible.</p>

■ PY Dimensions

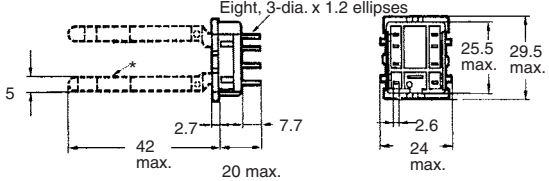
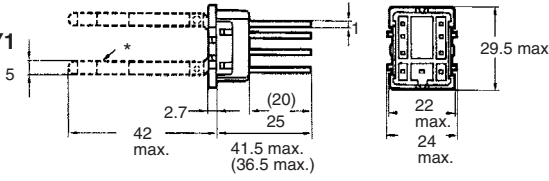
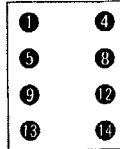
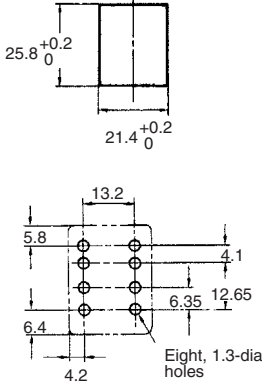
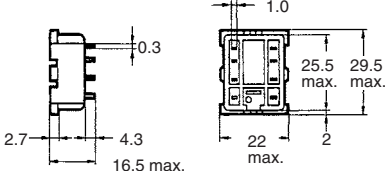
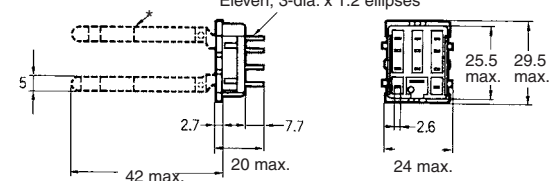
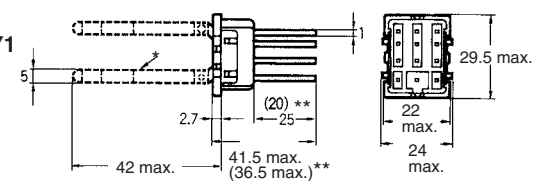
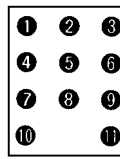
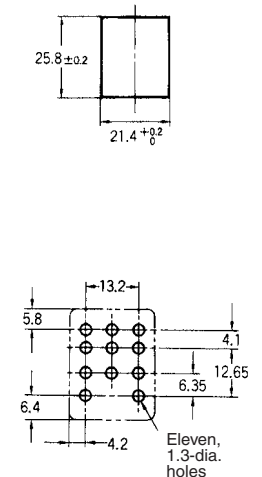
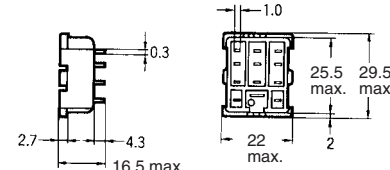
Dimensions	Terminal arrangement/ Internal connections (bottom view)	Mounting holes
<p>PY08 PY08-Y1 PY08-Y3</p>  <p>Note: PY08-Y1 includes the part outlined by the dashed lines above.</p>		
<p>PY08QN PY08QN2 PY08QN-Y1 PY08QN2-Y1</p>  <p>Note: 1. PY08QN(2)-Y1 includes the part outlined by the dashed lines above. 2. The figures in the parentheses are for PY08QN2.</p>		
<p>PY08-02</p>  <p>Note: PY08-Y1 includes the part outlined by the dashed lines above.</p>		
<p>PY11 PY11-Y1</p>  <p>Note: PY11-Y1 includes the part outlined by the dashed lines above.</p>		
<p>PY11QN PY11QN2 PY11QN-Y1 PY11QN2-Y1</p>  <p>Note: 1. PY11QN(2)-Y1 includes the part outlined by the dashed lines above. 2. The figures in the parentheses are for PY11QN2 (-Y1).</p>		
<p>PY11-02</p> 		

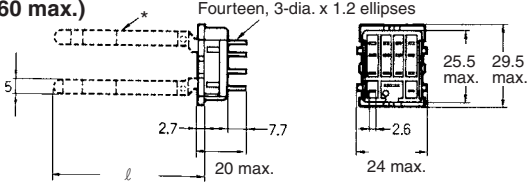
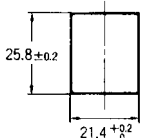
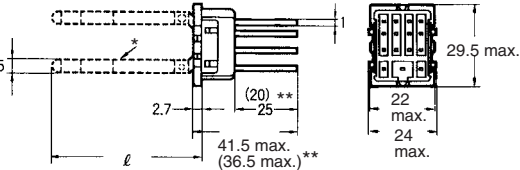
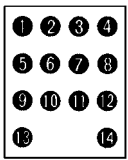
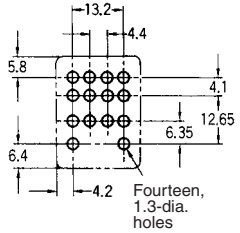
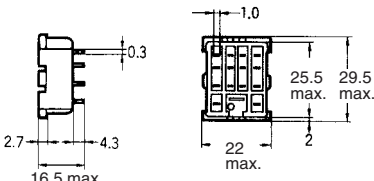
Dimensions	Terminal arrangement/ Internal connections (bottom view)	Mounting holes
<p>PY14 PY14-Y1 ($\ell=42$ max.) PY14-Y3 ($\ell=60$ max.)</p>  <p>Fourteen, 3-dia. x 1.2 ellipses</p> <p>Note: PY14-Y1 includes the part outlined by the dashed lines above.</p>		
<p>PY14QN, PY14QN2 PY14QN-Y1 ($\ell=42$ max.) PY14QN2-Y1 ($\ell=42$ max.) PY14QN-Y2 ($\ell=49$ max.) PY14QN2-Y2 ($\ell=49$ max.) PY14QN-Y3 ($\ell=60$ max.) PY14QN2-Y3 ($\ell=60$ max.)</p>  <p>Note: 1. PY14QN(2)-Y1 includes the part outlined by the dashed lines above. 2. The figures in the parentheses are for PY14QN2 (-Y1).</p>		 <p>Fourteen, 1.3-dia. holes</p>
<p>PY14-02</p> 		

- Note:**
1. Use a panel with a thickness of 1 to 2 mm when mounting a Socket on it.
 2. The PY14-Y1 and the PY14QN-Y1 can be used with MY4-series models and the MY2K.

PTF Dimensions

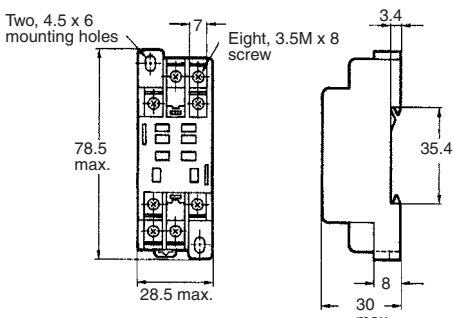
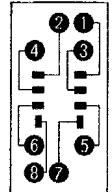
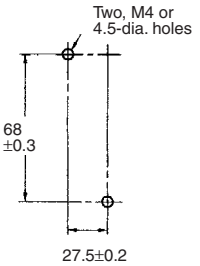
Dimensions	Terminal arrangement/ Internal connections (top view)	Mounting holes (top view)
<p>PTF08A</p>  <p>Two, 4.5 x 6 mounting holes</p> <p>Eight, 3.5M x 8 screw</p>		 <p>Two, M4 or 4.5-dia. holes</p> <p>Note: Track-mounting is available. See page 245.</p>

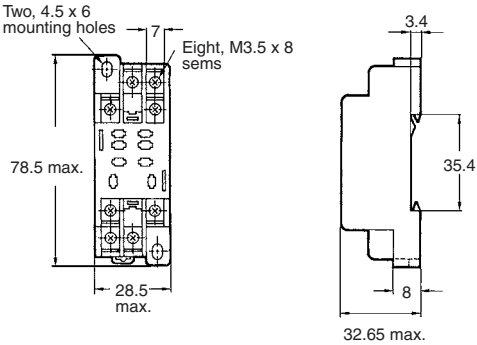
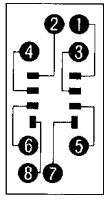
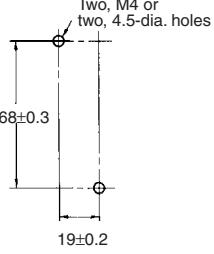
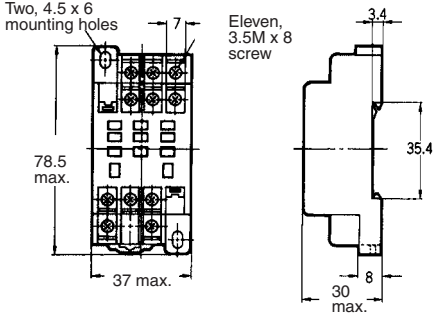
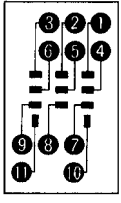
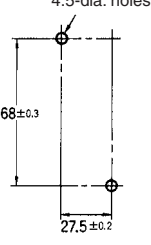
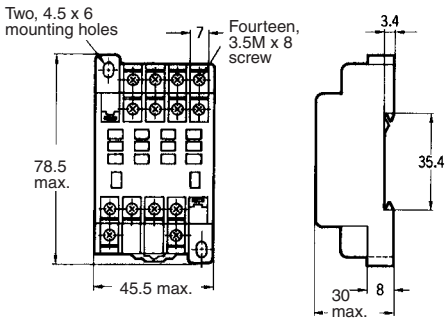
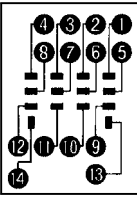
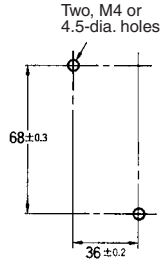
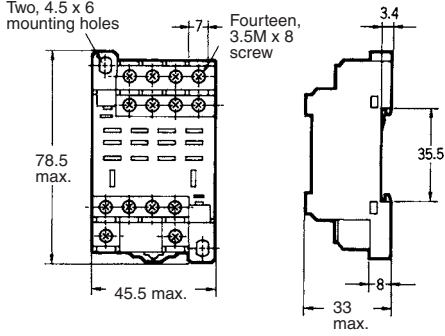
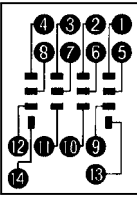
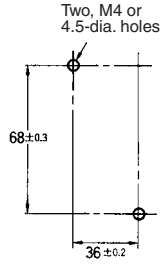
Dimensions	Terminal arrangement/ Internal connections (top view)	Mounting holes (top view)
<p>PTF08A-E</p>  <p>Two, 4.5 x 6 mounting holes</p> <p>Eight, M3.5 x 8 sems</p> <p>78.5 max.</p> <p>28.5 max.</p> <p>3.4</p> <p>35.4</p> <p>8</p> <p>32.65 max.</p>		 <p>Two, M4 or 4.5-dia. holes</p> <p>68±0.3</p> <p>19±0.2</p> <p>Note: Track-mounting is available. See page 245.</p>
<p>PTF11A</p>  <p>Two, 4.5 x 6 mounting holes</p> <p>Eleven, 3.5M x 8 screw</p> <p>78.5 max.</p> <p>37 max.</p> <p>3.4</p> <p>35.4</p> <p>8</p> <p>30 max.</p>		 <p>Two, M4 or 4.5-dia. holes</p> <p>68±0.3</p> <p>27.5±0.2</p> <p>Note: Track-mounting is available. See page 245.</p>
<p>PTF14A</p>  <p>Two, 4.5 x 6 mounting holes</p> <p>Fourteen, 3.5M x 8 screw</p> <p>78.5 max.</p> <p>45.5 max.</p> <p>3.4</p> <p>35.4</p> <p>8</p> <p>30 max.</p>		 <p>Two, M4 or 4.5-dia. holes</p> <p>68±0.3</p> <p>36±0.2</p>
<p>PTF14A-E</p>  <p>Two, 4.5 x 6 mounting holes</p> <p>Fourteen, 3.5M x 8 screw</p> <p>78.5 max.</p> <p>45.5 max.</p> <p>3.4</p> <p>35.5</p> <p>8</p> <p>33 max.</p>		 <p>Two, M4 or 4.5-dia. holes</p> <p>68±0.3</p> <p>36±0.2</p> <p>Note: Track-mounting is available. See page 245.</p>

Note: If PTF08A and PT08 are used in combination with LY1 with a total current flow of 10 A minimum, terminals 1 and 2, 3 and 4, 5 and 6 respectively should be short-circuited.

■ PT Dimensions

Dimensions	Terminal arrangement/ Internal connections (bottom view)	Mounting holes
<p>PT08</p> <p>Eight, 1.7-dia. x 3.5 ellipses</p>		
<p>PT08-0</p> <p>*Keep a proper distance between the Socket and PCB patterns.</p>		<p>The tolerance is ± 0.1.</p>
<p>PT11</p> <p>Eleven, 1.7-dia. x 3.5 holes</p>		
<p>PT11-0</p> <p>*Keep a proper distance between the Socket and PCB patterns.</p>		<p>The tolerance is ± 0.1.</p>

Dimensions	Terminal arrangement/ Internal connections (bottom view)	Mounting holes
<p>PT14</p> <p>PT14QN</p>		
<p>PT14-0</p> <p>*Keep a proper distance between the Socket and PCB patterns.</p>		<p>The tolerance is ± 0.1.</p>

Note: Use a panel with a thickness of 1 to 2 mm when mounting a Socket on it.

■ P7LF Dimensions

Dimensions	Terminal arrangement/ Internal connections (top view)	Mounting holes
<p>P7LF-06</p> <p>Two, M3.5 (coil side)</p> <p>Four, M4 (contact side)</p>		

■ P7S Dimensions

Dimensions	Terminal arrangement/ Internal connections	Mounting holes
<p>P7S-14F</p> <p>40 max. 33±0.1 Fourteen, M3.0 47 max. 90.5 max. 40 max.</p>	<p>(top view)</p>	<p>Two, M3.5 or 4.0-dia. holes 33±0.1</p>
<p>P7S-14A</p> <p>61.5 max. 23 max. 33 max. 5x7=35 14.5</p>	<p>G7S-4A2B</p> <p>G7S-3A3B</p> <p>(bottom view)</p>	<p>21±0.2 57±0.2</p>
<p>P7S-14P</p> <p>61.5 max. 23 max. 29 max. Two, 6.5 dia. x 7.9 5x7=35 14.5</p>	<p>G7S-4A2B</p> <p>G7S-3A3B</p> <p>(bottom view)</p>	<p>4.2 2.8 16.4 12.2 14.5 6 28±0.2 17 6 5x7=35 7 Two, 6.5 dia. Fourteen, 1.8 dia.</p>

■ PF Dimensions

Dimensions	Terminal arrangement/ Internal connections (top view)	Mounting holes
<p>PF083A</p> <p>Eight, M3.5 x 7 sems screws</p> <p>Two, 4.2-dia. holes</p> <p>52 max.</p> <p>41 max.</p> <p>33</p> <p>4</p> <p>7</p> <p>35.4</p> <p>4</p> <p>3.5</p> <p>2</p> <p>21 max.</p>		<p>Two, M4 or 4.5-dia. holes</p> <p>33±0.2</p> <p>Note: Track-mounting is available. See page 245.</p>
<p>PF083A-E</p> <p>Eight, M3.5 x 7 sems</p> <p>Two, 4.2-dia. holes</p> <p>52 max.</p> <p>41 max.</p> <p>33</p> <p>4</p> <p>7</p> <p>35.4</p> <p>4</p> <p>3.5</p> <p>2</p> <p>21 max.</p>		<p>Two, M4 or two, 4.5-dia. holes</p> <p>33±0.2</p>
<p>PF085A</p> <p>Eight, M3.5 x 7 sems screws</p> <p>Two, 4.5-dia. holes</p> <p>58 max.</p> <p>40 max.</p> <p>33±0.2</p> <p>4</p> <p>7</p> <p>35.4</p> <p>4</p> <p>1.1</p> <p>3.5</p> <p>2</p> <p>21.6 max.</p>		<p>Two, M4 or 4.5-dia. holes</p> <p>33±0.2</p> <p>Note: Track-mounting is available. See page 245.</p>
<p>PF113A</p> <p>Eight, M3.5 x 7 sems screws</p> <p>Two, 4.2-dia. holes</p> <p>52 max.</p> <p>41 max.</p> <p>34</p> <p>4</p> <p>7</p> <p>35.4</p> <p>4</p> <p>3.5</p> <p>2</p> <p>21 max.</p>		<p>Two, M4 or 4.5-dia. holes</p> <p>34±0.2</p>
<p>PF113A-E</p> <p>Eight, M3.5 x 7 sems</p> <p>Two, 4.2-dia. holes</p> <p>52 max.</p> <p>42.8 max.</p> <p>34</p> <p>4</p> <p>7±0.2</p> <p>8</p> <p>35.4</p> <p>4</p> <p>3.5</p> <p>5.5</p> <p>21 max.</p>		<p>Two, M4 or 4.5-dia. holes</p> <p>34±0.2</p> <p>Note: Track-mounting is available. See page 245.</p>

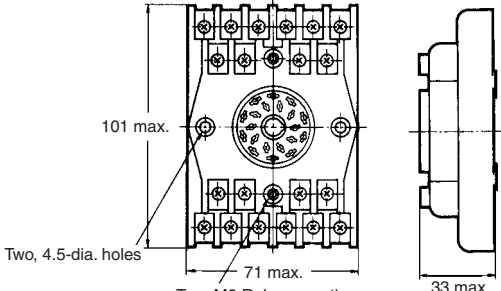
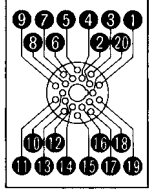
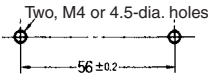
Dimensions	Terminal arrangement/ Internal connections (top view)	Mounting holes
<p>PF202</p>  <p>101 max.</p> <p>Two, 4.5-dia. holes</p> <p>71 max.</p> <p>Two, M3 Relay mounting screws</p> <p>33 max.</p>		 <p>Two, M4 or 4.5-dia. holes</p> <p>56 ± 0.2</p>

Note: The key groove of PF083A and PF113A (used with MK Relays) are on the upside.

■ P2CF/PFA Dimensions

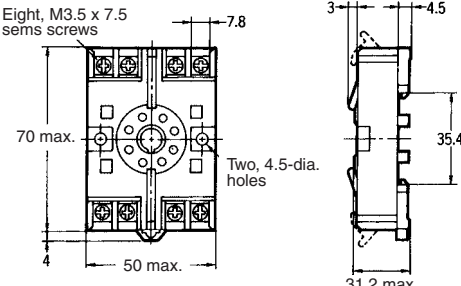
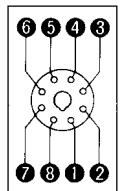
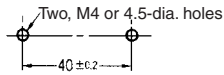
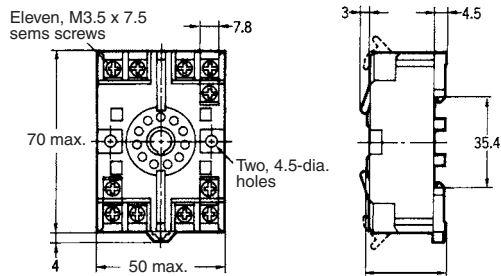
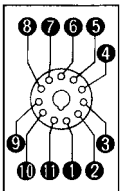
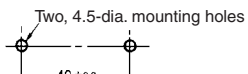
Dimensions	Terminal arrangement/ Internal connections (top view)	Mounting holes
<p>P2CF-08</p>  <p>Eight, M3.5 x 7.5 sems screws</p> <p>7.8</p> <p>70 max.</p> <p>Two, 4.5-dia. holes</p> <p>4</p> <p>50 max.</p> <p>3</p> <p>4.5</p> <p>35.4</p> <p>31.2 max.</p>		 <p>Two, M4 or 4.5-dia. holes</p> <p>40 ± 0.2</p> <p>Note: Track-mounting is available. See page 245.</p>
<p>P2CF-11</p>  <p>Eleven, M3.5 x 7.5 sems screws</p> <p>7.8</p> <p>70 max.</p> <p>Two, 4.5-dia. holes</p> <p>4</p> <p>50 max.</p> <p>3</p> <p>4.5</p> <p>35.4</p> <p>31.2 max.</p>		 <p>Two, 4.5-dia. mounting holes</p> <p>40 ± 0.2</p> <p>Note: Track-mounting is available. See page 245.</p>

Dimensions	Terminal arrangement/ Internal connections (top view)	Mounting holes
<p>8PFA</p>		<p>Note: Track-mounting is available. See page 245.</p>
<p>8PFA1</p>		<p>Note: Track-mounting is available. See page 245.</p>

■ PFA/P3G/P3GA Dimensions

Dimensions	Terminal arrangement/ Internal connections (top view)	Mounting holes
<p>11PFA</p>		<p>Note: Track-mounting is available. See page 245.</p>
<p>14PFA</p>		<p>Note: Track-mounting is available. See page 245.</p>

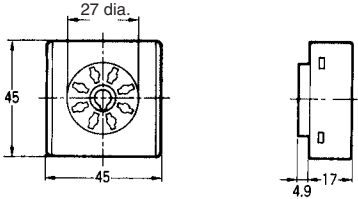
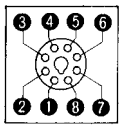
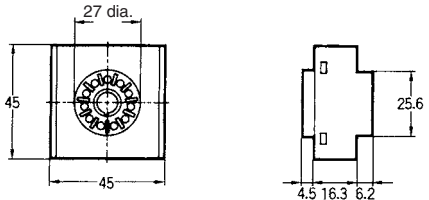
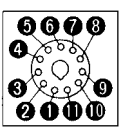

Dimensions	Terminal arrangement/ Internal connections (top view)	Mounting holes
P3G-08 		---
P3GA-11 		---

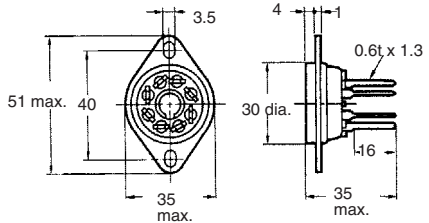
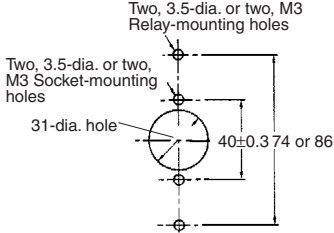
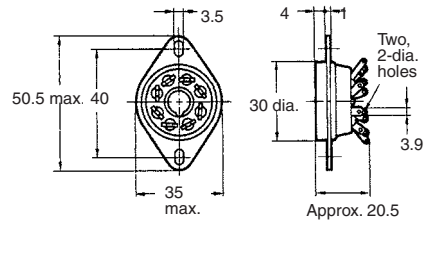
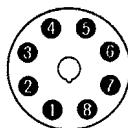
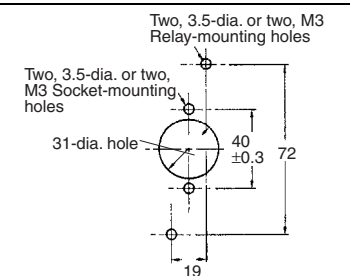
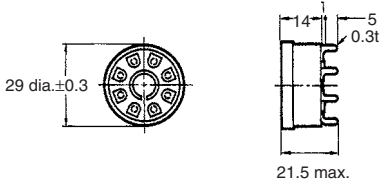
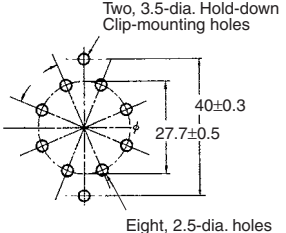
■ PL Dimensions

Dimensions	Terminal arrangement/ Internal connections (bottom view)	Mounting holes
PL08 		
PL08-Q 		
PLE08-0 		

Note: When mounting, pay due attention to the direction of the key groove of applicable Relays.

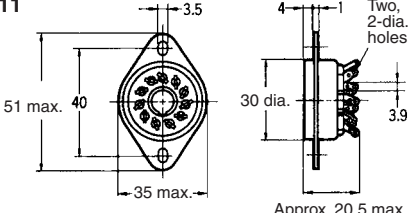
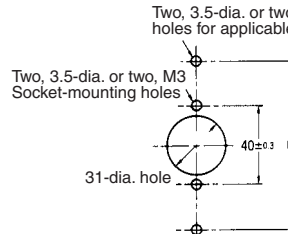
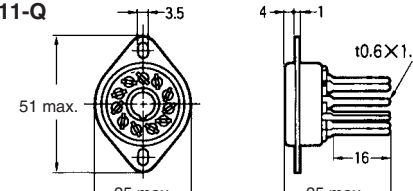
■ PL Dimensions

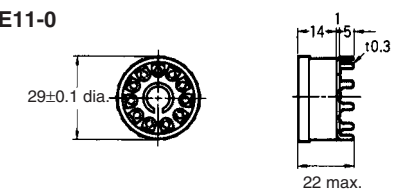
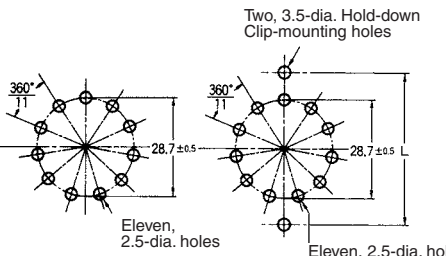
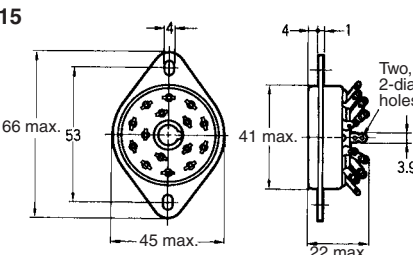
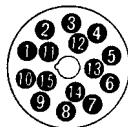
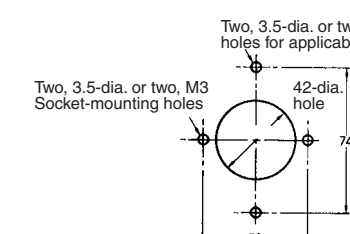
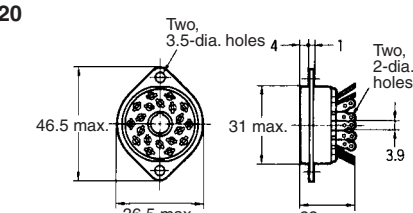
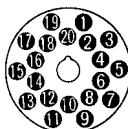
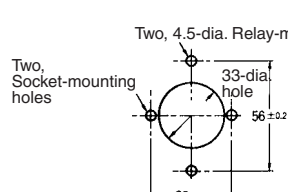
Dimensions	Terminal arrangement/ Internal connections (bottom view)	Mounting holes
<p>PL11</p>  <p>3.5 51 max. 40 35 max. 30 dia. 3.9 Two, 2-dia. holes Approx. 20.5 max. 4 1</p>		<p>Two, 3.5-dia. or two, M3-mounting holes for applicable models</p>  <p>Two, 3.5-dia. or two, M3 Socket-mounting holes 31-dia. hole 40±0.3 L=40 mm MK3P, MK2KP, MK3ZP, MK3LP L=74 mm MM3P, MM2(X)KP</p>
<p>PL11-Q</p>  <p>3.5 51 max. 35 max. 10.6X1.3 16 35 max. 4 1</p>		
<p>PLE11-0</p>  <p>29±0.1 dia. 14 5 10.3 22 max.</p>		<p>Two, 3.5-dia. Hold-down Clip-mounting holes</p>  <p>360° 28.7±0.5 360° 28.7±0.5 Eleven, 2.5-dia. holes Eleven, 2.5-dia. holes MK3P MK2KP L= Distance between mounting holes required for MK</p>
<p>PL15</p>  <p>3.5 66 max. 53 45 max. 41 max. 3.9 Two, 2-dia. holes 22 max. 4 1</p>		<p>Two, 3.5-dia. or two, M3-mounting holes for applicable models</p>  <p>Two, 3.5-dia. or two, M3 Socket-mounting holes 42-dia. hole 74 53 MK3XP, MM4(X)P, MM3(X)KP, MM4(X)KP</p>
<p>PL20</p>  <p>3.5 46.5 max. 36.5 max. 31 max. 3.9 Two, 2-dia. holes 23 max. 4 1 Two, 3.5-dia. holes</p>		<p>Two, 4.5-dia. Relay-mounting holes</p>  <p>Two, 4.5-dia. Relay-mounting holes 33-dia. hole 56±0.2 38±0.2 Two, Socket-mounting holes Note: Mounting hole preparation not required for LDNP.</p>

ALL DIMENSIONS SHOWN ARE IN MILLIMETERS.

To convert millimeters into inches, multiply by 0.03937. To convert grams into ounces, multiply by 0.03527.

Read and Understand This Catalog

Please read and understand this catalog before purchasing the products. Please consult your OMRON representative if you have any questions or comments.

Warranty and Limitations of Liability

WARRANTY

OMRON's exclusive warranty is that the products are free from defects in materials and workmanship for a period of one year (or other period if specified) from date of sale by OMRON.

OMRON MAKES NO WARRANTY OR REPRESENTATION, EXPRESS OR IMPLIED, REGARDING NON-INFRINGEMENT, MERCHANTABILITY, OR FITNESS FOR PARTICULAR PURPOSE OF THE PRODUCTS. ANY BUYER OR USER ACKNOWLEDGES THAT THE BUYER OR USER ALONE HAS DETERMINED THAT THE PRODUCTS WILL SUITABLY MEET THE REQUIREMENTS OF THEIR INTENDED USE. OMRON DISCLAIMS ALL OTHER WARRANTIES, EXPRESS OR IMPLIED.

LIMITATIONS OF LIABILITY

OMRON SHALL NOT BE RESPONSIBLE FOR SPECIAL, INDIRECT, OR CONSEQUENTIAL DAMAGES, LOSS OF PROFITS OR COMMERCIAL LOSS IN ANY WAY CONNECTED WITH THE PRODUCTS, WHETHER SUCH CLAIM IS BASED ON CONTRACT, WARRANTY, NEGLIGENCE, OR STRICT LIABILITY.

In no event shall the responsibility of OMRON for any act exceed the individual price of the product on which liability is asserted.

IN NO EVENT SHALL OMRON BE RESPONSIBLE FOR WARRANTY, REPAIR, OR OTHER CLAIMS REGARDING THE PRODUCTS UNLESS OMRON'S ANALYSIS CONFIRMS THAT THE PRODUCTS WERE PROPERLY HANDLED, STORED, INSTALLED, AND MAINTAINED AND NOT SUBJECT TO CONTAMINATION, ABUSE, MISUSE, OR INAPPROPRIATE MODIFICATION OR REPAIR.

Application Considerations

SUITABILITY FOR USE

OMRON shall not be responsible for conformity with any standards, codes, or regulations that apply to the combination of products in the customer's application or use of the products.

At the customer's request, OMRON will provide applicable third party certification documents identifying ratings and limitations of use that apply to the products. This information by itself is not sufficient for a complete determination of the suitability of the products in combination with the end product, machine, system, or other application or use.

The following are some examples of applications for which particular attention must be given. This is not intended to be an exhaustive list of all possible uses of the products, nor is it intended to imply that the uses listed may be suitable for the products:

- Outdoor use, uses involving potential chemical contamination or electrical interference, or conditions or uses not described in this catalog.
- Nuclear energy control systems, combustion systems, railroad systems, aviation systems, medical equipment, amusement machines, vehicles, safety equipment, and installations subject to separate industry or government regulations.
- Systems, machines, and equipment that could present a risk to life or property.

Please know and observe all prohibitions of use applicable to the products.

NEVER USE THE PRODUCTS FOR AN APPLICATION INVOLVING SERIOUS RISK TO LIFE OR PROPERTY WITHOUT ENSURING THAT THE SYSTEM AS A WHOLE HAS BEEN DESIGNED TO ADDRESS THE RISKS, AND THAT THE OMRON PRODUCTS ARE PROPERLY RATED AND INSTALLED FOR THE INTENDED USE WITHIN THE OVERALL EQUIPMENT OR SYSTEM.

PROGRAMMABLE PRODUCTS

OMRON shall not be responsible for the user's programming of a programmable product, or any consequence thereof.

Disclaimers

CHANGE IN SPECIFICATIONS

Product specifications and accessories may be changed at any time based on improvements and other reasons.

It is our practice to change model numbers when published ratings or features are changed, or when significant construction changes are made. However, some specifications of the products may be changed without any notice. When in doubt, special model numbers may be assigned to fix or establish key specifications for your application on your request. Please consult with your OMRON representative at any time to confirm actual specifications of purchased products.

DIMENSIONS AND WEIGHTS

Dimensions and weights are nominal and are not to be used for manufacturing purposes, even when tolerances are shown.

PERFORMANCE DATA

Performance data given in this catalog is provided as a guide for the user in determining suitability and does not constitute a warranty. It may represent the result of OMRON's test conditions, and the users must correlate it to actual application requirements. Actual performance is subject to the OMRON Warranty and Limitations of Liability.

ERRORS AND OMISSIONS

The information in this document has been carefully checked and is believed to be accurate; however, no responsibility is assumed for clerical, typographical, or proofreading errors, or omissions.



OMRON ELECTRONICS LLC • THE AMERICAS HEADQUARTERS • Schaumburg, IL USA • 847.843.7900 • 800.556.6766 • www.omron247.com

OMRON CANADA, INC. • HEAD OFFICE

Toronto, ON, Canada • 416.286.6465 • 866.986.6766
www.omron247.com

OMRON ELETRÔNICA DO BRASIL LTDA • HEAD OFFICE

São Paulo, SP, Brasil • 55.11.2101.6300 • www.omron.com.br

OMRON ELECTRONICS MEXICO SA DE CV • HEAD OFFICE

Apodaca, N.L. • 52.811.156.99.10 • 001.800.556.6766 • mela@omron.com

OMRON ARGENTINA • SALES OFFICE

Cono Sur • 54.11.4783.5300

OMRON CHILE • SALES OFFICE

Santiago • 56.9.9917.3920

OTHER OMRON LATIN AMERICA SALES

54.11.4783.5300

OMRON EUROPE B.V. Wegalaan 67-69, NL-2132 JD, Hoofddorp, The Netherlands. Tel: +31 (0) 23 568 13 00 Fax: +31 (0) 23 568 13 88 www.industrial.omron.eu