

NGR



SVR



Rockette



EURO SR



ESPORT



2.1 Introduction	
Product Selection Guide	V11-T2-3
2.2 NGR	
Product Description	V11-T2-8
Catalog Number Selection	V11-T2-10
2.3 SVR	
Product Description	V11-T2-32
Catalog Number Selection	V11-T2-34
2.4 Dual Motion Safety Switch	
Product Description	V11-T2-41
Catalog Number Selection	V11-T2-42
2.5 1500/2500	
Product Description	V11-T2-43
Catalog Number Selection	V11-T2-44
2.6 1600/2600	
Product Description	V11-T2-47
Catalog Number Selection	V11-T2-48
2.7 Rockette	
Product Description	V11-T2-54
Catalog Number Selection	V11-T2-55
2.8 8006/8007—EURO SR	
Product Description	V11-T2-62
Catalog Number Selection	V11-T2-63
2.9 8004/8005—Euro Full Size	
Product Description	V11-T2-65
Catalog Number Selection	V11-T2-66
2.10 X Series	
Product Description	V11-T2-68
Catalog Number Selection	V11-T2-69
X Series Symbols Library	V11-T2-70
2.11 8064/8065 ESPORT	
Product Description	V11-T2-72
Catalog Number Selection	V11-T2-73
Icon/Legend Selection	V11-T2-74
2.12 Accessories	
Dimensions	V11-T2-76
2.13 Technical Data	
Rocker, Toggle and Pushbuttons	V11-T2-78
Rocker Switch Circuit Diagrams	V11-T2-79
2.14 Symbol Library	
NGR, SVR, E31, E32 and E33 eSM Symbols	V11-T2-80
NGR Only Symbols	V11-T2-85
SVR, E31, E32 and E33 eSM Symbols	V11-T2-95

Rocker Switch Products

2



Contents

Description

Rocker Selection Guide	V11-T2-3
NGR Rocker Switches	V11-T2-8
SVR—Sealed Vehicle Rockers	V11-T2-32
Dual Motion Safety Switches	V11-T2-41
1500/2500—Midsize AC Rated	V11-T2-43
1600/2600—Midsize AC Only	V11-T2-47
Rockette—General Purpose AC Rated	V11-T2-54
8006/8007—EURO SR	V11-T2-62
8004/8005—Euro Full Size	V11-T2-65
X Series Rockers	V11-T2-68
8064/8065—ESPORT	V11-T2-72
Accessories	V11-T2-76
Technical Data	V11-T2-78
Symbols Library	V11-T2-80

Rocker Selection Guide

See Technical Data and Dimensions for more details.

Rocker Switches—Illuminated and Non-Illuminated

NGR

SVR



Features

Ratings	15A at 125 Vac, 10A at 250 Vac; 15A at 28 Vdc (14 Vdc rating)	12A at either 12 or 24 Vdc
Certifications	RoHS, UL® Approvable	RoHS, UL Approvable
Panel Opening	Rectangular	Octagonal
Single- and two-pole length	1.734 in (44.04 ± 0.13 mm)	0.830 in (21.10 mm); 0.680 in (17.30 mm)
Single-pole width	0.867 in (22.02 ± 0.13 mm)	1.450 in (36.80 mm); 1.190 in (30.20 mm)
Two-pole width	0.867 in (22.02 ± 0.13 mm)	1.450 in (36.80 mm); 1.190 in (30.20 mm)
Seal		
Top (internal)	✓	✓
Bottom (internal)	—	✓
Panel	✓	✓
Actuator		
Rocker without bezel	—	✓
Rocker with bezel	✓	✓
Paddle	✓	✓
Snap-in lens	✓	✓
Locking	✓	—
Label	✓	—
Decorative		
Laser-etch	✓	✓
Pad-print	✓	✓
Poles		
Single	✓	✓
Double	✓	✓
Four	—	—
Termination		
Spade	✓	✓
Solder	—	—
Screw	—	—
Weld lugs	—	—
Illumination		
Incandescent 6 Vdc	—	—
Incandescent 12 Vdc	—	—
Incandescent 14 Vdc	✓	—
Incandescent 18 Vdc	✓	—
Incandescent 24 Vdc	—	—
Incandescent 28 Vdc	✓	—
Neon 110V	—	—
Neon 125V	—	—
Neon 250V	—	—
14V LED	✓	✓
28V LED	✓	✓
Catalog Number Selection	Page V11-T2-10	Page V11-T2-34
Technical Data	Page V11-T2-16	Page V11-T2-36
Circuit Diagrams	Page V11-T2-17	Page V11-T2-37
Dimensions	Page V11-T2-30	Page V11-T2-38
Icon/Legend Symbols Library	Page V11-T2-80	Page V11-T2-80

See Technical Data and Dimensions for more details.

Rocker Switches—Illuminated and Non-Illuminated, continued

2

Dual Motion Safety Switch

1500/2500



Features

Ratings	10A at 250 Vac, 15A at 125 Vac, 3/4 hp at 250 Vac	Up to 22A at 125 Vac, 16A at 250 Vac
Certifications	UL, CSA®, RoHS	UL, CSA, ENEC, RoHS
Panel Opening	Octagonal	Rectangular
Single- and two-pole length	1.450 in (36.80 mm); 1.190 in (30.20 mm)	1.075 in (27.30 ± 0.10 mm)
Single-pole width	0.830 in (21.10 mm); 0.680 in (17.20 mm)	0.483 in (12.27 ± 0.07 mm)
Two-pole width	N/A	0.876 in (22.25 ± 0.10 mm)
Seal		
Top (internal)	—	—
Bottom (internal)	—	—
Panel	—	—
Actuator		
Rocker without bezel	—	—
Rocker with bezel	✓	✓
Paddle	✓	✓
Snap-in lens	—	—
Locking	—	—
Label	—	—
Decorative		
Laser-etch	—	—
Pad-print	✓	✓
Poles		
Single	✓	✓
Double	—	✓
Four	—	—
Termination		
Spade	✓	✓
Solder	✓	✓
Screw	✓	—
Weld lugs	—	—
Illumination		
Incandescent 6 Vdc	—	✓
Incandescent 12 Vdc	—	✓
Incandescent 14 Vdc	—	—
Incandescent 18 Vdc	—	—
Incandescent 24 Vdc	—	✓
Incandescent 28 Vdc	—	—
Neon 110V	—	—
Neon 125V	—	✓
Neon 250V	—	✓
14V LED	—	—
28V LED	—	—
Catalog Number Selection	Page V11-T2-42	Page V11-T2-44
Technical Data	—	Page V11-T2-46
Circuit Diagrams	—	Page V11-T2-78
Dimensions	Page V11-T2-42	Page V11-T2-46
Icon/Legend Symbols Library	—	Page V11-T2-53

See Technical Data and Dimensions for more details.

Rocker Switches—Illuminated and Non-Illuminated, continued

1600/2600

Rockette



Features

Ratings	Up to 22A at 125 Vac, 16A at 250 Vac	Up to 15A at 125 Vac, 10A at 250 Vac, 3/4 hp at 250 Vac
Certifications	UL, CSA, ENEC, RoHS	UL, CSA, RoHS
Panel Opening	Rectangular	Octagonal
Single- and two-pole length	1.075 in (27.30 ± 0.10 mm)	1.450 in (36.83 mm); 1.190 in (30.23 mm)
Single-pole width	0.483 in (12.27 ± 0.07 mm)	0.830 in (21.80 mm); 0.680 in (17.27 mm)
Two-pole width	0.876 in (22.25 ± 0.10 mm)	0.830 in (21.80 mm); 0.680 in (17.27 mm)
Seal		
Top (internal)	—	✓
Bottom (internal)	—	—
Panel	—	—
Actuator		
Rocker without bezel	—	—
Rocker with bezel	✓	✓
Paddle	✓	—
Snap-in lens	—	—
Locking	—	—
Label	—	—
Decorative		
Laser-etch	—	—
Pad-print	✓	✓
Poles		
Single	✓	—
Double	✓	✓
Four	—	✓
Termination		
Spade	✓	✓
Solder	✓	✓
Screw	—	✓
Weld lugs	—	—
Illumination		
Incandescent 6 Vdc	✓	—
Incandescent 12 Vdc	✓	—
Incandescent 14 Vdc	—	✓
Incandescent 18 Vdc	—	—
Incandescent 24 Vdc	✓	—
Incandescent 28 Vdc	—	✓
Neon 110V	—	✓
Neon 125V	—	—
Neon 250V	—	—
14V LED	—	—
28V LED	—	—
Catalog Number Selection	Page V11-T2-48	Page V11-T2-55
Technical Data	Page V11-T2-52	Page V11-T2-58
Circuit Diagrams	Page V11-T2-78	Page V11-T2-78
Dimensions	Page V11-T2-52	Page V11-T2-58
Icon/Legend Symbols Library	Page V11-T2-53	—

See Technical Data and Dimensions for more details.

Rocker Switches—Illuminated and Non-Illuminated, continued

2

8006/8007

8004/8005





Features

Ratings	10A at 250 Vac, 15A at 125 Vac, 3/4 hp at 250 Vac, recommended up to 15A at 28 Vdc	10A at 250 Vac, 15A at 125 Vac, 3/4 hp at 250 Vac, recommended up to 15A at 28 Vdc
Certifications	UL(CUR), RoHS	UL(CUR), RoHS
Panel Opening	Octagonal	Rectangular
Single- and two-pole length	1.450 in (36.85 mm); 1.190 in (30.23 mm)	1.734 in (44.04 ± 0.13 mm)
Single-pole width	0.830 in (21.08 mm); 0.680 in (17.27 mm)	0.867 in (22.02 ± 0.13 mm)
Two-pole width	0.830 in (21.08 mm); 0.680 in (17.27 mm)	0.867 in (22.02 ± 0.13 mm)
Seal		
Top (internal)	✓	✓
Bottom (internal)	—	—
Panel	—	—
Actuator		
Rocker without bezel	—	—
Rocker with bezel	✓	✓
Paddle	✓	—
Snap-in lens	✓	✓
Locking	—	—
Label	—	✓
Decorative		
Laser-etch	—	—
Pad-print	✓	✓
Poles		
Single	✓	✓
Double	✓	✓
Four	—	—
Termination		
Spade	✓	✓
Solder	✓	✓
Screw	✓	✓
Weld lugs	—	—
Illumination		
Incandescent 6 Vdc	—	—
Incandescent 12 Vdc	—	—
Incandescent 14 Vdc	✓	✓
Incandescent 18 Vdc	✓	✓
Incandescent 24 Vdc	—	—
Incandescent 28 Vdc	✓	✓
Neon 110V	—	—
Neon 125V	✓	✓
Neon 250V	✓	✓
14V LED	—	—
28V LED	—	—
Catalog Number Selection	Page V11-T2-63	Page V11-T2-66
Technical Data	Page V11-T2-64	Page V11-T2-67
Circuit Diagrams	Page V11-T2-78	Page V11-T2-78
Dimensions	Page V11-T2-64	Page V11-T2-67
Icon/Legend Symbols Library	—	—

See Technical Data and Dimensions for more details.

Rocker Switches—Illuminated and Non-Illuminated, continued

	X Series	8064/8065
		
Features		
Ratings	16A 125V, 10A 277V, 3/4 hp 277V Recommended 21A 14 Vdc or 10A 28 Vdc	10A at 250 Vac, 15A at 125 Vac, 3/4 hp at 250 Vac, recommended up to 15A at 28 Vdc
Certifications	UL(CUR); RoHS, T85	UL(CUR); RoHS
Panel Opening	Rectangular	Rectangular
Single- and two-pole length	1.46 in (37.00 ± 0.1 mm)	1.734 in (44.04 ± 0.13 mm)
Single-pole width	0.83 in (21.20 ± 0.1 mm)	0.867 in (22.02 ± 0.13 mm)
Two-pole width	0.83 in (21.20 ± 0.1 mm)	0.867 in (22.02 ± 0.13 mm)
Seal		
Top (internal)	✓	—
Bottom (internal)	—	—
Panel	—	—
Actuator		
Rocker without bezel	—	—
Rocker with bezel	✓	✓
Paddle	—	✓
Snap-in lens	—	—
Locking	—	—
Label	—	✓
Decorative		
Laser-etch	✓	—
Pad-print	—	✓
Poles		
Single	✓	✓
Double	✓	✓
Four	—	—
Termination		
Spade	✓	✓
Solder	✓	—
Screw	✓	—
Weld lugs	—	—
Illumination		
Incandescent 6 Vdc	—	—
Incandescent 12 Vdc	—	—
Incandescent 14 Vdc	—	—
Incandescent 18 Vdc	—	—
Incandescent 24 Vdc	—	—
Incandescent 28 Vdc	—	—
Neon 110V	—	—
Neon 125V	—	—
Neon 250V	—	—
14V LED	✓	✓
28V LED	✓	✓
125V LED	✓	—
277V LED	✓	—
Catalog Number Selection	Page V11-T2-69	Page V11-T2-73
Technical Data	Page V11-T2-70	Page V11-T2-74
Circuit Diagrams	Page V11-T2-70 (Light Diagrams)	Page V11-T2-78
Dimensions	Page V11-T2-71	Page V11-T2-75
Icon/Legend Symbols Library	Page V11-T2-70	Page V11-T2-74

NGR Rocker Switches

2



Product Description

Eaton presents its NGR Rocker Switches. This field-proven line of full-sized rocker switches, initially developed for the heavy truck industry, is now found in a variety of vehicle-related applications.

The NGR offers both European styling and ergonomic design while still providing the solid durability that you have come to expect from Eaton switches.

Illuminated and non-illuminated versions with either incandescent bulbs or LEDs are available in either dependent or independent circuits and in a variety of popular switching circuits.

The NGR also offers a variety of rocker buttons and indicators with laser-etched or pad-printed icons, insertable lenses and adhesive-backed labels.

Features

- Sealing
Standard switch provides splash and dust resistance to IP42. The sealed version is sealed to IP67 when supplied with panel seal.
- Rocker
The standard actuator for the NGR is a clean, European-styled, two-face rocker made of high-quality thermoplastic material. The rocker is replaceable and snaps on and off the switch. Both the rocker and the bezel are supplied with an aesthetically pleasing matte finish. Different colors are also available, but black is standard. Rockers can be ordered separately.

Contents

<i>Description</i>	<i>Page</i>
NGR Rocker Switches	
Switch Base	V11-T2-10
Rocker Buttons/Actuators	V11-T2-11
Lens Selection	V11-T2-13
NGR Complete Indicators and Indicator Caps	V11-T2-14
NGR Indicator Base and Indicator Caps	V11-T2-15
Technical Data and Specifications	V11-T2-16
Standard Circuit Diagrams	V11-T2-17
Dimensions	V11-T2-30

- Lighting
Each switch is capable of accommodating two incandescent light bulbs or LEDs for lighting purposes. A lamp or LED can be located at either end of the switch and oriented to be circuit dependent or independent. The incandescent bulbs are front replaceable. Two lamp or LED voltages, 14 Vdc and 28 Vdc, are standard. For additional voltages or colors, consult your local Eaton Sales Representative.

Standards and Certifications

- Approvable under stringent UL and CSA standards
- For information, contact your local Eaton Sales Representative
- RoHS Compliant ^①



Note

^① Visit www.eaton.com/vcbu for the most up-to-date list of verified part numbers.

Options

- Circuits
 - 1PST, 1PDT, 2PST and 2PDT
 - Maintained and momentary action
- Common lamp ground jumper for dual lamp units
- Multiple LEDs for daylight readability
- Additional colors of rockers, mounting bezels and lenses are available
- Special circuits
- Special ratings
- Pad-printed legends on lens, rocker and bezel
- Special lamps and lamp voltages
- Dry circuit capabilities
- Custom back-lit legends available
- Reversing jumpers (internal)

- Gang mounting system, see **Page V11-T2-77**
- Locking rocker with locking feature in UP and/or DOWN positions
- Indicators with laser-etched or insertable lenses, or adhesive labels
- IP67 rated sealed switch
- Polarized lock-on connectors, see **Page V11-T2-76**
 - 28-5637-2 for Packard terminals
 - 28-5940 for AMP terminals
- Panel plug 17-21543
- Replacement bulb catalog number
 - 14V: 28-5901
 - 28V: 28-5909

For more information on additional options, contact your local Eaton Sales Representative.

Legends

Two legend areas are provided on the ends of each rocker of sufficient size to accommodate two lines consisting of four Helvetica Narrow 12-point characters. Legends may be non-illuminated or illuminated. The NGR offers three styles of illuminated legends.

Single-piece back-lit—Back-lighting is a high-quality automotive/truck industry technique. The legend can appear daylight white or dead-front when non-illuminated but, depending on the back-lit color chosen, will change color when illuminated. Examples of standard back-lit legends are found on **Pages V11-T2-80 to V11-T2-94**.

Snap-in lenses—This rocker will have either one or two snap-in lenses in the legend areas. Legends are typically pad-printed on the lens in black or white. Snap-in lenses are available in six standard colors and can be ordered separately.

Label rocker—This rocker has a one-piece adhesive-backed label inserted into a recessed area on the face of the button. Legends can be done in several colors and be illuminated or non-illuminated. Contact your local Eaton Sales Representative for suggested sources.

Flexible Ordering System

You can order assembled switches or the switch base and actuator separately.

Use the final code in the switch base catalog number, **Page V11-T2-10**, to denote assembly instructions.



To order rocker and switch base assembled, contact your local Eaton Sales Representative.

To order rocker buttons, see **Page V11-T2-11**.

To order lenses, see **Page V11-T2-13**.

To order indicator caps, see **Page V11-T2-15**. For a complete indicator, see **Page V11-T2-14**.

Catalog Number Selection

How To Order—Switch Base

To determine complete catalog number, start with the appropriate base prefix and add the appropriate code letters and/or numbers.

Example: NGR 1501 4 B N A 0 N

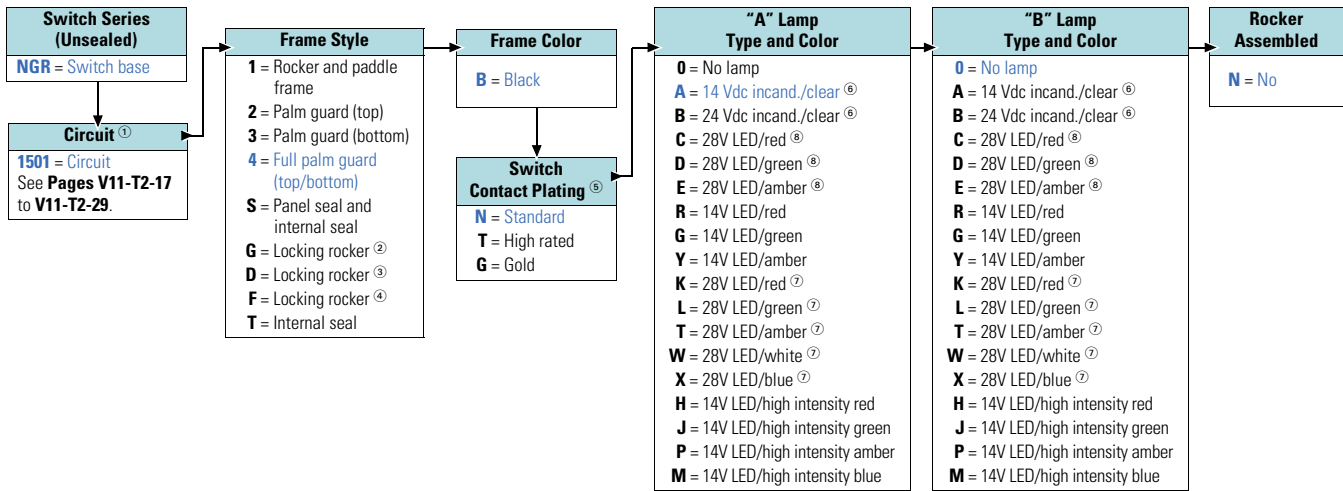

Notes

- ① Circuits show lighting options available. See **Pages V11-T2-17 to V11-T2-29**.
- ② Locks in DOWN position.
- ③ Locks in UP and DOWN positions.
- ④ Locks in UP position.
- ⑤ Switch contact construction plating—
 N = Standard: Recommended for use on loads up to 12 amps at 14 Vdc.
 T = High Rated: Recommended for use on loads greater than 12 amps at 14 Vdc.
 G = Gold: Recommended for use on dry circuit/low level switching.
- ⑥ Replaceable.
- ⑦ Replaceable/wedge base LED.
- ⑧ PCB version LED.

Rocker Buttons/Actuators



Catalog Number Selection

How To Order—Rocker Buttons/Actuators

To determine complete catalog number, start with the appropriate button type and add the appropriate code letters and/or numbers.

Example: **3 C A F A 1 B A E C 4 A 3**

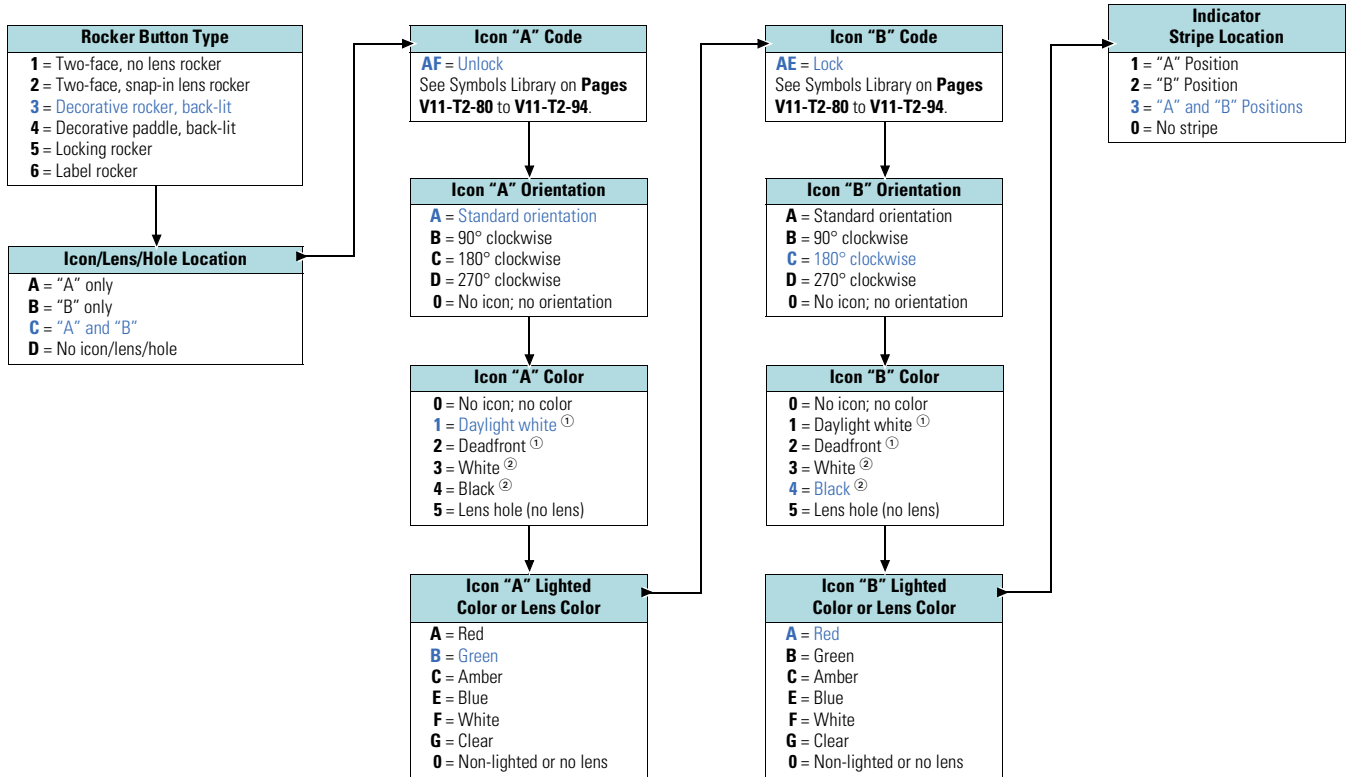

Notes
 ① Decorative rocker only.
 ② Two-face rocker only.

Icon Location Examples

Location A

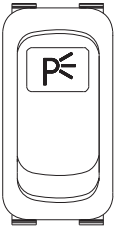

Rocker with Icon in "A" Position (Code A)

Location C

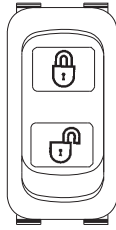

Rocker with Icon in "C" Position (Code C)

Location B

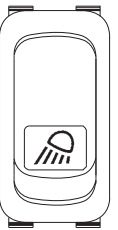

Rocker with Icon in "B" Position (Code B)

Icon Orientation Examples

Orientation A

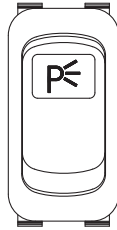

Rocker with Standard Orientation (Code A)

Orientation C

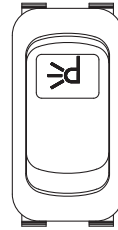

Rocker with Icon at 180° Clockwise (Code C)

Orientation B

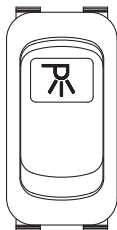

Rocker with Icon at 90° Clockwise (Code B)

Orientation D

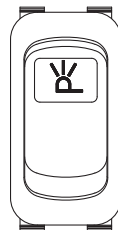

Rocker with Icon at 270° Clockwise (Code D)



Lens Selection

For NGR Rocker Type “2” and Indicator Type “2CAP” only.

Catalog Number Selection

How To Order—Translucent Lenses ①②

To determine complete catalog number, start with the appropriate base prefix and add the appropriate code letters and/or numbers.

Example: **28-5863-2 AF A**

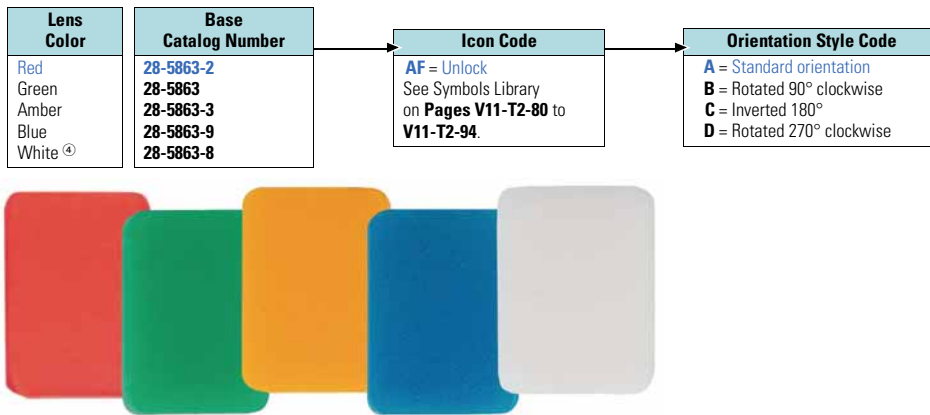

How To Order—Transparent Lenses ①②

To determine complete catalog number, start with the appropriate base prefix and add the appropriate code letters and/or numbers.

Example: **28-5863-5 AF A**

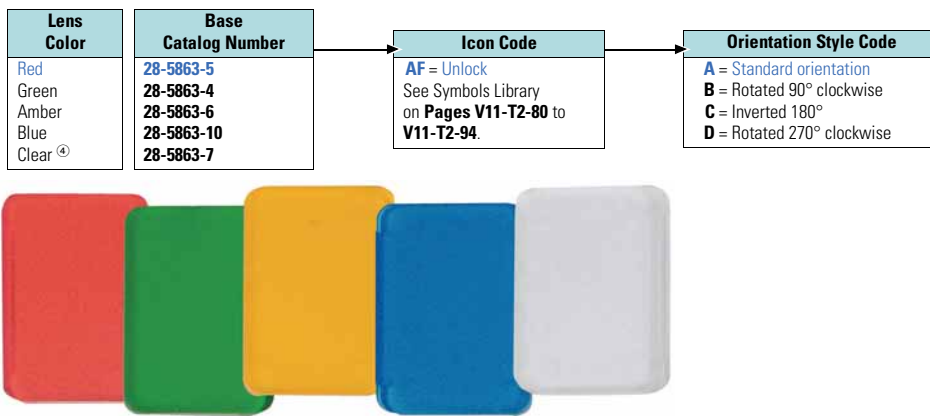

Notes

- ① When ordering a lens with an icon for the code **B** (bottom) position, specify code **C** orientation.
- ② Standard lens type.
- ③ Non-standard lens type.
- ④ Standard pad print for white and clear lens is black.

Complete Indicator and Indicator Cap Assembled

2



NGR Complete Indicators and Indicator Caps

To order rocker buttons, see **Page V11-T2-11**.

To order lenses, see **Page V11-T2-13**.

Catalog Number Selection

How To Order—Complete Indicator

To determine complete catalog number, start with the appropriate indicator type and add the appropriate code letters and/or numbers.

Example: **2N C AA R 1 B AB A 0 A**

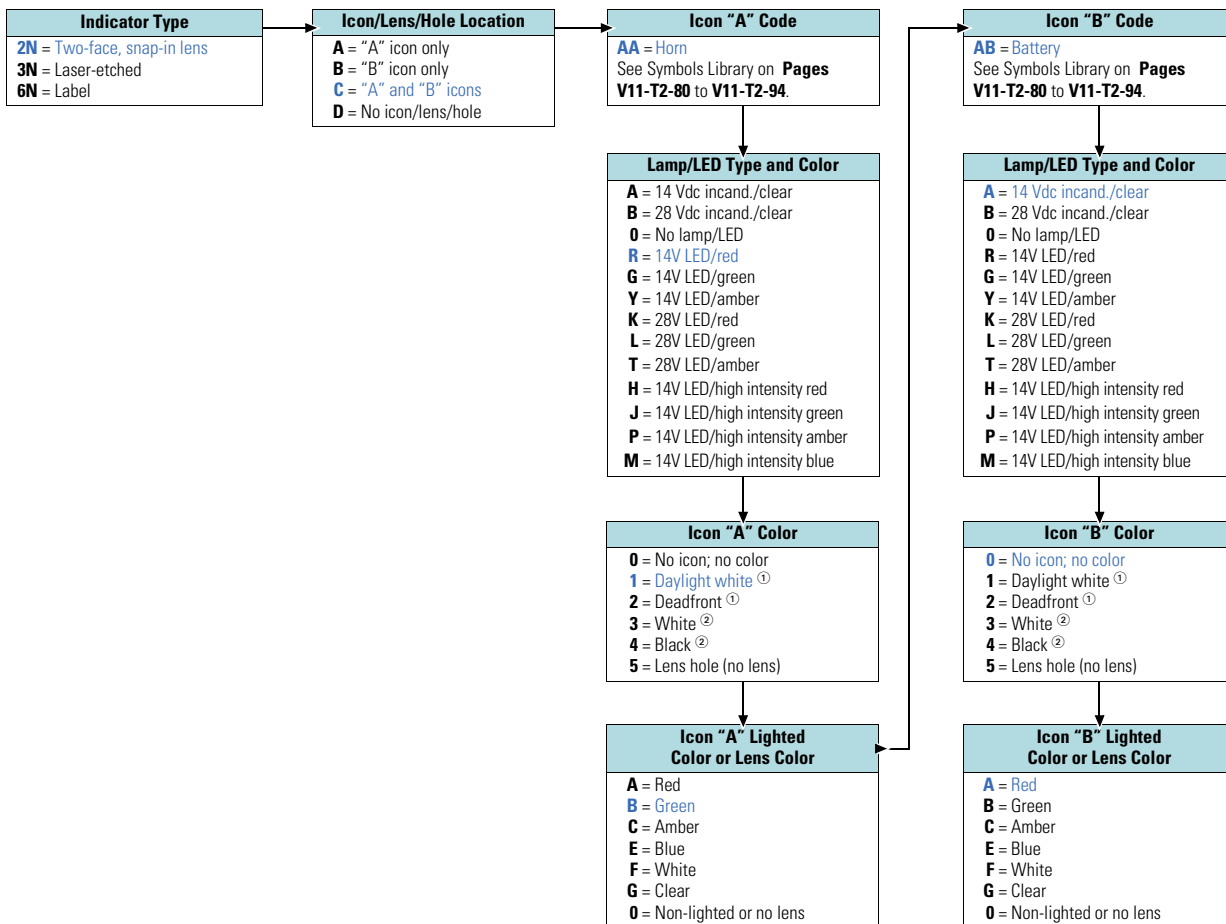

Notes

^① Decorative rocker only.

^② Two-face rocker only.



NGR Indicator Base and Indicator Caps

To order rocker buttons, see **Page V11-T2-11**.
 To order lenses, see **Page V11-T2-13**.
 To order complete indicator, see **Page V11-T2-14**.

Catalog Number Selection

How To Order—Indicator Base

To determine complete catalog number, start with the appropriate base prefix and add the appropriate code letters and/or numbers.

Example: NGRIND A 0 N

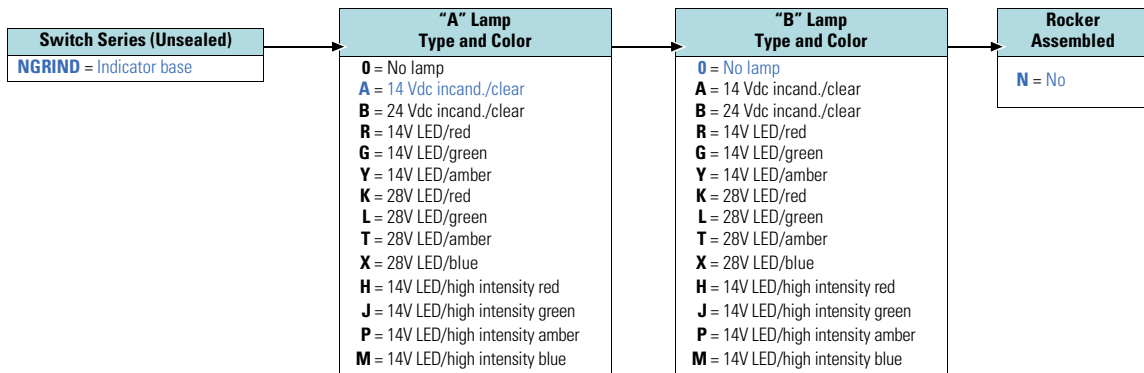

How To Order—Indicator Cap

To determine complete catalog number, start with the appropriate indicator type and add the appropriate code letters and/or numbers.

Example: 2CAP C AB 1 B AH 0 A

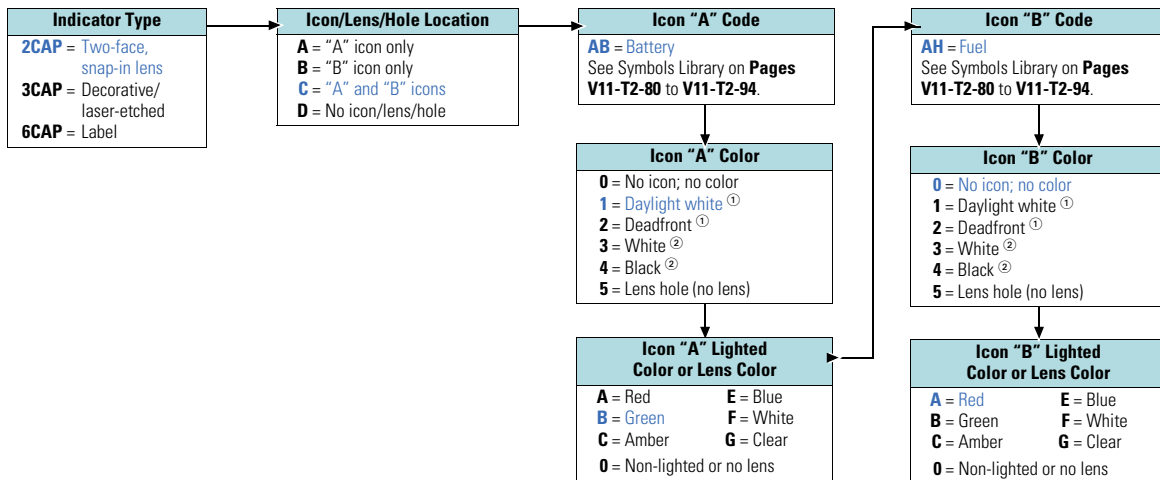

Notes

- ① Decorative rocker only.
- ② Two-face rocker only.

Technical Data and Specifications

2

NGR Rocker Switches

Description	Specification
Ratings ^①	15A at 125 Vac, 10A at 250 Vac 15A at 28 Vdc (14 Vdc rating) Approvable under stringent UL and CSA standards
Contact mechanism	Slow-make/slow-break contact mechanism Butt action contact mechanism designed specifically for use on AC and low voltage DC applications
Contact material— Standard construction	Movable—copper alloy with silver alloy contact face button Stationary—silver-plated copper alloy with silver alloy contact face button
Mechanical life	250,000 operations, minimum
Electrical life	200,000 operations, minimum
Terminal type	Standard 0.25 in (6.35 mm) spade, silver-plated copper alloy
Base material	High-grade thermoplastic molding material
Dielectric	1000V rms, minimum
Mounting means	Snap-in mounting with plastic bezel
Mounting hole	Rectangular panel cutout 1.734 x 0.867 in (44 x 22 mm)
Panel thickness	0.040 to 0.156 in (1.0 to 4.0 mm) ^{② ③}
IP rating	Standard IP42; sealed option IP67
Operating temperature range	–40° to 185°F (–40° to 85°C)

Notes

- ① For information, contact your local Eaton Sales Representative.
- ② Best results obtained between 0.060 and 0.118 in (1.5 and 3.0 mm).
- ③ On sealed versions, recommended panel thickness between 0.079 and 0.118 in (2.0 and 3.0 mm).

Standard Circuit Diagrams

Single-Pole

Circuit No.	Schematic (Shown in UP Position)	Circuit with Rocker In ...		
		DOWN Position	CENTER Position	UP Position
1001		OFF	NONE	ON 2B-3
1501		OFF	NONE	ON 2B-3-9
1502		OFF	NONE	ON 2B-3-10
1503		OFF	NONE	ON 2B-3
1504		OFF	NONE	ON 2B-3
1505		OFF	NONE	ON 2B-3-9
1506		OFF	NONE	ON 2B-3-10
1507		OFF	NONE	ON 2B-3-9-10
1508		OFF	NONE	ON 2B-3

Two-Pole

Circuit No.	Schematic (Shown in UP Position)	Circuit with Rocker In ...		
		DOWN Position	CENTER Position	UP Position
2001		OFF	NONE	ON 2B-3 5B-6
2501		OFF	NONE	ON 2B-3-9 5B-6
2502		OFF	NONE	ON 2B-3-10 5B-6
2503		OFF	NONE	ON 2B-3 5B-6
2504		OFF	NONE	ON 2B-3 5B-6
2505		OFF	NONE	ON 2B-3-9 5B-6
2506		OFF	NONE	ON 2B-3-10 5B-6
2507		OFF	NONE	ON 2B-3-9-1 5B-6
2508		OFF	NONE	ON 2B-3 5B-6

2.2

Rockers

NGR Rocker Switches

Single-Pole

2

Circuit No.	Schematic (Shown in UP Position)	Circuit with Rocker In ...		
		DOWN Position	CENTER Position	UP Position
1002		OFF	NONE	MOM. ON 2B-3
1521		OFF	NONE	MOM. ON 2B-3-9
1522		OFF	NONE	MOM. ON 2B-3-10
1523		OFF	NONE	MOM. ON 2B-3
1524		OFF	NONE	MOM. ON 2B-3
1525		OFF	NONE	MOM. ON 2B-3-9
1526		OFF	NONE	MOM. ON 2B-3-10
1528		OFF	NONE	MOM. ON 2B-3

Two-Pole

Circuit No.	Schematic (Shown in UP Position)	Circuit with Rocker In ...		
		DOWN Position	CENTER Position	UP Position
2002		OFF	NONE	MOM. ON 2B-3 5B-6
2521		OFF	NONE	MOM. ON 2B-3-9 5B-6
2522		OFF	NONE	MOM. ON 2B-3-10 5B-6
2523		OFF	NONE	MOM. ON 2B-3 5B-6
2524		OFF	NONE	MOM. ON 2B-3 5B-6
2525		OFF	NONE	MOM. ON 2B-3-9 5B-6
2526		OFF	NONE	MOM. ON 2B-3-10 5B-6
2528		OFF	NONE	MOM. ON 2B-3 5B-6

Single-Pole

Circuit No.	Schematic (Shown in UP Position)	Circuit with Rocker In ...		
		DOWN Position	CENTER Position	UP Position
1003		ON	NONE	ON
		2B-1	—	2B-3
1541		ON	NONE	ON
		2B-1	—	2B-3-9
1542		ON	NONE	ON
		2B-1	—	2B-3-10
1543		ON	NONE	ON
		2B-1	—	2B-3
1544		ON	NONE	ON
		2B-1	—	2B-3
1545		ON	NONE	ON
		2B-1	—	2B-3-9
1546		ON	NONE	ON
		2B-1	—	2B-3-10
1547		ON	NONE	ON
		2B-1-10	—	2B-3-9
1548		ON	NONE	ON
		2B-1	—	2B-3

Two-Pole

Circuit No.	Schematic (Shown in UP Position)	Circuit with Rocker In ...		
		DOWN Position	CENTER Position	UP Position
2003		ON	NONE	ON
		2B-1	—	2B-3 5B-6
2541		ON	NONE	ON
		2B-1	—	2B-3-9 5B-6
2542		ON	NONE	ON
		2B-1	—	2B-3-10 5B-6
2543		ON	NONE	ON
		2B-1	—	2B-3 5B-6
2544		ON	NONE	ON
		2B-1	—	2B-3 5B-6
2545		ON	NONE	ON
		2B-1	—	2B-3-9 5B-6
2546		ON	NONE	ON
		2B-1	—	2B-3-10 5B-6
2547		ON	NONE	ON
		2B-1-10	—	2B-3-9 5B-6
2548		ON	NONE	ON
		2B-1	—	2B-3 5B-6

2.2

Rockers

NGR Rocker Switches

Single-Pole

2

Circuit No.	Schematic (Shown in UP Position)	Circuit with Rocker In ...		
		DOWN Position	CENTER Position	UP Position
1004		ON	OFF	ON
		2B-1	—	2B-3
1561		ON	OFF	ON
		2B-1	—	2B-3-9
1562		ON	OFF	ON
		2B-1	—	2B-3-10
1563		ON	OFF	ON
		2B-1	—	2B-3
1564		ON	OFF	ON
		2B-1	—	2B-3
1565		ON	OFF	ON
		2B-1	—	2B-3-9
1566		ON	OFF	ON
		2B-1	—	2B-3-10
1567		ON	OFF	ON
		2B-1-10	—	2B-3-9
1568		ON	OFF	ON
		2B-1	—	2B-3

Two-Pole

Circuit No.	Schematic (Shown in UP Position)	Circuit with Rocker In ...		
		DOWN Position	CENTER Position	UP Position
2004		ON	OFF	ON
		2B-1	—	2B-3
		5B-4	—	5B-6
2561		ON	OFF	ON
		2B-1	—	2B-3-9
		5B-4	—	5B-6
2562		ON	OFF	ON
		2B-1	—	2B-3-10
		5B-4	—	5B-6
2563		ON	OFF	ON
		2B-1	—	2B-3
		5B-4	—	5B-6
2564		ON	OFF	ON
		2B-1	—	2B-3
		5B-4	—	5B-6
2565		ON	OFF	ON
		2B-1	—	2B-3-9
		5B-4	—	5B-6
2566		ON	OFF	ON
		2B-1	—	2B-3-10
		5B-4	—	5B-6
2567		ON	OFF	ON
		2B-1-10	—	2B-3-9
		5B-4	—	5B-6
2568		ON	OFF	ON
		2B-1	—	2B-3
		5B-4	—	5B-6

Single-Pole

Circuit No.	Schematic (Shown in UP Position)	Circuit with Rocker In ...		
		DOWN Position	CENTER Position	UP Position
1005		MOM. ON	OFF	MOM. ON
		2B-1	—	2B-3
1581		MOM. ON	OFF	MOM. ON
		2B-1	—	2B-3-9
1582		MOM. ON	OFF	MOM. ON
		2B-1	—	2B-3-10
1583		MOM. ON	OFF	MOM. ON
		2B-1	—	2B-3
1584		MOM. ON	OFF	MOM. ON
		2B-1	—	2B-3
1585		MOM. ON	OFF	MOM. ON
		2B-1	—	2B-3-9
1586		MOM. ON	OFF	MOM. ON
		2B-1	—	2B-3-10
1587		MOM. ON	OFF	MOM. ON
		2B-1-10	—	2B-3-9
1588		MOM. ON	OFF	MOM. ON
		2B-1	—	2B-3

Two-Pole

Circuit No.	Schematic (Shown in UP Position)	Circuit with Rocker In ...		
		DOWN Position	CENTER Position	UP Position
2005		MOM. ON	OFF	MOM. ON
		2B-1	—	2B-3
		5B-4	—	5B-6
2581		MOM. ON	OFF	MOM. ON
		2B-1	—	2B-3-9
		5B-4	—	5B-6
2582		MOM. ON	OFF	MOM. ON
		2B-1	—	2B-3-10
		5B-4	—	5B-6
2583		MOM. ON	OFF	MOM. ON
		2B-1	—	2B-3
		5B-4	—	5B-6
2584		MOM. ON	OFF	MOM. ON
		2B-1	—	2B-3
		5B-4	—	5B-6
2585		MOM. ON	OFF	MOM. ON
		2B-1	—	2B-3-9
		5B-4	—	5B-6
2586		MOM. ON	OFF	MOM. ON
		2B-1	—	2B-3-10
		5B-4	—	5B-6
2587		MOM. ON	OFF	MOM. ON
		2B-1-10	—	2B-3-9
		5B-4	—	5B-6
2588		MOM. ON	OFF	MOM. ON
		2B-1	—	2B-3
		5B-4	—	5B-6

2.2

Rockers

NGR Rocker Switches

Single-Pole

2

Circuit No.	Schematic (Shown in UP Position)	Circuit with Rocker In ...		
		DOWN Position	CENTER Position	UP Position
1006		ON	OFF	MOM. ON
		2B-1	—	2B-3
1601		ON	OFF	MOM. ON
		2B-1	—	2B-3-9
1602		ON	OFF	MOM. ON
		2B-1	—	2B-3-10
1603		ON	OFF	MOM. ON
		2B-1	—	2B-3
1604		ON	OFF	MOM. ON
		2B-1	—	2B-3
1605		ON	OFF	MOM. ON
		2B-1	—	2B-3-9
1606		ON	OFF	MOM. ON
		2B-1	—	2B-3-10
1607		ON	OFF	MOM. ON
		2B-1-10	—	2B-3-9
1608		ON	OFF	MOM. ON
		2B-1	—	2B-3

Two-Pole

Circuit No.	Schematic (Shown in UP Position)	Circuit with Rocker In ...		
		DOWN Position	CENTER Position	UP Position
2006		ON	OFF	MOM. ON
		2B-1	—	2B-3
		5B-4	—	5B-6
2601		ON	OFF	MOM. ON
		2B-1	—	2B-3-9
		5B-4	—	5B-6
2602		ON	OFF	MOM. ON
		2B-1	—	2B-3-10
		5B-4	—	5B-6
2603		ON	OFF	MOM. ON
		2B-1	—	2B-3
		5B-4	—	5B-6
2604		ON	OFF	MOM. ON
		2B-1	—	2B-3
		5B-4	—	5B-6
2605		ON	OFF	MOM. ON
		2B-1	—	2B-3-9
		5B-4	—	5B-6
2606		ON	OFF	MOM. ON
		2B-1	—	2B-3-10
		5B-4	—	5B-6
2607		ON	OFF	MOM. ON
		2B-1-10	—	2B-3-9
		5B-4	—	5B-6
2608		ON	OFF	MOM. ON
		2B-1	—	2B-3
		5B-4	—	5B-6

Single-Pole

Circuit No.	Schematic (Shown in UP Position)	Circuit with Rocker In ...		
		DOWN Position	CENTER Position	UP Position
1007		ON	NONE	MOM ON
		2B-1	—	2B-3
1621		ON	NONE	MOM ON
		2B-1	—	2B-3-9
1622		ON	NONE	MOM ON
		2B-1	—	2B-3-10
1623		ON	NONE	MOM ON
		2B-1	—	2B-3
1624		ON	NONE	MOM ON
		2B-1	—	2B-3
1625		ON	NONE	MOM ON
		2B-1	—	2B-3-9
1626		ON	NONE	MOM ON
		2B-1	—	2B-3-10
1627		ON	NONE	MOM ON
		2B-1-10	—	2B-3-9
1628		ON	NONE	MOM ON
		2B-1	—	2B-3

Two-Pole

Circuit No.	Schematic (Shown in UP Position)	Circuit with Rocker In ...		
		DOWN Position	CENTER Position	UP Position
2007		ON	NONE	MOM ON
		2B-1	—	2B-3 5B-6
2621		ON	NONE	MOM ON
		2B-1	—	2B-3-9 5B-6
2622		ON	NONE	MOM ON
		2B-1	—	2B-3-10 5B-6
2623		ON	NONE	MOM ON
		2B-1	—	2B-3 5B-6
2624		ON	NONE	MOM ON
		2B-1	—	2B-3 5B-6
2625		ON	NONE	MOM ON
		2B-1	—	2B-3-9 5B-6
2626		ON	NONE	MOM ON
		2B-1	—	2B-3-10 5B-6
2627		ON	NONE	MOM ON
		2B-1-10	—	2B-3-9 5B-6
2628		ON	NONE	MOM ON
		2B-1	—	2B-3 5B-6

Single-Pole

2

Circuit No.	Schematic (Shown in UP Position)	Circuit with Rocker In ...		
		DOWN Position	CENTER Position	UP Position
3003		OFF	ON	ON
3541		OFF	ON	ON
3542		OFF	ON	ON
3543		OFF	ON	ON
3544		OFF	ON	ON
3545		OFF	ON	ON
3546		OFF	ON	ON
3547		OFF	ON	ON
3548		OFF	ON	ON

Two-Pole

Circuit No.	Schematic (Shown in UP Position)	Circuit with Rocker In ...		
		DOWN Position	CENTER Position	UP Position
3004		OFF	ON	ON
3561		OFF	ON	ON
3562		OFF	ON	ON
3563		OFF	ON	ON
3564		OFF	ON	ON
3565		OFF	ON	ON
3566		OFF	ON	ON
3567		OFF	ON	ON
3568		OFF	ON	ON

Single-Pole

Circuit No.	Schematic (Shown in UP Position)	Circuit with Rocker In ...		
		DOWN Position	CENTER Position	UP Position
5001		ON	NONE	OFF
5501		ON	NONE	OFF
5502		ON	NONE	OFF
5503		ON	NONE	OFF
5504		ON	NONE	OFF
5505		ON	NONE	OFF
5506		ON	NONE	OFF
5507		ON	NONE	OFF
5508		ON	NONE	OFF

Two-Pole

Circuit No.	Schematic (Shown in UP Position)	Circuit with Rocker In ...		
		DOWN Position	CENTER Position	UP Position
5510		ON	NONE	OFF
5511		ON	NONE	OFF
5512		ON	NONE	OFF
5513		ON	NONE	OFF
5514		ON	NONE	OFF
5515		ON	NONE	OFF
5516		ON	NONE	OFF
5517		ON	NONE	OFF
5518		ON	NONE	OFF

2.2

Rockers

NGR Rocker Switches

Single-Pole

2

Circuit No.	Schematic (Shown in UP Position)	Circuit with Rocker In ...		
		DOWN Position	CENTER Position	UP Position
5002		MOM. ON	NONE	OFF
		2B-1	—	—
5521		MOM. ON	NONE	OFF
		2B-1-9	—	—
5522		MOM. ON	NONE	OFF
		2B-1-10	—	—
5523		MOM. ON	NONE	OFF
		2B-1	—	—
5524		MOM. ON	NONE	OFF
		2B-1	—	—
5525		MOM. ON	NONE	OFF
		2B-1-9	—	—
5526		MOM. ON	NONE	OFF
		2B-1-10	—	—
5528		MOM. ON	NONE	OFF
		2B-1	—	—

Circuit No.	Schematic (Shown in UP Position)	Circuit with Rocker In ...		
		DOWN Position	CENTER Position	UP Position
5003		ON	ON	OFF
		2A-1	2A-2B	2B-3
5541		ON	ON	OFF
		2A-1	2A-2B	2B-3-9
5542		ON	ON	OFF
		2A-1	2A-2B	2B-3-10
5543		ON	ON	OFF
		2A-1	2A-2B	2B-3
5544		ON	ON	OFF
		2A-1	2A-2B	2B-3
5545		ON	ON	OFF
		2A-1	2A-2B	2B-3-9
5546		ON	ON	OFF
		2A-1	2A-2B	2B-3-10
5547		ON	ON	OFF
		2A-1-10	2A-2B	2B-3-9
5548		ON	ON	OFF
		2A-1	2A-2B	2B-3

Two-Pole

Circuit No.	Schematic (Shown in UP Position)	Circuit with Rocker In ...		
		DOWN Position	CENTER Position	UP Position
3001		ON	ON	ON
		5B-4-2B-1	5B-4-2B-3	2B-3 5B-6
3501		ON	ON	ON
		5B-4-2B-1	5B-4-2B-3-9	2B-3-9 5B-6
3502		ON	ON	ON
		5B-4-2B-1	5B-4-2B-3-10	2B-3-10 5B-6
3503		ON	ON	ON
		5B-4-2B-1	5B-4-2B-3	2B-3 5B-6
3504		ON	ON	ON
		5B-4-2B-1	5B-4-2B-3	2B-3 5B-6
3505		ON	ON	ON
		5B-4-2B-1	5B-4-2B-3	2B-3 5B-6
3506		ON	ON	ON
		5B-4-2B-1	5B-4-2B-3	2B-3 5B-6
3507		ON	ON	ON
		5B-4-2B-1	5B-4-2B-3-9	2B-3-9 5B-6
3508		ON	ON	ON
		5B-4-2B-1	5B-4-2B-3	2B-3 5B-6

Circuit No.	Schematic (Shown in UP Position)	Circuit with Rocker In ...		
		DOWN Position	CENTER Position	UP Position
3002		OFF	1-ON	2-ON
		2B-1 5B-4	2B-3 5B-4	2B-3 5B-6
3521		OFF	1-ON	2-ON
		2B-1 5B-4	2B-3-9 5B-4	2B-3-9 5B-6
3522		OFF	1-ON	2-ON
		2B-1 5B-4	2B-3-10 5B-4	2B-3-10 5B-6
3523		OFF	1-ON	2-ON
		2B-1 5B-4	2B-3 5B-4	2B-3 5B-6
3524		OFF	1-ON	2-ON
		2B-1 5B-4	2B-3 5B-4	2B-3 5B-6
3525		OFF	1-ON	2-ON
		2B-1 5B-4	2B-3-9 5B-4	2B-3-9 5B-6
3526		OFF	1-ON	2-ON
		2B-1 5B-4	2B-3-10 5B-4	2B-3-10 5B-6
3527		OFF	1-ON	2-ON
		2B-1-10 5B-4	2B-3-9 5B-4	2B-3-9 5B-6
3528		OFF	1-ON	2-ON
		2B-1 5B-4	2B-3 5B-4	2B-3 5B-6

2.2

Rockers

NGR Rocker Switches

Two-Pole

2

Circuit No.	Schematic (Shown in UP Position)	Circuit with Rocker In ...		
		DOWN Position	CENTER Position	UP Position
3005		MOM. ON	ON	MOM. ON
		2B-1 5B-4	2B-1 5B-6	2B-3 5B-6
3581		MOM. ON	ON	MOM. ON
		2B-1 5B-4	2B-1 5B-6	2B-3-9 5B-6
3582		MOM. ON	ON	MOM. ON
		2B-1 5B-4	2B-1 5B-6	2B-3-10 5B-6
3583		MOM. ON	ON	MOM. ON
		2B-1 5B-4	2B-1 5B-6	2B-3 5B-6
3584		MOM. ON	ON	MOM. ON
		2B-1 5B-4	2B-1 5B-6	2B-3 5B-6
3585		MOM. ON	ON	MOM. ON
		2B-1 5B-4	2B-1 5B-6	2B-3-9 5B-6
3586		MOM. ON	ON	MOM. ON
		2B-1 5B-4	2B-1 5B-6	2B-3-10 5B-6
3587		MOM. ON	ON	MOM. ON
		2B-1-10 5B-4	2B-1-10 5B-6	2B-3-9 5B-6
3588		MOM. ON	ON	MOM. ON
		2B-1 5B-4	2B-1 5B-6	2B-3 5B-6

Circuit No.	Schematic (Shown in UP Position)	Circuit with Rocker In ...		
		DOWN Position	CENTER Position	UP Position
4001		NONE	ON	MOM. ON
		2B-1 5B-4	2B-1 5B-4	2B-3 5B-6
4501		NONE	ON	MOM. ON
		2B-1 5B-4	2B-1 5B-4	2B-3-9 5B-6
4502		NONE	ON	MOM. ON
		2B-1 5B-4	2B-1 5B-4	2B-3-10 5B-6
4503		NONE	ON	MOM. ON
		2B-1 5B-4	2B-1 5B-4	2B-3 5B-6
4504		NONE	ON	MOM. ON
		2B-1 5B-4	2B-1 5B-4	2B-3 5B-6
4505		NONE	ON	MOM. ON
		2B-1 5B-4	2B-1 5B-4	2B-3-9 5B-6
4506		NONE	ON	MOM. ON
		2B-1 5B-4	2B-1 5B-4	2B-3-10 5B-6
4507		NONE	ON	MOM. ON
		2B-1-10 5B-4	2B-1-10 5B-4	2B-3-9 5B-6
4508		NONE	ON	MOM. ON
		2B-1 5B-4	2B-1 5B-4	2B-3 5B-6

Two-Pole

Circuit No.	Schematic (Shown in UP Position)	Circuit with Rocker In ...			Circuit No.	Schematic (Shown in UP Position)	Circuit with Rocker In ...		
		DOWN Position	CENTER Position	UP Position			DOWN Position	CENTER Position	UP Position
5004		ON	ON	OFF	5005		2-ON	1-ON	OFF
		2A-1 5A-4	2A-2B 5A-5B	2B-3 5B-6			2B-1 5B-4	2B-3 5B-4	2B-3 5B-6
5561		ON	ON	OFF	5581		2-ON	1-ON	OFF
		2A-1 5A-4	2A-2B 5A-5B	2B-3-9 5B-6			2B-1 5B-4	2B-3-9 5B-4	2B-3-9 5B-6
5562		ON	ON	OFF	5582		2-ON	1-ON	OFF
		2A-1 5A-4	2A-2B 5A-5B	2B-3-10 5B-6			2B-1 5B-4	2B-3-10 5B-4	2B-3-10 5B-6
5563		ON	ON	OFF	5583		2-ON	1-ON	OFF
		2A-1 5A-4	2A-2B 5A-5B	2B-3 5B-6			2B-1 5B-4	2B-3 5B-4	2B-3 5B-6
5564		ON	ON	OFF	5584		2-ON	1-ON	OFF
		2A-1 5A-4	2A-2B 5A-5B	2B-3 5B-6			2B-1 5B-4	2B-3 5B-4	2B-3 5B-6
5565		ON	ON	OFF	5585		2-ON	1-ON	OFF
		2A-1 5A-4	2A-2B 5A-5B	2B-3-9 5B-6			2B-1 5B-4	2B-3-9 5B-4	2B-3-9 5B-6
5566		ON	ON	OFF	5586		2-ON	1-ON	OFF
		2A-1 5A-4	2A-2B 5A-5B	2B-3-10 5B-6			2B-1 5B-4	2B-3-10 5B-4	2B-3-10 5B-6
5567		ON	ON	OFF	5587		2-ON	1-ON	OFF
		2A-1-10 5A-4	2A-2B 5A-5B	2B-3-9 5B-6			2B-1-10 5B-4	2B-3-9 5B-4	2B-3-9 5B-6
5568		ON	ON	OFF	5588		2-ON	1-ON	OFF
		2A-1 5A-4	2A-2B 5A-5B	2B-3 5B-6			2B-1 5B-4	2B-3 5B-4	2B-3-9 5B-6
					6001		ON	NONE	ON
							2A-2B-5A-5B- 10-1-4-3	—	3-6-1

Dimensions

Approximate Dimensions in Inches (mm)

2

Switch Base with Rocker Button

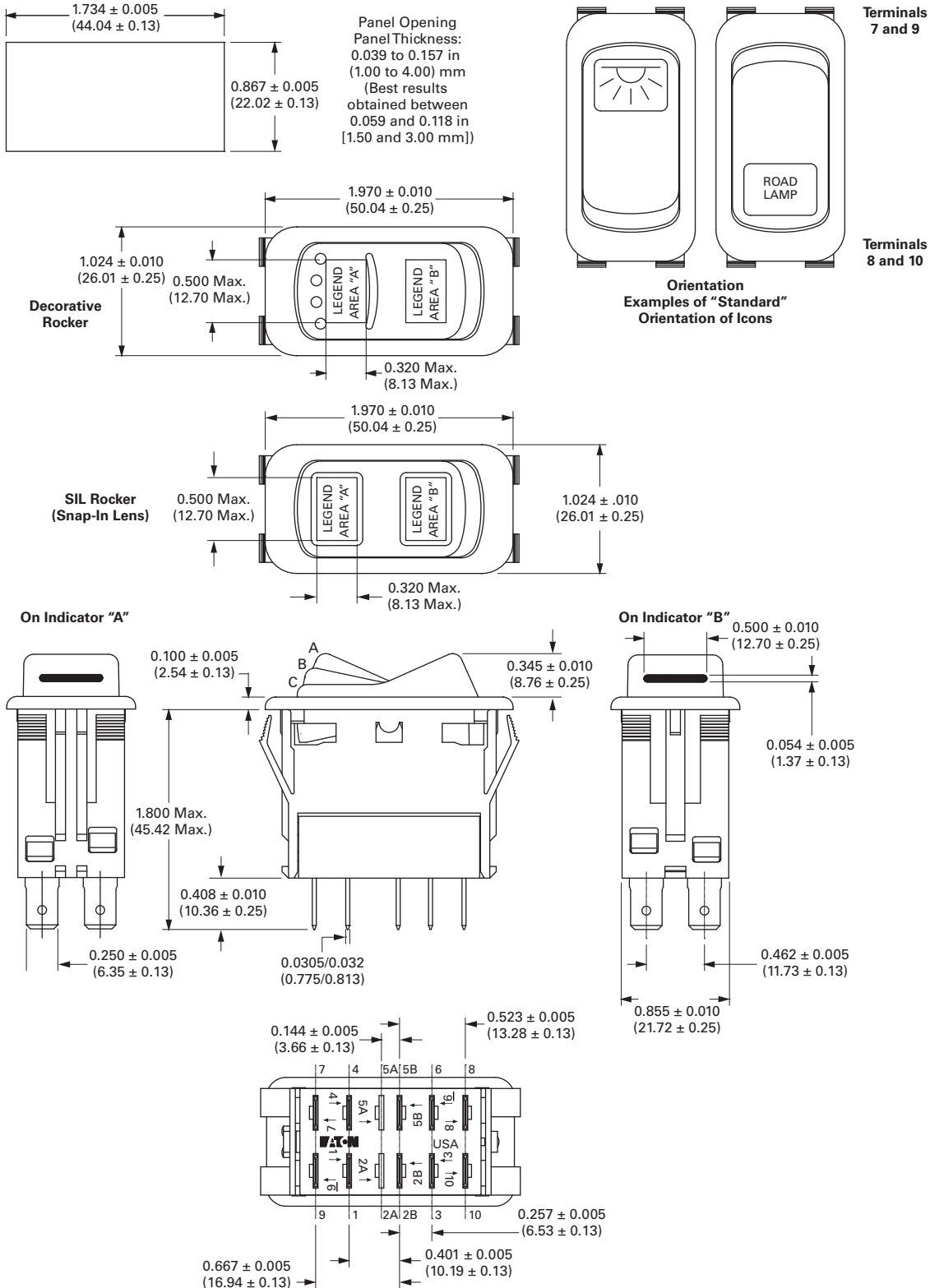

Approximate Dimensions in Inches (mm)

Locking Rocker

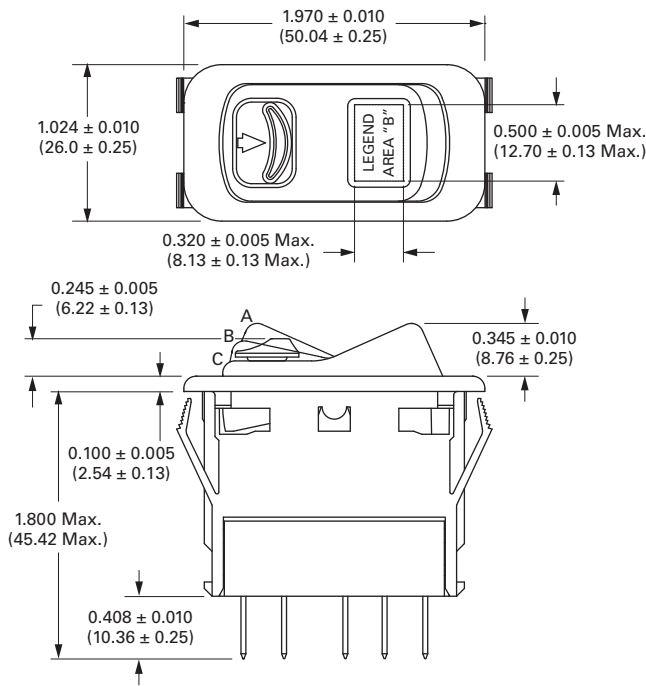

Sealed Rocker

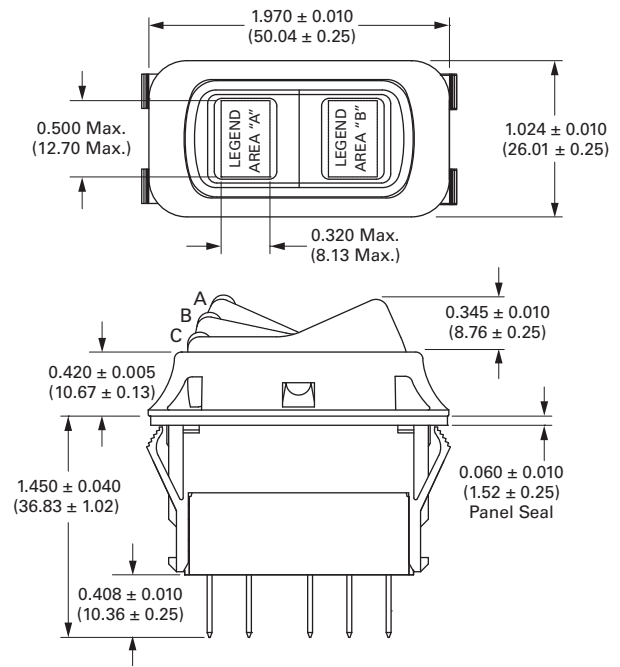

Indicator

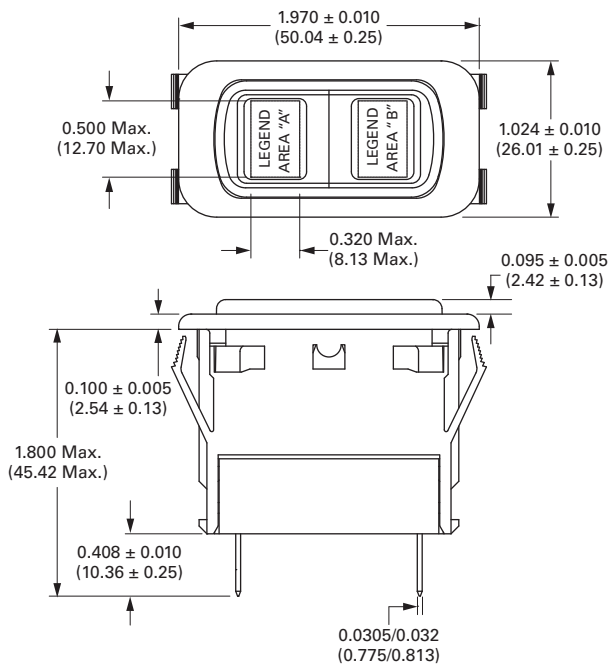

Label Rocker

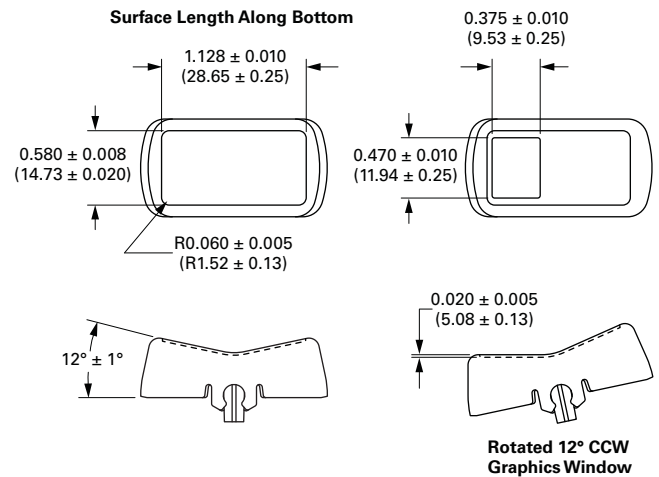

Note: Graphics window may be on both ends or either end of part. Dimensions shown are typical.

SVR—Sealed Vehicle Rocker

2



Product Description

The Sealed Vehicle Rocker (SVR) switch from Eaton’s electrical business now offers an above panel actuator style in addition to the below panel and paddle actuators. Designed to meet the severe environmental requirements of the construction and agricultural vehicle markets, the SVR is sealed at the front and back of the switch and meets the rigorous sealing requirements of IP68.

The small switch footprint minimizes the space taken on switch panels. SVR switches are assembled into panels by pressing the switch through the top of the panel and are held in place by retention tabs molded into the body of the switch; mounting hardware or special tools are not necessary.

The SVR is offered in single- and two-pole switch circuits, with two- and three-position momentary and maintained circuits available. Switch and illumination circuits are terminated with 0.11 in (2.8 mm) tin-plated copper alloy spade terminals. The SVR connector can be loaded with the appropriate terminals and/or wire seals to accomplish sealing at the back end of the switch.

Contents

Description

	<i>Page</i>
SVR—Sealed Vehicle Rockers	
Above Panel Rocker Switch	V11-T2-34
Below Panel Rocker Switch	V11-T2-35
Technical Data and Specifications	V11-T2-36
Circuit Diagrams	V11-T2-37
Dimensions	V11-T2-38

Features

You can order assembled switches or the switch base and actuator separately.

Use the final code in the switch base catalog number, **Pages V11-T2-34** and **V11-T2-35**, to denote assembly instructions.

Actuator

The SVR switch family includes three styles of actuators: above panel, below panel and paddle.

Switch performance and specifications are the same for all actuator styles. Black is standard, but other colors are also available. Matte finish is standard on all actuator styles, matching the finish on the bezels and all other visible SVR switch features and accessories.

Actuator Styles

- Above panel rocker button offers new styling and a larger surface area. Eaton can offer assistance with unique designs of above panel actuators for applications where differentiation is desired
- Below panel rocker button is the same two-faced European styling that has been offered for SVR since its initial release. Indicator style matches the below panel rocker button style
- Paddle actuator allows toggle-type actuation of the SVR switch

Standards and Certifications

- Approvable under stringent UL and CSA standards
- For information, contact your local Eaton Sales Representative
- RoHS Compliant ①



Note

① Visit www.eaton.com/vcbu for the most up-to-date list of verified part numbers.

Illumination

Long life LEDs provide backlighting illumination for the SVR switch. Backlighting can be either independent of or dependent on the switch circuits, or a combination of both. Standard LED color is amber, with red, green and blue also available. LED protection circuitry is available to protect the LED from overvoltage and reverse voltage conditions.

Contact your local Eaton Sales Representative for more specific information about standard and custom circuit options.

Backlighting

- Each switch can accommodate up to two LEDs that can be connected to be either circuit dependent or independent
- Standard LED color is amber, with red, green and blue also available. Long life (100,000 hours) LEDs are standard
- Standard LED voltages are 12 and 24 Vdc
- The below panel rocker button style includes a single-piece back-lit actuator with laser-etched icons in either daylight white or deadfront styles. Without illumination, the icon is either daylight white or deadfront, but will change to the color of the chosen light source when illuminated

Snap-in Lenses

- Above and below panel rocker buttons are available with or without one or two translucent lenses. Five standard lens colors are available: white, red, green, blue and amber

Icons

- Icon areas are provided on each end of the rocker button. Icons may be illuminated or non-illuminated and are pad-printed in a contrasting color either directly on the rocker button or the lens

Mounting Means

Snap-in mounting using four flexible plastic retainers integral with switch frame.

Circuits

The SVR switch is capable of single- or two-pole configurations with two- or three-position maintained, momentary or a combination of actuations.

The addition of jumpers between switch terminals expands the circuit possibilities.

Contact your local Eaton Sales Representative for more specific information about SVR standard and custom circuit options.

Standard Circuit Options

- ON–NONE–ON
- ON–OFF–ON
- ON*–OFF–ON*
- ON*–OFF–ON
- ON–ON–ON
- ON*–NONE–ON
- ON*–ON–ON*
- ON*–ON–ON

Note: * = Momentary. See Electrical Circuit Diagrams on Page V11-T2-37.

Sealing

SVR design includes a sealed contact chamber with dust and water resistance to IP68. The harness connection can also be sealed by using AMP wire seals Catalog Number 828905-1 (14–16 gauge) or 828904-1 (18–20 gauge) to seal the wires to the connector. For an application where a connector cavity is not being used, it can be sealed with AMP sealing plug Catalog Number 828922-1.

The above panel version may also be sealed to the panel using panel seal Catalog Number 32-2245.

Options

- Additional colors of actuators, mounting bezels and lenses
- Special circuits
- Special ratings
- Pad printing on the below panel switch bezel
- Low current capabilities
- Custom back-lit icons
- Gang-mount system including end bezel Catalog Number 17-22146 and center bezel 17-22152
- Palm Guard (below panel switch only) at either or both ends of the switch frame
- Indicators with insertable lenses
- Polarized lock-on connector Catalog Number 25-13936
- Panel plug with connector retention feature Catalog Number 17-22145
- Non-illuminated below panel paddle actuator

Note: Contact your local Eaton Sales Representative for additional information on options.

Above Panel Rocker Switch

2



Catalog Number Selection

How To Order—Above Panel Rocker Switch

To determine complete catalog number, start with the appropriate switch series and add the appropriate code letters and/or numbers.

Example: S AC M 2X D G AT R AC X X

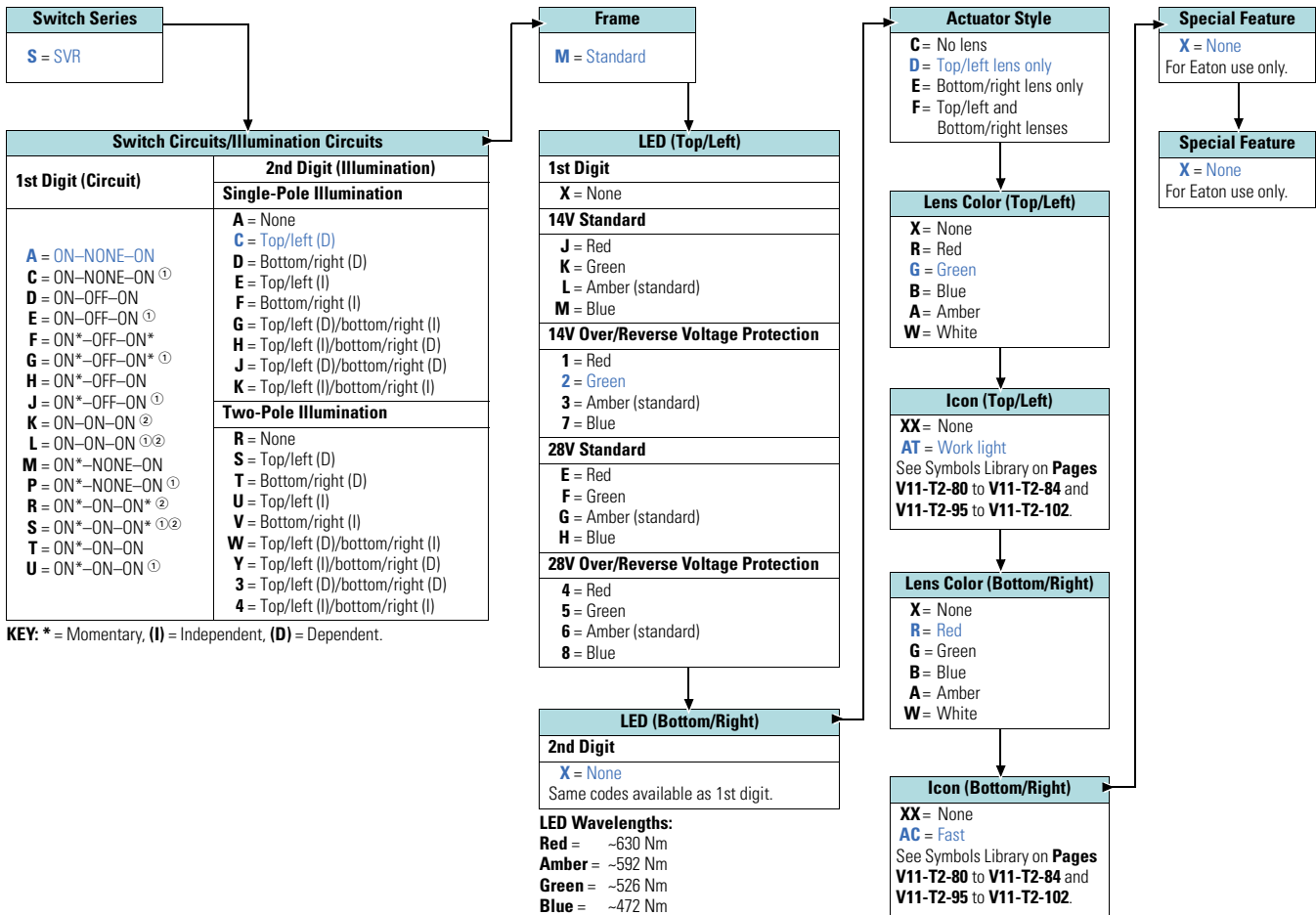

Notes

- ① Gold plated.
- ② Two-pole only. See Electrical Circuit Diagrams on Page V11-T2-37 and Illumination Circuit Diagrams on Page V11-T2-38.



Below Panel Rocker Switch

Catalog Number Selection

How To Order—Below Panel Rocker Switch

To determine complete catalog number, start with the appropriate switch series and add the appropriate code letters and/or numbers.

Example: S AC S 2X 3 G AT R AC X X

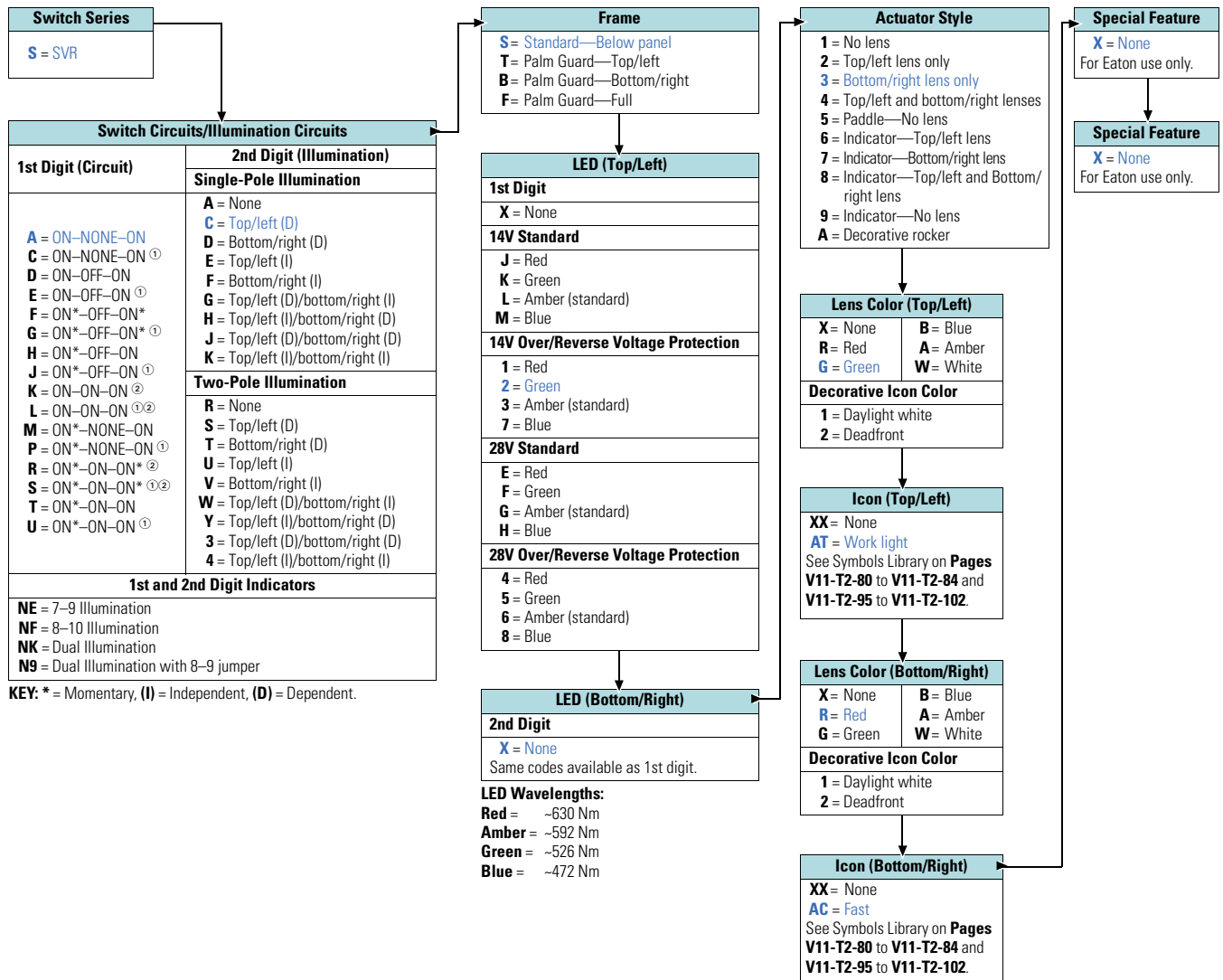

Notes

- ① Gold plated.
- ② Two-pole only. See Electrical Circuit Diagrams on Page V11-T2-37 and Illumination Circuit Diagrams on Page V11-T2-38.

Technical Data and Specifications

2

SVR—Sealed Vehicle Rocker

Description	Specification
Ratings	12A at either 12 or 24 Vdc, can be approved under stringent UL and CSA standards
Electrical life	
Standard plating	50,000 operations at 12A at either 12 or 24 Vdc. Life cycle testing conducted using both inductive and resistive loads
Gold plating	250,000 (maintained circuits)/50,000 (momentary circuits) operations at 10 mA at either 12 or 24 Vdc
Mechanical life	
Maintained circuits	250,000 operations minimum
Momentary circuits	50,000 operations minimum
Circuits	Single- or two-pole, two- or three-position, with momentary and maintained capabilities
Dielectric strength	1500 volts rms minimum
Operate force	1–3 lbs (4.4–13.2 Nm) depending on circuit configuration and actuator style
Temperature	
Operating range	–40° to 185°F (–40° to 85°C)
Storage range	–40° to 185°F (–40° to 85°C)
Contact material	
Movable	Copper alloy with silver alloy contact surface
Stationary	Silver-plated copper alloy with silver alloy contact surface
Gold-plated	Contacts are available for low level electrical loads
Terminal type	Standard 0.11 in (2.8 mm) tin-plated copper alloy spade terminal Mates to AMP Junior Power Timer Terminals ^① Catalog Number 927766-3 (14–16 gauge) Catalog Number 927770-3 (18–20 gauge)
Plastic component UL ratings	
Base material	UL 94 V-0
Frame material	UL 94 H-B
IP rating	IP68
Sub-actuator material	UL 94 V-0
Actuator material	UL 94 V-0 (above panel rocker button) UL 94 H-B (below panel rocker button and paddle actuator)
Mounting hole	Standard panel cutout of 1.45 x 0.83 in (36.8 x 21.1 mm)
Panel thickness	0.04 to 0.16 in (1.0 to 4.0 mm) Best results obtained between 0.06 and 0.12 in (1.5 and 3.0 mm)

Note

^① See also Sealing, **Page V11-T2-33**, for additional AMP components to seal the connector interface.

Circuit Diagrams

Switch Circuit Schematics

Code	Single-Pole Schematic (Shown in Top/left Actuated Position)	TOP/ LEFT Actuated	CENTER	BOTTOM/ RIGHT Actuated
A C (Gold)		ON	NONE	ON
		2-3	—	2-1
D E (Gold)		ON	OFF	ON
		2-3	—	2-1
F G (Gold)		MOM. ON	OFF	MOM. ON
		2-3	—	2-1
H J (Gold)		MOM. ON	OFF	ON
		2-3	—	2-1
K L (Gold)	Two-pole only			
M P (Gold)		MOM. ON	NONE	ON
		2-3	—	2-1
R S (Gold)	Two-pole only			
T U (Gold)		MOM. ON	ON	ON
		2-3	2-1	2-1

Code	Two-Pole Schematic (Shown in Top/left Actuated Position)	TOP/ LEFT Actuated	CENTER	BOTTOM/ RIGHT Actuated
A C (Gold)		ON	NONE	ON
		2-3	—	2-1
		5-6	—	5-4
D E (Gold)		ON	OFF	ON
		2-3	—	2-1
		5-6	—	5-4
F G (Gold)		MOM. ON	OFF	MOM. ON
		2-3	—	2-1
		5-6	—	5-4
H J (Gold)		MOM. ON	OFF	ON
		2-3	—	2-1
		5-6	—	5-4
K L (Gold)		ON	ON	ON
		2-3	5-4-2-3	5-4-2-1
		5-6	—	—
M P (Gold)		MOM. ON	NONE	ON
		2-3	—	2-1
		5-6	—	5-4
R S (Gold)		MOM. ON	ON	MOM. ON
		2-3	5-4-2-3	5-4-2-1
		5-6	—	—
T U (Gold)		MOM. ON	ON	ON
		2-3	2-1	2-1
		5-6	5-4	5-4

Illumination Schematics

Single-Pole Code	Two-Pole Code	Schematic ①
A	R	None
C	S	
D	T	
E	U	
F	V	
G	W	
H	Y	
J	3	
K	4	
Illumination Code		Schematic ①
9		

Note
 ① LED for terminals 7–9 is at top/left side of switch.
 LED for terminals 8–10 is at bottom/right of switch.

Dimensions

Above Panel Rocker

Approximate Dimensions in Inches (mm)

Above Panel Rocker Switch with Actuator

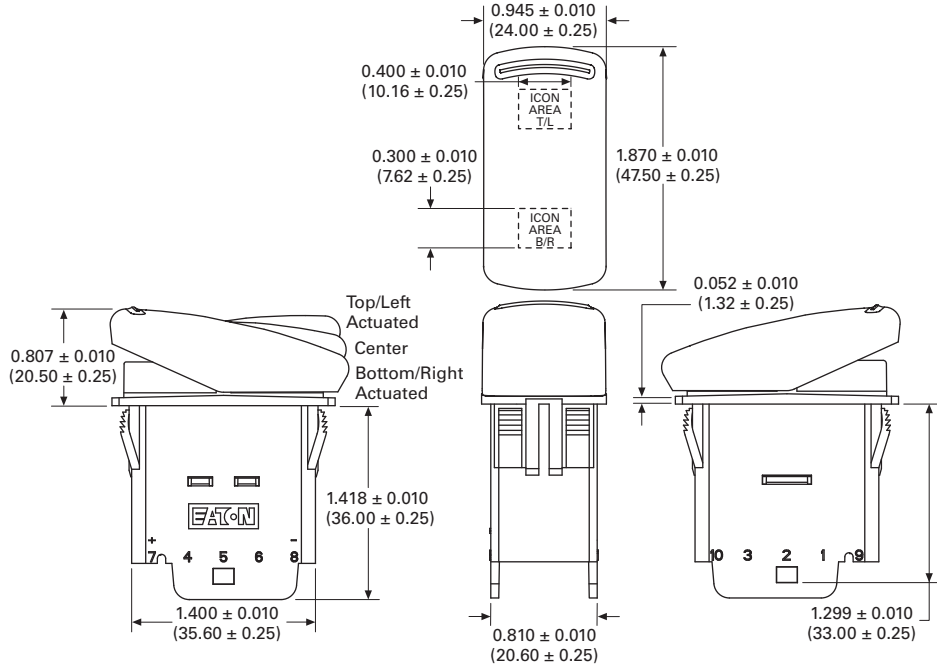

Panel Seal Gasket (Above Only)

Catalog Number 32-2245

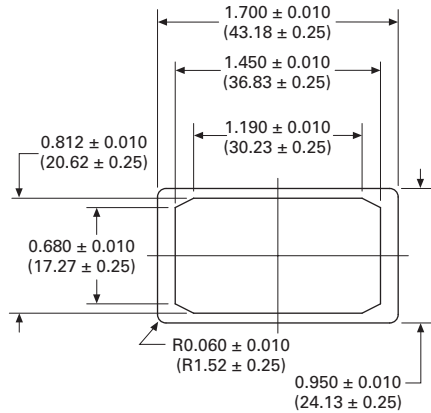

Panel Opening (Above and Below)

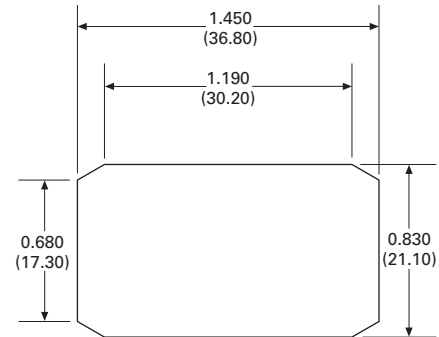

Note: Recommended panel thickness 0.039–0.157 in (1.00–4.00 mm). Best results obtained between 0.059 and 0.118 in (1.50 and 3.00 mm).

Below Panel Rocker

Approximate Dimensions in Inches (mm)

Below Panel Rocker Switch with Actuator

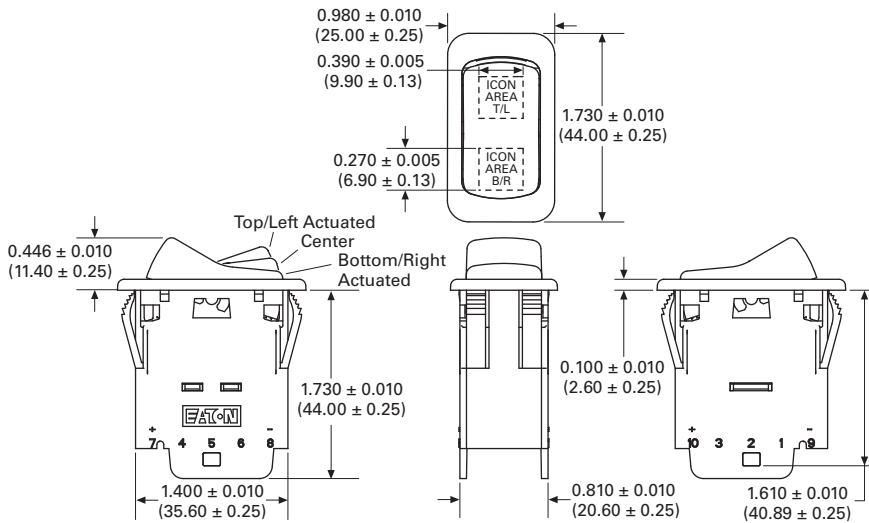

Panel Actuator (Below Panel Only)

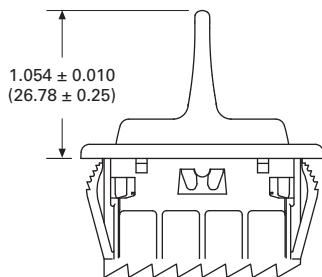

Panel Guard (Below Panel Only)

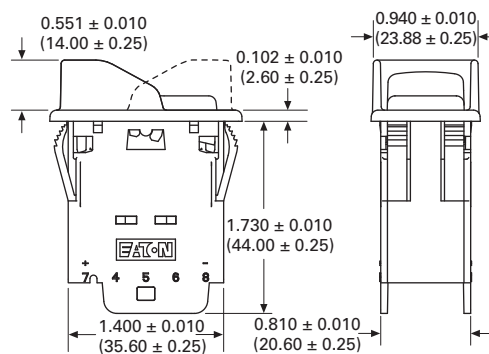

Indicator (Below Panel Only)

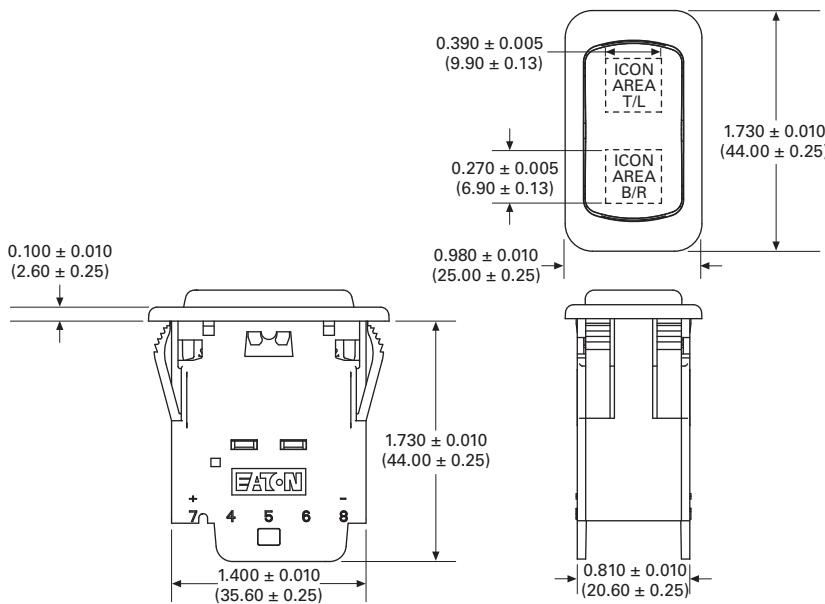

Accessories

Approximate Dimensions in Inches (mm)

2

Gang Mount System

End Bezel Catalog Number 17-22146

Center Bezel Catalog Number 17-22152

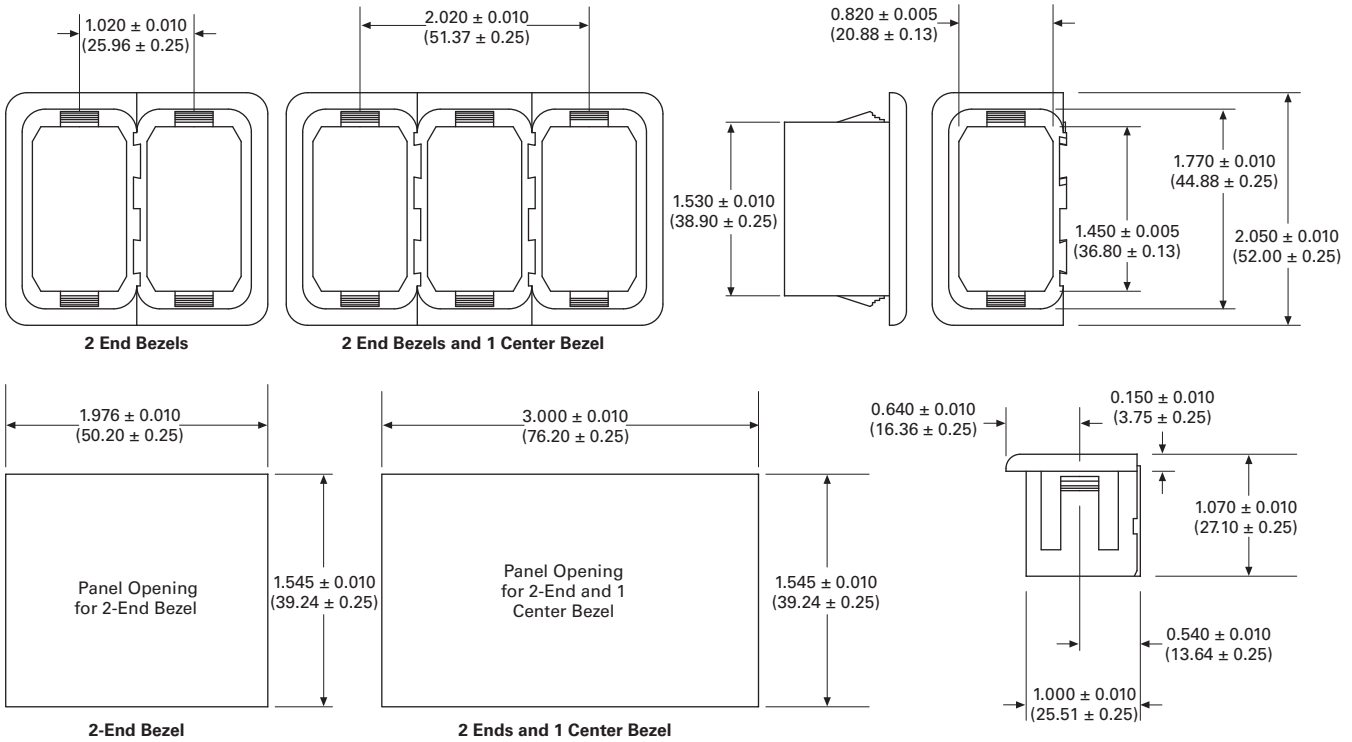

Panel Plug

Catalog Number 17-22145

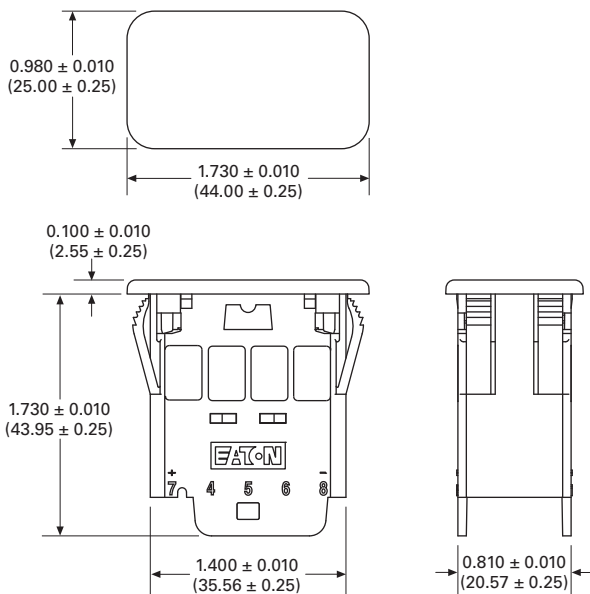

Connector

Catalog Number 25-13936

AMP Terminal Catalog Numbers:
 927766-3 (14–16 gauge)
 927770-3 (18–20 gauge)
 AMP Wire Seal Catalog Numbers:
 828905-1 (14–16 gauge)
 828904-1 (18–20 gauge)
 AMP Sealing Plug Catalog Number:
 828922-1

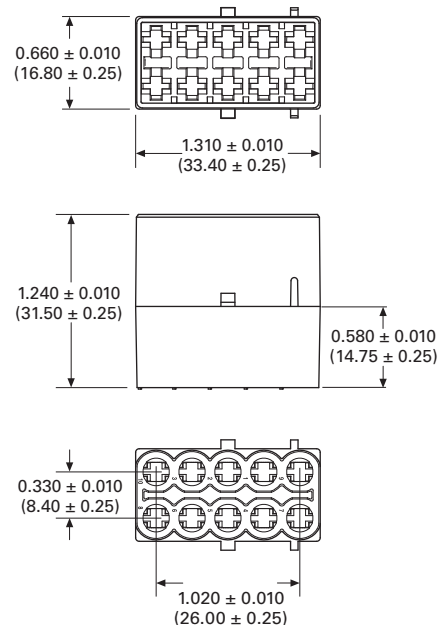

Dual Motion Safety Switch



Contents

Description

Page

Dual Motion Safety Switches	
Catalog Number Selection	V11-T2-42
Dimensions	V11-T2-42

Product Description

Eaton's Vehicle Control business offers these new dual motion safety switches to prevent accidental actuation and protect operator personnel and equipment.

These rockers are available in two standard circuit options: OFF (locked)—None—ON and ON (locked)—None—ON. The locked safety feature requires two motions from the operator to place the actuator in the unlocked position. In the locked position, the operator must apply pressure on the actuator forward and an additional force in an upward motion for the switch to be moved to the unlocked position. Once in the unlocked position, the switch can easily be moved back into the locked position.

Application Description

- Farming equipment
- Fire trucks and safety vehicles
- Lawn and garden equipment
- Large transportation buses
- Industrial and commercial equipment

Features and Benefits

Dual motion safety switches are recommended up to 15A at 28 Vdc. An added benefit is its IP54 seal level. They can be used in tough environments where there may be exposure to small dust particles or water splashing against the enclosure from any direction. For available higher ratings or additional customizable circuits, please contact your local Eaton Sales Representative.

Options

There are many options to choose when building the right switch for your application. Termination types to choose from include screw type, solder lug and 0.250-inch spade terminals. Actuators are available in four standard colors with an appealing matte finish. Choose from black, red, white or yellow. Eaton also offers standard and customizable legend pad printing options on top of the actuator. There is even an option for arrows to be pad printed on the sides of the rocker to indicate the correct forward motion.

For added convenience, the bezel is designed to allow an easy snap-in switch mount into various panel thicknesses. The actuators even have ergonomic grooves to help provide the operator a firm grip when moving the actuator.

Standards and Certifications

- UL/CSA Recognition at 15A, 125 Vac; 10A, 250 Vac; 3/4 hp, 250 Vac
- RoHS Compliant ①



Note

① Visit www.eaton.com/vc bu for the most up-to-date list of verified part numbers.

2.4

Rockers

Dual Motion Safety Switches

Catalog Number Selection

2

8179K21Z T 51 AA A Y

Poles and Throws	Circuit with Rocker In ...			Base Part Number
	Position A	Center Position	Position B	
2PST 2PDT	OFF (lock) ON (lock)	None None	ON ON	8179K21Z 8179K22Z

Rocker Color
Y = Black
T = Red
M = White
E = Yellow

Termination Type
50 = Screw type
51 = Solder lug
52 = Quick connect (0.250 in spade)

Top Pad Print ^①
XX = None
AA = PTO
AB = Creeper engage
AC = Retarder
AD = Windrower ON/OFF
AE = Rotary lock pin cylinder

Side Arrow Pad Prints
X = None
Y = Both sides

Icon Orientation
A = Standard
B = 90° clockwise
C = 180° clockwise
D = 270° counterclockwise
X = None

Available Switch Pad Prints

Prints^②

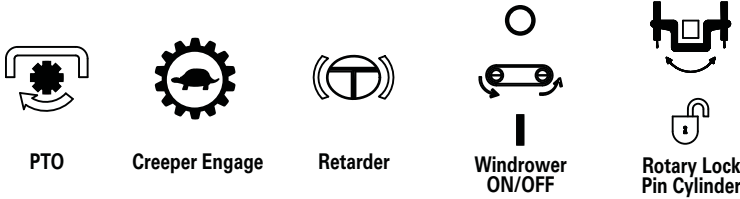

Dimensions

Approximate Dimensions in Inches (mm)

Dual Motion Safety Switch

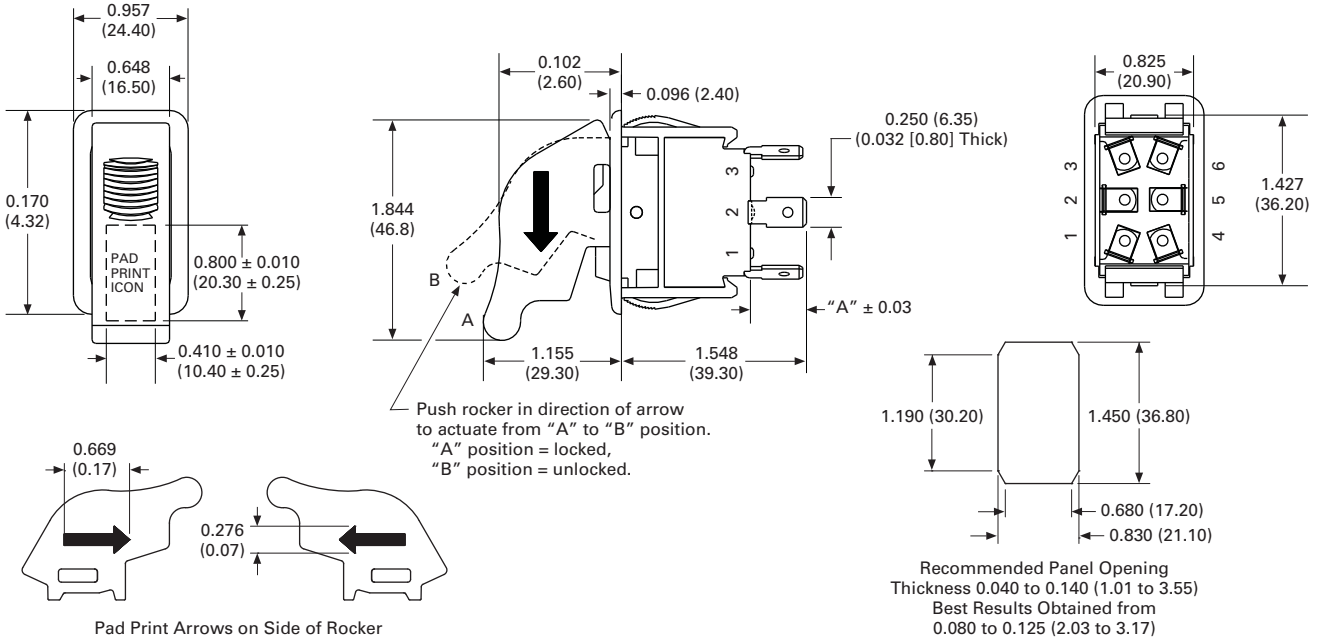

Notes

- ① Black pad print color for white and yellow rockers. White pad print color for red and black rockers.
- ② Contact your local Eaton Sales Representative for more available pad print options.

1500/2500 Series



Contents

<i>Description</i>	<i>Page</i>
1500/2500—Midsize AC Rated	
Midsize Non-Illuminated and Illuminated	V11-T2-44
Hi-Lite Rocker with High Inrush	V11-T2-45
Technical Data and Specifications	V11-T2-46
Dimensions	V11-T2-46

Product Description

Eaton’s 1500/2500 series rocker switch offers a designer touch that will enhance any product line.

Ideal applications include appliances, electronic instrumentation, data processing, communications and medical and office equipment. Custom legends are available on the switch actuator and bezel.

Options

High Inrush Option

The 1500H/2500H is designed to handle high inrush currents up to 100A peak inrush for 10 milliseconds.

Hi-Lite Rocker with High Inrush Option

This two-color rocker version brightly indicates the ON position. This version spares the expense of more costly illuminated switches and is available with the high inrush option.

Standards and Certifications

Note: See Catalog Number Selection for more detail.

International Approvals

- UL Recognized
- CSA Certified
- ENEC
- RoHS Compliant ①



Note

① Visit www.eaton.com/vcbu for the most up-to-date list of verified part numbers.

2.5

Rockers

1500/2500—Midsize AC Rated

Midsize Non-Illuminated and Illuminated

To determine complete catalog number, start with the appropriate base circuit number and add the appropriate code letters and/or numbers.



2

Catalog Number Selection

How To Order—Midsize Non-Illuminated

Example: **1500** → **2 1 E 038**

Rating	Poles and Throw	Circuit with Rocker in ...			Base Circuit Number ^②	Circuit Number ^③
		UP Position	CENTER Position	DOWN Position ^①		
UL/CSA: 15A 125 Vac, 10A 250 Vac, 10A 28 Vdc, 8A 14VT; ENEC: 10(4)A 250V	1PST	ON MOM. ON ON	NONE NONE NONE	OFF OFF MOM. OFF	1500 1501 1505	1 3 4
	1PDT	ON ON	NONE NONE	ON MOM. ON	1502 1503	5 7
UL/CSA: 15A 125 Vac, 10A 250 Vac, 10A 28 Vdc, 8A 14VT; ENEC: 10(2)A 250V	1PDT	ON	OFF	ON	1504	6
UL/CSA: 10A 125 Vac, 10A 250 Vac, 10A 28Vdc, 8A 14VT; ENEC: 10(2)A 250V	1PDT	MOM. ON MOM. ON	OFF OFF	MOM. ON ON	1506 1507	9 8
	2PST	ON MOM. ON ON	NONE NONE NONE	OFF OFF MOM. OFF	2500 2501 2505	10 11 12
UL/CSA: 15A 125 Vac, 10A 250 Vac, 10A 28 Vdc, 8A 14VT; ENEC: 10(4)A 250V	2PDT	ON ON	NONE NONE	ON MOM. ON	2502 2503	13 15
	2PDT	ON	OFF	ON	2504	14
UL/CSA: 10A 125 Vac, 10A 250 Vac, 10A 28 Vdc, 8A 14VT; ENEC: 10(2)A 250V	2PDT	MOM. ON MOM. ON	OFF OFF	MOM. ON ON	2506 2507	17 16

Code letters and/or numbers.
Add to base circuit number.

Base and Bezel Color
1 = Black
2 = White
3 = Red

Rocker Color
1 = Black
2 = White
3 = Red

Terminal Type
E = 6.3 mm tabs/0.25 in quick connect
B = Solder lugs

Note: B style terminal not offered for 1506 Series.

Legend Type (Optional)
038 = ON/OFF
See Most Popular Legends table on Page V11-T2-53.

How To Order—Midsize Illuminated

Example: **2500** → **G 2 2 E 725**

Rating	Poles and Throw	Circuit with Rocker in ...			Base Circuit Number ^③	Circuit Number ^③
		UP Position	CENTER Position	DOWN Position ^①		
UL/CSA: 15A 125 Vac, 10A 250 Vac, 10A 28Vdc, 8A 14VT; ENEC: 10(4)A 250V	1PST	ON MOM. ON	NONE NONE	OFF OFF	1500 1501	18 21
	2PST	ON MOM. ON	NONE NONE	OFF OFF	2500 2501	28 30

Code letters and/or numbers.
Add to base circuit number.

Lens/Rocker Color
A = Amber
G = Green
R = Red
W = White (clear)

Lamp Voltage
0 = No lamp
1 = 125V neon
2 = 250V neon
4 = 6V filament^④
5 = 12V filament^④

Base and Bezel Color
1 = Black
2 = White
3 = Red

Terminal Type
E = 6.3 mm tabs/0.25 in quick connect
B = Solder lugs

Legend Type (Optional)
725 = ON/OFF
See Most Popular Legends table on Page V11-T2-53.

Notes

- ① 1500 Type—Lever depressed toward terminal #3. 2500 Type—Lever depressed toward terminals #13 and #26.
- ② #1500—#1507 switches are supplied in 1500 type base. #2500—#2507 switches are supplied in 2500 type base.
- ③ See Circuit Diagrams on Page V11-T2-78.
- ④ 6V, 12V filament lamps are not UL, CSA, or ENEC.



Hi-Lite Rocker with High Inrush

To determine complete catalog number, start with the appropriate base circuit Type and add the appropriate code letters and/or numbers.

Catalog Number Selection

How To Order—Hi-Lite Rocker with High Inrush Option

Example: **1500H** → **1 2 4 E 038**

Rating	Poles and Throw	Circuit with Rocker in ...			Base Circuit Number	Circuit Number
		UP Pos.	CENTER Position	DOWN Position ①		
UL/CSA: 15A 125 Vac, 10A 250 Vac, 10A 28 Vdc, 8A 14VT; ENEC: 10(4)A 250V	1PST	ON	NONE	OFF	1500	1
	MOM. ON	NONE	OFF	1501	3	
UL/CSA: 22A 125 Vac, 16A 250 Vac, 6A 125 VacL, 10A 14VT, 1 hp 125-250Vac; ENEC: 16(4)A 250V	1PST	ON	NONE	OFF	1500H	1

Code letters and/or numbers. Add to Base Circuit Number.

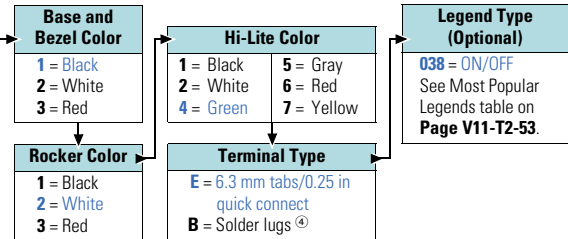

How To Order—High Inrush, Non-Illuminated

Example: **1500H** → **1 2 E 038**

Rating	Poles and Throw	Circuit with Rocker in ...			Base Circuit Number	Circuit Number
		UP Pos.	CENTER Position	DOWN Position ①		
UL/CSA: 22A 125 Vac, 16A 250 Vac, 6A 125 VacL, 10A 14VT, 1 hp 125-250 Vac; ENEC: 16(4)A 250V	1PST	ON	NONE	OFF	1500H	1
	2PST	ON	NONE	OFF	2500H	10

Code letters and/or numbers. Add to Base Circuit Number.

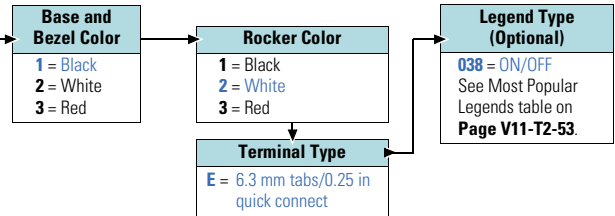

How To Order—High Inrush Illuminated

Example: **2500H** → **G 2 2 E 725**

Rating	Poles and Throw	Circuit with Rocker in ...			Base Circuit Number	Circuit Number
		UP Pos.	CENTER Position	DOWN Position ①		
UL/CSA: 22A 125 Vac, 16A 250 Vac, 6A 125 VacL, 10A 14VT, 1 hp 125-250 Vac; ENEC: 16(4)A 250V	1PST	ON	NONE	OFF	1500H	18
	2PST	ON	NONE	OFF	2500H	28

Code letters and/or numbers. Add to Base Circuit Number.

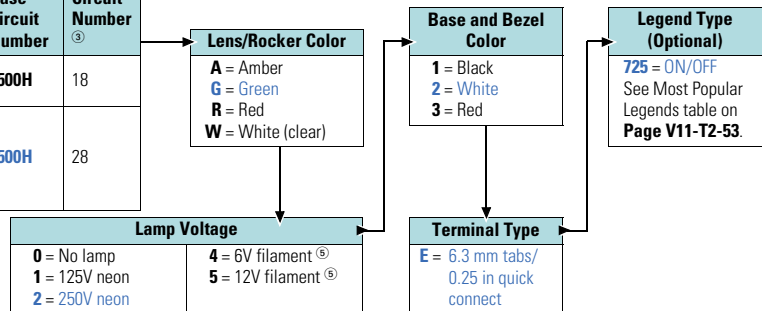

Notes

- ① 1500 Type—Lever depressed toward terminal #2. 1500H Type—Lever depressed toward terminal #3. 2500H Type—Lever depressed toward terminals #13 and #26.
- ② High inrush capabilities available only on basic catalog numbers beginning with 1500H.
- ③ See Circuit Diagrams on Page V11-T2-78.
- ④ Standard rating only.
- ⑤ 6V, 12V filament lamps are not UL, CSA, or ENEC.

Technical Data and Specifications

2

1500/2500—Midsize AC Rated

Description	Specification
Ratings	See selection tables on Pages V11-T2-44 and V11-T2-45.
Seal level	IP40
Circuits	
Standard	1PST, 1PDT, 2PST, 2PDT, maintained and momentary
High inrush option	1PST, 2PST, maintained
Hi-lite option	1PST, maintained
Contact mechanism	
Standard	Slow-make/slow-break butt contact
High inrush option	Slow-make/slow-break butt contact with mechanical break
Make—High inrush option	100A peak inrush at 250 Vac for 10 ms for 10,000 cycles minimum
Break—High inrush option	16A, 250 Vac for 10,000 cycles minimum
Contact material	Silver inlay over copper
Contact resistance	10M ohms max. at 1A, 4 Vdc

Description	Specification
Mechanical life	50,000 cycles minimum
Insulation resistance	50M ohms minimum
Dielectric withstand	1000V rms minimum
Terminal types	
Standard	6.3 mm Tabs/0.250 in Quick Connect
Optional	Solder lug
Termination material	
Common (center)	Copper fine silver-plated
End	Copper
Lamp	Brass
Mounting	See dimensions below
Operating temperature range	32° to 185°F (0° to 85°C)

Dimensions

Approximate Dimensions in Inches (mm)

1500/1500H Type Base

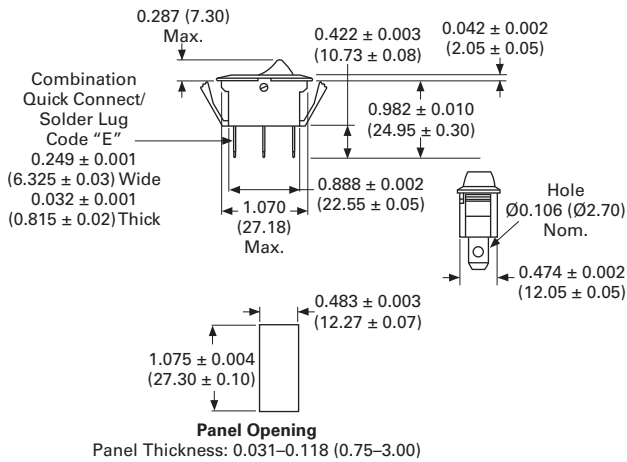
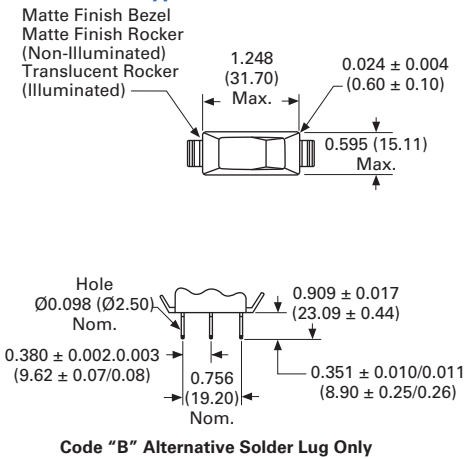

2500/2500H Type Base

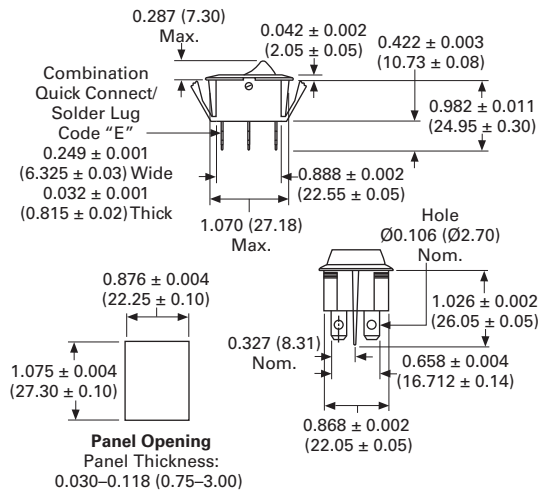
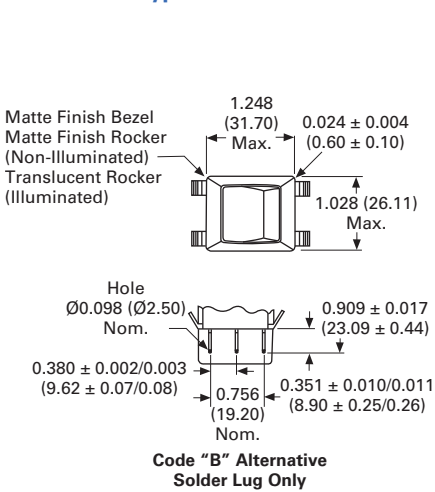

1600/2600 Series



Contents

<i>Description</i>	<i>Page</i>
1600/2600—Midsize AC Only	
Non-Illuminated Rocker	V11-T2-48
Illuminated Rocker	V11-T2-49
Splashguard	V11-T2-50
High Inrush Rockers	V11-T2-51
Technical Data and Specifications	V11-T2-52
Dimensions	V11-T2-52
Accessories	V11-T2-53
Legends	V11-T2-53

Product Description

Eaton’s 1600/2600 series of midsize snap-in rocker and paddle switches have worldwide approvals at up to 16A, 250 Vac. One switch can be used for both domestic and foreign markets.

Ideal applications include appliances, electronic instrumentation, data processing, communications, medical equipment, office equipment and many more. A wide circuit variety is offered in a choice of standard and custom colors for illuminated and non-illuminated versions. Custom legends are available on the switch lever and bezel. High inrush and splashguard are also available.

Options

High Inrush Option

The 1600H/2600H is designed to handle high inrush currents up to 100A peak inrush for 10 milliseconds.

Splashguard Option

This version features a uniquely designed seal that resists moisture and water, making it ideally suited for marine, RV and food processing applications. The oversized nylon lever with smooth, matte finish features a convenient thumb depression to ensure effortless touch control. Two-pole switches feature both a thumb depression and a convex curve. See **Page V11-T2-50**.

Standards and Certifications

Note: See Catalog Number Selection for more detail.

International Approvals

- UL Recognized
- CSA Certified ①
- ENEC
- RoHS Compliant ②



Notes

- ① Splashguard option is cRU marked only.
- ② Visit www.eaton.com/vcbu for the most up-to-date list of verified part numbers.



Non-Illuminated Rocker

To determine complete catalog number, start with the appropriate base circuit number and add the appropriate code letters and/or numbers.

Catalog Number Selection

How To Order—Non-Illuminated Rocker

Example: **1600** → **M 2 1 E 038**

Rating	Poles and Throw	Circuit with Rocker in ...			Base Circuit Number		Circuit Number ③
		UP Position	CENTER Position	DOWN Position ②	Rocker	Paddle ①	
UL/CSA: 16A 125–250 Vac, 10A 28 Vdc, 8A 14VT; ENEC: 16(4)A 250V	1PST	ON MOM. ON	NONE NONE NONE	OFF OFF MOM. OFF	1600 1601 1605	P1600 P1601 P1605	1 3 4
	1PDT	ON ON	NONE NONE	ON MOM. ON	1602 1603	P1602 P1603	5 7
UL/CSA: 16A 125–250 Vac, 10A 28 Vdc, 8A 14VT; ENEC: 10(2)A 250V	1PDT	ON	OFF	ON	1604	P1604	6
UL/CSA: 10A 125–250 Vac, 10A 28 Vdc, 8A 14VT; ENEC: 10(2)A 250V	1PDT	MOM. ON MOM. ON	OFF OFF	MOM. ON ON	1606 1607	P1606 P1607	9 8
		UL/CSA: 16A 125–250 Vac, 10A 28 Vdc, 8A 14VT; ENEC: 16(4)A 250V	2PST	ON MOM. ON ON	NONE NONE NONE	OFF OFF MOM. OFF	2600 2601 2605
UL/CSA: 16A 125–250 Vac, 10A 28 Vdc, 8A 14VT; ENEC: 16(4)A 250V	2PDT	ON ON	NONE NONE	ON MOM. ON	2602 2603	P2602 P2603	13 15
		UL/CSA: 16A 125–250 Vac, 10A 28 Vdc, 8A 14VT; ENEC: 10(2)A 250V	2PDT	ON	OFF	ON	2604
UL/CSA: 10A 125–250 Vac, 10A 28 Vdc, 8A 14VT; ENEC: 10(2)A 250V	2PDT	MOM. ON MOM. ON	OFF OFF	MOM. ON ON	2606 2607	P2606 P2607	17 16

Code letters and/or numbers.
Add to base circuit number.

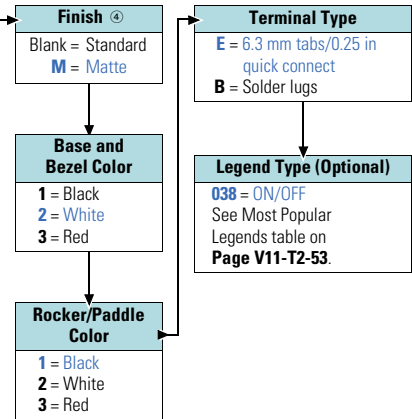

Notes

- ① Paddles are UL, CSA only.
- ② 1600 Type—Lever depressed toward terminal #3.
2600 Type—Lever depressed toward terminals #13 and #26.
- ③ See Circuit Diagrams on **Page V11-T2-78**.
- ④ To order the standard, add a "dash" to the catalog number. Example: 1600–11E.



Illuminated Rocker

To determine complete catalog number, start with the appropriate base circuit number and add the appropriate code letters and/or numbers.

Catalog Number Selection

How To Order—Illuminated Rocker

Example: **1621 X** → **W 5 3 E 038**
 X = Independent lamp

Rating	Poles and Throw	Circuit with Rocker in ...			Base Circuit Number ②	Circuit Number ③
		UP Position	CENTER Position	DOWN Position ①		
UL/CSA: 16A 125–250 Vac, 10A 28 Vdc, 8A 14VT; ENEC: 16(4)A 250V	1PST	ON	NONE	OFF	1600 1601 1620X 1621X 1625X	18
		MOM. ON	NONE	OFF		21
	1PDT	ON	NONE	OFF	1622X 1623X	20
		MOM. ON	NONE	MOM. OFF		④
	1PDT	ON	NONE	ON	1624X	④
		MOM. ON	OFF	MOM. ON		④
UL/CSA: 10A 125–250 Vac, 10A 28 Vdc, 8A 14VT; ENEC: 10(2)A 250V	1PDT	MOM. ON	OFF	MOM. ON	1626X 1627X	④
		MOM. ON	OFF	ON		④
UL/CSA: 16A 125–250 Vac, 10A 28 Vdc, 8A 14VT; ENEC: 16(4)A 250V	2PST	ON	NONE	OFF	2600 2601 2605	28
		MOM. ON	NONE	OFF		30
		ON	NONE	MOM. OFF		31
—	—	Indicator	—	—	1609	32

Code letters and/or numbers.
 Add to base circuit number.

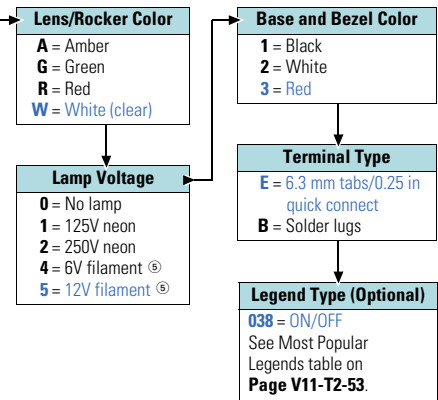

Notes

- ① 1600 Type—Lever depressed toward terminal #3.
 2600 Type—Lever depressed toward terminals #13 and #26.
- ② #1600—#1609 switches are supplied in 1600 type base.
 #1620—#1627 switches are supplied in 2600 type base. (Must have an “X” code.)
 #2600—#2605 switches are supplied in 2600 type base.
- ③ See Circuit Diagrams on **Page V11-T2-78**.
- ④ All independent lamps for IP switches to be assembled from terminal positions #24 and #26.
- ⑤ 6V, 12V filament lamps are not UL, CSA, or ENEC.

2.6

Rockers

1600/2600—Midsize AC Only

2



Splashguard

To determine complete catalog number, start with the appropriate base circuit number and add the appropriate code letters and/or numbers.

Catalog Number Selection

How To Order—Splashguard^①

Example: **B1600** → **1 2 E**

Rating ^②	Poles and Throw	Circuit with Rocker in ...			Base Circuit Number	Circuit Number ^③
		UP Position	CENTER Position	DOWN Position		
16A, 125 Vac 10A, 250 Vac	1PST	NONE	OFF	ON	B1600	1
		NONE	OFF	MOM. ON	B1601	2
	1PDT	NONE	ON	ON	B1602	5
		ON	OFF	ON	B1604	6
10A, 125 Vac 10A, 250 Vac	1PDT	MOM. ON	OFF	MOM. ON	B1606	9
		MOM. ON	OFF	ON	B1607	8
16A, 125 Vac 10A, 250 Vac	2PST	NONE	OFF	ON	B2600	10
		NONE	OFF	MOM. ON	B2601	11
16A, 125 Vac 10A, 250 Vac	2PDT	NONE	ON	ON	B2602	13
		ON	OFF	ON	B2604	14
10A, 125 Vac 10A, 250 Vac	2PDT	MOM. ON	OFF	MOM. ON	B2606	17
		MOM. ON	OFF	ON	B2607	16

Code letters and/or numbers.
Add to base circuit number.

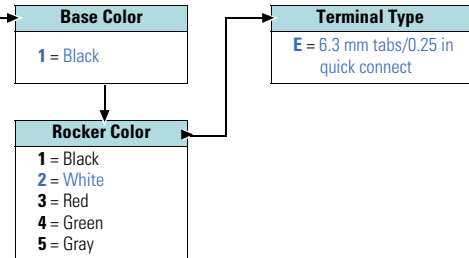

Dimensions

Approximate Dimensions in Inches (mm)

Splashguard

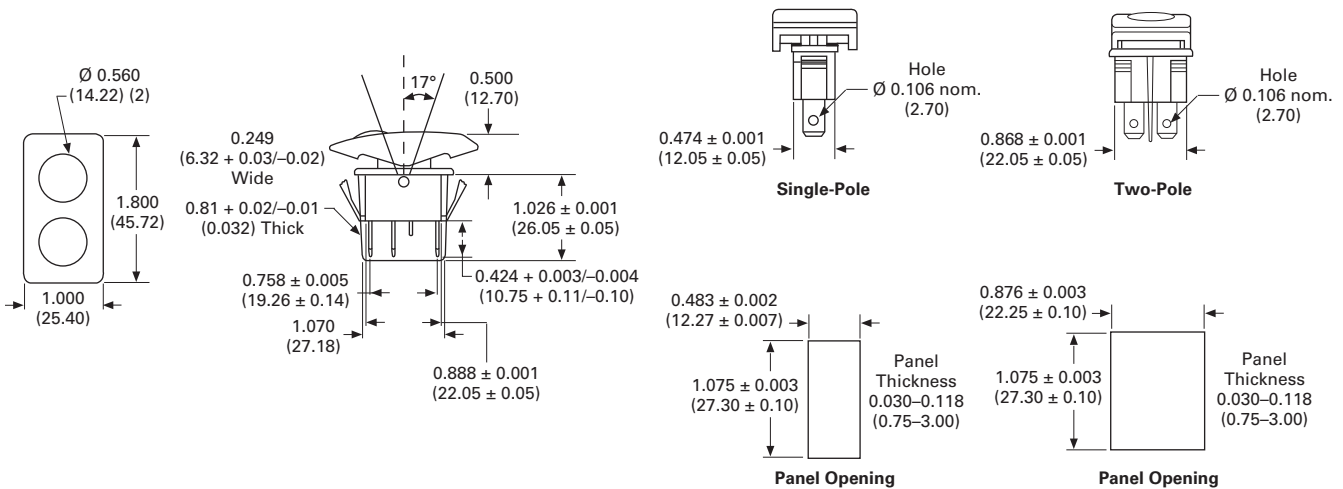

Notes

- ① Splashguard is CUR marked, but does not have ENEC approval.
- ② All circuits also recommended 10A, 28 Vdc.
- ③ See Circuit Diagrams on **Page V11-T2-78**.



High Inrush Rockers

To determine complete catalog number, start with the appropriate base circuit number and add the appropriate code letters and/or numbers.

Catalog Number Selection

How To Order—Non-Illuminated High Inrush Rockers

Example: **1600H** → **M 2 1 E 038**

Rating	Poles and Throw	Circuit with Rocker in ...			Base Circuit Number ^⑤	Circuit Number ^⑤
		UP Position	CENTER Position	DOWN Position ^②		
UL/CSA: ① 22A 125 Vac, 16A 250 Vac, 6A 125 VacL, 10A 14VT, 1 hp 125–250 Vac; ENEC: 16(4)A 250V	1PST	ON ON	NONE NONE	OFF OFF	1600H 1620H ^③	1 2
	2PST	ON	NONE	OFF	2600H	10

Code letters and/or numbers.
Add to base circuit number.

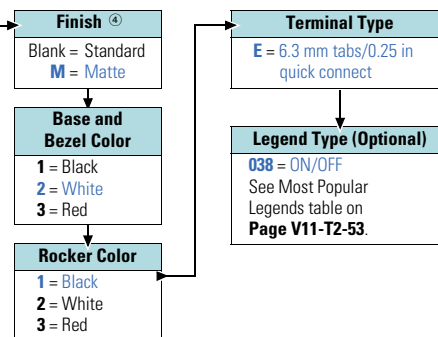

How To Order—Illuminated High Inrush Rockers

Example: **1600H** → **R 2 1 E 038**

Rating	Poles and Throw	Circuit with Rocker in ...			Base Circuit Number ^⑤	Circuit Number ^⑤
		UP Position	CENTER Position	DOWN Position ^②		
UL/CSA: ① 22A 125 Vac, 16A 250 Vac, 6A 125 VacL, 10A 14VT, 1 hp 125–250 Vac; ENEC: 16(4)A 250V	1PST	ON ON	NONE NONE	OFF OFF	1600H 1620HX ^⑥	18 19
	2PST	ON	NONE	OFF	2600H	28
—	—	Indicator	Indicator	—	1609	32

Code letters and/or numbers.
Add to base circuit number.

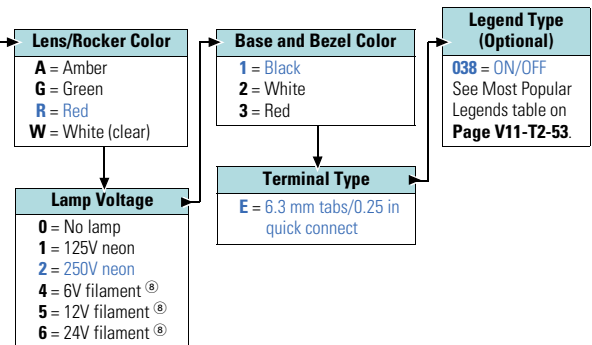

Notes

- ① UL, CSA: 1 hp at 125V or 250 Vac; 6A, 125 Vac (L) rating; 10A, 14 Vdc. Marked on request only.
- ② 1600H Type—Rocker depressed toward terminal #2.
2600H Type—Rocker depressed toward terminals #13 and #26.
- ③ 1620H switch is supplied in 2600H base.
- ④ No code required.
- ⑤ See Circuit Diagrams on Page V11-T2-78.
- ⑥ 1620H switch is supplied in 2600H type base. (Must have “X” code.)
- ⑦ 1600H Type—Rocker depressed toward terminal #3.
1620H Type—Rocker depressed toward terminals #13 and #26.
2600H Type—Rocker depressed toward terminals #13 and #26.
- ⑧ 6V, 12V, 24V filament lamps are not UL, CSA, or ENEC.

Technical Data and Specifications

1600/2600—Midsize AC Rated

2

Description	Specification
Ratings	See selection tables on Pages V11-T2-48 to V11-T2-51.
Circuits	
Standard	1PST, 1PDT, 2PST, 2PDT maintained and momentary
High inrush option	1PST, 2PST maintained
Contact mechanism	
Standard	Slow-make/slow-break butt contact
High inrush option	Slow-make/slow-break butt contact with mechanical break
Make—High inrush option	100A, 250 Vac for 10 ms for 10,000 cycles min.
Break—High inrush option	16A, 250 Vac for 10,000 cycles min.
Contact material	Silver inlay over copper
Contact resistance	10M ohms max. at 1A, 4 Vdc
Mechanical life	50,000 cycles minimum

Description	Specification
Insulation resistance	100M ohms minimum
Dielectric withstand	1000V rms minimum
Terminal types	
Standard	6.3 mm tabs/0.250 in quick connect
Optional	Solder lug
Termination material	
Common (center)	Copper fine silver-plated
End	Copper
Lamp	Brass
Mounting	See dimensions below
Operating temperature range	32° to 185°F (0° to 85°C)

Dimensions

Approximate Dimensions in Inches (mm)

1600/1600H Type Base

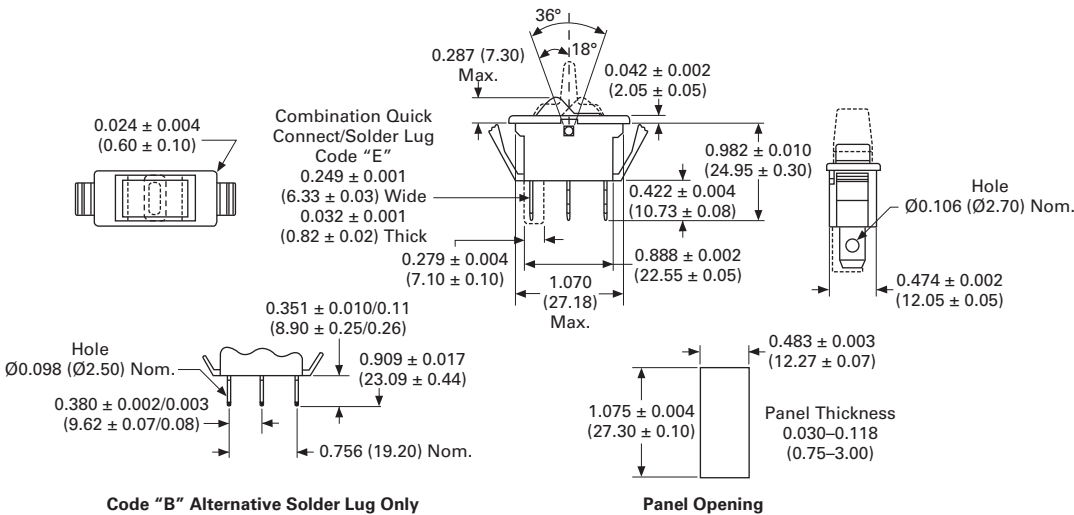

2600/2600H Type Base

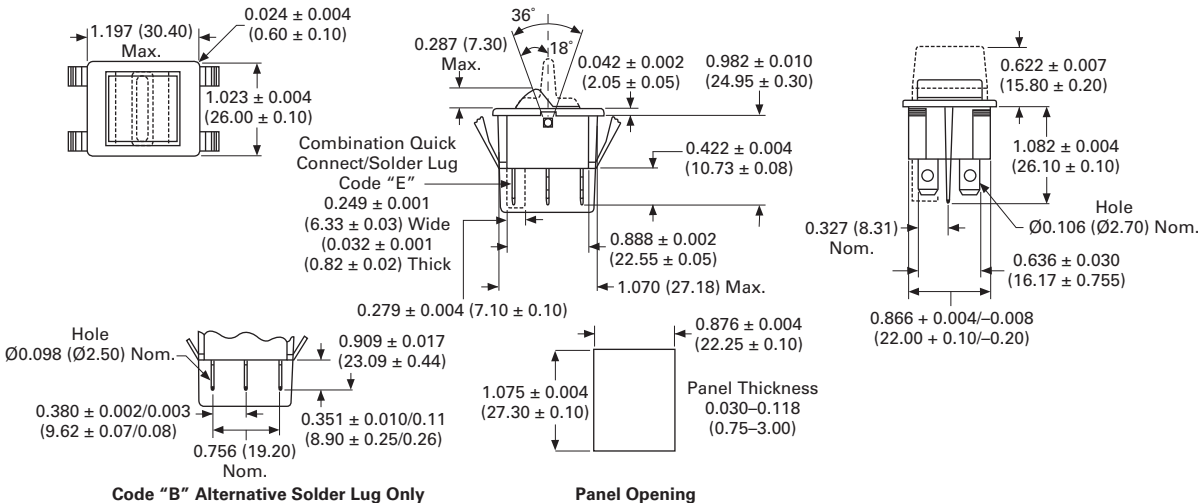

Accessories

Panel Cutout Fillers

If panel cutout fillers are required in anticipation of future rocker or paddle switch installation, order Catalog Number 1609DUM.

Specify color of base and filler portion by using the standard two-digit color code (base and lever) for non-illuminated switches.

Example: 1609DUM11

Legends

How To Order—Legends

To order a rocker with a legend marking, add the three-character code to the end of the catalog number. Example: 1500-21E becomes 1500-21E038.

Legends are for 1500/2500 and 1600/2600 only.

Most Popular Legends ^①

Legend	Code	Legend	Code	Legend	Code	Legend	Code
	014		653		714		735
	023		656		725		746
	038		657		730		752
	039		671		734		760
	630						

Note

^① For additional legend options, contact your local Eaton Sales Representative.

Rockette Series

2



Product Description

These rocker switches offer the widest selection of features available, providing the design flexibility needed to fill the requirements of a variety of applications. They are available in two versions: standard and sealed.

The Sealed Rockette features a silicone rubber seal that protects contacts and mechanisms. All switches resist contaminants such as sand, dust and moisture with both a base-to-frame seal and an actuator seal. Non-illuminated and illuminated versions are available. For Sealed Rockette selection, see table on **Page V11-T2-56**.

Features and Benefits

- Voltages
 - 110 Vac neon
 - 14 Vdc and 28 Vdc

On the illuminated version, the lamp is wired to operate in conjunction with the switch on single-throw circuit; on double-throw circuits, the lamp is independent of the switch

- Mounting
 - Flush (two screws), sub-panel and snap-in mounting
- Snap-in Mounting
 - Convenient front panel or sub-panel snap-in mounting

Available in single- and two-pole non-illuminated or in single-pole illuminated Rockette switches. Contact your local Eaton Sales Representative for three- and four-pole circuits

Unless otherwise noted, all switches with snap-in mounting are UL Recognized and CSA Certified

Contents

<i>Description</i>	<i>Page</i>
Rockette—General Purpose AC Rated	
Standard Rockette Switches	V11-T2-55
Sealed Rockette Switches	V11-T2-56
8058 Series Sealed Rockette Switches	V11-T2-57
Technical Data and Specifications	V11-T2-58
Dimensions	V11-T2-58

Options

Standard and Sealed

- Additional colors of rockers and bezels are available
- Hot stamped or pad printed legends on rocker and bezel
- Paddle actuators
- Single rocker operator on two- and three-pole circuits
- Dry circuits capabilities
- Special ratings
- Reversing jumpers
- Dead back cover (two-pole base) with wire leads
- Special circuits
- Printed circuit terminals and other terminal types
- Metal snap-in bezels
- Foam dust seal

Sealed Only

- Special voltage bulbs
- Industry standard connector available
- Two-pole illuminated circuit

Standards and Certifications

- UL Recognized
- CSA Certified
- RoHS Compliant ^①



Note

^① Visit www.eaton.com/vcbu for the most up-to-date list of verified part numbers.



Standard Rockette Switches

To determine complete catalog number, start with the appropriate base circuit number and add the appropriate code letters and/or numbers.

Catalog Number Selection

How To Order—Standard Rockette Switches

Example: **8132K21** → **E 6 T 50**

Rating	Poles and Throw	Circuit with Rocker in ...			Base Circuit Number ②	Circuit Number ④
		UP Position	CENTER Position	DOWN Position		
6A, 125 Vac 3A, 250 Vac	2PST	ON	NONE	OFF	8132K21 ③	C
	2PDT	ON MOM. ON MOM. ON	OFF NONE OFF	ON MOM. ON ON	8132K20 ③ 8132K22 ③ 8138K20 8138K30	D
15A, 125 Vac 10A, 250 Vac 3/4 hp, 250 Vac	2PST	ON MOM. ON	NONE NONE	OFF OFF	8142K21 8147K21	C
	2PDT	ON MOM. ON MOM. ON	OFF NONE OFF	ON ON MOM. ON ON	8142K20 8142K22 8148K20 8148K30	D
1000W, 125 Vac 10A, 250 Vac	2PST	ON	NONE	OFF	8150K21	C
20A, 250 Vac	2PST	ON	NONE	OFF	8155K21	C
	2PDT	ON ON	OFF NONE	ON ON	8155K20 8155K22	D
6A, 125 Vac 3A, 250 Vac	4PDT	ON	OFF	ON	8130K20 ③	F
	4PST	ON	NONE	OFF	8140K21	E
15A, 125 Vac 10A, 250 Vac ① 3/4 hp, 250 Vac	4PST	ON	OFF	ON	8140K20	F
	4PDT	ON	NONE	ON	8140K22	F

Code letters and/or numbers.
Add to base circuit number.

Mounting Frame ⑤

All Except
**8130K20, 8140K20,
8140K21, 8140K22**

E = Mounting, 2-pole
F = Mounting, 2-pole
G = Mounting, 2-pole
W = Snap-in
X = Snap-in
Y = Snap-in
Z = Snap-in

**8130K20, 8140K20,
8140K21, 8140K22**

H = Mounting, 4-pole

Rocker/Paddle Color

M = White
T = Red
V = Black

Terminal Type

50 = Screw
51 = Solder lugs
52 = 0.250 in spade

Rocker/Paddle Style ⑥

All Except
**8130K20, 8140K20,
8140K21, 8140K22**

6 = 2-pole
7 = 2-pole
20 = 2-pole ⑦
37 = 2-pole ⑧

**8130K20, 8140K20,
8140K21, 8140K22**

14 = 4-pole

Notes

- ① These switches also have marked rating of 7A at 277 Vac and 3/4 hp at 277 Vac.
- ② Add code letters and numbers for mounting frame, rocker style and color and terminal construction.
- ③ Also rated 2A, 277 Vac; 2.5A, L125 Vac.
- ④ See Circuit Diagrams on **Page V11-T2-78**.
- ⑤ See Frame Styles on **Page V11-T2-59**.
- ⑥ See Rocker Styles on **Page V11-T2-61**.
- ⑦ Cannot be used with snap-in mounting bezel.
- ⑧ Recommended for use with snap-in mounting.



Sealed Rockette Switches

To determine complete catalog number, start with the appropriate base circuit number and add the appropriate code letters and/or numbers.

Catalog Number Selection

How To Order—Sealed Rockette Switches, Non-Illuminated

Example: **8055K23** → **E 2 V**

Rating	Poles and Throw	Circuit with Rocker in ...			Base Circuit Number			Circuit Number ①
		UP Position	CENTER Position	DOWN Position	Terminal Type			
					0.250 in Spade	Solder Lugs	Screw	
15A, 125 Vac 10A, 250 Vac 3/4 hp, 250 Vac	1PST	ON	NONE	OFF	8055K23	8055K24	8055K25	A
		ON	OFF	ON	8055K20	8055K21	8055K22	B
	ON	NONE	ON	8055K26	8055K27	8055K28	C	
	MOM. ON	OFF	MOM. ON	8055K29	8055K30	8055K31		D
15A, 125 Vac 10A, 250 Vac 3/4 hp, 250 Vac	1PDT	MOM. ON	OFF	MOM. ON	8055K32	8055K33	8055K34	A
		ON	NONE	OFF	8055K40	8055K41	8055K42	
	ON	OFF	ON	8055K46	8055K47	8055K48	C	
	MOM. ON	NONE	MOM. ON	8055K49	8055K50	8055K51		D
15A, 125 Vac 10A, 250 Vac 3/4 hp, 250 Vac	2PST	ON	NONE	OFF	8055K43	8055K44	8055K45	A
		ON	OFF	ON	8055K40	8055K41	8055K42	
	ON	NONE	ON	8055K46	8055K47	8055K48	C	
	MOM. ON	OFF	MOM. ON	8055K49	8055K50	8055K51		D
15A, 125 Vac 10A, 250 Vac 3/4 hp, 250 Vac	2PDT	MOM. ON	OFF	MOM. ON	8055K52	8055K53	8055K54	A
		ON	NONE	OFF	8055K40	8055K41	8055K42	
	ON	OFF	ON	8055K46	8055K47	8055K48	C	
	MOM. ON	NONE	MOM. ON	8055K49	8055K50	8055K51		D

Code letters and/or numbers. Add to base circuit number.

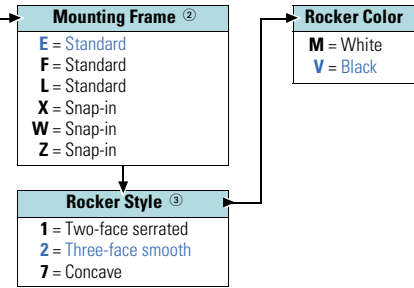

How To Order—Sealed Rockette Switches, Illuminated

Example: **8057K23** → **E 1 5 V 1**

Rating	Poles and Throw	Circuit with Rocker in ...			Base Circuit Number			Circuit Number ①
		UP Position	CENTER Position	DOWN Position	Terminal Type			
					0.250 in Spade	Solder Lugs	Screw	
15A, 125 Vac 10A, 250 Vac	1PST	ON	NONE	OFF	8057K23	8057K24	8057K25	G
	1PDT	MOM. ON	OFF	ON	8057K29	8057K30	8057K31	H

Code letters and/or numbers. Add to base circuit number.

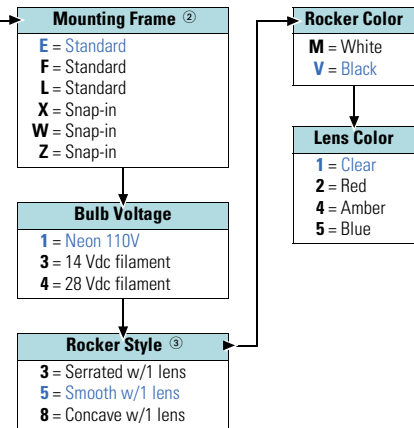

Notes

- ① See Circuit Diagrams on **Page V11-T2-78**.
- ② See Frame Styles on **Page V11-T2-59**.
- ③ See Rocker Styles on **Page V11-T2-61**.



8058 Series Sealed Rockette Switches

To determine complete catalog number, start with the appropriate base circuit number and add the appropriate code letters and/or numbers.

Catalog Number Selection

How To Order—Sealed Rockette Switches, Non-Illuminated

Example: **8058K28** → **Z 7 V**

Rating	Poles and Throw	Circuit with Rocker in ...			Base Circuit Number			Circuit Number ②
		UP Position	CENTER Position	DOWN Position	Terminal Type			
					0.250 in Spade	Solder Lugs	Screw ①	
30A, 125 Vac 25A, 250 Vac 3/4 hp, 125 Vac 2 hp, 250 Vac	1PST	ON	NONE	OFF	N/A	N/A	8058K10	A
	1PDT	ON	OFF	ON	N/A	N/A	8058K22	B
	1PDT	ON	NONE	ON	N/A	N/A	8058K28	B
	1PDT	MOM ON	OFF	ON	N/A	N/A	8058K31	B
	1PDT	MOM ON	OFF	MOM ON	N/A	N/A	8058K34	B

Code letters and/or numbers.
Add to base circuit number.

Mounting Frame ③

E = Standard ears up with two tapped holes
F = Standard flat with two holes
X = Metal snap-in
Z = Standard plastic snap-in
W = Contour plastic snap-in
L = Standard ears up with two holes

Rocker Color

M = White
T = Red
V = Black

Rocker Style ④

1 = Two-face serrated
2 = Three-face smooth
7 = Concave

8058K22E7V



8058K10X7T



8058K28Z7V



Notes

- ① Supplied with terminal screws, (Cat. No. 11-8616), unassembled.
- ② See Circuit Diagrams on **Page V11-T2-78**.
- ③ See Frame Styles on **Page V11-T2-59**.
- ④ See Rocker Styles on **Page V11-T2-61**.

Technical Data and Specifications

Rockette—General Purpose AC Rated

2

Description	Specification
Ratings and circuits	See selection tables on Pages V11-T2-55 to V11-T2-57 . Switch ratings at 125 Vac also apply to 28 Vdc.
Contact mechanism	Slow-make/slow-break contact mechanism. Butt action contact mechanism designed specifically for use on AC and low voltage DC applications
Contact material 3–6A rated	Movable—Silver-plated copper Stationary—Silver-plated copper
10–15A rated	Movable—Silver-plated copper with fine or coin silver contact face button Stationary—Copper with fine or coin silver contact face button
20A rated	Movable—Silver-plated copper with cad-oxide contact face button Stationary—Copper with cad-oxide contact face button

Description	Specification
1000W rated	Movable—Checon SK015B contact material welded to contactor Stationary—Copper with cad-oxide contact face button
Terminal types	Screw terminals—Brass designed to accept #6-32 x 3/16 binding head screws (Cat. No. 811-2), furnished unassembled Solder lug—0.250 in (6.35 mm) spade
Termination material	Screw and spade—Brass Solder—Tintillate-plated brass
Lamp voltages	110 Vac neon 14 Vdc and 28 Vdc
Mounting	Flush (two screws), sub-panel and snap-in mounting

Dimensions

Base Standard Rockette Switch Dimensions

Approximate Dimensions in Inches (mm)

Terminals

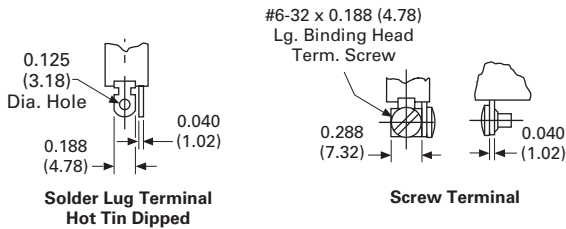

Snap-In Mounting Dimensions

Approximate Dimensions in Inches (mm)

Type W

Contoured Snap-In Bezel, Two-Pole Base

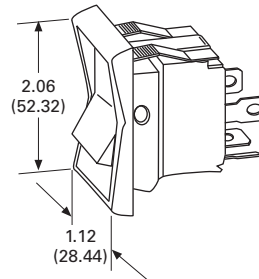

Type X

Snap-In Bezel, Single-, Two- and Four-Pole Bases

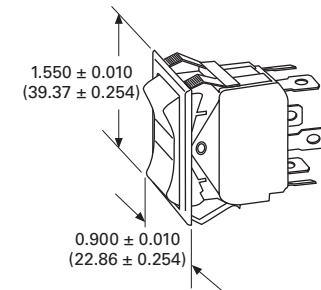

Type Y

Sub-Panel Snap-In Mounting Bezel, Single- and Two-Pole Bases

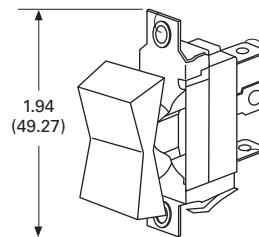

Type Z

Snap-In Mounting Bezel, Two-Pole Base Only

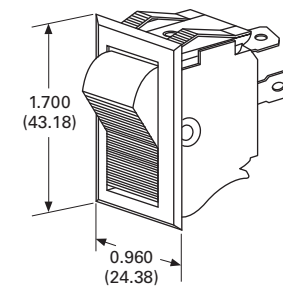

Panel Opening

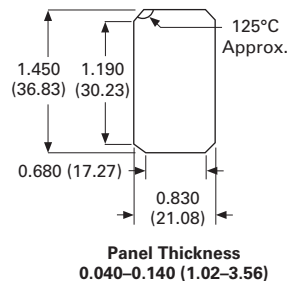

Frame Types and Rocker/Paddle Styles for Standing Switches—Non-Illuminated Dimensions

Approximate Dimensions in Inches (mm)

Two-Pole Mounting Frame Types

Type E

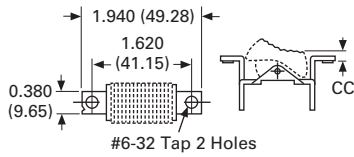

Type F

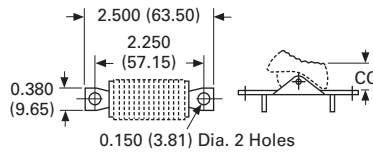

Style 37 with Type X

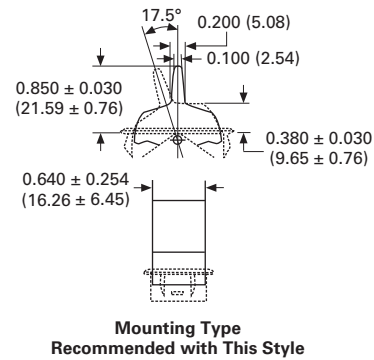

Type G

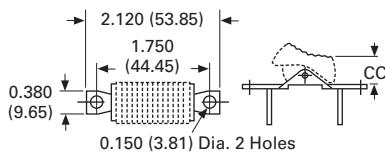

Two-Pole Rocker Styles

Style 6

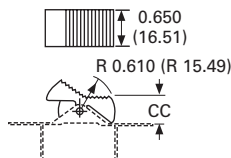

Style 7

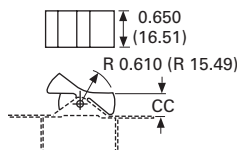

Style 20

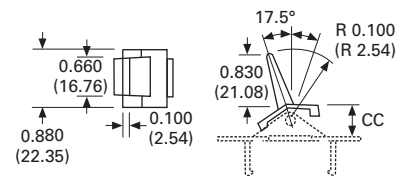

Four-Pole Mounting Frame Type

Type H

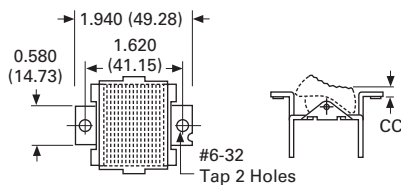

Four-Pole Rocker Styles

Style 14

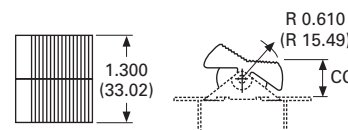

Reference Dimension "CC" — Top of Frame to Bottom of Terminal

Dimension in Inches (mm)				
Mounting Frame Type				
Two-Pole				
Rocker Style	Type E	Type F	Type G	Recommended Panel Opening
6	0.08 (2.03)	0.42 (10.67)	0.42 (10.67)	0.69 x 1.25 (17.53 x 31.75)
7	0.08 (2.03)	0.42 (10.67)	0.42 (10.67)	0.69 x 1.25 (17.53 x 31.75)
20	N/A	0.42 (10.67)	0.42 (10.67)	N/A
37	N/A	N/A	N/A	N/A

Dimension in Inches (mm)		
Mounting Frame Type		
Four-Pole		
Rocker Style	Type H	Recommended Panel Opening
14	0.08 (2.03)	1.34 x 1.25 (34.04 x 31.75)

Base Sealed Rockette Switch Dimensions

Approximate Dimensions in Inches (mm)

2 Sealed Two-Pole—Mounting Frame Type E—Rocker Style 1

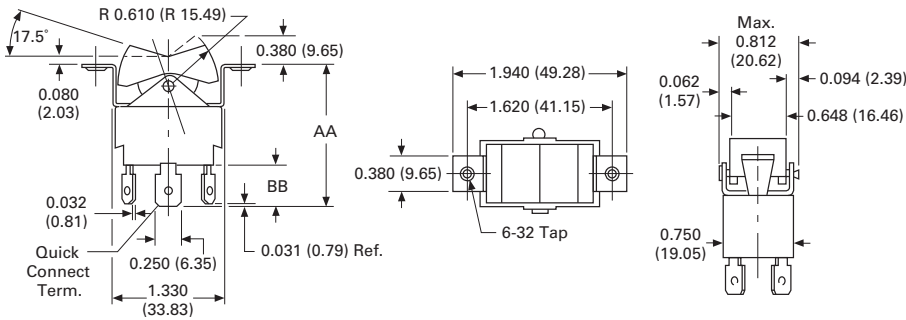

Terminals

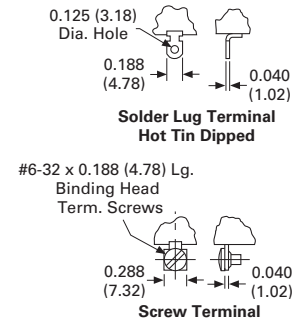

Sealed Two-Pole—Mounting Frame Type F—Rocker Style 1

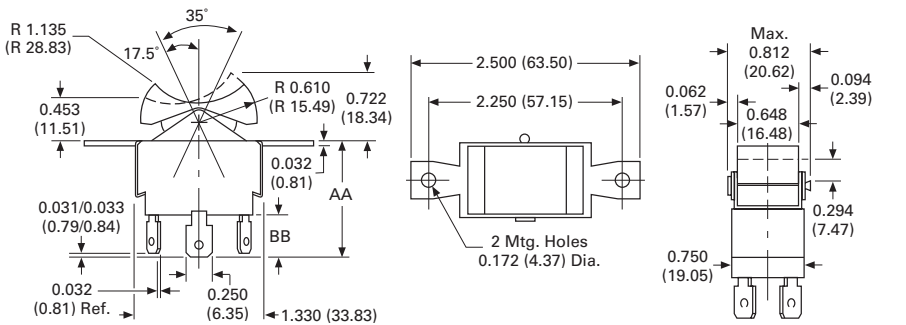

Panel Opening

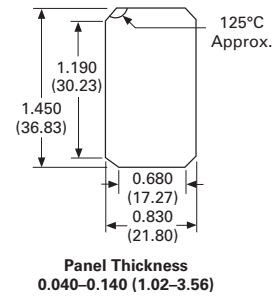

Snap-in Mounting Frame Dimensions

Approximate Dimensions in Inches (mm)

Sealed Two-Pole Switch—Mounting Frame Type W—Rocker Style 7

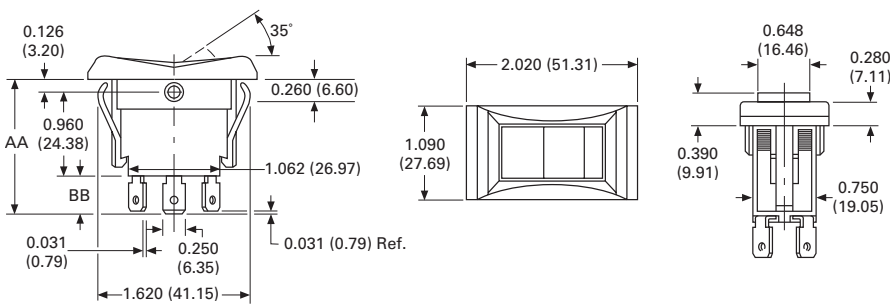

Terminals

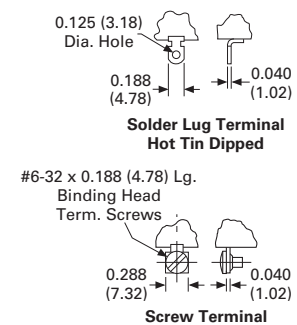

Type X

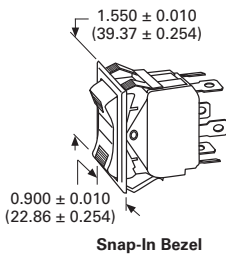

Type Z

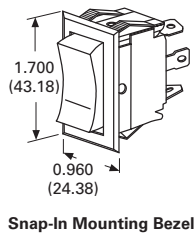

Reference Dimensions "AA" and "BB" in Inches (mm) ①

Terminal Type	Dimension "AA" (Two-Pole)						Dimension "BB"
	E Frame	F Frame	L Frame	W Frame	X Frame	Z Frame	All Frames
Screw	1.39 (35.33)	1.05 (26.62)	1.39 (35.33)	1.37 (34.82)	1.39 (35.34)	1.37 (34.82)	0.30 (7.62)
Solder lug	1.36 (34.57)	1.02 (25.86)	1.36 (34.57)	1.34 (34.06)	1.36 (34.51)	1.34 (34.06)	0.27 (6.86)
0.250 in spade	1.53 (38.89)	1.19 (30.18)	1.53 (38.89)	1.51 (38.38)	1.53 (38.89)	1.51 (38.38)	0.44 (11.18)
8058 Screw ②	1.509 (38.33)	1.145 (29.08)	1.509 (38.33)	1.808 (45.92)	1.627 (41.33)	1.528 (38.81)	0.460 (11.68)

Notes

- ① Dimension "AA"—Top of frame to bottom of terminal; "BB"—from bottom of base to bottom of terminal.
- ② #8-32 x 1/4 Phillips screw.

Dimensions for Frame Type and Rocker Styles—Sealed Switches

Approximate Dimensions in Inches (mm)

Non-Illuminated

Single- and Two-Pole Mounting Frame Types

Type E

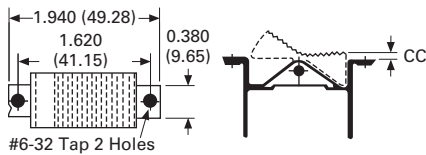

Type F

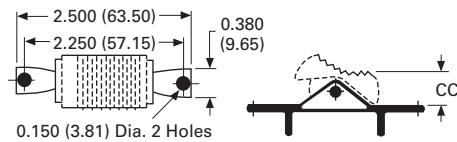

Type L

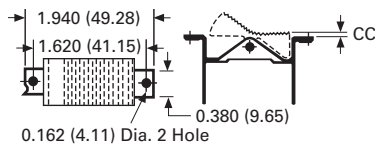

Single- and Two-Pole Rocker Styles

Style 1

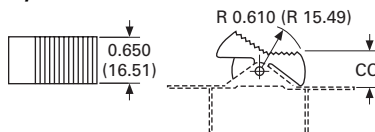

Style 2

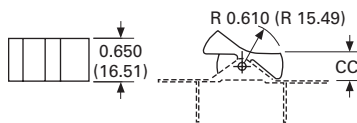

Style 7

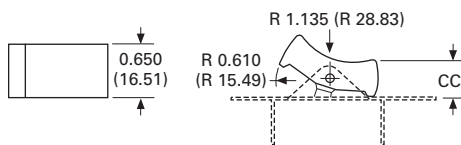

Reference Dimension "CC" — Top of Frame to Rocker Face

Rocker Style	Dimension in Inches (mm)			Recommended Panel Opening
	Mounting Frame Type			
	Single- and Two-Pole (Non-Illuminated)			
	E Frame	F Frame	L Frame	
1	0.08 (2.03)	0.42 (10.67)	0.08 (2.03)	0.69 x 1.25 (17.53 x 31.75)
2	0.08 (2.03)	0.42 (10.67)	0.08 (2.03)	0.69 x 1.25 (17.53 x 31.75)
7	0.11 (2.79)	0.45 (11.43)	0.11 (2.79)	0.69 x 1.25 (17.53 x 31.75)

Illuminated

Single-Pole Mounting Frame Types

Type E

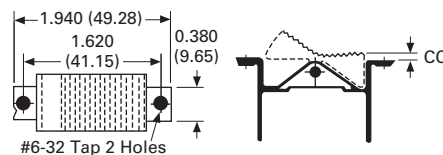

Type F

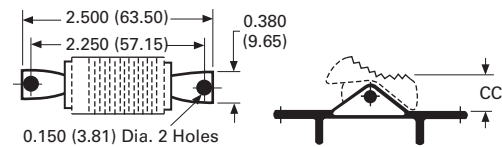

Type L

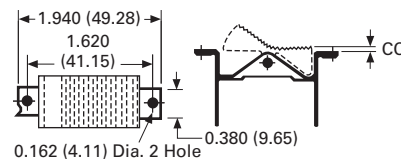

Single-Pole Rocker Styles

Style 3

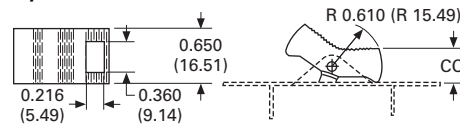

Style 5

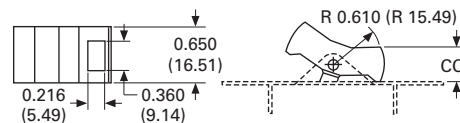

Style 8

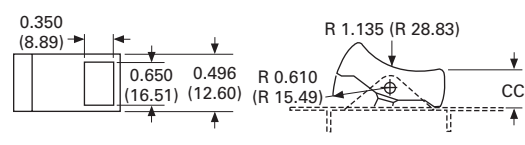

Rocker Style	Dimension in Inches (mm)			Recommended Panel Opening
	Mounting Frame Type			
	Single- and Two-Pole (Illuminated)			
	E Frame	F Frame	L Frame	
3	0.08 (2.03)	0.42 (10.67)	0.08 (2.03)	0.69 x 1.25 (17.53 x 31.75)
5	0.08 (2.03)	0.42 (10.67)	0.08 (2.03)	0.69 x 1.25 (17.53 x 31.75)
8	0.11 (2.79)	0.45 (11.43)	0.11 (2.79)	0.69 x 1.25 (17.53 x 31.75)

8006/8007 Series

2



Product Description

Field-proven in America's roughest off-road applications, the standard size EURO SR is one tough and reliable rocker switch. Available with the complete range of rugged single- and two-pole, illuminated or non-illuminated circuits.

The EURO SR Series offers snap-in mounting and can be provided with a durable silicone seal that resists dust and moisture.

All EURO SR switches are molded in an aesthetically pleasing matte finish and operate with a crisp tactile feel, allowing for easy actuation.

The EURO SR will accept loads up to 15A. Terminal numbers are stamped on base for easy identification.

Features and Benefits

- **Contact Mechanism**
Slow-make/slow-break contact mechanism. Butt action contact mechanism designed specifically for use on AC and low voltage DC applications.
- **Rocker Material**
Thermoplastic rocker actuators. Different colors are available. Rocker and bezel are a high-grade nylon supplied with matte finish.
- **Lamps**
Five lamp voltages—14 Vdc, 18 Vdc, 28 Vdc, 125 Vac neon and 250 Vac neon—are offered as standard. For additional lamp voltages, please contact your local Eaton Sales Representative.
- **Mounting Means**
Snap-in mounting with plastic bezel.
- **Seal**
Available in sealed and non-sealed versions. Sealed devices are furnished with silicone rubber seal, providing moisture and dust resistance with an IP67 rating.

Contents

Description	Page
8006/8007—EURO SR	
Catalog Number Selection	V11-T2-63
Technical Data and Specifications	V11-T2-64
Dimensions	V11-T2-64

Options

- Additional colors of rockers and bezels are available
- Special circuits
- Special ratings
- Pad-printed legends on rocker and bezel
- Special voltage bulbs
- Dry circuit capabilities
- Foam dust seal
- Reversing jumpers
- Printed circuit terminals and other terminal types
- Wire leads
- Dead back cover
- Palm guard
- Industry standard connector: 28-3426
- EURO SR panel plug: 53-3318

For information on optional features, contact your local Eaton Sales Representative.

Lens Options

- **Lens Part Numbers**
(if ordered separately)
- | | |
|-----------------|-----------|
| Green | 28-5415 |
| Amber | 28-5415-2 |
| Red | 28-5415-3 |
| Blue | 28-5415-4 |
| White | 28-5415-5 |

Standards and Certifications

- UL Recognized and recognized component for Canada File E2702
- RoHS Compliant ①



Note

① Visit www.eaton.com/vcbu for the most up-to-date list of verified part numbers.



EURO SR Standard Size Euro-Style Rocker Switches

To determine complete catalog number, start with the appropriate base circuit number and add the appropriate code letters and/or numbers.

Catalog Number Selection

How To Order—EURO SR, Non-Illuminated

Example: **8006K23** → **N 1 T 1**

Rating	Poles and Throw	Circuit with Rocker in ...			Terminal Type		
		UP Position	CENTER Position	DOWN Position	0.250 in Spade	Solder Lugs	Screw
10A, 250 Vac 15A, 125 Vac 15A, 28 Vdc	1PST	2-3	NONE	OFF	8006K23	8006K24	8006K25
		2-3 ①			8006K35	8006K36	8006K37
	1PDT	2-3	OFF	2-1	8006K20	8006K21	8006K22
		2-3 ①	NONE	2-1	8006K26	8006K27	8006K28
		2-3 ①	OFF	2-1 ①	8006K29	8006K30	8006K31
	2PST	2-3, 5-6	NONE	OFF	8006K43	8006K44	8006K45
		2-3, 5-6 ①			8006K55	8006K56	8006K57
	2PDT	2-3, 5-6	OFF	2-1, 5-4	8006K40	8006K41	8006K42
		2-3, 5-6 ①	NONE	2-1, 5-4	8006K46	8006K47	8006K48
		2-3, 5-6 ①	OFF	2-1, 5-4	8006K49	8006K50	8006K51
2-3, 5-6 ①		OFF	2-1, 5-4 ①	8006K52	8006K53	8006K54	
2PDT ②	2-3, 5-6	5-6	OFF	8006K58	8006K59	8006K60	
2PDT ③	5-6	5-3	5-1	8006K61	8006K62	8006K63	

Code letters and/or numbers. Add to base circuit number.

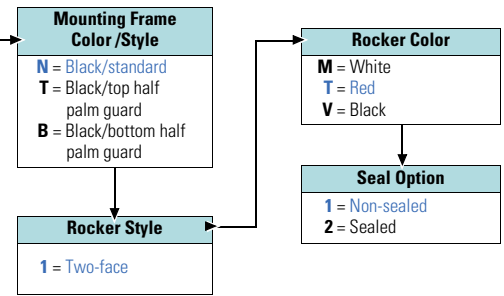

How To Order—EURO SR, Illuminated

Example: **8007K23** → **N 4 1 3 T 2 1**

Rating	Poles and Throw	Circuit with Rocker in ...			Terminal Type		
		UP Position	CENTER Position	DOWN Position	0.250 in Spade	Solder Lugs	Screw
10A, 250 Vac 15A, 125 Vac 15A, 28 Vdc	1PST	OFF	NONE	2-1	8007K23	8007K24	8007K25
		NONE	OFF	2-1 ①	8007K35	8007K36	8007K37
	1PDT ④	2-3	OFF	2-1	8007K20	8007K21	8007K22
		2-3 ①	NONE	2-1	8007K26	8007K27	8007K28
		2-3 ①	OFF	2-1	8007K29	8007K30	8007K31
		2-3 ①	OFF	2-1 ①	8007K32	8007K33	8007K34
	2PST	OFF	NONE	2-1, 5-4	8007K43	8007K44	8007K45
		2-3, 5-6 ①	OFF	NONE	8007K55	8007K56	8007K57
	2PDT ④⑤	2-3, 5-6	OFF	2-1, 5-4	8007K40	8007K41	8007K42
		2-1, 5-4	NONE	2-3, 5-6	8007K46	8007K47	8007K48
2-3, 5-6 ①		OFF	2-1, 5-4	8007K49	8007K50	8007K51	
2-3, 5-6 ①		OFF	2-1, 5-4 ①	8007K52	8007K53	8007K54	

Code letters and/or numbers. Add to base circuit number.

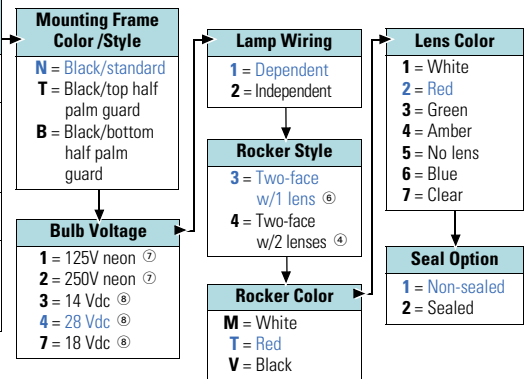

Notes

- ① Momentary contact.
- ② 3A at 250 Vac, 6A at 125 Vac.
- ③ 1/4 hp at 125–250 Vac.
- ④ All double-throw circuits, both 1PDT and 2PDT, provided with two lamps and two lenses (Rocker Style 4). When lamp is wired independent of circuit for 1PDT switches, device is supplied with lamp centered in open-pole of base.
- ⑤ Not standard with lamp wired independent of circuit. All 2PDT switches must be dependent on circuit and use Rocker Style 4.
- ⑥ Not provided standard for double-throw circuits, both 1PDT and 2PDT. Must use Rocker Style 4 for all double-throw switches.
- ⑦ Available on single-pole versions only.
- ⑧ 14 Vdc, 18 Vdc and 28 Vdc bulbs are not UL, CSA when bulb is wired dependent to switch circuit.

Technical Data and Specifications

8006/8007—EURO SR

2

Description	Specification
Ratings	15A at 125 Vac 10A at 250 Vac 3/4 hp at 250 Vac (hp rating does not apply to lighted switches) Switch ratings at 125 Vac also apply to 28 Vdc
Circuits	1PST, 1PDT, 2PST and 2PDT Maintained and momentary action
Mechanical life	Maintained—100,000 operations, minimum Momentary—25,000 operations, minimum
Electrical life	25,000 operations minimum at full load
Terminal types	Standard 0.250 in (6.35 mm) Spade—Brass Screw—Brass (terminal screws provided unassembled) Solder—Tintillate-plated brass
Base material	Thermoset molding material
Rocker material	Thermoplastic rocker actuators
Dielectric	1000V rms, minimum
Seal level	IP67 (with optional seal)
Mounting means	Snap-in mounting with plastic bezel
Operating temperature	−40° to 185°F (−40° to 85°C)

Dimensions

Approximate Dimensions in Inches (mm)

Non-Illuminated

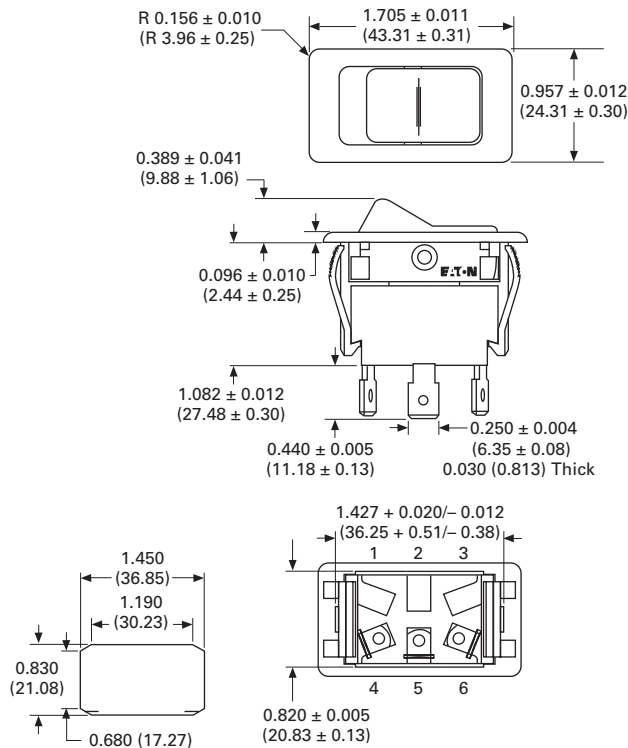

Panel Opening
Reference Only
Thickness:
0.040 to 0.140 (1.02 to 3.56)
Best Results Obtained from:
0.080 to 0.125 (2.03 to 3.18)

Illuminated

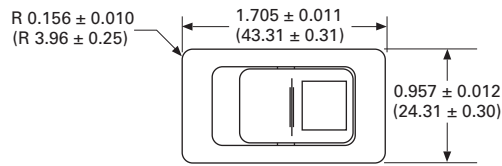

Palm Guard

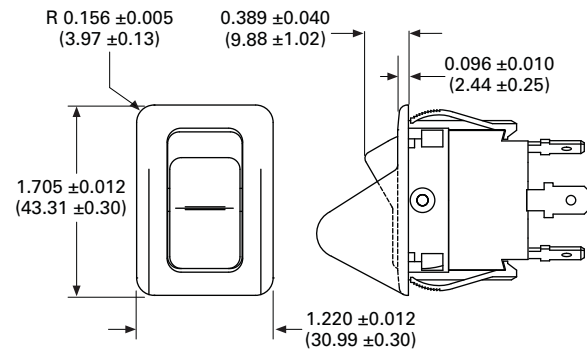

8004/8005—Euro Full Size



Contents

<i>Description</i>	<i>Page</i>
8004/8005—Euro Full Size	
Catalog Number Selection	V11-T2-66
Technical Data and Specifications	V11-T2-67
Dimensions	V11-T2-67

Product Description

Eaton’s 8004 and 8005 Euro-Look Series features matte finish European styling and snap-in mounting. These durable switches, field-tested in the most demanding truck and marine applications, are available with a variety of standard actuator options. Options include concave, two-face, illuminated, non-illuminated and the recessed feature, which allows placement of your label on the face of our rocker. All switches in this rugged lineup can be fitted with a silicone rubber seal to provide moisture and dust-resistance. Additionally, these switches can be gang-mounted into a single panel opening. Panel blanks are also available.

Features and Benefits

- **Contact Mechanism**
Slow-make/slow-break contact mechanism. Butt action contact mechanism designed specifically for use on AC and low voltage DC applications.
- **Rocker Material**
Custom styled, multi-colored thermoplastic rocker actuators. The rocker and bezel are supplied with a matte finish.
- **Lamps**
Five lamp voltages—14 Vdc, 18 Vdc, 28 Vdc, 125 Vac neon and 250 Vac neon—are offered as standard. For additional lamp voltages, please contact your local Eaton Sales Representative.
- **Mounting Means**
Snap-in mounting with plastic bezel.
- **Seal**
Available in sealed and non-sealed versions. Sealed devices are furnished with a silicone rubber seal providing moisture and dust resistance with an IP54 rating.

Options

- Additional colors of rockers and mounting bezels are available
 - Special circuits
 - Special ratings
 - Gold contacts
 - Dry circuit capabilities
 - Pad-printed legends on rocker and bezel
 - Special lamp voltages
 - Foam dust seal
 - Reversing jumpers
 - Printed circuit terminals and other terminal types
 - Dead back cover (two-pole base) with wire leads
 - Matching indicators
 - Industry standard connector: 28-3426
 - Full size Euro-Look gang mounting systems
 - Full size Euro-Look panel plugs: 17-19544-2
- For information on optional features, contact your local Eaton Sales Representative.

Lens Options

- **Lens Part Numbers** (if ordered separately)
 - 8005 Two-Face*
 - Green 28-3425
 - Amber 28-3425-2
 - Red 28-3425-3
 - Blue 28-3425-4
 - White 28-3425-5
 - 8005 Concave*
 - Red 28-5148
 - Green 28-5148-2
 - Amber 28-5148-3
 - Blue 28-5148-4
 - Clear 28-5148-5

Standards and Certifications

- UL Recognized and recognized component for Canada File E2702
- RoHS Compliant ①



Note

① Visit www.eaton.com/vc bu for the most up-to-date list of verified part numbers.



Full Size, Euro-Look Rocker Switches

To determine complete catalog number, start with the appropriate base circuit number and add the appropriate code letters and/or numbers.

Catalog Number Selection

How To Order—Full Size Euro, Non-Illuminated

Example: **8004K23** → **N 1 T 1**

Rating	Poles and Throw	Circuit with Rocker in ...			Terminal Type		
		UP Position	CENTER Position	DOWN Position	0.250 in Spade	Solder Lugs	Screw
10A, 250 Vac 15A, 125 Vac 15A, 28 Vdc	1PST	2-3 2-3 ①	NONE	OFF	8004K23 8004K35	8004K24 8004K36	8004K25 8004K37
		2-3 2-3 ① 2-3 ①	OFF NONE OFF	2-1 2-1 2-1 ①	8004K20 8004K26 8004K29	8004K21 8004K27 8004K30	8004K22 8004K28 8004K31
	2PST	2-3, 5-6 2-3, 5-6 ①	NONE	OFF	8004K43 8004K55	8004K44 8004K56	8004K45 8004K57
		2-3, 5-6 2-3, 5-6 2-3, 5-6 ① 2-3, 5-6 ①	OFF NONE OFF OFF	2-1, 5-4 2-1, 5-4 2-1, 5-4 2-1, 5-4 ①	8004K40 8004K46 8004K49 8004K52	8004K41 8004K47 8004K50 8004K53	8004K42 8004K48 8004K51 8004K54
	2PDT	2-3, 5-6 2-3, 5-6	5-6	OFF	8004K58 8004K61	8004K59 8004K62	8004K60 8004K63
		2-3, 5-6 2-3, 5-6 ①	5-3	OFF			

Code letters and/or numbers. Add to base circuit number.

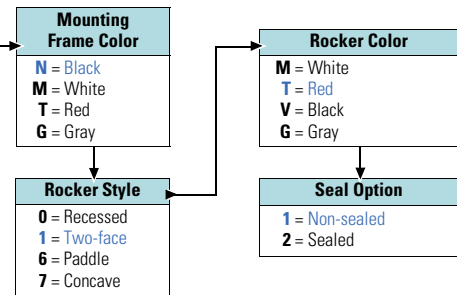

How To Order—Full Size Euro, Illuminated

Example: **8005K23** → **N 4 1 3 T 2 1**

Rating	Poles and Throw	Circuit with Rocker in ...			Terminal Type		
		UP Position	CENTER Position	DOWN Position	0.250 in Spade	Solder Lugs	Screw
10A, 250 Vac 15A, 125 Vac 15A, 28 Vdc	1PST	OFF NONE	NONE OFF	2-1 2-1 ①	8005K23 8005K35	8005K24 8005K36	8005K25 8005K37
		2-3 2-3 2-3 ① 2-3 ①	OFF NONE OFF OFF	2-1 2-1 2-1 2-1 ①	8005K20 8005K26 8005K29 8005K32	8005K21 8005K27 8005K30 8005K33	8005K22 8005K28 8005K31 8005K34
	2PST	OFF 2-3, 5-6 ①	NONE OFF	2-1, 5-4 NONE	8005K43 8005K55	8005K44 8005K56	8005K45 8005K57
		2-3, 5-6 2-1, 5-4 2-3, 5-6 ① 2-3, 5-6 ①	OFF NONE OFF OFF	2-1, 5-4 2-3, 5-6 2-1, 5-4 2-1, 5-4 ①	8005K40 8005K46 8005K49 8005K52	8005K41 8005K47 8005K50 8005K53	8005K42 8005K48 8005K51 8005K54

Code letters and/or numbers. Add to base circuit number.

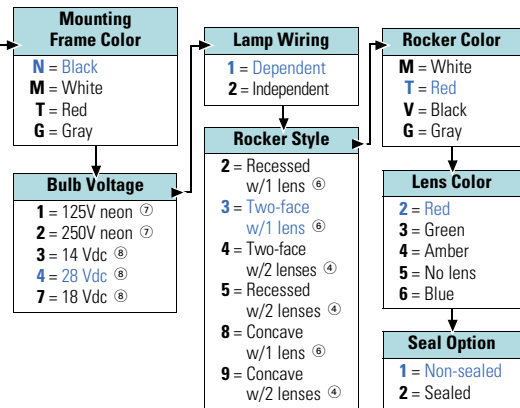

Notes

- ① Momentary contact.
- ② 3A at 250 Vac, 5A at 125 Vac.
- ③ 1/4 hp at 125–250 Vac.
- ④ All double-throw circuits, both 1PDT and 2PDT, provided with two lamps and two lenses (Rocker Style 4). When lamp is wired independent of circuit for 1PDT switches, device is supplied with lamp centered in open-pole of base.
- ⑤ Not standard available with lamp wired independent of circuit. All 2PDT switches must be dependent on circuit and use Rocker Style 4, 5 or 9.
- ⑥ Not provided standard for double-throw circuits, both 1PDT and 2PDT. Must use Rocker Style 4, 5 or 9 for all double-throw switches.
- ⑦ Available on single-pole versions only.
- ⑧ 14 Vdc and 28 Vdc bulbs are not UL, CSA when bulb is wired dependent to switch circuit.

Technical Data and Specifications

8004/8005—Euro Full Size

Description	Specification
Ratings	15A at 125 Vac; 10A at 250 Vac; 3/4 hp at 250 Vac (hp rating does not apply to lighted switches) Switch ratings at 125 Vac also apply to 28 Vdc
Circuits	1PST, 1PDT, 2PST and 2PDT; Maintained and momentary action
Contact material	Movable—Silver-plated copper with fine or coin silver contact face button Stationary—Copper with fine or coin silver contact face button
Mechanical life	Maintained—100,000 operations, minimum Momentary—25,000 operations, minimum
Electrical life	25,000 operations minimum at full load
Terminal types	Standard 0.250 in (6.35 mm) spade—Brass Screw—Brass #6-32 x 3/16 (terminal screws provided unassembled) Solder—Tintillate-plated brass; tintillate spade terminals
Base material	Thermoset molding material
Dielectric	1000V rms, minimum
Seal level	IP54 (with optional seal)
Mounting means	Snap-in mounting with plastic bezel

Dimensions

Approximate Dimensions in Inches (mm)

Non-Illuminated

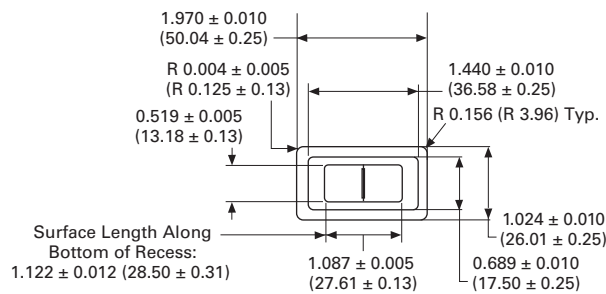

Illuminated

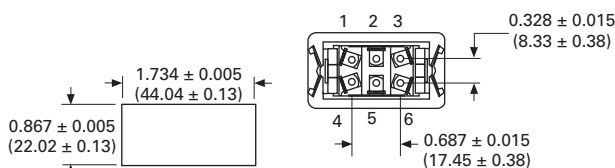
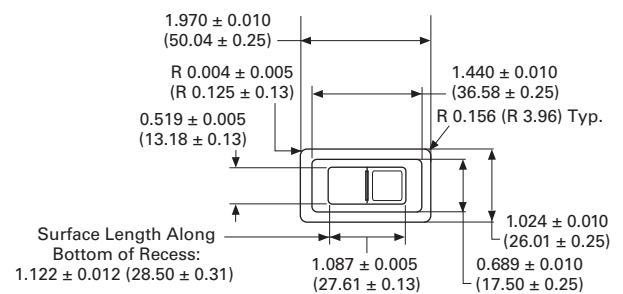

Panel Opening
 Reference Only
 Thickness:
 0.030 to 0.190 (0.76 to 4.83)
 Best Results Obtained From:
 0.080 to 0.130 (2.03 to 3.30)

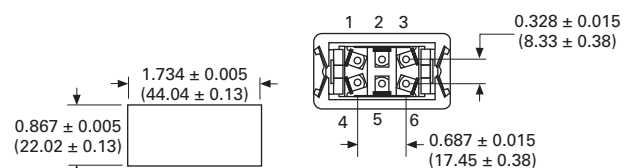

Panel Opening
 Reference Only
 Thickness:
 0.030 to 0.190 (0.76 to 4.83)
 Best Results Obtained From:
 0.080 to 0.130 (2.03 to 3.30)

X Series Rockers—XR

2



Contents

Description

Page

X Series Rockers	
Catalog Number Selection	V11-T2-69
X Series Symbols Library	V11-T2-70
Technical Data and Specifications	V11-T2-70
Light Diagrams	V11-T2-70
Dimensions	V11-T2-71

Product Description

The Electrical Sector is pleased to offer X Series Rockers for use in outdoor applications to meet almost every market need.

These sleek style rockers are molded in a unique smooth matte finish. The bezel is also unique with a more modern rounded-rectangular design with an oval shaped rocker. X Series Rockers are available in single- and double-pole with various circuit options, LED illumination, and laser etching.

- Frames and actuator colors are black
- Switches provided with 0.025 spade quick connect terminals

Application Description

Market Applications

- Agriculture
- Bus
- Commercial
- Marine
- Specialty Vehicle
- Truck

Features and Benefits

- Seal
Standard IP56 Sealing per IES 60529.
- Illumination
Standard LED voltages offered include 14 Vdc and 125 Vac.
- Material
Frames are nylon and actuators are nylon with glass fiber with both meeting UL flame: 94HB. Terminals are silver plated brass.
- Mounting Means
Easy snap-in mounting with plastic bezel.
- Label
Eaton part number etched on switch for easy inventory management.

Options

- Panel plug: 53-3318
- Industry standard connector: 28-3426
- For information on optional features, contact your local Eaton Sales Representative.

Standards and Certifications

- UL Recognized and recognized component for Canada File E2702
- T85
- RoHS Compliant

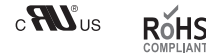

Product Selection Guide

Seal	Actuator	Decorative	Termination	Illumination	
Top ✓	Rocker without bezel —	Laser-etch ✓	Spade ✓	Incandescent 6 Vdc —	Neon 110V —
Bottom —	Rocker with bezel ✓	Pad-print —	Solder —	Incandescent 12 Vdc —	Neon 125V —
Panel —	Paddle —		Screw —	Incandescent 14 Vdc —	Neon 250V —
	Snap-in lens —	Poles	Weld lugs —	Incandescent 18 Vdc —	14 Vdc LED ✓
	Locking —	Single ✓		Incandescent 24 Vdc —	28 Vdc LED —
	Label —	Double ✓		Incandescent 28 Vdc —	125 Vac LED ✓
		Four —			277 Vac LED —



X Series Rockers

Catalog Number Selection

Standard rating 16A 125V, 10A 277V, 3/4 hp 277V
Also recommended for use in applications up to 21A 14 Vdc
IP56 per IES 60529

Product Selection

XR Series Rocker



X Series Rockers

Lamp Voltage	Switch Function	Light Circuit ^③	Lens Color T. 1-4	T. 3-6	Switch Markings	Catalog Number
None	SPST OFF-ON	X = None	None	None	Int'1 ON/OFF ^④	XRAXXXNV1CU
	SPST OFF-ON	X = None	None	None	ON/OFF ^④	XRAXXXNV1DB
14 Vdc LED	SPST OFF-ON	E =	None	Amber	None	XR1AEX4NV1XX
	SPST OFF-ON	E =	None	Green	None	XR1AEX3NV1XX
	SPST OFF-ON	E =	None	Red	None	XR1AEX2NV1XX
	SPDT ON-ON	G =	Amber	Amber	None	XR1CG44NV1XX
	SPDT ON-ON	G =	Green	Green	None	XR1CG33NV1XX
	SPDT ON-OFF-ON	G =	Amber	Amber	None	XR1BG44NV1XX
	SPDT ON-OFF-ON	G =	Green	Green	None	XR1BG33NV1XX
	SPDT (ON)-OFF-(ON)	G =	Amber	Amber	None	XR1EG44NV1XX
	SPDT (ON)-OFF-(ON)	G =	Green	Green	None	XR1EG33NV1XX
None	DPST OFF-ON ^②	X = None	None	None	Int'1 ON/OFF ^④	XRXXXXNV1CU
	DPST OFF-ON ^②	X = None	None	None	ON/OFF ^④	XRXXXXNV1DB
	DPST OFF-ON	X = None	None	None	None	XRXXXXNV1XX
	DPST ON-ON	X = None	None	None	None	XRXXXXNV1XX
125 Vac LED ^①	SPST OFF-ON	E =	None	Amber	None	XR3AEX4NV1XX
	SPST OFF-ON	E =	None	Green	None	XR3AEX3NV1XX
	SPST OFF-ON	E =	None	Red	None	XR3AEX2NV1XX
	SPDT ON-ON	G =	Amber	Amber	None	XR3CG44NV1XX
	SPDT ON-ON	G =	Green	Green	None	XR3CG33NV1XX
	SPDT ON-OFF-ON	G =	Amber	Amber	None	XR3BG44NV1XX
	SPDT ON-OFF-ON	G =	Green	Green	None	XR3BG33NV1XX
	SPDT (ON)-OFF-(ON)	G =	Amber	Amber	None	XR3EG44NV1XX
	SPDT (ON)-OFF-(ON)	G =	Green	Green	None	XR3EG33NV1XX

Notes

- ① Available in AC applications only.
- ② Double-pole not available illuminated; it is available laser etched.
- ③ See Circuit Diagrams on **Page V11-T2-70**.
- ④ See Symbols Library on **Page V11-T2-70**.

X Series Symbols Library

2

Inscription	Catalog Number Suffix	Inscription	Catalog Number Suffix
— ○	CU	ON OFF	DB

Technical Data and Specifications

X Series

Description	Specification
Ratings	16A 125V, 10A 277V, 3/4 hp 277V; recommended 21A 14 Vdc or 10A 28 Vdc
Operating temperature	−4° to 176°F (−20° to 80°C)

Light Diagrams

X Series

Light Circuit Letter	Functions	Light Circuit Letter	Functions	Light Circuit Letter	Functions
X	All	E	SPST	G	SPDT
1 ● ● 4 2 ● ● 5 3 ● ● 6					
			Jumpers (3–4)		

Dimensions

Approximate Dimensions in Inches (mm)

Mounting Hole

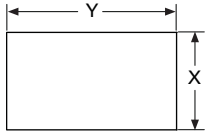

Dimensions

Thickness	0.03–0.12 (0.75–3.0)
X	0.83 +0.01 (21.2 +0.1)
Y	1.46 + 0.01 (37.0 +0.1)

X Series

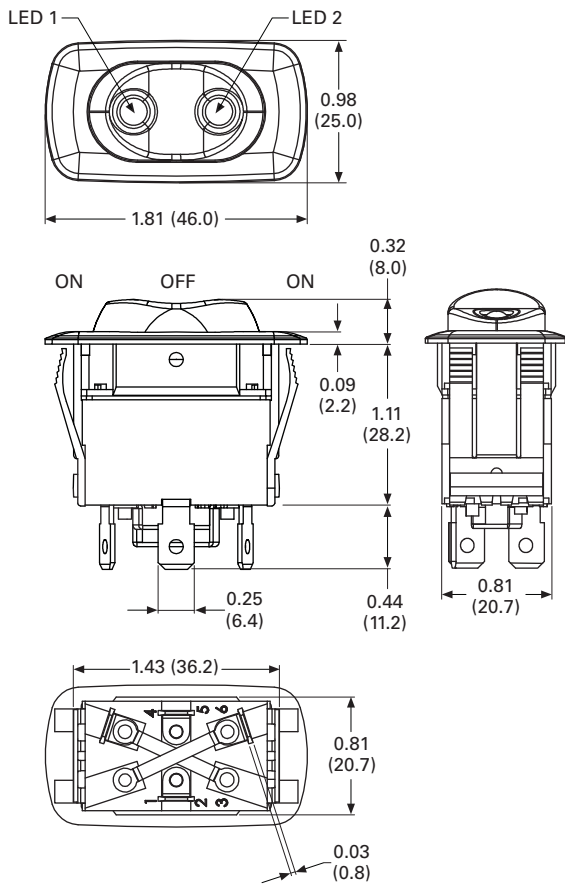

8064/8065 Series

2



Product Description

The ergonomically designed ESPORT Series comes with a large, independent LED-illuminated indicator window that clearly identifies the switch's labeled function—your label or ours. The switch can be ordered with an LED illuminated actuator, as well. All ESPORT switches are molded in a clean matte finish and operate with a definite tactile feel. Actuation of the switch feels crisp. Also, ESPORT switches will accept loads up to 15A. Due to the LED's long life, lamp replacement should not be necessary.

Tested in America's toughest truck applications, the ESPORT switch is reliable and durable and is available with a full range of rugged single- and two-pole circuits. It has an optional polarized lock-on connector. Spade switch terminals are tin-plated for long storage life.

Features and Benefits

- **Contact Mechanism**
Slow-make/slow-break contact mechanism. Butt action contact mechanism designed specifically for use on AC and low voltage DC applications.
- **Rocker Material**
Thermoplastic rocker actuators. Different colors are available. The rocker and the bezel are a high-grade nylon and are supplied with an aesthetically pleasing matte finish.
- **Lamps**
Durable, long-life LED illumination; 14 Vdc is standard. Integral indicator is illuminated by two independent green, yellow or red LEDs while the actuator is lighted using one dependent LED. For additional LED voltages and/or colors, contact your local Eaton Sales Representative.
- **Mounting Means**
Snap-in mounting with plastic bezel.

Contents

Description	Page
8064/8065—ESPORT	
Catalog Number Selection	V11-T2-73
Technical Data and Specifications	V11-T2-74
Icon/Legend Selection	V11-T2-74
Dimensions	V11-T2-75

Options

- Additional colors of rockers and mounting bezels are available
 - Special circuits
 - Special ratings
 - Dry circuit capabilities
 - Pad-printed legends on lens, rocker and bezel
 - Special indicator legend labels
 - Special LEDs and LED voltages
 - Special actuators
 - Reversing jumpers
 - Solder terminals and other terminal types
 - Wire leads
 - Polarized lock-on connector: 28-5558
 - Full-size Euro-Look panel plugs: 17-19544-2
- For information on optional features, contact your local Eaton Sales Representative.

Standards and Certifications

- UL Recognized and recognized component for Canada: File 2702
- RoHS Compliant ①



Note

① Visit www.eaton.com/vcbu for the most up-to-date list of verified part numbers.



ESPORT Full-Size Rocker Switches

To determine complete catalog number, start with the appropriate base circuit number and add the appropriate code letters and/or numbers.

Catalog Number Selection

How To Order—ESPORT, Non-Illuminated

Example: **8064K10** → **L R Z 1 W 2**

Rating	Poles and Throw	Circuit with Rocker in ...			Base Circuit Number
		UP Position	CENTER Position	DOWN Position	
15A, 125 Vac 15A, 28 Vdc	1PST	5-6	NONE	OFF	8064K10
		OFF	NONE	5-4	8064K11
	1PDT	2-3	OFF	2-1	8064K14
		2-3	NONE	2-1	8064K12
		2-3 ①	OFF	2-1	8064K17
		2-3 ①	OFF	2-1 ①	8064K16
	2PST	2-3, 5-6	NONE	OFF	8064K20
		OFF	NONE	2-1, 5-4 ①	8064K21
	2PDT	2-3, 5-6	OFF	2-1, 5-4	8064K24
		2-3, 5-6	NONE	2-1, 5-4	8064K22
		2-3, 5-6 ①	OFF	2-1, 5-4	8064K27
		2-3, 5-6 ①	OFF	2-1, 5-4	8064K26

Code letters and/or numbers.
Add to base circuit number.

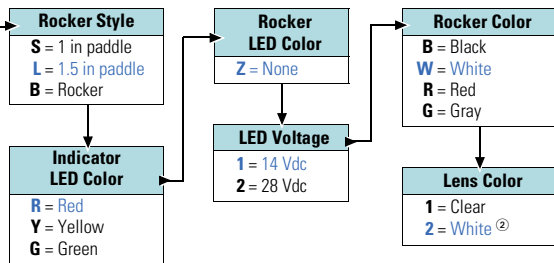

How To Order—ESPORT, Illuminated

Example: **8065K10** → **S R Y 1 W 2**

Rating	Poles and Throw	Circuit with Rocker in ...			Base Circuit Number
		UP Position	CENTER Position	DOWN Position	
15A, 125 Vac 15A, 28 Vdc	1PST	5-6	NONE	OFF	8065K10

Code letters and/or numbers.
Add to base circuit number.

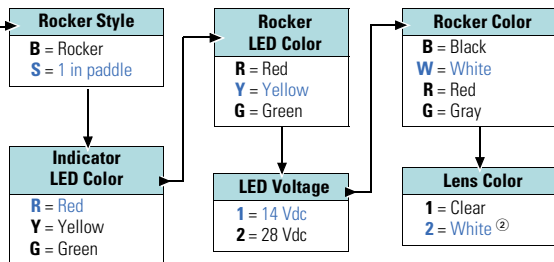

Notes

- ① Momentary contact.
- ② White lenses are furnished unassembled.

Technical Data and Specifications

8064/8065—ESPORT





2

Description	Specification
Ratings	15A at 125 Vac; 10A at 250 Vac; 3/4 hp at 250 Vac Switch ratings at 125 Vac also apply to 28 Vdc
Circuits	1PST, 1PDT, 2PST and 2PDT Maintained and momentary action
Contact material	Movable—Silver-plated copper with silver contact face button Stationary—Copper with silver contact face button
Mechanical life	Maintained—100,000 operations, minimum Momentary—25,000 operations, minimum
Terminal types	Switch—Standard 0.250 in (6.35 mm) spade, tinned-plated brass Integral indicator—0.110 x 0.032 in (2.79 x 0.813 mm) spade, tinned-plated brass
Base material	Thermoset molding material
Dielectric	1000V rms, minimum
Mounting means	Snap-in mounting with plastic bezel

Icon/Legend Selection

- All labels below come with adhesive backing
- Label legends are distinct and easily readable when illuminated from behind
- Additional labels are available upon request. Contact your local Eaton Sales Representative

Icons and Legends

Legend	Style	Ordering Code ^①	Icon	Description	Ordering Code ^①
Dome Light		0055		Windshield Wiper SAE Specification No. J1362-0086 White graphic on a black background	0057
Work Light		0056			
TV/VCR		0065			
Fridge		0066		Windshield Washer SAE Specification No. J1362-0087 White graphic on a black background	0986
Cruise ON/OFF		0067			
Brake Select	Helvetica Narrow	0068			
Brake ON/OFF	0.135 in (3.43 mm) high White translucent letters	0069		Master Lighting Switch SAE Specification No. J1362-5012 White graphic on a black background	0687
Fan Override	Opaque black background	0071			
Cruise Set		0681			
Engine Brake		0682		Fog Lights SAE Specification No. J1362-0633 White graphic on a black background	0684
Left Window		0683			
Power Mirror		0688		Clearance/Position Light SAE Specification No. J1362-0456 White graphics on a black background	0686
Right Window		0689			

Note

- ^① Ordering Code: If a standard label is required, add the Ordering Code to the end of ESPORT Switch part number preceded by a dash. Example: To order 8065K10BYR1B1 with the 0684 Fog Lights label, the part number will be 8065K10BYR1B1-0684.

Dimensions

Approximate Dimensions in Inches (mm)

Non-Illuminated and Illuminated

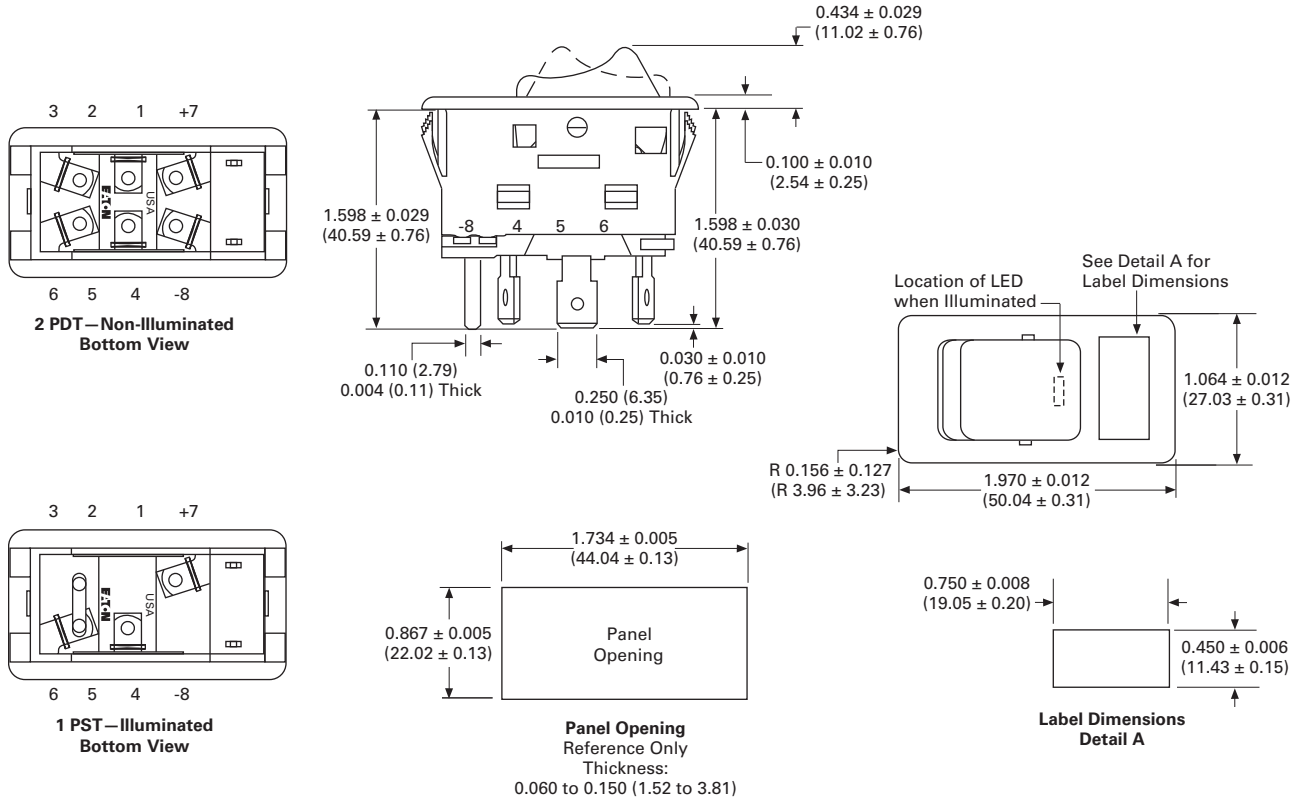

Dimensions for NGR, EURO SR, Full Size Euro-Look and ESPORT Rocker Accessories

Approximate Dimensions in Inches (mm)

2

NGR Connector

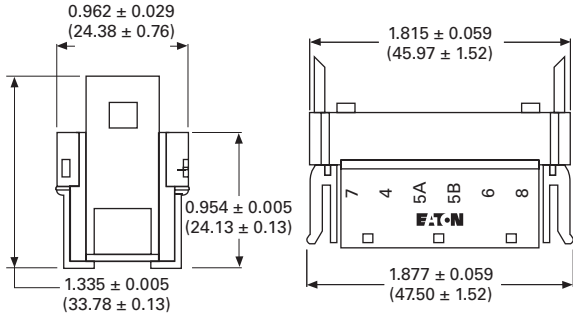

NGR Connector Catalog Number **28-5637-2** accepts Packard 12015870 Metri-Pack terminals or AMP compatible connector **28-5940** accepts AMP terminals 42100-2.

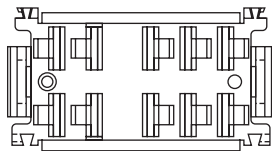

Euro/SR and Full Size Euro-Look Connector

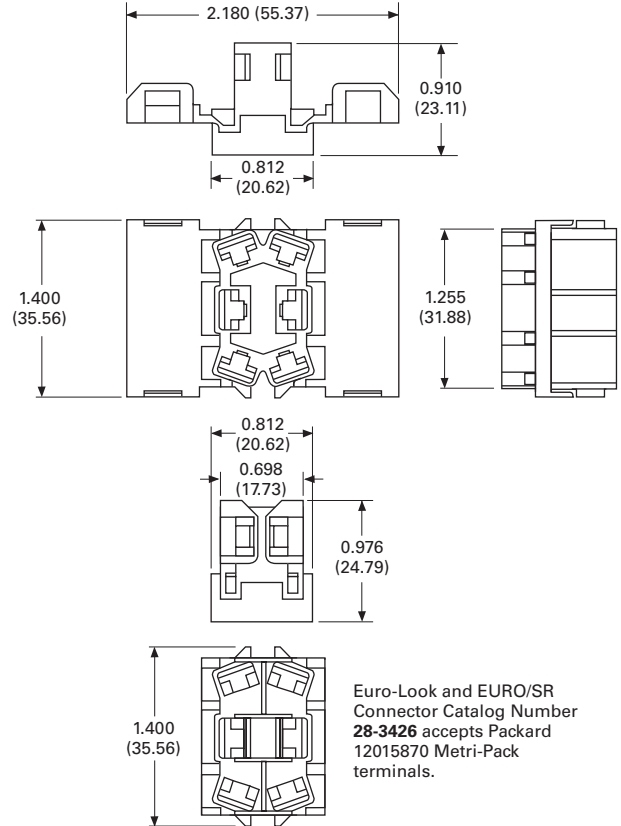

Euro-Look and EURO/SR Connector Catalog Number **28-3426** accepts Packard 12015870 Metri-Pack terminals.

ESPORT Connector

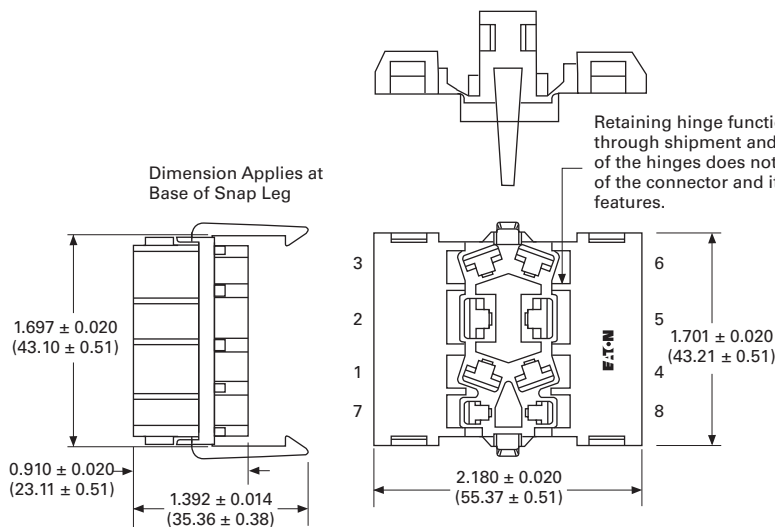

ESPORT Connector Catalog Number **28-5558**
 Locations 1, 2, 3, 4, 5 and 6 accept Packard 12015870 Metri-Pack terminals.
 Locations 7 and 8 accept Packard 12034046 Metri-Pack terminals.

Approximate Dimensions in Inches (mm)

Gang Mounting System

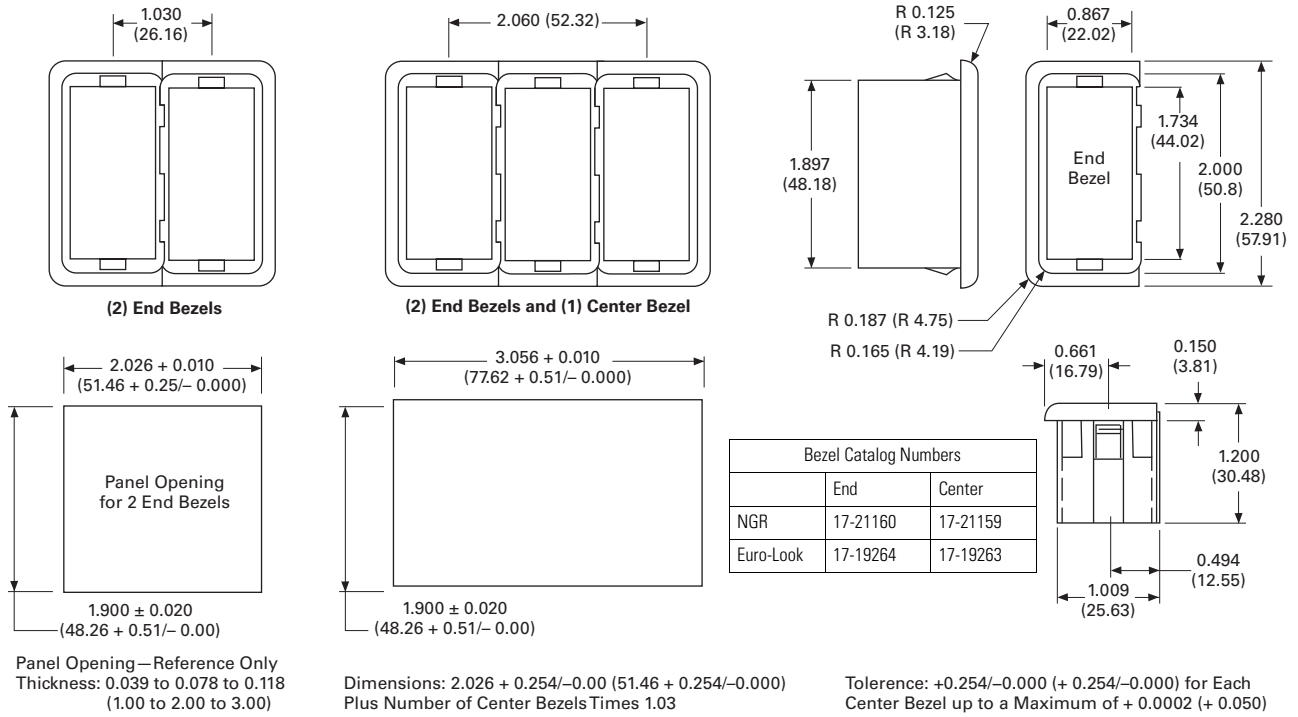

NGR, Euro-Look and ESPORT Panel Plugs

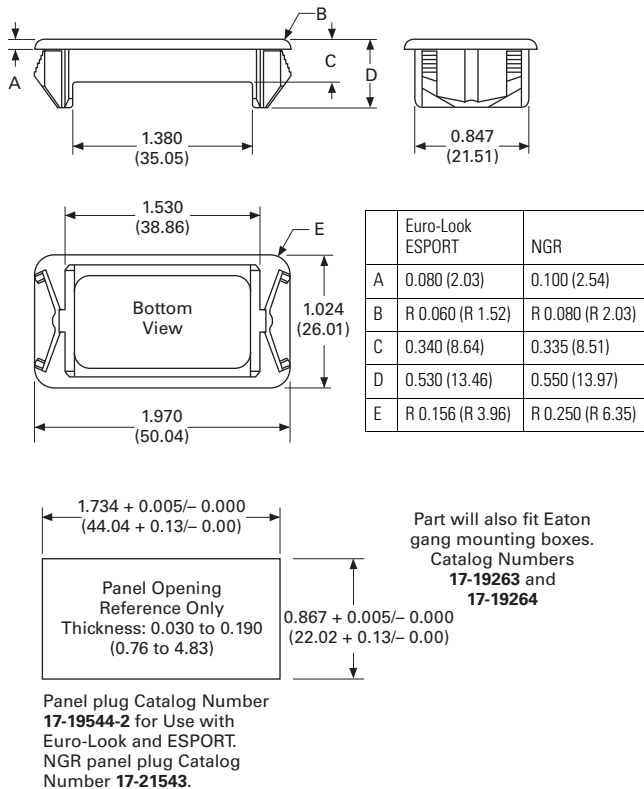

EURO SR Panel Plugs

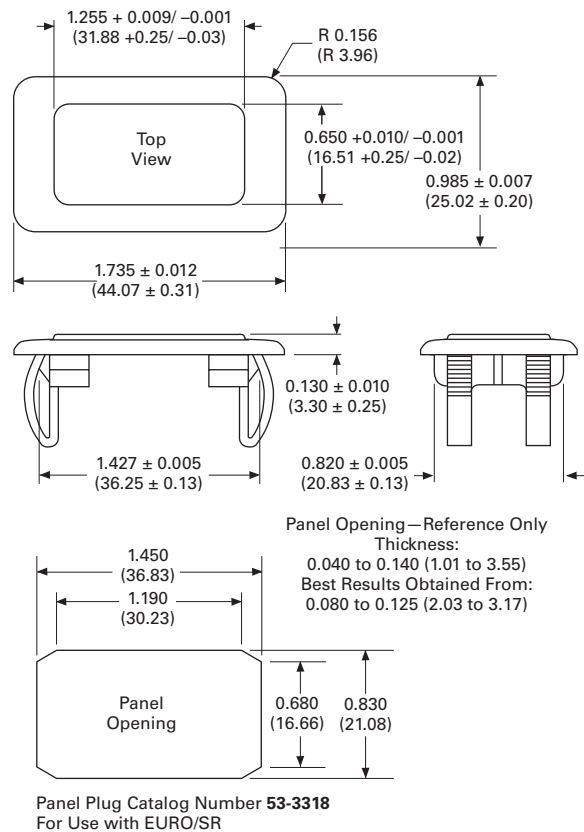

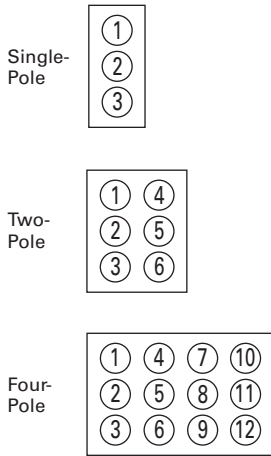

Terminal Identification

When specified on order, switches will have the terminals identified as shown in the illustration at right. Terminal markings will be ink-stamped on the side of the switch case and unused terminal positions will not be identified.

All views are rear of switch with keyway or at down as applicable. Terminal numbers 2, 2 and 5 and 5 and 8 are considered inboard terminals for single-, two- and four-pole switches respectively. All others are considered outboard.

“Three Independent” ON-ON-ON Circuit Diagram

For switch modified with “Three Independent” ON-ON-ON special circuit. External jumpers are required. User to connect wiring per instructions given below.

ON-ON-ON Special Circuit

Connection Points	Single-Pole
Connect common to terminals	2
Connect circuit “A” to terminals	6
Connect circuit “B” to terminals	4
Connect circuit “C” to terminals	1

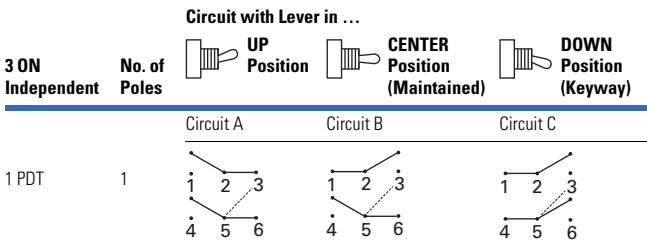

Circuit Diagrams

Rocker Circuit Diagrams

Circuit Letter	Schematic	Circuit Letter	Schematic
A 1PST		I 2 Circuit ^⑤	
B 1PDT		J 1PST	
C 2PST		K 1PDT	
D 2PDT		L 2PST	
E 4PST ^①		M 2PST	
F 4PDT ^②		N ^⑥ 2PDT	
G ^③ 1PST		P 1PDT	
H ^④ 1PDT		Q ^⑦ 2 Circuit	

Legends

Rocker Switch Legend

Legend	Rocker Switch Type
●	Contact terminal—will make contact with switch lever
○	Isolated terminal—does not make contact with lever
⌋	Center terminal and switch lever
⊗	Bulb
⤴	Momentary contact
●	Denotes mechanical contact portion

See next page for Midsize Switch Circuit Diagrams. See **Page V11-T2-17** for NGR Circuit Diagrams.

Notes

- ① Poles 11 and 12 may be eliminated for three-pole devices.
- ② Poles 10, 11 and 12 may be eliminated for three-pole devices.
- ③ Dependent lamp.
- ④ Independent lamp.
- ⑤ Two circuit—indicates a special type of double-throw switch in which the two circuits being controlled may be independent of each other.
- ⑥ For 206 Series, an additional lamp is available.
- ⑦ Available in 1PDT or 2PDT.

Midsize Switch Circuit Diagrams ^①

Non-Illuminated

Circuit Number (Circuit Designator)	Schematic	Circuit with Rocker In ...		
		DOWN Position	CENTER Position	UP Position
1 1PST		OFF	NONE	ON
2 1PST		OFF	NONE	ON
3 1PST		OFF	NONE	MOM. ON
4 1PST		OFF	NONE	ON
5 1PDT		ON	NONE	ON
6 1PDT		ON	OFF	ON
7 1PDT		MOM. ON	NONE	ON
8 1PDT		ON	OFF	MOM. ON
9 1PDT		MOM. ON	OFF	MOM. ON
10 2PST		OFF	NONE	ON
11 2PST		OFF	NONE	MOM. ON
12 2PST		MOM. OFF	NONE	ON
13 2PDT		ON	NONE	ON
14 2PDT		ON	OFF	ON
15 2PDT		MOM. ON	NONE	ON
16 2PDT		ON	OFF	MOM. ON
17 2PDT		MOM. ON	OFF	MOM. ON

Illuminated





































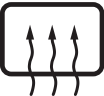







Circuit Number (Circuit Designator)	Schematic	Circuit with Rocker In ...		
		DOWN Position	CENTER Position	UP Position
18 1PST		OFF	NONE	ON
19 1PST		OFF	NONE	ON
20 1PST ^②		OFF	NONE	ON
21 1PST		OFF	NONE	MOM. ON
22 1PDT		MOM. OFF	NONE	ON
23 1PDT		ON	NONE	ON
24 1PDT		ON	OFF	ON
25 1PDT		MOM. ON	NONE	ON
26 1PDT		ON	OFF	ON
27 2PST		ON	OFF	ON
28 2PST		ON	NONE	ON
29 2PST ^③		ON	NONE	ON
30 2PDT		MOM. ON	NONE	MOM. ON
31 2PDT		ON	NONE	ON
32 Indicator		—	—	—

Notes

- ① Terminal numbers 1, 2 and 3 denote single-pole base.
Terminal numbers 11, 12, 113, 24, 25 and 26 denote two-pole base.
- ② Single-pole in two-pole base with lamp independently wired.
- ③ Two-pole—independently wired lamp.

NGR, SVR, E31, E32 and E33 eSM Symbols ^{①②}

2

Inscription	Catalog Number Suffix	Inscription	Catalog Number Suffix	Inscription	Catalog Number Suffix	Inscription	Catalog Number Suffix
	AA		AQ		BF		BU
	AB		AR		BG		BV
	AC		AS		BH		BW
	AD		AT		BI		BX
	AE		AU		BJ	OVER RIDE	BY
	AF		AV		BK		BZ
	AG		AW		BL		CA
	AH		AX		BM	(M)	CB
	AJ		AY		BN	(M) ¹ (M) ² (M) ³	CC
	AK		BA	3	BP	(M) ¹ (M) ²	CD
	AL		BB	1	BQ		CE
	AM		BC		BR		CF
	AN		BD		BS	DIAGNOSTIC SEO	CG
	AP		BE		BT	CR	CH

① Additional icons are available. Contact your local Eaton Sales Representative.

② SAE Specification No. J1362.















































NGR, SVR, E31, E32 and E33 eSM Symbols ①②

Inscription	Catalog Number Suffix	Inscription	Catalog Number Suffix	Inscription	Catalog Number Suffix	Inscription	Catalog Number Suffix
SET/COAST RES/ACCEL	CI		CX		DN		EC
REGLER/ ROUE LIBRE	CJ		CY		DP		ED
AJUSTAR	CK		DA		DQ		EE
CRUISE	CL		DB		DR	SET	EF
REPRENDRE/ ACCEL	CM		DC		DS	RESUME	EG
VOLVERA VELOCIDAD	CN		DD		DT	ETHER	EH
	CP		DE		DU		EI
	CQ		DF		DV		EJ
	CR		DG		DW		EK
	CS		DH	START	DX		EL
	CT		DJ	STOP	DY		EM
	CU		DK		DZ		EN
	CV		DL		EA	B/U CAMERA	EO
	CW		DM		EB		EP

① Additional icons are available. Contact your local Eaton Sales Representative.

② SAE Specification No. J1362.

NGR, SVR, E31, E32 and E33 eSM Symbols ^{①②}

Inscription	Catalog Number Suffix	Inscription	Catalog Number Suffix	Inscription	Catalog Number Suffix	Inscription	Catalog Number Suffix
	EQ		FE		FS	MICRO WAVE	GG
	ER		FF		FT		GH
WC	ES		FG	LOW DOCKING	FU		GI
	ET		FH	DOCKING	FV	DECEL	GJ
	EU		FI	CORNERING	FW	UNLOAD TAG	GK
	EV		FJ		FX		GL
	EW		FK		FY		GM
	EX		FL		FZ		GN
	EY		FM		GA		GP
	EZ		FN		GB		GQ
	FA		FO	TEST	GC		GR
	FB		FP		GD		GS
	FC		FQ	DEST.	GE		GT
	FD		FR	110 VOLT	GF		GU

① Additional icons are available. Contact your local Eaton Sales Representative.

② SAE Specification No. J1362.

NGR, SVR, E31, E32 and E33 eSM Symbols ①②













Inscription	Catalog Number Suffix	Inscription	Catalog Number Suffix	Inscription	Catalog Number Suffix	Inscription	Catalog Number Suffix
	GV		HM		JD	AUDIO VIDEO	JT
	GW		HN		JE		JU
	GY		HP		JF		JV
	HA		HQ	READ	JG		JW
L	HB		HR	LAMP TEST	JH		JX
R	HC		HS		JJ		JY
CRUISE ON-OFF	HD	ASR AUX	HT	WC	JK		JZ
	HE		HU	WC	JL		KA
	HF		HV		JM	MAX TRAN	KB
LUZ PASILLO	HG	MIRROR CLEAN	HW	wash	JN	REMOTE CONTROL	KC
	HH		HY		JP	TRACTION CONTROL	KD
	HJ	SECUENCIA DE DIAGNOSTICO	JA		JQ	BLINK CODE	KE
DUMP DOOR	HK		JB	km/h	JR	HAND THROT	KF
	HL		JC	TV	JS	ENG DIAG	KG

① Additional icons are available. Contact your local Eaton Sales Representative.

② SAE Specification No. J1362.

NGR, SVR, E31, E32 and E33 eSM Symbols ^{①②}

2

Inscription	Catalog Number Suffix	Inscription	Catalog Number Suffix	Inscription	Catalog Number Suffix
INTARDER	KH	GEN. START	KV	EXIT	LJ
CMU	KI	LOW 12 V.	KW	EXH BRK	LK
	KJ	LOW 110 V.	KX	24V. CHARGER	LL
CRUISE SET	KK	AIR HORN	KY	AQUA HOT	LM
HIGH IDLE	KL	STEP SLIDE	KZ	HEAT EXCHGR	LN
SANDERS	KM		LA	AIR COMPSR	LO
	KN		LB		LP
	KO	CRUISE SELECT	LC		LQ
OVER LOAD DRIVE AXLE	KP	TEST ALARMS	LD		LR
TRACTION CONTROL	KQ		LE		LS
	KR		LF	PA	LT
	KS	AUX HYD OVERHEAT	LG	G-AUX START	LU
12 V. MASTER	KT	VIDEO	LH	CNTR A/C	LV
B/U LIGHTS	KU	ENTER	LI	REAR A/C	LW

① Additional icons are available. Contact your local Eaton Sales Representative.

② SAE Specification No. J1362.

NGR Only Symbols ①②

Inscription	Catalog Number Suffix	Inscription	Catalog Number Suffix	Inscription	Catalog Number Suffix	Inscription	Catalog Number Suffix
	LX	RIGHT SCENE	ML		NB	REAR HEAT	NP
	LY	REAR SCENE	MM		NC	↑ INC.	NQ
POSITION LIGHT	LZ	STOP START	MN		ND	↓ DEC.	NR
MASTER WARN	MA	BATT IGN	MO	FRONT A/C	NE	1 2	NS
UPPER WARN	MB		MP	RETARDER	NF	WHT LT DISABLE	NT
LOWER WARN	MC		MS	OPTCOM	NG		NU
COMPT LIGHTS	MD		MT	FUEL PRIME	NH	LEFT QTZ LT	NV
WORK LIGHTS	ME	TWO TONE HORNS	MU	AERIAL PTO	NI	RIGHT QTZ LT	NW
FAST IDLE	MF	SIREN AMP TWO TONES	MV	AIRHRN HORN	NJ	DECK LIGHT	NX
MIRROR HEAT	MG	PUMP PTO	MW	SIREN HORN	NK	ADD'L STROBE	NY
GEN PTO	MH	CRUISE	MX	Q2B HORN	NL	REAR QTZ LT	NZ
WIGWAG	MI	RES/ACCEL	MY	SIREN Q2B HORN	NM	MODE	PA
SIREN BRAKE	MJ	SET/COAST	MZ	AIRHRN Q2B HORN	NN		PB
LEFT SCENE	MK	RETARD ON/OFF	NA	AIRHRN SIREN HORN	NO		PC

① Additional icons are available. Contact your local Eaton Sales Representative.

② SAE Specification No. J1362.













































NGR Only Symbols ^{①②}

Inscription	Catalog Number Suffix	Inscription	Catalog Number Suffix	Inscription	Catalog Number Suffix	Inscription	Catalog Number Suffix
AUX LIGHTS	PD	VOLUME UP	PS		RG		RW
	PE	VOLUME DOWN	PT	CHECK ENGINE	RH		RX
FRONT BLIND	PF	MUTE ON	PU		RI		RY
SIDE BLIND	PG	MUTE OFF	PV		RJ		RZ
ON	PH		PW		RK		SA
OFF	PI	DISPLAY POWER	PX		RL		SB
GEN STRT STOP/PRHT	PJ	CRUISE ADJ	PY		RM		SC
B.O. SELECT	PK	HILL HOLDER	PZ	ABS CODE	RN		SD
	PL		RA		RP		SE
B.O. LIGHTS	PM	AISLE LAMPS	RB		RQ		SF
LEFT DRV	PN		RC		RS		SG
RIGHT DRV	PP		RD		RT		SH
INVERTER	PQ	OVER LOAD DRIVE AXLE	RE		RU		SJ
	PR		RF		RV		SK

① Additional icons are available. Contact your local Eaton Sales Representative.

② SAE Specification No. J1362.

NGR Only Symbols ①②

Inscription	Catalog Number Suffix	Inscription	Catalog Number Suffix	Inscription	Catalog Number Suffix	Inscription	Catalog Number Suffix
	SL	GPFU	TA		TQ		UE
	SM	CHEM ALARM	TB		TR		UF
Mode	SN		TC		TS		UG
	SP		TD		TT		UH
	SQ		TE		TU		UK
OFF ROAD TRACTION	SR		TF		TV		UL
	SS	OVER LOAD DRIVE AXLE	TG		TW		UM
	ST		TH		TX		UN
INTER-AXLE	SU		TJ		TY		UP
8X8	SV		TK		TZ		UR
	SW		TL		UA		US
	SX		TM		UB		UT
AUX HYD	SY	SUSP RECOVER	TN		UC		UU
HYD ENABLE	SZ		TP		UD		UV

① Additional icons are available. Contact your local Eaton Sales Representative.
② SAE Specification No. J1362.

NGR Only Symbols ^{①②}























2

Inscription	Catalog Number Suffix	Inscription	Catalog Number Suffix	Inscription	Catalog Number Suffix	Inscription	Catalog Number Suffix
	UW		VM		WC	MIRROR HEAT	WT
	UX		VN		WD	OVHD FAN	WU
	UY		VP		WE	CEILING LIGHTS	WV
	UZ	DOOR BYPASS	VR		WF	BATTERY BOOST	WW
	VA	VGT BRK	VS		WG	GENERATOR	WX
	VB	ASI RESET	VT		WH	DRVR SHADE	WY
	VC	CURT. UP	VU		WJ	PEDALS	WZ
	VD	CURT. DOWN	VV		WK	ATC	XA
H/O	VE	BROOM IN	VW		WL	ENGINE BRAKE	XB
	VF	BROOM OUT	VX		WM	SHOCKS	XC
	VG	B.O. LIGHTS	VY		WN	AIR DUMP	XD
REAR	VH	ABS BLINK CODE	VZ		WP	TAG AXLE	XE
OPEN	VK		WA	MIRROR SELECT	WR	FOG LIGHTS	XF
CLOSE	VL	MUD/SNOW TRACTION	WB	T M B	WS	DIMMER	XG

① Additional icons are available. Contact your local Eaton Sales Representative.

② SAE Specification No. J1362.

NGR Only Symbols ①②

Inscription	Catalog Number Suffix	Inscription	Catalog Number Suffix	Inscription	Catalog Number Suffix	Inscription	Catalog Number Suffix
HEADLIGHTS	XH		XY	CTIS	YN	PUMP	ZC
DOCKING LIGHTS	XJ		XZ		YP	ROAD	ZD
AQUA HOT ENGINE PREHEAT	XK		YA		YQ		ZE
ENGINE BLOCK HEAT	XL		YB	IGNITION	YR	UNLOCK	ZF
PORCH LIGHT	XM		YC	ENGINE STOP	YS	LOCK	ZG
HANDLE STEP LIGHTS	XN	SILENT WATCH	YD	ENGINE START	YT	LM OVRRDE	ZH
STEP	XP		YE	CAMERA AIR	YU	E SHUT DWN	ZJ
BAY LIGHTS	XR		YF	WINDOW	YV		ZK
BATT CUTOFF	XS		YG		YW		ZL
STEP COVER	XT		YH	T-CASE LOW	YX		ZM
PASS SHADE	XU	IR SELECT	YJ	TANK 2	YY		ZN
NBC	XV	IR DRIVE	YK	TANK 1	YZ		ZP
AUX SUPPLY	XW	CRUISE	YL		ZA		ZR
	XX	ABS OFF-RD	YM		ZB		ZS

① Additional icons are available. Contact your local Eaton Sales Representative.
② SAE Specification No. J1362.





NGR Only Symbols ^{①②}

Inscription	Catalog Number Suffix	Inscription	Catalog Number Suffix	Inscription	Catalog Number Suffix	Inscription	Catalog Number Suffix
	ZT		H1		Y1	PEDALS	N2
CAMERA	ZU	HP	J1		Z1	GAUGE MODE	P2
VIDEO	ZV	F1	K1		A2	REGEN	R2
	ZW		L1	ATC OFF ROAD	B2	FRONT QTZ LT	S2
	ZX		M1		C2		T2
FRONT BRAKE	ZY		N1	120V	D2		U2
TIRE CHAINS	ZZ		P1	GAUGE UP/DWN	E2		V2
	A1		R1	GAUGE MODE	F2	ECO	W2
400V	B1		S1	ENG AFES	G2		X2
230V	C1		T1	CREW AFES	H2		Y2
MC	D1	FRONT 	U1		J2		Z2
	E1	SIDE / REAR 	V1	ABS DIAG	K2	 EXTERN	A3
	F1	B.O. SELECT	W1	HORN Q2B	L2	 INTERN	B3
	G1	IDLE 	X1	MASTER DUMP	M2	GEN ENGAGE	C3

① Additional icons are available. Contact your local Eaton Sales Representative.

② SAE Specification No. J1362.





NGR Only Symbols ①②

Inscription	Catalog Number Suffix	Inscription	Catalog Number Suffix	Inscription	Catalog Number Suffix	Inscription	Catalog Number Suffix
	D3	AIRHRN ALT AH	T3	ROTO- RAY	H4		Y4
	E3	DIFF LOCK	U3	REGEN	J4		Z4
	F3	HORN AIRHORN SIREN	V3	REGEN INHBT	K4		A5
	G3	MIL	W3		L4		B5
	H3	ATC OVRRDE	X3		M4		C5
	J3	OUTGR LASER	Y3		N4		D5
	K3	AER QTZ LT	Z3	BODY QTZ LT	P4		E5
PEDAL 	L3	FOG LIGHTS	A4		R4		F5
PEDAL 	M3	BATTLE SHORT	B4		S4	AUX PUMP	G5
BAT XOVER	N3	MENU UP	C4	TILT UP 	T4	TST 1	H5
BAT O/RIDE	P3	MENU DOWN	D4	TILT DOWN 	U4	TST 2	J5
	Q3	ARMOR	E4		V4	TST 3	K5
HORN SIREN	R3	NO ARMOR	F4		W4	SAVE	L5
DOME LIGHT	S3	KNEEL	G4		X4	DOOR LOCK	M5

① Additional icons are available. Contact your local Eaton Sales Representative.

② SAE Specification No. J1362.







NGR Only Symbols ^{①②}

Inscription	Catalog Number Suffix	Inscription	Catalog Number Suffix	Inscription	Catalog Number Suffix	Inscription	Catalog Number Suffix
TELMA RTDR	N5	RUMBLER	C6	REAR CHUTE EXTEND	S6	Q2B AIRHORN HORN	G7
SIREN AIRHORN HORN	P5		D6D6	LEFT DUMP OPEN	T6	A	H7
PUMP PANEL LTS	Q5	GRND LT	E6	RIGHT DUMP OPEN	U6	B	J7
REAR HEATER	R5	RED INT LT	F6	REAR DUMP OPEN	V6	SCENE LT	K7
T/G OPEN	S5	WHT INT LT	G6	LEFT CHUTE RETRACT	W6		L7
HYD FILTER	T5	VAC PUMP	H6	RIGHT CHUTE RETRACT	X6	BODY UP	M7
TRANS TEMP	U5	PRESS MODE	J6	REAR CHUTE RETRACT	Y6	BODY DOWN	N7
OIL LEVEL	V5	VENT VALVE	K6	LEFT DUMP CLOSE	Z6	S/S TG RAISE	P7
PUMP	W5	DRIVER VALVE	L6	RIGHT DUMP CLOSE	A7	S/S TG LOWER	Q7
STROBE LIGHT	X5	OFFICER VALVE	M6	REAR DUMP CLOSE	B7	S/S TG LOCK	R7
WORK LIGHT	Y5	REAR VALVE	N6		C7	S/S TG UNLOCK	S7
FLASHING LIGHT	Z5	MASTER POWER	P6	PTO	D7	C/S TG RAISE	T7
CAMERA LIGHT	A6	LEFT CHUTE EXTEND	Q6		E7	C/S TG LOWER	U7
PLATFORM LEVEL	B6	RIGHT CHUTE EXTEND	R6	Q2B SIREN HORN	F7	C/S TG LOCK	V7

① Additional icons are available. Contact your local Eaton Sales Representative.



② SAE Specification No. J1362.

NGR Only Symbols ①②

Inscription	Catalog Number Suffix	Inscription	Catalog Number Suffix	Inscription	Catalog Number Suffix	Inscription	Catalog Number Suffix
C/S TG UNLOCK	W7	BODY RAISED	L8	FLUSH	A9	OFFSIDE AIRHORN OVRRD	Q9
AUTO PACK	X7	TIPPER EXTENDED	M8	TAKEDOWN LIGHTS	B9	OFFSIDE SIREN OVRRD	R9
PACKER EXTEND	Y7	PUMP ON	N8	DEC	C9	OFFSIDE Q2B OVRRD	S9
PACKER RETRACT	Z7	THR ADV	P8	VACUUM POMPE	D9	Q2B SIREN	T9
ONE PACK	A8	AUTO NEUTRAL	Q8	MODE PRESSION	E9	SIREN BRAKE	U9
TWO PACK	B8	HIGH IDLE	R8	VALVE VENTIL.	F9		V9
OUTSIDE CONTROLS	C8	HEATER	S8	VALVE C/ COND.	G9		W9
STREETSIDE TAILGATE	D8	LEFT MIRROR	T8	VALVE C/ OFF.	H9	FLUOR LIGHT	X9
CURBSIDE TAILGATE	E8	RIGHT MIRROR	U8	VALVE ARR.	J9		Y9
TAILGATE RAISE	F8	IR LIGHTS	V8	MAÎTRE	K9		Z9
TAILGATE LOWER	G8	B.O. SPOT LIGHTS	W8	POMPE	L9		1A
TAILGATE LOCK	H8	TANK TO PUMP	X8	LUMIERE TRAVAIL	M9	LOAD LIMIT	1B
TAILGATE UNLOCK	J8	THROT INC	Y8	MAITRE URGENCE	N9		1C
HOPPER FLOOD	K8	FOAM	Z8	LIGHT BAR	P9	OFF ROAD LTS	1D

① Additional icons are available. Contact your local Eaton Sales Representative.
 ② SAE Specification No. J1362.





































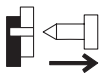

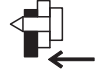



NGR Only Symbols ^{①②}

Inscription	Catalog Number Suffix	Inscription	Catalog Number Suffix	Inscription	Catalog Number Suffix	Inscription	Catalog Number Suffix
STEP LT	1E	ALLEY LT LEFT	1L	PTO ON	1S	RIGHT NOZZLE	1Y
ON OFF	1F	PLOW RAISE	1M	TAIL UP	1T		1Z
Drv Spr Nozzle	1G	PLOW LOWER	1N	OVERRIDE	1U	JAKE BRAKE	2A
Off Spr Nozzle	1H	PLOW FLOAT	1P	COMMAND LIGHT	1V	OIL TEMP	2B
Rem Noz Lt	1J	BACK-UP ALRM OVRRD	1Q	PUMP HEATER(S)	1W		2C
ALLEY LT RIGHT	1K	HOIST UP	1R	LEFT NOZZLE	1X		

^① Additional icons are available. Contact your local Eaton Sales Representative.

^② SAE Specification No. J1362.

SVR, E31, E32 and E33 eSM Symbols ①②

Inscription	Catalog Number Suffix	Inscription	Catalog Number Suffix	Inscription	Catalog Number Suffix	Inscription	Catalog Number Suffix
	LX	SET/CST	MM		NB		NR
	LY	SHDN OVRD	MN		NC		NS
HI RPM	MA	EXHST BRK	MP	TCS 	ND		NT
LOW RPM	MB		MQ		NE		NU
	MC		MR		NF		NV
	MD	AUTO 	MS		NG		NW
TEST (P)	ME		MT		NH		NX
	MF		MU	F	NJ		NY
	MG		MV	N	NK		NZ
	MH		MW	AUX WARN	NL		03
	MI		MX		NM	R	PA
	MJ		MY	I	NN		PB
	MK		MZ	OVER LOAD	NP		PC
RSM/ACC	ML		NA		NQ		PD

① Additional icons are available. Contact your local Eaton Sales Representative.
② SAE Specification No. J1362.

SVR, E31, E32 and E33 eSM Symbols ^{①②}



































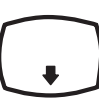







2

Inscription	Catalog Number Suffix	Inscription	Catalog Number Suffix	Inscription	Catalog Number Suffix	Inscription	Catalog Number Suffix
	PE		PT		QH		QX
	PF		PU		QJ		QY
	PG		PV		QK	SET ACCEL	QZ
	PH		PW		QL	RESUME DECEL	RA
	PI		PX		QM		RB
	PJ		PY		QN		RC
	PK		PZ		QP	WINCH	RD
	PL		QA		QQ	CRANE	RE
	PM		QB		QR	AUTO MODE	RF
	PN		QC		QS	MAN MODE	RG
	PP		QD		QT		RH
	PQ		QE		QU		RJ
	PR		QF		QV		RK
	PS		QG		QW		RL

① Additional icons are available. Contact your local Eaton Sales Representative.

② SAE Specification No. J1362.

SVR, E31, E32 and E33 eSM Symbols ①②

Inscription	Catalog Number Suffix	Inscription	Catalog Number Suffix	Inscription	Catalog Number Suffix	Inscription	Catalog Number Suffix
	RM		SB		SR	CLOSE	TF
	RN		SC		SS	OPEN	TG
	RP		SD		ST		TH
	RQ		SE		SU		TJ
	RR		SF		SV	RPM CTRL	TK
	RS		SG		SW	ON	TL
	RT		SH		SX	AUTO	TM
	RU		SJ		SY	HIGH	TN
	RV	ENG DIAG	SK		SZ	LOW	TP
	RW		SL		TA	CHEM ALARM	TQ
	RX		SM		TB	GPFU	TR
	RY		SN		TC		TS
	RZ		SP		TD	LHS	TT
	SA		SQ		TE	AUTO SPNS	TU

① Additional icons are available. Contact your local Eaton Sales Representative.
② SAE Specification No. J1362.

SVR, E31, E32 and E33 eSM Symbols ^{①②}





























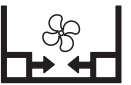





















2

Inscription	Catalog Number Suffix	Inscription	Catalog Number Suffix	Inscription	Catalog Number Suffix	Inscription	Catalog Number Suffix
OBST AVOID	TV		UK		UZ		VP
	TW		UL		VA		VQ
	TX	WINCH	UM		VB		VR
	TY	CRANE	UN	FILTER	VC	FAULT	VS
PRESS CHECK	TZ		UP		VD	OK	VT
RUN FLAT	UA		UQ		VE		VU
CTIS	UB		UR		VF		VV
	UC		US		VG		VW
	UD		UT		VH		VX
	UE	F	UU		VJ		VY
	UF	LH	UV		VK	OFF	VZ
	UG	R	UW		VL	AUTO	WA
	UH	RH	UX		VM		WB
	UJ	AUX HTR	UY		VN		WC

① Additional icons are available. Contact your local Eaton Sales Representative.

② SAE Specification No. J1362.

SVR, E31, E32 and E33 eSM Symbols ①②

Inscription	Catalog Number Suffix	Inscription	Catalog Number Suffix	Inscription	Catalog Number Suffix	Inscription	Catalog Number Suffix
	WD		WT		XJ		YA
	WE		WU		XL		YB
	WF		WV		XM		YC
	WG		WX		XN	SET/RES	YD
	WH		WY	CODE	XP		YE
	WJ		WZ		XQ		YF
	WK		XA		XR		YG
	WL		XB		XS		YH
AUTO	WM		XC		XT		YJ
	WN		XD		XU		YK
	WP	SHIFT	XE		XV		YL
	WQ		XF		XW		YM
	WR		XG		XY		YN
	WS		XH		XZ		YP

① Additional icons are available. Contact your local Eaton Sales Representative.

② SAE Specification No. J1362.

SVR, E31, E32 and E33 eSM Symbols ^{①②}

2

Inscription	Catalog Number Suffix	Inscription	Catalog Number Suffix	Inscription	Catalog Number Suffix	Inscription	Catalog Number Suffix
	YQ		ZE		ZV	ENG COMPT	K1
	YR		ZF		ZW		L1
	YS		ZG		ZX		M1
	YT		ZH		ZY	ISO	N1
	YU		ZJ		ZZ	H	P1
	YV		ZK		A1		R1
	YW		ZL		B1		S1
	YX		ZM		C1		T1
	YY		ZN		D1		U1
	YZ		ZP		E1		V1
	ZA		ZR	RPM -	F1		W1
	ZB		ZS	RPM +	G1	DRIVER VALVE	X1
	ZC		ZT		H1	OFFICER VALVE	Y1
	ZD		ZU		J1	REAR VALVE	Z1

① Additional icons are available. Contact your local Eaton Sales Representative.

② SAE Specification No. J1362.

SVR, E31, E32 and E33 eSM Symbols ①②











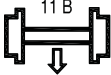





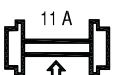



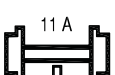

Inscription	Catalog Number Suffix	Inscription	Catalog Number Suffix	Inscription	Catalog Number Suffix	Inscription	Catalog Number Suffix
ISO	A2		R2		G3		U3
H	B2		S2		H3		V3
	C2		T2		I3	AUTO	W3
HP	D2		U2		J3		X3
HF	E2		V2		K3		Y3
	F2		W2		L3		Z3
	G2		X2		M3		A4
	H2	PUMP COMP LT	Y2		N3		B4
O/D OFF	J2		Z2		O3		C4
	K2		A3		P3		D4
	L2		B3		Q3		E4
APG	M2		C3		R3		F4
ePTO	N2		D3		S3		G4
	P2		F3		T3		H4

① Additional icons are available. Contact your local Eaton Sales Representative.

② SAE Specification No. J1362.

SVR, E31, E32 and E33 eSM Symbols ^{①②}

2

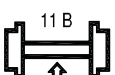
Inscription	Catalog Number Suffix	Inscription	Catalog Number Suffix	Inscription	Catalog Number Suffix	Inscription	Catalog Number Suffix
	I4		P4		V4		B5
	J4		Q4		W4		C5
	K4		R4		X4		D5
	L4		S4		Y4		X5
	M4		T4		Z4		X6
	N4		U4		A5		X7
	O4						

① Additional icons are available. Contact your local Eaton Sales Representative.

② SAE Specification No. J1362.